

# TAPPING SCREWS

Listed According To Size

**Sec. 1**



## Phillips Oval Head Tapping Screws

Size	Zinc Part No.	Chrome Part No.	Bk. Oxide Part No.	Unit Pkg.	Size	Zinc Part No.	Chrome Part No.	Bk. Oxide Part No.	Unit Pkg.
4 x 3/8"	3062	3067	12893	100	10 x 1"	6 Hd	2729	1804	100
4 x 1/2"	3063	3068	12894	100	10 x 1"	8 Hd	2578	2730	11089
4 x 5/8"		5604	12895	100	10 x 1"		2582	2731	11088
4 x 3/4"		3069	12896	100	10 x 1-1/8"			1807	100
4 x 1"	3065	3070	12897	100	10 x 1-1/4"	6 Hd		2733	100
6 x 3/8"		2802		100	10 x 1-1/4"	8 Hd	2661	2734	11091
6 x 1/2"	2571	2698	12795	100	10 x 1-1/4"		2583	2735	11090
6 x 5/8"	2699	1793		100	10 x 1-1/2"	6 Hd		2046	100
6 x 3/4"	2700	1794	12796	100	10 x 1-1/2"	8 Hd	2662	20374	11093
6 x 7/8"	2572			100	10 x 1-1/2"		2585		11092
6 x 1"	2702	1796	12797	100	10 x 1-3/4"	6 Hd		2047	100
6 x 1-1/4"	2704	1797	12798	100	10 x 1-3/4"	8 Hd	2663		100
8 x 3/8"		2705	2024	100	10 x 1-3/4"		2586		100
8 x 3/8"	3484	3485		100	10 x 2"	8 Hd	2665		100
8 x 1/2"	2706	2027	10162	100	10 x 2"		2666		100
8 x 1/2"	2358	2707	10163	100	10 x 2-1/2"		3207		100
8 x 5/8"	2708	1421		100	12 x 1/2"		8044		100
8 x 5/8"	2574	2709		100	12 x 3/4"	10 Hd	8049		100
8 x 3/4"	1798	1799	10164	100	12 x 3/4"		8050		100
8 x 3/4"	2359	2710	10165	100	12 x 1"	10 Hd	8055		100
8 x 3/4"		20373		100	12 x 1"		8056		100
8 x 7/8"	1800	2711		100	12 x 1-1/4"	8 Hd	8057		100
8 x 7/8"	2575	2712		100	12 x 1-1/4"		8059		100
8 x 1"	1801	1483	10166	100	12 x 1-1/2"	10 Hd	8061		100
8 x 1"	2360	2713	10167	100	12 x 1-1/2"		8062		100
8 x 1-1/8"	2714	1802		100	12 x 2"		8068		100
8 x 1-1/8"		2715		100	14 x 1"		8083		100
8 x 1-1/4"	1803	1423	10168	100					
8 x 1-1/4"	2361	2716	10169	100					
8 x 1-1/2"	2717	1932	10170	100					
8 x 1-1/2"		1424		100					
(Special Long Shank)									
8 x 1-1/2"	2362	2718	10171	100					
8 x 1-3/4"		1933		100					
8 x 1-3/4"	2631			100					
8 x 2"	2632			100					
8 x 2"	2633			100					
8 x 2-1/4"	3203			100					
8 x 2-1/2"	3204			100					
8 x 2-1/2"	3205			100					
10 x 1/2"	2720	2656		100					
10 x 1/2"		2657	11085	100					
10 x 1/2"	2579	2722	11084	100					
10 x 5/8"		2658		100					
10 x 5/8"		2724		100					
10 x 5/8"	2580	2725		100					
10 x 3/4"	2726	2659		100					
10 x 3/4"	2727	1717	11087	100					
10 x 3/4"	2581	2728	11086	100					



## Phillips Oval Head Tek<sup>®</sup> Tapping Screws

Phosphate

Auveco Part No.	Size	Unit Pkg.
16735	8 x 3/4"	6 Hd.....100
16736	8 x 1"	6 Hd.....50
16737	8 x 1-1/4"	6 Hd.....50

# Sec. 1

# TAPPING SCREWS

Listed According To Size

## Pop On Polypropylene Screw Covers & Bases

They're simple to use:

1. Place washer over pilot or starting hole for screw, nail or rivet.
2. Install fastener.
3. Place Snap Cap over washer at slight angle.
4. Simply push Snap Cap down firmly.

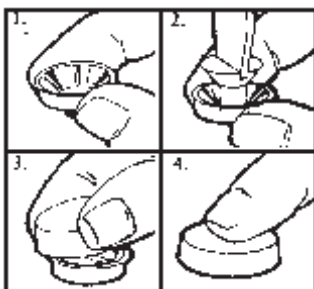

### Covers



Auveco Part No.	Screw Size	Color	O.D.	Unit Pkg.
13831	#4	Black	1/2"	50
13832	#4	White	1/2"	50
13833	#6	Black	1/2"	50
13834	#6	White	1/2"	50
13835	#8	Black	5/8"	50
13836	#8	White	5/8"	50
13837	#10	Black	5/8"	50
13838	#10	White	5/8"	50

### Bases



Auveco Part No.	Screw Size	Use with Cover	Unit Pkg.
13839	#4	13831 & 13832	50
13840	#6	13833 & 13834	50
13841	#8	13835 & 13836	50
13842	#10	13837 & 13838	50



## Phillips Flat Head Tapping Screws

Size	Zinc Part No.	Unit Pkg.	Bk. Oxide Part No.	Unit Pkg.
4 x 1/4"	5646	100		
4 x 3/8"	5647	100	12899	100
4 x 1/2"	5648	100	12900	100
4 x 5/8"	5649	100		
4 x 3/4"	5650	100		
6 x 5/16" .4 Hd.	2736	100		
6 x 1/2" .4 Hd.	5651	100		
6 x 1/2"	1946	100	12801	100
6 x 5/8"	5653	100		
6 x 3/4" .4 Hd.	*2803	100		
6 x 3/4"		12802		100
6 x 1"		12803		100
	* Chrome			
8 x 3/8"	5654	100		
8 x 7/16" .6 Hd.	1479	100		
8 x 1/2" .5 Hd.	1711	100		
8 x 1/2" .6 Hd.	2804	100	10173	100
8 x 1/2"	5655	100	10172	100
8 x 5/8" .6 Hd.	5656	100		
8 x 3/4" .6 Hd.	1712	100	10174	100
8 x 3/4"	2807	100	10175	100
8 x 1" .6 Hd.	5660	100	10176	100
8 x 1"	5661	100	10177	100
8 x 1-1/4" .6 Hd.			10178	100
8 x 1-1/4"			10179	100
8 x 1-1/2" .6 Hd.			12805	50
8 x 1-1/2"			12806	50
10 x 1/2"			12807	100
10 x 3/4"	2810	100	12809	100
10 x 1"	5672	100	12811	50

## Slotted Oval Head Tapping Screws



Bright Zinc Chromate

Auveco Part No.	Size	Unit Pkg.	Auveco Part No.	Size	Unit Pkg.
1432	6 x 1/2"	100	5616	12 x 5/8"	100
1144	6 x 5/8"	100	3483	12 x 7/8"	100
1148	8 x 5/8"	100	2457	12 x 1"	100
1149	8 x 3/4"	100	5617	14 x 5/8"	100
1137	8 x 1"	100	5618	14 x 2-1/4"	100
1091	10 x 3/4"	100			
1450	10 x 1-1/2"	100			

# TAPPING SCREWS

## Sec. 1



### Phillips Pan Head Tapping Screws

Size	Zinc Part No.	Unit Pkg.	Bk. Oxide Part No.	Unit Pkg.
4 x 1/4"	3071	100	12902	100
4 x 3/8"	3072	100	12903	100
4 x 1/2"	3073	100	12904	100
4 x 5/8"	5619	100		
4 x 3/4"	3074	100	12905	100
4 x 1"	3075	100		
6 x 1/4"	1935	100		
6 x 3/8"	1936	100	16889	100
6 x 1/2"	1937	100	11917	100
6 x 5/8"	5621	100		
6 x 3/4"	2364	100	11918	100
6 x 1"	3076	100	11919	100
6 x 1-1/8"	5623	100		
6 x 1-1/4"	3077	100	11920	100
6 x 1-1/2"	3078	100		
8 x 3/8"	1939	100		
8 x 1/2"	1940	100	10180	100
8 x 5/8"	5625	100		
8 x 3/4"	2365	100	10181	100
8 x 7/8"	5626	100		
8 x 1"	3079	100	10182	100
8 x 1-1/4"	3080	100	10183	100
8 x 1-1/2"	3081	100	12799	50
8 x 1-3/4"	2088*	100		
* Chrome				
10 x 3/8"	1942	100		
10 x 1/2"	1943	100	11921	100
10 x 5/8"	2808	100		
10 x 3/4"	2366	100	11922	100
10 x 7/8"	5629	100		
10 x 1"	3082	100	11923	50
10 x 1-1/4"	3083	100	11924	50
10 x 1-1/2"	3084	100	12800	50
12 x 1/2"	3085	100		
12 x 5/8"	5630	100		
12 x 3/4"	2367	100		
12 x 1"	3086	100		
12 x 1-1/4"	3087	100		
12 x 1-1/2"	3088	100		
14 x 1/2"	3089	100		
14 x 5/8"	5632	100		
14 x 3/4"	3090	100		
14 x 7/8"	5633	100		
14 x 1"	3091	100		
14 x 1-1/4"	3092	100		
14 x 1-1/2"	3093	100		
14 x 1-3/4"	3211	100		
14 x 2"	5634	100		
14 x 2-1/4"	2371	50		

For assortments of Phillips Pan Head Tapping Screws refer to Fix Kits 6004 and 6038 in the green pages.



### Slotted Pan Head Tapping Screws Bright Zinc Chromate

Auveco Part No.	Size	Unit Pkg.
3020	4 x 1/4"	100
3022	4 x 1/2"	100
5636	4 x 7/8"	100
3024	4 x 1"	100
1728	6 x 1/4"	100
1263	6 x 3/8"	100
1452	6 x 1/2"	100
1453	6 x 5/8"	100
1454	6 x 3/4"	100
1455	6 x 1"	100
5639	6 x 1-3/8"	100
1456	8 x 3/8"	100
1146	8 x 1/2"	100
1092	8 x 5/8"	100
1147	8 x 3/4"	100
1457	8 x 1"	100
3028	8 x 1-1/2"	100
1730	10 x 3/8"	100
1458	10 x 1/2"	100
1787	10 x 5/8"	100
1265	10 x 3/4"	100
1459	10 x 1"	100
1460	10 x 1-1/2"	100
1266	10 x 1-3/4"	100
1343	12 x 1/2"	100
5642	12 x 5/8"	100
1344	12 x 3/4"	100
1346	12 x 1"	100
3032	12 x 1-1/2"	100
1347	14 x 1/2"	100
2039	14 x 5/8"	100
1381	14 x 3/4"	100
1382	14 x 1"	100
3036	14 x 1-1/2"	100
3037	14 x 1-3/4"	100
5645	14 x 2-1/4"	100

For assortments of Slotted Pan Head Screws refer to Fix Kits 6001 and 6500 in the green pages.

# Sec. 1

# TAPPING SCREWS

Listed According To Size



## Phillips Oval Head Sems® Countersunk Washer Tapping Screws

Size	Chrome Part No.	Unit Pkg.	Bk. Phos Part No.	Unit Pkg.
6 x 5/8".....	<b>3537</b>	100	<b>11784</b>	100
6 x 3/4".....	<b>3538</b>	100	<b>11785</b>	100
6 x 1".....	<b>3539</b>	100	<b>11786</b>	100
8 x 1/2".....6 Hd.....			<b>*16930</b>	100
8 x 5/8".....6 Hd.....	<b>2771</b>	100	<b>11787</b>	100
8 x 3/4".....6 Hd.....	<b>2751</b>	100	<b>11788</b>	100
8 x 1".....6 Hd.....	<b>2772</b>	100	<b>11789</b>	100
8 x 1-1/4".....6 Hd.....	<b>2773</b>	100	<b>11790</b>	100
8 x 1-1/2".....6 Hd.....	<b>14970</b>	50		
10 x 5/8".....8 Hd.....	<b>3465</b>	100	<b>14972</b>	100
10 x 3/4".....8 Hd.....	<b>3466</b>	100	<b>11791</b>	50
10 x 1".....8 Hd.....	<b>3467</b>	100	<b>11792</b>	50
10 x 1-1/4".....8 Hd.....	<b>3468</b>	100	<b>14973</b>	50

\* Black Oxide Finish

For an assortment of Chrome Plated Phillips Oval Head Sems® Countersunk Washer Tapping Screws see Fix-Kit No.6049.



## Phillips Oval Head Sems® Flush Washer Tapping Screws

Size	Chrome Part No.	Bk Oxide Part No.	Unit Pkg.
8 x 1/2".....6 Hd.....		<b>12956</b>	100
8 x 5/8".....6 Hd.....	<b>2774</b>	<b>10652</b>	100
8 x 11/16".....6 Hd.....		<b>10653</b>	100
8 x 7/8".....6 Hd.....	<b>2775</b>		100
8 x 1".....6 Hd.....		<b>12957</b>	100
8 x 1-1/4".....6 Hd.....		<b>10654</b>	100
10 x 1".....8 Hd.....		<b>17657</b>	50



Countersunk



Flush

## Phillips Oval Head Sems® Teks® Finishing Screws With No. 6 Head & No. 2 Drill Point

Size	Washer Type	Chrome Part No.	Phos. Part No.	Statuary Bronze Part No.	Unit Pkg.
8 x 5/8".....Flush.....		<b>11448</b>	<b>11453</b>		100
8 x 5/8".....Ctrsnk.....		<b>11449</b>	<b>11454</b>		100
8 x 3/4".....Flush.....			<b>20513</b>		100
8 x 3/4".....Ctrsnk.....		<b>11450</b>	<b>11455</b>	<b>11460</b>	100
8 x 1".....Ctrsnk.....		<b>11451</b>	<b>11456</b>		50
8 x 1-1/4".....Ctrsnk.....		<b>11452</b>	<b>11457</b>		50
8 x 1-1/4".....Flush.....			<b>18460</b>		50



## Phillips Flat Top Washer Head Tapping Screws

Black E-Coat or Zinc

Size	Washer Head O.D.	Zinc Part No.	Black E-Coat Part No.	Unit Pkg.
6 x 1/2".....	3/8"		<b>12950</b>	100
6 x 3/4".....	3/8"		<b>*12951</b>	100
6 x 1".....	3/8"		<b>*12952</b>	100
8 x 1/2".....	13/32"	<b>14859</b>	<b>12213</b>	100
8 x 5/8".....	13/32"	<b>14860</b>	<b>12214</b>	100
8 x 3/4".....	13/32"	<b>14861</b>	<b>12215</b>	100
8 x 1".....	13/32"	<b>14862</b>	<b>12216</b>	100
8 x 1-1/4".....	13/32"		<b>12217</b>	50
8 x 1-1/2".....	13/32"		<b>12218</b>	50
8 x 2".....	13/32"		<b>19798</b>	50
10 x 3/4".....	15/32"		<b>12953</b>	50
10 x 1".....	15/32"		<b>12954</b>	50
10 x 1-1/4".....	15/32"		<b>12955</b>	50

\*Black Oxide

Black E-Coat Is Excellent For Interior/Exterior Use.  
168 Hour Salt Spray



## Phillips Pan Head Sems® Tapping Screws

Black Phosphate

Auveco Part No.	Size	Washer O.D.	Unit Pkg.
<b>12818</b>	8 x 1/2"	1/2"	50
<b>12820</b>	8 x 3/4"	1/2"	50
<b>12821</b>	8 x 1"	1/2"	50

# TAPPING SCREWS

Listed According To Size

**Sec. 1**



## Torx® Oval Head Tapping Screws

Zinc Plated

Auveco Part No.	Size	Drive Size	Unit Pkg.
<b>12016</b>	.....8 x 1"	.....T-20	.....50



## Flat Head Torx® Drive Floor Screws

Thread Cutting Screws - Type F  
Phosphate & Oil Finish

Auveco Part No.	Size	Bit Size	Unit Pkg.
<b>12098</b>	1/4-20 x 2"	T-30	50
<b>12099</b>	1/4-20 x 2-1/4"	T-30	50
<b>12100</b>	1/4-20 x 2-1/2"	T-30	50

**Please Order  
In Unit Package Quantity  
Not Pieces**



## Metric Torx® Head Tapping Screws

300 Series Stainless Steel

Auveco Part No.	Size	Head Style	Finish	Unit Pkg.
<b>14572</b>	.....4.2 x 13mm	.....M8 Pan	.....Chrome	.....50
<b>14052</b>	.....4.2 x 16mm	.....M8 Pan	.....Black Ox	.....50
<b>11937</b>	.....4.2 x 20mm	.....M7 Oval	.....Chrome	.....50
<b>11938</b>	.....4.2 x 20mm	.....M7 Oval	.....Black Ox	.....50
<b>14950</b>	.....4.2 x 20mm	.....M8 Oval	.....Chrome	.....50
<b>11943</b>	.....4.2 x 20mm	.....M8 Pan	.....Chrome	.....50
<b>11944</b>	.....4.2 x 20mm	.....M8 Pan	.....Black Ox	.....50
<b>14046</b>	.....4.2 x 25mm	.....M8 Pan	.....Black Ox	.....50
<b>14051</b>	.....4.2 x 20mm	.....M8 Pan	.....Black Ox	.....50
	12mm Washer O.D. Sems®			
<b>14049</b>	.....4.2 x 25mm	.....M8 Pan	.....Chrome	.....50
<b>14053</b>	.....4.2 x 25mm	.....M7 Oval	.....Black Ox	.....50
<b>14569</b>	.....4.2 x 25mm	.....M7 Oval	.....Chrome	.....50
<b>11939</b>	.....4.2 x 30mm	.....M7 Oval	.....Chrome	.....50
<b>11940</b>	.....4.2 x 30mm	.....M7 Oval	.....Black Ox	.....50
<b>14050</b>	.....4.2 x 30mm	.....M8 Pan	.....Black Ox	.....50
<b>11945</b>	.....4.2 x 35mm	.....M8 Pan	.....Chrome	.....25
<b>14047</b>	.....4.2 x 35mm	.....M7 Oval	.....Black Ox	.....50
<b>11941*</b>	.....4.2 x 40mm	.....M7 Oval	.....Chrome	.....25
<b>14952*</b>	.....4.2 x 55mm	.....M8 Pan	.....Black Ox	.....50

\* Not Fully Threaded

For an assortment of Metric Torx® Tapping Screws see Kit No. 6171.



## Torx® Insert Bits For Torx® Screws 1" Shank

Auveco Part No.	Bit Size	For Screw Size	Unit Pkg.
<b>12472</b>	T-10	No. 4	1
<b>11949</b>	T-15	No. 6, 8, M4.2	1
<b>11950</b>	T-20	No. 8, M4.2	1
<b>12103</b>	T-25	No. 10	1
<b>14913</b>	T-27	No. 12, 1/4"	1
<b>12104</b>	T-30	1/4"	1
<b>12105</b>	T-40	5/16"	1
<b>14914*</b>	T-45	3/8", 7/16"	1
<b>14915*</b>	T-50	7/16", 1/2"	1
<b>14916*</b>	T-55	1/2", 9/16", 5/8"	1

\*1-1/4" Shank

### Torx® Tools

Torx® Short Arm Key, Power Drive Bits and Hand Drivers are available for installing Torx® Screws. Refer to the "Tools" listing in the Alphabetical Index.

**Sec. 1**

**TAPPING SCREWS**

Listed According To Size



**Slotted Pan Head  
Thread Cutting  
Screws - Type "F"**

Bright Zinc Chromate

Auveco Part No.	Size	Unit Pkg.
5290	8-32 x 1/4"	100
5291	8-32 x 3/8"	100
5292	8-32 x 1/2"	100
5294	8-32 x 3/4"	100
5298	10-24 x 3/8"	100
5301	10-24 x 3/4"	100
5303	10-24 x 1"	100
5307	1/4-20 x 5/8"	100



**Acorn Indented Hex Washer Head  
Tapping Screws  
With Phillips Recess**

Auveco Part No.	Size	Hex Size	Washer O.D.	Finish	Unit Pkg.
13726	6 ..x 1/2"	1/4"	5/16"	Zinc	100
13736	6 ..x 1/2"	1/4"	5/16"	Blk Phos.	100
13727	6 ..x 3/4"	1/4"	5/16"	Zinc	100
13728	6 ..x 1"	1/4"	5/16"	Zinc	100

**Hexagon Washer Head  
Thread Cutting Screws - Type "F"**

Bright Zinc Chromate

Auveco Part No.	Size	Hex Size	Unit Pkg.
5759	6-32 x 3/8"	1/4"	100
5764	6-32 x 1"	1/4"	100
5766	8-32 x 3/8"	1/4"	100
5767	8-32 x 1/2"	1/4"	100
5768	8-32 x 5/8"	1/4"	100
5769	8-32 x 3/4"	1/4"	100
5773	10-24 x 3/8"	5/16"	100
5774	10-24 x 1/2"	5/16"	100
5775	10-24 x 5/8"	5/16"	100
5776	10-24 x 3/4"	5/16"	100
5778	10-24 x 1"	5/16"	100
8437	12-24 x 1/2"	5/16"	100
8438	12-24 x 3/4"	5/16"	100
8439	12-24 x 1"	5/16"	100
5781	1/4-20 x 3/8"	3/8"	100
5782	1/4-20 x 1/2"	3/8"	100
5783	1/4-20 x 5/8"	3/8"	100
5784	1/4-20 x 3/4"	3/8"	100
5786	1/4-20 x 1"	3/8"	100
5787	1/4-20 x 1-1/4"	3/8"	100
15354	1/4-20 x 1-1/2"	3/8"	50
8441	5/16-18 x 1/2"	1/2"	100
8442	5/16-18 x 3/4"	1/2"	100
8443	5/16-18 x 1"	1/2"	100
8444	5/16-18 x 1-1/4"	1/2"	100
15355	5/16-18 x 1-1/2"	1/2"	50
15356	5/16-18 x 1-3/4"	1/2"	50
11294	3/8-16 x 3/4"	9/16"	50
11295	3/8-16 x 1"	9/16"	50
11296	3/8-16 x 1-1/4"	9/16"	25
11297	3/8-16 x 1-1/2"	9/16"	25
15357	3/8-16 x 1-3/4"	9/16"	25
15358	3/8-16 x 2"	9/16"	25

**TRI-LOBULAR "TT" SCREWS**

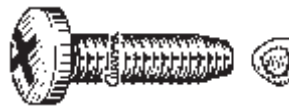

Thread Cutting • Grade 5 • Zinc Plated

Auveco Part No.	Size	Unit Pkg.
16490	8-32 x 1/2"	100
16491	8-32 x 3/4"	100
16492	8-32 x 1"	100
16493	10-24 x 1/2"	100

**Phillips Pan Head**

16490	8-32 x 1/2"	100
16491	8-32 x 3/4"	100
16492	8-32 x 1"	100
16493	10-24 x 1/2"	100

# TAPPING SCREWS

**Sec. 1**

Listed According To Size



## Teks® Self-Drilling Self-Tapping Screws

Size	Hex Size	Zinc Part No.	Unit Pkg.	Bk. Oxide Part No.	Unit Pkg.
<b>Phillips Pan Head</b>					
#2 Teks® Point					
8 x 7/16"		<b>9604</b>	100		
8 x 1/2"		<b>9605</b>	100	<b>16033</b>	100
8 x 3/4"		<b>9606</b>	100	<b>16034</b>	100
8 x 1"		<b>11904</b>	100	<b>16035</b>	50
10 x 1/2"		<b>9607</b>	100	<b>16036</b>	50
10 x 3/4"		<b>9608</b>	100	<b>16037</b>	50
10 x 1"		<b>9609</b>	100	<b>16038</b>	50
12 x 1"		<b>11905</b>	50		
<b>Hex Washer Head</b>					
#2 Teks® Point					
8 x 7/16" .1/4"		<b>9610</b>	100		
8 x 1/2" .1/4"		<b>9611</b>	100	<b>16039</b>	100
8 x 3/4" .1/4"		<b>9612</b>	100	<b>16040</b>	100
8 x 1" .1/4"		<b>11906</b>	100	<b>16041</b>	50
8 x 1-1/4" .1/4"		<b>11907</b>	50		
8 x 1-1/2" .1/4"		<b>11908</b>	50		
10 x 1/2" .5/16"		<b>9613</b>	100	<b>16042</b>	50
10 x 5/8" .5/16"		<b>9614</b>	100		
10 x 3/4" .5/16"		<b>9615</b>	100	<b>16043</b>	50
10 x 1" .5/16"		<b>9616</b>	100	<b>16044</b>	50
<b>Super Teks® - Hex Washer Head</b>					
#3 Teks® Point					
10 x 1-1/4" .5/16"		<b>11909</b>	50		
10 x 1-1/2" .5/16"		<b>11910</b>	50		
12 x 3/4" .5/16"		<b>9617</b>	100		
12 x 1" .5/16"		<b>11911</b>	25		
12 x 1-1/4" .5/16"		<b>11912</b>	25		
12 x 1-1/2" .5/16"		<b>11913</b>	25		
14 x 3/4" .3/8"		<b>9620</b>	100		
14 x 1" .3/8"		<b>11914</b>	25		
14 x 1-1/4" .3/8"		<b>11915</b>	25		
14 x 1-1/2" .3/8"		<b>11916</b>	25		

Teks® Point Material Thickness		
Screw Size	#2 Point	#3 Point
#8	.035" - .100"	.100" - .140"
#10	.035" - .110"	.110" - .175"
#12	.035" - .140"	.110" - .210"
#14	.035" - .175"	.110" - .210"

For an assortment of Teks® Tapping Screws see Fix-Kit No. 6144 in the green pages.



## Indented Hex Head Tapping Screws

Bright Zinc Chromate

Auveco Part No.	Size	Hex Size	Unit Pkg.
<b>2368</b>	8 x 3/8"	1/4"	100
<b>2389</b>	8 x 1/2"	1/4"	100
<b>5676</b>	8 x 5/8"	1/4"	100
<b>2485</b>	8 x 3/4"	1/4"	100
<b>2486</b>	8 x 1"	1/4"	100
<b>3212</b>	8 x 1-1/4"	1/4"	100
<b>8011</b>	10 x 1/2"	5/16"	100
<b>2487</b>	10 x 3/4"	5/16"	100
<b>2488</b>	10 x 1"	5/16"	100
<b>3214</b>	10 x 1-1/4"	5/16"	100
<b>3215</b>	10 x 1-1/2"	5/16"	100
<b>1780</b>	12 x 1/2"	5/16"	100
<b>2107</b>	12 x 3/4"	5/16"	100
<b>3216</b>	12 x 1"	5/16"	100
<b>3217</b>	12 x 1-1/4"	5/16"	100
<b>5682</b>	12 x 2"	5/16"	100
<b>2012</b>	14 x 1/2"	3/8"	100
<b>2391</b>	14 x 5/8"	3/8"	100
<b>1781</b>	14 x 3/4"	3/8"	100
<b>2109</b>	14 x 3/4"	7/16"	100
<b>2266</b>	14 x 1"	7/16"	100
<b>2267</b>	14 x 1-1/4"	7/16"	100
<b>3219</b>	14 x 1-1/2"	7/16"	100
<b>5685</b>	14 x 2"	7/16"	100
<b>2110</b>	5/16 x 3/4"	1/2"	100
<b>2268</b>	5/16 x 1"	1/2"	100
<b>2269</b>	5/16 x 1-1/4"	1/2"	100
<b>3220</b>	5/16 x 1-1/2"	1/2"	100
<b>5690</b>	5/16 x 2"	1/2"	100
<b>5329</b>	3/8 x 3/4"	9/16"	50
<b>5330</b>	3/8 x 1"	9/16"	50
<b>5331</b>	3/8 x 1-1/4"	9/16"	50
<b>5332</b>	3/8 x 1-1/2"	9/16"	50



## Phillips Oval Head Teks® Tapping Screws

Phosphate

Auveco Part No.	Size	Unit Pkg.
<b>16735</b>	8 x 3/4" .6 Hd.	100
<b>16736</b>	8 x 1" .6 Hd.	50
<b>16737</b>	8 x 1-1/4" .6 Hd.	50

# Sec. 1

# TAPPING SCREWS

Listed According To Size



## Hexagon Washer Head Tapping Screws (Washer Attached Solid To Head)

Size	Hex Size	Zinc Part No.	Unit Pkg.	Bk Oxide Part No.	Unit Pkg.
10 x 1/2"	5/16"	2369	100	16149	100
10 x 5/8"	5/16"	2809	100		
12 x 1/2"	5/16"	3474	100		
12 x 5/8"	5/16"	2967	100		
12 x 3/4"	5/16"	2968	100		
12 x 1"	5/16"	2969	100		
14 x 1/2"	3/8"	9825	100		
14 x 5/8"	3/8"	2370	100		
14 x 3/4"	3/8"	2330	100	16152	100
14 x 3/4"	7/16"	2973	100		
14 x 1"	7/16"	2974	100		
14 x 1-1/4"	7/16"	2975	100		
14 x 1-1/2"	3/8"	2976	100		
5/16 x 5/8"	7/16"	2977	100		
5/16 x 3/4"	7/16"	2978	100		
5/16 x 1"	7/16"	2979	100		
5/16 x 1-1/4"	7/16"	2980	100		
5/16 x 1-1/2"	7/16"	2981	100		



## Hexagon Head Sems® Tapping Screws (Washer Loose From Head)

Bright Zinc Chromate

Auveco Part No.	Size	Hex Size	Washer O.D.	Unit Pkg.
2983	12 x 3/4"	7/16"	5/8"	100
2604	14 x 3/4"	3/8"	5/8"	100
2988	14 x 3/4"	7/16"	21/32"	100
2605	14 x 1"	3/8"	21/32"	100
2989	14 x 1"	7/16"	21/32"	100
2991	14 x 1-1/2"	7/16"	21/32"	100
2994	5/16 x 1"	7/16"	11/16"	100
2996	5/16 x 1-1/2"	7/16"	11/16"	100



## Slotted Hexagon Head Tapping Screws

Bright Zinc Chromate

Auveco Part No.	Size	Hex Size	Unit Pkg.
3342	6 x 3/4"	1/4"	100
3350	8 x 1"	1/4"	100
3352	10 x 3/8"	5/16"	100
3353	10 x 1/2"	5/16"	100
3355	10 x 3/4"	5/16"	100



## Slotted Hexagon Washer Head Tapping Screws

Bright Zinc Chromate

Auveco Part No.	Size	Hex Size	Unit Pkg.
3367	6 x 3/8"	1/4"	100
3368	6 x 1/2"	1/4"	100
3369	6 x 5/8"	1/4"	100
3370	6 x 3/4"	1/4"	100
3373	8 x 3/8"	1/4"	100
3374	8 x 1/2"	1/4"	100
3375	8 x 5/8"	1/4"	100
3376	8 x 3/4"	1/4"	100
3378	8 x 1"	1/4"	100
3379	8 x 1-1/4"	1/4"	100
3380	10 x 3/8"	5/16"	100
3381	10 x 1/2"	5/16"	100
3382	10 x 5/8"	5/16"	100
3383	10 x 3/4"	5/16"	100
3385	10 x 1"	5/16"	100
3386	10 x 1-1/4"	5/16"	100
3387	10 x 1-1/2"	5/16"	100
3388	12 x 1/2"	5/16"	100
3389	12 x 5/8"	5/16"	100
3390	12 x 3/4"	5/16"	100
3392	12 x 1"	5/16"	100
3393	12 x 1-1/4"	5/16"	100
3394	12 x 1-1/2"	5/16"	100

For an assortment of Slotted Hexagon Washer Head Tapping Screws see Fix-Kit No. 6025 in the green pages..



## SCREWS



### Drill Screws

Bright Zinc Chromate  
Pinch Point Slotted Hex Washer Head  
Tapping Screws

Auveco Part No.	Size	Hex Size	Unit Pkg.
<b>3367</b>	6 x 3/8"	1/4"	100
<b>3374</b>	8 x 1/2"	1/4"	100
<b>3376</b>	8 x 3/4"	1/4"	100

Use Auveco Magnetic Socket Tool No. 7767



### Self-Piercing Screws Zinc

For material thickness up to .060  
Use with magnetic chuck 7767

Auveco Part No.	Size	Hex Size	Unit Pkg.
<b>12365</b>	7 x 1/2"	1/4"	100
<b>12367</b>	8 x 5/8"	1/4"	100
<b>12368</b>	8 x 3/4"	1/4"	50
<b>12369</b>	10 x 1/2"	1/4"	50
<b>12370</b>	10 x 3/4"	1/4"	50

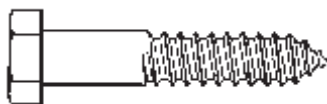

### Hex Head Lag Screws Zinc Plated

Auveco Part No.	Size	Hex Size	Unit Pkg.
<b>9085</b>	1/4 x 2"	7/16"	50
<b>9087</b>	1/4 x 3"	7/16"	50
<b>9090</b>	5/16 x 2"	1/2"	50
<b>9091</b>	5/16 x 2-1/2"	1/2"	50
<b>9092</b>	5/16 x 3"	1/2"	50
<b>9095</b>	5/16 x 5"	1/2"	25
<b>9100</b>	3/8 x 4"	9/16"	25
<b>9101</b>	3/8 x 5"	9/16"	25

## WOOD SCREWS

**Sec. 1**



### Plain Brass Phillips Flat Head Wood Screws

Auveco Part No.	Size	Unit Pkg.
<b>3565</b>	4 x 1/2"	100
<b>3566</b>	4 x 3/4"	100
<b>3568</b>	6 x 1/2"	100
<b>3570</b>	6 x 1"	100
<b>3571</b>	6 x 1-1/4"	100
<b>3575</b>	8 x 1-1/4"	100
<b>3578</b>	10 x 3/4"	100
<b>3581</b>	10 x 1-1/2"	100



### Phillips Flat Head Wood Screws Steel - Zinc Plated

Auveco Part No.	Size	Unit Pkg.
<b>9555</b>	6 x 1/2"	100
<b>9556</b>	6 x 3/4"	100
<b>9557</b>	6 x 1"	100
<b>9564</b>	8 x 3/4"	100
<b>9565</b>	8 x 1"	100
<b>9566</b>	8 x 1-1/4"	100
<b>9568</b>	8 x 1-3/4"	100
<b>9569</b>	10 x 3/4"	100
<b>9570</b>	10 x 1"	100
<b>9571</b>	10 x 1-1/4"	100
<b>9572</b>	10 x 1-1/2"	100
<b>9575</b>	12 x 1"	100
<b>9576</b>	12 x 1-1/4"	100
<b>9577</b>	12 x 1-1/2"	100
<b>9578</b>	12 x 2"	100
<b>9581</b>	14 x 1-1/2"	100
<b>9582</b>	14 x 2"	100

**Sec. 1**

**CONSTRUCTION  
SCREWS**



**For Metal Buildings  
Metal Sheeting Fasteners  
With Neo Bond® Washer**

304 Stainless Steel

Auveco Part No.	Size	Unit Pkg.
11204	14 x 1"	25



**Fastener For Sheet Metal To Structure  
Tek® With Neo Bond® Washers  
For Overlap  
Structural Application**

Steel Zinc Plated  
Use Magnetic Chuck

Auveco Part No.	Size	Washer O.D.	Unit Pkg.
11205	#2 Tek® 12-14 x 1"	5/8"	50
11206	#3 Tek® 1/4-14 x 3/4"	5/8"	50
11207	#3 Tek® 1/4-14 x 1"	5/8"	50

Do You Want Your Customers To  
Know You Use The Best Body  
Hardware & Specialty Fasteners  
Available?  
Promotional Products And Apparel  
Bearing The  Logo Promote Your  
Identity As A Professional.

**MACHINE SCREWS**

Listed According To Size



**Phillips Oval Head Machine Screws**

Size	Chrome Part No.	Zinc Part No.	Unit Pkg.
6-32 x 3/8"		16362	100
6-32 x 1/2"		16363	100
6-32 x 3/4"		16364	100
6-32 x 1-1/4"		16365	100
8-32 x 1/2"	2299	16368	100
8-32 x 3/4"		16369	100
8-32 x 3/4" 6 Hd.	1863		100
8-32 x 1"		16370	100
8-32 x 1-1/4"		16371	100
8-32 x 1-1/2"		16372	50
10-24 x 1/2"		1877	100
10-24 x 3/4"	1934	16375	100
10-24 x 1"		16376	100
10-24 x 1-1/4"		16377	100
10-24 x 1-1/2"		16378	100
10-32 x 3/8"		16379	100
10-32 x 1/2"		16380	100
10-32 x 3/4"		16381	100
10-32 x 1" 8 Hd.	1413		100
10-32 x 1"		16382	100
10-32 x 1-1/4"		16383	50
10-32 x 1-1/2"		16384	50
12-24 x 1/2"	16528		50
12-24 x 1"	16530		50
1/4-20 x 1/2"		16385	50
1/4-20 x 3/4"		16386	50
1/4-20 x 1"		16387	50
1/4-20 x 1-1/4"		16388	50
1/4-20 x 1-1/2"		16389	50



**Slotted Oval Head Machine Screws**

Zinc Plated

Auveco Part No.	Size	Unit Pkg.
2354	10-24 x 1-1/2"	100

# MACHINE SCREWS

Listed According To Size



## Phillips Pan Head Machine Screws

Zinc Plated

Auveco Part No.	Size	Unit Pkg.
15374	6-32 x 3/8"	100
15375	6-32 x 1/2"	100
15376	6-32 x 3/4"	100
15377	6-32 x 1"	100
15378	6-32 x 1-1/4"	100
15379	6-32 x 1-1/2"	100
15380	8-32 x 3/8"	100
15381	8-32 x 1/2"	100
15382	8-32 x 3/4"	100
15383	8-32 x 1"	100
15385	8-32 x 1-1/2"	100
15386	10-24 x 3/8"	100
15387	10-24 x 1/2"	100
15388	10-24 x 3/4"	100
15389	10-24 x 1"	100
15390	10-24 x 1-1/4"	100
15391	10-24 x 1-1/2"	50
15392	10-32 x 3/8"	100
15393	10-32 x 1/2"	100
15394	10-32 x 3/4"	100
15395	10-32 x 1"	100
15396	10-32 x 1-1/4"	100
15397	10-32 x 1-1/2"	50
15398	1/4-20 x 1/2"	100
15399	1/4-20 x 3/4"	100
15400	1/4-20 x 1"	50
15401	1/4-20 x 1-1/4"	50
15402	1/4-20 x 1-1/2"	50
15403	1/4-20 x 1-3/4"	50
15404	1/4-20 x 2"	50



## Slotted Round Head Machine Screws

Bright Zinc Chromate

Auveco Part No.	Size	Unit Pkg.
5700	6-32 x 3/8"	100
2530	6-32 x 1/2"	100
2531	6-32 x 3/4"	100
2532	6-32 x 1"	100
8588	6-32 x 1-1/2"	100
5702	8-32 x 3/8"	100
2533	8-32 x 1/2"	100
2534	8-32 x 3/4"	100
2535	8-32 x 1"	100
8589	8-32 x 1-1/2"	100
8590	10-32 x 3/8"	100
2536	10-32 x 1/2"	100
2537	10-32 x 3/4"	100
2538	10-32 x 1"	100
2539	10-32 x 1-1/4"	100
2540	10-32 x 1-1/2"	100
2541	10-24 x 1/2"	100
2542	10-24 x 3/4"	100
2543	10-24 x 1"	100
2544	10-24 x 1-1/4"	100
2545	10-24 x 1-1/2"	100
8594	10-24 x 2"	100
2546	12-24 x 1/2"	100
5704	12-24 x 3/4"	100
2548	12-24 x 1"	100
2550	12-24 x 1-1/2"	100
8029	1/4-20 x 1/2"	100
8030	1/4-20 x 3/4"	100
8031	1/4-20 x 1"	100
8033	1/4-20 x 1-1/2"	100
8035	1/4-20 x 2"	100
8036	1/4-20 x 2-1/2"	100



## Phillips Round Head Machine Screws

Zinc Plated

Auveco Part No.	Size	Unit Pkg.
16407	6-32 x 1/2"	100
16408	6-32 x 3/4"	100
16411	8-32 x 1"	100
16412	10-32 x 1/2"	100
16413	10-32 x 3/4"	100
16416	10-24 x 3/4"	100

For assortments of Slotted Round Head Machine Screws refer to Fix Kits 6011 and 6503 in the green pages.

**You Can E-Mail your New Item Suggestions To**  
**mail@auveco.com**

## Sec. 2

## MACHINE SCREWS

Listed According To Size



### Slotted Round Head Machine Screws Plain Brass

Auveco Part No.	Size	Unit Pkg.
3844	8-32 x 1/2"	100
3853	10-24 x 7/8"	100
3854	10-24 x 1"	100
3859	10-32 x 5/8"	100



### Round Head Stove Bolts - Hex Nuts

Bright Zinc Chromate  
U.S.S. Coarse Thread

Auveco Part No.	Size	Unit Pkg.
5697	1/8 x 1"	100
3711	3/16 x 1/2"	100
3712	3/16 x 3/4"	100
3713	3/16 x 1"	100
3715	3/16 x 1-1/2"	100
3716	3/16 x 1-3/4"	100
3717	3/16 x 2"	100
3718	1/4 x 1/2"	100
3719	1/4 x 3/4"	100
3720	1/4 x 1"	100
3722	1/4 x 1-1/2"	100
3724	1/4 x 2"	100

**Remember...**

**All Items Are Available In Bulk.**

**Call For A Quote.**

## MISCELLANEOUS SCREWS

Listed According To Size

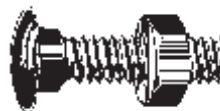

### Carriage Bolts With Hex Nuts U.S.S. Coarse Thread • Zinc Plated • Grade 2

Auveco Part No.	Size	Unit Pkg.
9482	1/4 x 1"	50
9483	1/4 x 1-1/2"	50
9484	1/4 x 2"	50
9485	1/4 x 2-1/2"	50
9486	1/4 x 3"	50
9487	1/4 x 4"	25
9489	1/4 x 6"	25
9490	5/16 x 1"	50
9491	5/16 x 1-1/2"	50
9492	5/16 x 2"	25
9493	5/16 x 3"	25
9494	5/16 x 4"	25
9498	3/8 x 1"	25
9499	3/8 x 1-1/2"	25
9500	3/8 x 2"	25
9501	3/8 x 3"	25
9502	3/8 x 4"	25
9503	3/8 x 5"	25
9507	1/2 x 2"	10
9509	1/2 x 4"	10
9510	1/2 x 6"	10



### Hex Washer Head Spin Lock Bolts

Parkerized • Grade 2

Auveco Part No.	Size	Hex	Washer Head O.D.	Unit Pkg.
2753*	1/4-20 x 5/8"	3/8"	5/8"	100
3615	5/16-18 x 3/4"	1/2"	13/16"	100
5711	5/16-18 x 1"	1/2"	13/16"	50
5713	5/16-18 x 1-1/4"	1/2"	13/16"	50
2688	5/16-24 x 1"	1/2"	13/16"	50
10296*	3/8-16 x 1"	9/16"	3/4"	50

\*Not Dog Point

## Socket Head Set Screws Cup Point



Auveco Part No.	Size	Unit Pkg.	Use Tool No.
5365	6-32 x 3/16"	50	5414
5366	6-32 x 1/4"	50	5414
5367	6-32 x 5/16"	50	5414
5368	6-32 x 3/8"	50	5414
5369	8-32 x 3/16"	50	5415
5370	8-32 x 1/4"	50	5415
5371	8-32 x 5/16"	50	5415
5372	8-32 x 3/8"	50	5415
5373	8-32 x 1/2"	50	5415

Part No. USS	Part No. SAE	Size	Unit Pkg.	Use Tool No.
--------------	--------------	------	-----------	--------------

### #10

U.S.S. (Coarse) Threads Per Inch: 24  
S.A.E. (Fine) Threads Per Inch: 32

5374	5394	10 x 3/16"	50	
5375	5395	10 x 1/4"	50	
5376	5396	10 x 5/16"	50	
5377	5397	10 x 3/8"	50	
5378	5398	10 x 1/2"	50	

### 1/4"

U.S.S. (Coarse) Threads Per Inch: 20  
S.A.E. (Fine) Threads Per Inch: 28

5379	5399	1/4 x 1/4"	50	5417
5380	5400	1/4 x 5/16"	50	5417
5381	5401	1/4 x 3/8"	50	5417
5382	5402	1/4 x 7/16"	50	5417
5383	5403	1/4 x 1/2"	50	5417

### 5/16"

U.S.S. (Coarse) Threads Per Inch: 18  
S.A.E. (Fine) Threads Per Inch: 24

5384	5404	5/16 x 1/4"	50	5418
5385	5405	5/16 x 5/16"	50	5418
5386	5406	5/16 x 3/8"	50	5418
5387	5407	5/16 x 7/16"	50	5418
5388	5408	5/16 x 1/2"	50	5418

Part No. USS	Part No. SAE	Size	Unit Pkg.	Use Tool No.
--------------	--------------	------	-----------	--------------

### 3/8"

U.S.S. (Coarse) Threads Per Inch: 16  
S.A.E. (Fine) Threads Per Inch: 24

5389	5409	3/8 x 5/16"	25	7978*
5390	5410	3/8 x 3/8"	25	7978*
5391	5411	3/8 x 7/16"	25	7978*
5392	5412	3/8 x 1/2"	25	7978*
5393	5413	3/8 x 5/8"	25	7978*

### 7/16"

U.S.S. (Coarse) Threads Per Inch: 14  
S.A.E. (Fine) Threads Per Inch: 20

15898	15905	7/16 x 3/8"	25	7978*
-------	-------	-------------	----	-------

### 1/2"

U.S.S. (Coarse) Threads Per Inch: 13  
S.A.E. (Fine) Threads Per Inch: 20

15901	15907	1/2 x 3/8"	25	7978*
15902		1/2 x 7/16"	25	7978*
15903	15909	1/2 x 1/2"	25	7978*
15904	15910	1/2 x 5/8"	25	7978*

\*Fold-up Key Set

Note: All Socket Wrenches Packed 10 per Unit Package except Key Set 7978 Unit Package: 1

For an assortment of Socket Head Set Screws, see Fix-Kit No. 6073 in the green pages.

# Sec. 2

## HEX FLANGE PRODUCT FOR FRAME BOLTING GRADE 8 HEX FLANGE PRODUCT FOR FRAME BOLTING

All Items Phosphate & Oil

Auveco flange bolts and locknuts form a strong and dependable fastening system that substantially cuts truck assembly, maintenance and repair costs. The flange bolts are made of IFI 111 industry standard specifications, and when used in conjunction with the flange locknuts form a 150,000 P.S.I. tensile strength fastening system equivalent to SAE J429, Grade 8 industry standard specification. Flat washers and lock washers are not needed with the flange bolts. Also our flange fastening system reduces the need for costly hole preparations such as deburring and countersinking.

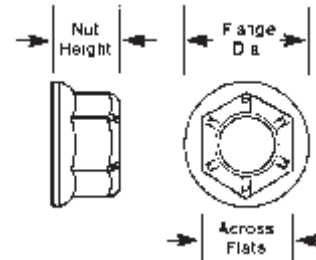
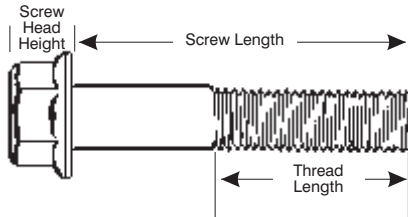

### Product Specifications

Product Diameter	Flange & Nut Diameter	Screw & Nut Across Flats	Screw Head Height	Nut Height	Minimum Screw Thread Length
3/8"	.780"/.810"	.551"/.562"	.370"/.390"	.415"/.425"	1"
1/2"	1.031"/1.070"	.736"/.750"	.490"/.510"	.545"/.555"	1-1/4"
5/8"	1.300"/1.330"	.922"/.937"	.600"/.620"	.680"/.690"	1-1/2"
3/4"	1.510"/1.565"	1.110"/1.125"	.710"/.730"	.740"/.750"	1-3/4"

### Grade 8 Hex Flange Bolts

Size	Auveco Part No. U.S.S.	U.S.S. Unit Pkg.	Auveco Part No. S.A.E.	S.A.E. Unit Pkg.	Size	Auveco Part No. U.S.S.	U.S.S. Unit Pkg.	Auveco Part No. S.A.E.	S.A.E. Unit Pkg.
<b>3/8"</b>	U.S.S. Coarse Threads Per Inch: 16				<b>5/8"</b>	S.A.E. (Fine) Threads Per Inch: 18 U.S.S. (Coarse) Threads Per Inch: 11			
3/8" x 1"	17561*	25	.....	...	5/8 x 1-1/2"	17576*	10	14493*	10
3/8" x 1-1/4"	17562	25	.....	...	5/8 x 1-3/4"	17577*	10	14494*	10
3/8" x 1-1/2"	17563	25	.....	...	5/8 x 2"	17578	10	14495*	10
3/8" x 1-3/4"	17564	25	.....	...	5/8 x 2-1/4"	17579	10	14496*	10
					5/8 x 2-1/2"	17580	10	14497	10
<b>1/2"</b>	S.A.E. (Fine) Threads Per Inch: 20 U.S.S. (Coarse) Threads Per Inch: 13				5/8 x 2-3/4"	.....	.....	14498	10
1/2 x 1"	17565*	25	14487*	10	5/8 x 3"	17582	10	14499	10
1/2 x 1-1/4"	17566*	25	.....	...	5/8 x 3-1/4"	17583	10	.....	...
1/2 x 1-1/2"	17567*	25	14489*	10	5/8 x 3-1/2"	17584	10	.....	...
1/2 x 1-3/4"	17568	25	14490*	10					
1/2 x 2"	17569	15	14491*	10					
1/2 x 2-1/4"	17570	15	.....	...					
1/2 x 2-1/2"	17571	15	.....	...					
1/2 x 3"	17573	15	.....	...					
1/2 x 3-1/4"	17574	15	.....	...					
1/2 x 3-1/2"	17575	15	.....	...					

\*Items Threaded To The Head

### Hex Flange Locknuts

Part Number	Size	Unit Pkg.	Part Number	Size	Unit Pkg.
12517	3/8-16 (Coarse)	50	12519	5/8-11 (Coarse)	25
12518	1/2"-13 (Coarse)	25	14501	5/8-18 (Fine)	25
14500	1/2-20 (Fine)	25	15180	3/4-10 (Coarse)	10

**CAP SCREWS**

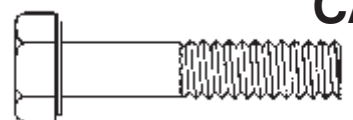

**Grade 5**

**Bright Zinc Chromate  
Medium Carbon Heat Treated Steel  
120,000 P.S.I. Minimum Tensile Strength  
Head is Identified With 3 Radial Lines**

Size	Part No. USS	Part No. SAE	Unit Pkg.
<b>1/4"</b>	U.S.S. (Coarse) Threads Per Inch: 20 S.A.E. (Fine) Threads Per Inch: 28		
1/4 x 1/2"	*5434	*5495	100
1/4 x 5/8"	*5435		100
1/4 x 3/4"	*5436	*5497	100
1/4 x 1"	5438	5499	100
1/4 x 1-1/4"	5439	5500	100
1/4 x 1-1/2"	5440	5501	100
1/4 x 1-3/4"	5441		100
1/4 x 2"	5442		100
1/4 x 2-1/4"	5443		100
1/4 x 2-1/2"	5444	5505	100
1/4 x 2-3/4"	5445		100
1/4 x 3"	5446		100
1/4 x 3-1/2"	8449		100
<b>5/16"</b>	U.S.S. (Coarse) Threads Per Inch: 18 S.A.E. (Fine) Threads Per Inch: 24		
5/16 x 1/2"	*5447		100
5/16 x 5/8"	*5448		100
5/16 x 3/4"	*5449	*5510	100
5/16 x 7/8"	*5450		100
5/16 x 1"	5451	5512	100
5/16 x 1-1/4"	5452	5513	100
5/16 x 1-1/2"	5453	5514	100
5/16 x 1-3/4"	5454		100
5/16 x 2"	5455	5516	50
5/16 x 2-1/4"	5456		50
5/16 x 2-1/2"	5457		50
5/16 x 3"	5459		50
5/16 x 3-1/2"	5461		50
5/16 x 4"	8450		50
<b>3/8"</b>	U.S.S. (Coarse) Threads Per Inch: 16 S.A.E. (Fine) Threads Per Inch: 24		
3/8 x 5/8"	*5462		50
3/8 x 3/4"	*5463	*5524	50
3/8 x 7/8"	*5464		50
3/8 x 1"	*5465	*5526	50
3/8 x 1-1/4"	5466	*5527	50
3/8 x 1-1/2"	5467	5528	50
3/8 x 1-3/4"	5468		50
3/8 x 2"	5469	5530	50
3/8 x 2-1/4"	5470		50
3/8 x 2-1/2"	5471		50
3/8 x 3"	5472	5533	50
3/8 x 3-1/2"	5473		50
3/8 x 4"	5474		50
3/8 x 4-1/2"	8096		25
3/8 x 5"	8097		25

\*Items Threaded To Head

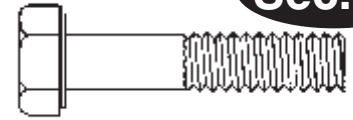

**Grade 5**

**Bright Zinc Chromate  
Medium Carbon Heat Treated Steel  
120,000 P.S.I. Minimum Tensile Strength  
Head is Identified With 3 Radial Lines**

Size	Part No. USS	Part No. SAE	Unit Pkg.
<b>7/16"</b>	U.S.S. (Coarse) Threads Per Inch: 14 S.A.E. (Fine) Threads Per Inch: 20		
7/16 x 3/4"	*5475		50
7/16 x 1"	*5476	*5537	50
7/16 x 1-1/4"	5477	5538	50
7/16 x 1-1/2"	5478	5539	50
7/16 x 1-3/4"	5479		50
7/16 x 2"	5480		25
7/16 x 2-1/2"	5481	5542	25
7/16 x 3"	5482		25
7/16 x 3-1/2"	5483	5544	25
7/16 x 4"	5484		25
<b>1/2"</b>	U.S.S. (Coarse) Threads Per Inch: 13 S.A.E. (Fine) Threads Per Inch: 20		
1/2 x 3/4"	*5485		50
1/2 x 1"	*5486	*5547	50
1/2 x 1-1/4"	*5487		50
1/2 x 1-1/2"	5488		25
1/2 x 1-3/4"	5489	5550	25
1/2 x 2"	5490	5551	25
1/2 x 2-1/2"	5491	5552	25
1/2 x 3"	5492	5553	25
1/2 x 3-1/2"	5493		25
1/2 x 4"	5494		25
1/2 x 4-1/2"	8104		25
1/2 x 5"	8105		25
1/2 x 6"	8107		25
<b>5/8"</b>	U.S.S. (Coarse) Threads Per Inch: 11 S.A.E. (Fine) Threads Per Inch: 18		
5/8 x 1"	*9520		25
5/8 x 1-1/2"	*9521	*9528	25
5/8 x 2"	9522	9529	25
5/8 x 2-1/2"	9523		25
5/8 x 3"	9524		25
5/8 x 3-1/2"	9525		25
5/8 x 4"	9526		25
<b>3/4"</b>	U.S.S. (Coarse) Threads Per Inch: 10		
3/4 x 2"	8453		10
3/4 x 2-1/2"	8454		10
3/4 x 3"	8455		10
3/4 x 3-1/2"	8456		10
3/4 x 5"	8459		10

\*Items Threaded To Head

Refer to Assortment 1020 in the green pages

**Sec. 2**

**CAP SCREWS**

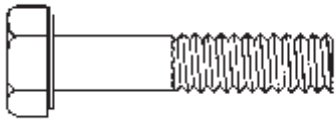

**Grade 8**

**Zinc & Yellow Dichromate  
Medium Carbon Alloy Steel**

**150,000 P.S.I. Minimum Tensile Strength  
Head Is Identified With 6 Radial Lines**

Size	Part No. USS	Part No. SAE	Unit Pkg.
<b>1/4"</b>	U.S.S. (Coarse) Threads Per Inch: 20 S.A.E. (Fine) Threads Per Inch: 28		
1/4 x 1/2"	*9118		50
1/4 x 3/4"	*9119	*9174	50
1/4 x 1"	9120		50
1/4 x 1-1/4"	9121		50
1/4 x 1-1/2"	9122	9177	50
1/4 x 2"	9124		50
1/4 x 2-1/4"	9125		25
1/4 x 2-1/2"	9126		25

<b>5/16"</b>	U.S.S. (Coarse) Threads Per Inch: 18 S.A.E. (Fine) Threads Per Inch: 24		
5/16 x 1/2"	*9127		50
5/16 x 3/4"	*9128		50
5/16 x 1"	9129	9184	50
5/16 x 1-1/4"	9130		50
5/16 x 1-1/2"	9131	9186	50
5/16 x 1-3/4"	9132		50
5/16 x 2"	9133	9188	50
5/16 x 2-1/2"	9134		25
5/16 x 3"	9135		25
5/16 x 5"	17030		10

<b>3/8"</b>	U.S.S. (Coarse) Threads Per Inch: 16 S.A.E. (Fine) Threads Per Inch: 24		
3/8 x 3/4"	*9136	*9191	50
3/8 x 1"	*9137	*9192	50
3/8 x 1-1/4"	9138	9193	50
3/8 x 1-1/2"	9139	9194	50
3/8 x 2"	9140		25
3/8 x 2-1/2"	9141		25
3/8 x 3"	9142		25
3/8 x 3-1/2"	17028		15
3/8 x 4"	9143	9198	25

\*Items Threaded To Head

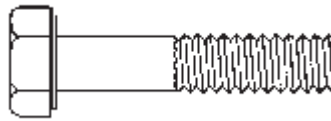

**Grade 8**

**Zinc & Yellow Dichromate  
Medium Carbon Alloy Steel**

**150,000 P.S.I. Minimum Tensile Strength  
Head Is Identified With 6 Radial Lines**

Size	Part No. USS	Part No. SAE	Unit Pkg.
<b>7/16"</b>	U.S.S. (Coarse) Threads Per Inch: 14 S.A.E. (Fine) Threads Per Inch: 20		
7/16 x 1"	*9144	*9199	25
7/16 x 1-1/4"	9145		25
7/16 x 1-1/2"	9146	9201	25
7/16 x 2"	9147		25
7/16 x 2-1/2"	9148	9203	25
7/16 x 3"	9149		25
7/16 x 4"	9150		25
7/16 x 5-1/2"	17031		10
<b>1/2"</b>	U.S.S. (Coarse) Threads Per Inch: 13 S.A.E. (Fine) Threads Per Inch: 20		
1/2 x 1"	*9151		25
1/2 x 1-1/4"	*9152		25
1/2 x 1-1/2"	9153	9208	25
1/2 x 1-3/4"	9154	9209	25
1/2 x 2"	9155	9210	25
1/2 x 2-1/2"	9156		25
1/2 x 2-3/4"		17983	10
1/2 x 3"	9157	9212	10
1/2 x 4"	9158	9213	10
1/2 x 5"	9159		10
<b>5/8"</b>	U.S.S. (Coarse) Threads Per Inch: 11 S.A.E. (Fine) Threads Per Inch: 18		
5/8 x 1-1/2"	*9160	*9215	10
5/8 x 2"	9161		10
5/8 x 2-1/2"	9162		10
5/8 x 3"	9163		10
5/8 x 3-1/2"	17499		10
5/8 x 4"	9164	9219	10
5/8 x 5"	9165		10
<b>3/4"</b>	U.S.S. (Coarse) Threads Per Inch: 10 S.A.E. (Fine) Threads Per Inch: 16		
3/4 x 2"	9167		10
3/4 x 2-1/2"	9168	9223	10
3/4 x 3"	9169	9224	10
3/4 x 3-1/2"	9170		10
3/4 x 4"	9171		10
3/4 x 5"	9172		10

\* Items Threaded to Head

Refer to Assortment 1030 in the green pages



# STAINLESS STEEL

# Sec. 2

18-8 (300 SERIES)



## Stainless Steel Phillips Pan Head Tapping Screws

## Stainless Steel Phillips Oval Head Tapping Screws

Auveco Part No.	Size	Unit Pkg.
13265	6 x 1/2"	100
13266	6 x 3/4"	100
13267	6 x 1"	100
13268	6 x 1-1/4"	100
13269	8 x 1/2"	100
13270	8 x 3/4"	50
13271	8 x 1"	50
13272	8 x 1-1/4"	50
13273	8 x 1-1/2"	25
13274	10 x 1/2"	100
13275	10 x 3/4"	50
13276	10 x 1"	50
13277	10 x 1-1/4"	50
13278	10 x 1-1/2"	25
13279	10 x 1-3/4"	25
13280	12 x 1/2"	50
13281	12 x 3/4"	50
13282	12 x 1"	50
13283	12 x 1-1/4"	25
13284	12 x 1-1/2"	25

Auveco Part No.	Size	Unit Pkg.
9399	6 x 1/2"	100
9400	6 x 3/4"	100
9401	6 x 1"	100
9402	6 x 1-1/4"	100
9403	8 x 1/2"	100
9404	8 x 3/4"	100
9405	8 x 1"	100
9406	8 x 1-1/4"	100
9407	8 x 1-1/2"	100
9408	10 x 1/2"	100
9409	10 x 3/4"	100
9410	10 x 1"	100
9411	10 x 1-1/4"	100
9412	10 x 1-1/2"	100
13286	10 x 1-3/4"	25
13288	12 x 3/4"	50
13289	12 x 1"	50
13290	12 x 1-1/4"	25
13291	12 x 1-1/2"	25
13292	12 x 1-3/4"	25



## Stainless Steel Slotted Round Head Machine Screws



## Stainless Steel Phillips Oval Head Machine Screws

Auveco Part No.	Size	Unit Pkg.
13293	6-32 x 1/4"	100
13294	6-32 x 1/2"	100
13295	6-32 x 3/4"	100
13296	6-32 x 1"	100
13298	8-32 x 1/4"	100
13299	8-32 x 1/2"	100
13300	8-32 x 3/4"	100
13301	8-32 x 1"	100
13302	8-32 x 1-1/4"	50
13304	10-24 x 1/2"	100
13305	10-24 x 3/4"	100
13306	10-24 x 1"	50
13308	10-24 x 1-1/2"	50
13310	10-32 x 1/2"	100
13311	10-32 x 3/4"	100
13312	10-32 x 1"	50
13314	10-32 x 1-1/2"	50
13316	1/4-20 x 3/4"	50
13317	1/4-20 x 1"	25
13318	1/4-20 x 1-1/4"	25
13319	1/4-20 x 1-1/2"	25
13320	1/4-20 x 1-3/4"	25

Auveco Part No.	Size	Unit Pkg.
13322	6-32 x 1/2"	100
13323	6-32 x 3/4"	100
13324	6-32 x 1"	100
13325	6-32 x 1-1/4"	100
13326	8-32 x 1/4"	100
13327	8-32 x 1/2"	100
13328	8-32 x 3/4"	100
13329	8-32 x 1"	100
13330	8-32 x 1-1/4"	50
13331	10-24 x 1/2"	100
13332	10-24 x 3/4"	50
13333	10-24 x 1"	50
13334	10-24 x 1-1/4"	50
13335	10-24 x 1-1/2"	50
13336	10-32 x 1/2"	100
13337	10-32 x 3/4"	50
13338	10-32 x 1"	50
13339	10-32 x 1-1/4"	50
13340	10-32 x 1-1/2"	50
13341	1/4-20 x 1/2"	50
13342	1/4-20 x 3/4"	50
13343	1/4-20 x 1"	25
13344	1/4-20 x 1-1/4"	25
13345	1/4-20 x 1-1/2"	25

**STAINLESS STEEL**

18-8 (300 SERIES)



**U.S.S. Coarse Thread  
Stainless Steel Hex Head Cap Screws**

Auveco Part No.	Bolt Size	Unit Pkg.	Auveco Part No.	Bolt Size	Unit Pkg.
* 13346	1/4-20 x 1/2"	50	13369	3/8-16 x 2-1/4"	25
* 13347	1/4-20 x 3/4"	50	13370	3/8-16 x 2-1/2"	25
13348	1/4-20 x 1"	50	13391	3/8-16 x 3"	25
13349	1/4-20 x 1-1/4"	50	* 13373	1/2-13 x 1"	10
13350	1/4-20 x 1-1/2"	50	* 13374	1/2-13 x 1-1/4"	10
13351	1/4-20 x 1-3/4"	25	13375	1/2-13 x 1-1/2"	10
13352	1/4-20 x 2"	25	13377	1/2-13 x 2"	10
* 13353	5/16-18 x 1/2"	50	13379	1/2-13 x 2-1/2"	10
* 13354	5/16-18 x 3/4"	25			
13355	5/16-18 x 1"	25	13385	5/8-11 x 1-3/4"	10
13356	5/16-18 x 1-1/4"	25	13386	5/8-11 x 2"	10
13357	5/16-18 x 1-1/2"	25	13388	5/8-11 x 2-1/2"	10
13358	5/16-18 x 1-3/4"	25	13390	5/8-11 x 3"	5
13359	5/16-18 x 2"	25			
13360	5/16-18 x 2-1/4"	25			
13361	5/16-18 x 2-1/2"	25			
* 13362	3/8-16 x 1/2"	50			
* 13363	3/8-16 x 3/4"	50			
* 13364	3/8-16 x 1"	50			
13365	3/8-16 x 1-1/4"	25			
13366	3/8-16 x 1-1/2"	25			
13367	3/8-16 x 1-3/4"	25			
13368	3/8-16 x 2"	25			

\* Items Threaded To Head



**Stainless Steel Cotter Pins**  
Extended Prong Type

Auveco Part No.	Size	Rec. Hole Size	Unit Pkg.	Auveco Part No.	Size	Rec. Hole Size	Unit Pkg.
13408	1/16 x 1/2"	.078	100	13422	1/8 x 1-1/2"	.141	50
13409	1/16 x 3/4"	.078	100	13423	1/8 x 1-3/4"	.141	25
13410	1/16 x 1"	.078	100	13424	1/8 x 2"	.141	25
				13425	1/8 x 2-1/4"	.141	25
13411	3/32 x 1/2"	.109	100	13426	1/8 x 2-1/2"	.141	25
13412	3/32 x 3/4"	.109	100				
13413	3/32 x 1"	.109	100	13428	5/32 x 1"	.172	50
13414	3/32 x 1-1/4"	.109	50	13429	5/32 x 1-1/4"	.172	50
13415	3/32 x 1-1/2"	.109	50	13430	5/32 x 1-1/2"	.172	25
13416	3/32 x 1-3/4"	.109	50	13431	5/32 x 1-3/4"	.172	25
13417	3/32 x 2"	.109	50	13432	5/32 x 2"	.172	25
				13434	5/32 x 2-1/2"	.172	25
13419	1/8 x 3/4"	.141	100				
13420	1/8 x 1"	.141	50				
13421	1/8 x 1-1/4"	.141	50				

# STAINLESS STEEL

## Sec. 2

18-8 (300 SERIES)

### Stainless Steel Wing Nuts

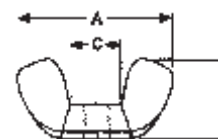

Auveco Part No.	Size	Wing Spread (A)		Overall Height (B)		Between Wing (C)		Unit Pkg.
		Max.	Min.	Max.	Min.	Max.	Min.	
13255	8-32	.91	.78	.47	.34	.27	.22	25
13256	10-24	.91	.78	.47	.34	.27	.22	25
13258	1/4-20	1.10	.97	.57	.43	.39	.26	25
13259	5/16-18	1.25	1.12	.66	.53	.39	.32	10



### Stainless Steel Hex Machine Screw Nuts

Auveco Part No.	Size	Hex Width	Unit Pkg.
13260	6-32	5/16"	100
13261	8-32	11/32"	100
13262	10-24	3/8"	100
13263	10-32	3/8"	100
13264	1/4-20	7/16"	100

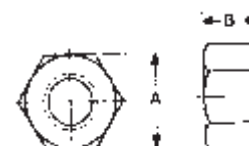

### Stainless Steel Hex Nuts

Auveco Part No.	Size	Hex Width (A)	Thickness (B)	Unit Pkg.
13234	1/4-20	7/16"	7/32"	100
13235	5/16-18	1/2"	17/64"	50
13236	3/8-16	9/16"	21/64"	50
13237	1/2-13	3/4"	7/16"	25



### Stainless Steel Acorn Nuts

Auveco Part No.	Size	Hex Width	Unit Pkg.
13248	6-32	5/16"	25
13249	8-32	5/16"	25
13250	10-24	3/8"	25
13251	10-32	3/8"	25
13252	1/4-20	7/16"	25
13253	5/16-18	9/16"	10



### Stainless Steel Nylon Insert Lock Nuts

Auveco Part No.	Size	Hex Width	Unit Pkg.
13239	6-32	5/16"	50
13240	8-32	11/32"	50
13241	10-24	3/8"	50
13242	10-32	3/8"	50
13243	1/4-20	7/16"	50
13244	5/16-18	1/2"	25
13245	3/8-16	9/16"	25
13246	1/2-13	3/4"	10

**STAINLESS STEEL**  
18-8 (300 SERIES)

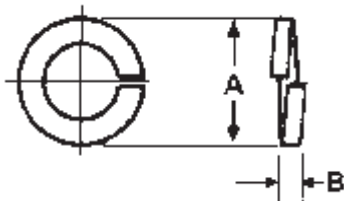

**Stainless Steel Medium Split Washers**

Auveco Part No.	Size	O.D. (A)	Minimum Thickness (B)	Unit Pkg.
13400	No. 6 or 1/8"	1/4"	.031	100
13401	No. 8	19/64"	.040	100
13402	No. 10 or 3/16"	21/64"	.047	100
13403	1/4"	31/64"	.062	100
13404	5/16"	19/32"	.078	100
13405	3/8"	11/16"	.094	100
13406	1/2"	7/8"	.125	50

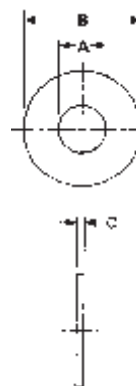

**Stainless Steel Commercial Flat Washers**

Auveco Part No.	Bolt Size	I.D. (A)	O.D. (B)	Approximate Thickness (C)	Unit Pkg.
13392	No. 6 or 1/8"	9/64"	3/8"	.030	100
13393	No. 8	5/32"	3/8"	.030	100
13394	No. 10 or 3/16"	7/32"	7/16"	.030	100
13395	1/4"	9/32"	5/8"	.043	100
13396	5/16"	11/32"	3/4"	.050	100
13397	3/8"	13/32"	7/8"	.060	50
13398	1/2"	33/64"	1-1/4"	.060	50
13399	5/8"	11/16"	1-1/2"	.075	25

# BUMPER BOLTS

Listed According To Size

Zinc Plated

**Sec. 3**

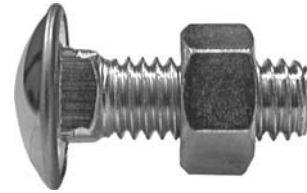
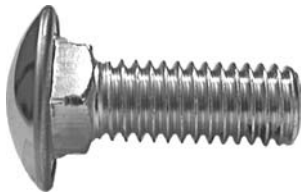

Auveco Part No.	Size	Head Style	Head Diameter	Unit Pkg.
<b>Round Polished Stainless Steel Capped Heads</b>				
5714*	5/16-18x 7/8"	Round	11/16"	Without Nuts .....25
5238	3/8-16x 7/8"	Round	27/32"	Without Nuts .....25
3414	3/8-16x 7/8"	Round	27/32"	With Hex Nuts .....25
3432	3/8-16x 7/8"	Round	27/32"	With Lock Nuts.....25
5239	3/8-16x 1"	Round	27/32"	Without Nuts .....25
3415	3/8-16x 1"	Round	27/32"	With Hex Nuts .....25
3433	3/8-16x 1"	Round	27/32"	With Lock Nuts.....25
5240	3/8-16x 1-1/4"	Round	27/32"	Without Nuts .....25
3820	3/8-16x 1-1/4"	Round	27/32"	With Hex Nuts .....25
3821	3/8-16x 1-1/4"	Round	27/32"	With Lock Nuts.....25
5241	3/8-16x 1-1/2"	Round	27/32"	Without Nuts .....25
3822	3/8-16x 1-1/2"	Round	27/32"	With Hex Nuts .....25
3823	3/8-16x 1-1/2"	Round	27/32"	With Lock Nuts.....25
8626	7/16-14x 7/8"	Round	31/32"	Without Nuts .....25
8627	7/16-14x 7/8"	Round	31/32"	With Hex Nuts .....25
8552	7/16-14x 1"	Round	31/32"	Without Nuts .....25
8557	7/16-14x 1"	Round	31/32"	With Hex Nuts .....25
8562	7/16-14x 1"	Round	31/32"	With Lock Nuts.....25
5242	7/16-14x 1-1/4"	Round	31/32"	Without Nuts .....25
3099	7/16-14x 1-1/4"	Round	31/32"	With Hex Nuts .....10
3434	7/16-14x 1-1/4"	Round	31/32"	With Lock Nuts.....25
5243	7/16-14x 1-1/2"	Round	31/32"	Without Nuts .....25
3100	7/16-14x 1-1/2"	Round	31/32"	With Hex Nuts .....10
3435	7/16-14x 1-1/2"	Round	31/32"	With Lock Nuts.....25
8567	1/2-13x 1-1/4"	Round	1-3/32"	Without Nuts ..... 25
8570	1/2-13x 1-1/4"	Round	1-3/32"	With Hex Nuts ..... 25
8573	1/2-13x 1-1/4"	Round	1-3/32"	With Lock Nuts..... 25
5246	1/2-13x 1-1/2"	Round	1-3/32"	Without Nuts ..... 25
3102	1/2-13x 1-1/2"	Round	1-3/32"	With Hex Nuts ..... 10
3438	1/2-13x 1-1/2"	Round	1-3/32"	With Lock Nuts..... 25

\* Not Stainless Steel Cap - Chrome Plated

**Sec. 3**

**BUMPER BOLTS**  
(ILLUSTRATIONS ACTUAL SIZE)



**15545**  
Zinc

1/4"-20 x 3/4"  
Stainless Steel Cap  
w/o Nuts  
Head Diameter: 5/8"  
Shoulder Length: 9/64"

UNIT PACKAGE: 25



**9853**  
(376337-S100)  
Zinc

5/16"-18 x 3/4"  
Stainless Steel Cap  
w/o Nuts  
Head Diameter: 3/4"  
Shoulder Length: 3/16"  
Ford

UNIT PACKAGE: 25

**9854**

Same as 9853 except with Hex Nuts

UNIT PACKAGE: 25

**9855**

Same as 9853 except with Lock Nuts

UNIT PACKAGE: 25

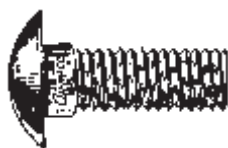

**16985**  
Zinc

5/16"-18 x 1"  
Stainless Steel Cap  
w/o Nuts  
Head Diameter: 3/4"  
Shoulder Length: 3/16"

UNIT PACKAGE: 25



**11614**  
(9433489)  
Zinc

3/8"-16 x 1"  
Stainless Steel Capped  
Pan Head  
w/o Nuts  
Head Diameter: 7/8"  
Shoulder Length: 3/32"  
GM

UNIT PACKAGE: 25

**11615**

Same as 11614 except  
with Hex Nuts

UNIT PACKAGE: 25



**10655**  
(6026723)  
Zinc

3/8"-16 x 1"  
Stainless Steel Capped  
Pan Head  
w/o Nuts  
Head Dia: 7/8"  
Shoulder Length: 3/32"  
Chrysler

UNIT PACKAGE: 25

**10656**

Same as 10655 except  
with Hex Nuts

UNIT PACKAGE: 25

**10657**

Same as 10655 except  
with Lock Nuts

UNIT PACKAGE: 25

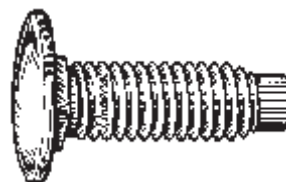

**16544**  
Zinc & Yellow

3/8"-16 x 1-1/4"  
Stainless Steel Capped  
Pan Head  
w/o Nuts  
Head Diameter: 7/8"  
Shoulder Length: 1/8"

UNIT PACKAGE: 10



**8623**  
Zinc

7/16"-14 x 1"  
Stainless Steel Capped Pan Head  
w/o Nuts  
Head Diameter: 29/32"  
Shoulder Length: 5/32"  
GM

UNIT PACKAGE: 25

**8624**

Same as 8623 except with Hex Nuts

UNIT PACKAGE: 25

**8625**

Same as 8623 except  
with Lock Nuts

UNIT PACKAGE: 25

**BUMPER BOLTS**  
(ILLUSTRATIONS ACTUAL SIZE)



**9354**  
(9786454)  
Zinc

7/16"-14 x 1-3/8"  
Stainless Steel Capped  
Pan Head  
w/o Nuts  
Head Diameter: 29/32"  
Shoulder Length: 5/32"  
GM

UNIT PACKAGE: 25

**9355**

Same as 9354 except with Hex Nuts

UNIT PACKAGE: 25

**9356**

Same as 9354 except with Lock Nuts

UNIT PACKAGE: 25

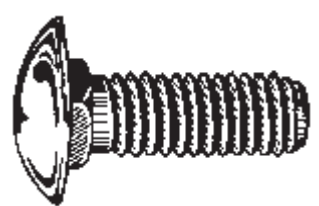

**10068**  
(9795883)  
Zinc

7/16"-14 x 1-1/4"  
Uncapped Round Head  
w/o Nuts  
Head Diameter: 15/16"  
Shoulder Length: 7/32"  
GM

UNIT PACKAGE: 25

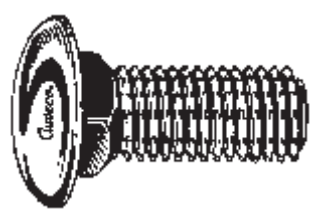

**16475**  
Zinc

7/16"-14 x 1-1/4"  
Stainless Steel Cap  
w/o Nuts  
Head Diameter: 29/32"  
Shoulder Length: 1/4"

UNIT PACKAGE: 10



**16483**  
Zinc

7/16"-14 x 1-1/2"  
Stainless Steel Cap  
w/o Nuts  
Head Diameter: 29/32"  
Shoulder Length: 1/4"

UNIT PACKAGE: 10



**11770**  
(490067)  
Zinc

7/16"-14 x 1-1/2"  
Uncapped Round Head  
w/o Nuts  
Head Diameter: 15/16"  
Shoulder Length: 3/16"  
GM

UNIT PACKAGE: 25

**11771**

Same as 11770 except  
with Hex Nuts

UNIT PACKAGE: 25



**10377**  
(23472-S8)  
Zinc

7/16"-14 x 1-1/2"  
Uncapped Round Head  
w/o Nuts  
Head Diameter: 15/16"  
Shoulder Length: 7/32"  
Ford

UNIT PACKAGE: 25



**10078**  
(6026724)  
Zinc

1/2"-13 x 1-3/8"  
Stainless Steel Capped Pan Head  
w/o Nuts  
Head Diameter: 1-7/64"  
Shoulder Length: 3/32"  
Chrysler

UNIT PACKAGE: 25

**10079**

Same as 10078 except w/ Hex Nuts

UNIT PACKAGE: 25

**10083**

Same as 10078 except w/ Lock Nuts

UNIT PACKAGE: 25



**15310**  
(11503687)  
Phosphate

M8-1.25 x 30mm  
Uncapped Round Head  
w/o Nuts  
Head Diameter: 17.5mm  
Shoulder Length: 3mm  
GM

UNIT PACKAGE: 25

**Sec. 3**

**SPECIAL CARRIAGE & BUMPER BOLTS**

(ILLUSTRATIONS ACTUAL SIZE)



**12659**

(11502479, 11502480, 12338141)  
Zinc

M8-1.25 x 20mm  
Stainless Steel Capped  
Pan Head  
w/o Nuts  
Head Diameter: 19mm  
Shoulder Length: 2mm  
GM

UNIT PACKAGE: 25

**12660**

Same as 12659 except  
with Hex Nuts

UNIT PACKAGE: 25



**16986**

(14003784)  
Zinc

M8-1.25 x 25mm  
Stainless Steel Capped  
Pan Head  
w/o Nuts  
Head Diameter: 19mm  
Shoulder Length: 3mm  
GM

UNIT PACKAGE: 25

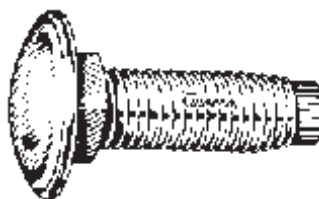

**16932**

(N802081-S100,  
AB-305L)  
Black Zinc

M10-1.5 x 33mm  
Stainless Steel Cap w/o Nuts  
Head Diameter: 23mm  
Shoulder Length: 5mm  
Ford Truck

UNIT PACKAGE: 5

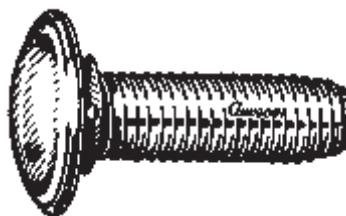

**17187**

(N800883-S100)  
Black Phosphate

M12-1.75 x 40mm  
Stainless Steel Cap w/o Nuts  
Sealing Patch On Threads  
Head Diameter: 28mm  
Shoulder Length: 5mm  
Ford Truck F 150/350  
& U150 1980-On

UNIT PACKAGE: 5

**Do You Want Your Customers To Know You Use The Best Body  
Hardware & Specialty Fasteners Available?**

**Promotional Products And Apparel Bearing The  Logo  
Promote Your Identity As A Professional.**



# BODY BOLTS

**Sec. 3**



**2209**  
Chrome

#8-32 x 5/16"  
Phillips Truss Head

UNIT PACKAGE: 100

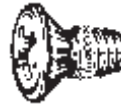

**16535**  
(6026815)  
Chrome

1/4"-20 x 1/2"  
Phillips Oval Head  
With Nylon Patch on Threads  
Rear Center Panel  
Chrysler Full Size Van

UNIT PACKAGE: 25

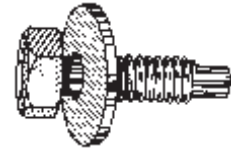

**17034**  
(57030-S36)  
Zinc & Yellow Dichromate

1/4"-20 x 7/8"  
Hex Head Sems®  
With Dog Point  
3/4" Washer O.D.  
7/16" Hex  
Ford

UNIT PACKAGE: 50

**FasTrack®**  
**Auveco's Cost Recovery System**  
**For Repair Fasteners**  
**Never Lose Money**  
**On Fasteners Again....**



**13231**  
(14007510)  
Phos. Organic

1/4"-20 x 7/8"  
Hex Washer Head  
w/ Sems® Nylon Washer  
5/8" Washer O.D.  
3/8" Hex  
Truck Mirror  
Mounting Screw  
GM

UNIT PACKAGE: 25



**16537**  
(601644)  
Phosphate

#10-32 x 5/8"  
Phillips Fillister Head  
W/ Nylon Patch On Threads  
Front Door Manual Window  
Regulator Handle  
Chrysler LeBaron & Mini-Van

UNIT PACKAGE: 50



**10823**  
Black Parkerized

1/4"-20 x 7/8"  
Hex Head Sems®  
with Dog Point  
3/4" Washer O.D.  
7/16" Hex

UNIT PACKAGE: 50



**13232**  
(14007510,  
367292)

Phos. Organic Screw  
Zinc w/Sealer Jack Nut

1/4"-20 x 7/8"  
Hex Washer Head  
w/ Sems® Nylon Washer  
5/8" Washer O.D.  
3/8" Hex  
Truck Mirror Mounting Screw  
& Jack Nut  
GM, Chrysler

UNIT PACKAGE: 25 Sets

**Sec. 3**

**BODY BOLTS**



**9480**

(6025329)  
Phosphate

1/4"-20 x 1"  
Hex Head Sems®  
with Dog Point  
5/8" Washer O.D.  
7/16" Hex  
Chrysler

UNIT PACKAGE: 50



**14976**

(367291, 474821,  
14007511)

400 Series Stainless Steel  
Bright Plated

1/4"-20 x 1-1/4"  
Hex Washer Head  
With Nylon Washer  
5/8" Washer O.D.  
3/8" Hex  
Truck Mirror Mounting  
Screw  
GM, Chrysler

UNIT PACKAGE: 25



**10084**

Black Phosphate

5/16"-18 x 3/4"  
Hex Washer Head  
21/32" Washer Head O.D.  
1/2" Hex  
GM

UNIT PACKAGE: 100

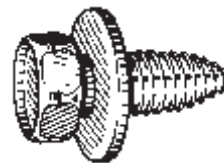

**15783**

(3846202)  
Phosphate

5/16"-18 x 7/8"  
Indented Hex Head Sems®  
3/4" Washer O.D.  
1/2" Hex  
GM

UNIT PACKAGE: 50



**9757**

Phosphate

1/4"-20 x 1"  
Hex Head Sems®  
1" Washer O.D.  
3/8" Hex  
GM, Ford

UNIT PACKAGE: 100

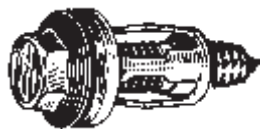

**14977**

(367291, 367292,  
474821, 14007511)  
400 Series Stainless  
Steel - Bright Plated  
Zinc w/Sealer  
Jack Nut

1/4"-20 x 1-1/4"  
Hex Washer Head  
With Nylon Washer  
5/8" Washer O.D.  
3/8" Hex  
Truck Mirror Mounting  
Screw & Jack Nut  
GM, Chrysler

UNIT PACKAGE: 10 Sets



**10362**

Black Phosphate

5/16"-18 x 13/16"  
Hex Washer Head  
41/64" Washer Head O.D.  
1/2" Hex  
GM

UNIT PACKAGE: 50

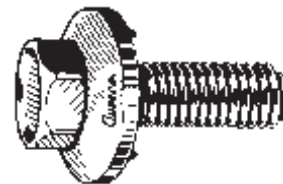

**9756**

Phosphate

5/16"-18 x 1"  
Hex Head Sems®  
7/8" Washer O.D.  
1/2" Hex  
GM, Ford

UNIT PACKAGE: 100

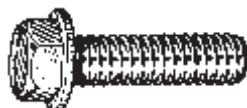

**15510**

Zinc

1/4"-20 x 1"  
Hex Washer Head  
1/2" Washer Head O.D.  
3/8" Hex

UNIT PACKAGE: 50

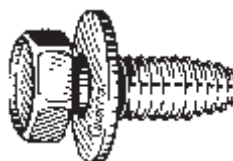

**15792**

(15598757, 15686047)  
Phosphate Organic

5/16"-18 x 7/8"  
Indented Hex Head Sems®  
3/4" Washer O.D.  
1/2" Hex  
GM

UNIT PACKAGE: 50



**11320**

Phosphate

5/16"-18 x 1"  
Hex Head Sems®  
7/8" Washer O.D.  
1/2" Hex  
GM, Ford

UNIT PACKAGE: 25

# BODY BOLTS

**Sec. 3**

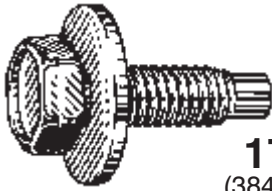

**17035**  
(384931-S36)  
Zinc & Yellow Dichromate  
5/16"-18 x 1-1/16"  
Hex Hd. Sems® with Dog Pt.  
7/8" Washer O.D.  
1/2" Hex  
Ford

UNIT PACKAGE: 25

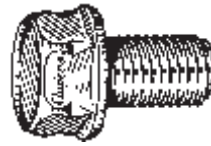

**15511**  
(9440034)  
Phosphate  
3/8"-16 x 5/8"  
Indented Hex Head Flange Bolt  
3/4" Flange O.D.  
9/16" Hex  
Transmissions  
Grade 5  
GM

UNIT PACKAGE: 50

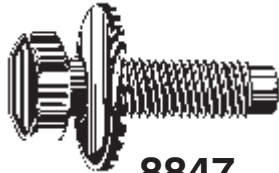

**8847**  
(380575-S2)  
Black  
Parkerized  
5/16"-18 x 1-1/4"  
Hex Head Sems® With Dog Point  
7/8" Washer O.D.  
1/2" Hex  
Ford

UNIT PACKAGE: 50



**11109**  
(3986997,  
14011722)  
Phosphate  
3/8"-16 x 1"  
Hex Head Sems®  
1" Washer O.D.  
9/16" Hex  
GM

UNIT PACKAGE: 25

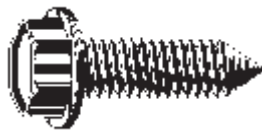

**11061**  
Plain  
5/16"-18 x 1-1/4"  
Hex Washer Head  
With Pinch Point  
21/32" Washer Head O.D.  
1/2" Hex  
Grade 5

UNIT PACKAGE: 50



**11110**  
(407217, 1564180)  
Phosphate  
3/8"-16 x 1-1/2"  
Hex Head Sems®  
1-1/8" Washer O.D.  
9/16" Hex  
Hood Hinge To Sheet Metal Bolt  
GM

UNIT PACKAGE: 25



**12009**  
Phosphate & Oil  
5/16"-18 x 1-1/2"  
Hex Washer Head  
21/32" Washer Head O.D.  
1/2" Hex  
GM

UNIT PACKAGE: 50



**16739**  
(1366042)  
Zinc  
3/8"-16 x 1-7/8"  
Hex Washer Head  
3/4" Washer Head O.D.  
9/16" Hex  
Starter Bolt  
Grade 5  
GM

UNIT PACKAGE: 5

# Sec. 4

# SPECIAL TAPPING SCREWS



**9877**

Stainless Steel

#4-24 x 3/8"  
Special Phillips Flat Head  
7/32" Head Diameter  
Use To Replace Welded  
Studs For Moulding Clips

UNIT PACKAGE: 100



**13707**

(9422246)  
Zinc

#8 x 3/8"  
Phillips Flat Top Wshr Hd  
13/32" Washer Head O.D.  
Chrysler

UNIT PACKAGE: 100



**15037**

(588546)  
Chrome

#8 x 7/16"  
Phillips Washer Head  
410 Stainless Steel  
5/16" Washer Head O.D.  
Wheel Mouldings  
GM

UNIT PACKAGE: 100



**12739**

(11501794)  
Chrome

M4.2-1.41 x 12mm  
(#8 x 15/32")  
Phillips Washer Head  
Pozi-Drive  
10mm (25/64")  
Washer Head O.D.  
GM

UNIT PACKAGE: 100



**10642**

(381671-S)  
Zinc

#8 x 3/8"  
Phillips Oval Washer Head  
3/8" Washer Head O.D.  
Wheel Opening Mouldings  
Ford

UNIT PACKAGE: 100



**8944**

Chrome

#8-18 x 3/8"  
Phillips Washer Head  
7/16" Washer Head O.D.  
For Attaching Chrome  
Floor Strips  
Ford

UNIT PACKAGE: 100



**9229**

(4879431)  
Zinc

#8-18 x 7/16"  
Phillips Washer Head  
Pozi-Drive  
9/32" Washer Head O.D.  
Wheel Mouldings  
GM

UNIT PACKAGE: 100



**13708**

(9422202)  
Zinc

#8 x 1/2"  
Phillips Flat Top Wshr Hd  
13/32" Washer Head O.D.  
Chrysler

UNIT PACKAGE: 100



**16997**

Same As 10642  
With Black E-Coat  
(168 Hours Salt Spray)

#8 x 3/8"  
Phillips Oval Washer Head  
3/8" Washer Head O.D.  
Wheel Opening Mouldings

UNIT PACKAGE: 100



**12062**

(11501903)  
Black Oxide

M4.2-1.41 x 10mm  
(#8 x 13/32")  
Phillips Washer Head  
Pozi-Drive  
11mm (7/16")  
Washer Hd. O.D.  
GM

UNIT PACKAGE: 100



**1826**

Chrome

#8 x 7/16"  
Phillips Truss Head  
13/32" Head Diameter  
UNIT PACKAGE: 100



**12213**

(11503421, 11503636)  
Black  
E-Coat

#8-18 x 1/2"  
Phillips Flat Washer Head  
13/32" Washer Head O.D.  
GM

UNIT PACKAGE: 100



**9863**

Zinc

#8-18 x 3/8"  
Phillips Round Washer  
Head  
9/32" Head Dia.  
Chrysler

UNIT PACKAGE: 100



**2805**

Zinc

#8 x 7/16"  
Phillips Washer Head  
3/8" Washer Head O.D.

UNIT PACKAGE: 100



**15941**

Black Oxide

M4.2-1.41 x 12mm  
(#8 x 15/32")  
Phillips Truss Head  
9.5mm (3/8")  
Head Diameter  
Japanese Imports  
UNIT PACKAGE: 10

**16596**

Same As 15941  
Except For Unit Package  
UNIT PACKAGE: 100



**The World's Largest  
Selection Of Body  
Hardware & Specialty  
Fasteners For The  
Collision Repair  
Professional**

# SPECIAL TAPPING SCREWS

**Sec. 4**



**13025**

(56910-S2)  
Phosphate

#8 x 1/2"  
Phillips Washer Head  
31/64" Washer Head O.D.  
Ford

UNIT PACKAGE: 100



**12095**

(1689827)  
Zinc

#8 x 1/2"  
Phillips Washer Head  
with Teks® Point  
7/16" Washer Head O.D.  
Reveal Moulding To Panel  
GM

UNIT PACKAGE: 50



**12059**

(11501883)  
Zinc

M4.2-1.41 x 13mm  
(#8 x 33/64")  
Phillips Washer Head  
11mm (7/16") Washer  
Head O.D.  
GM

UNIT PACKAGE: 100



**12743**

(11502843)  
Zinc

M4.2 -1.41 x 13mm  
(#8 x 33/64")  
Hex Washer Head  
11mm (7/16") Washer O.D.  
7mm Hex  
GM

UNIT PACKAGE: 100



**20375**

Black Phosphate

#8 x 1/2"  
Phillips Round  
Washer Head  
1/2" Head Diameter  
UNIT PACKAGE: 100



**15774**

(GM: 20423550)  
(Ford: 381801-S2,  
390017-S2)  
Black Phosphate

#8 x 1/2"  
Phillips Washer Head  
With Teks® Point  
7/16" Washer Head O.D.  
GM & Ford

UNIT PACKAGE: 50



**12061**

(11501896)  
Black Oxide

M4.2-1.41 x 13mm  
(#8 x 33/64")  
Phillips Round  
Washer Head  
Pozi-Drive  
8.5mm (11/32")  
Washer Hd. O.D.  
GM

UNIT PACKAGE: 100



**15721**

(11504010)  
Phosphate

M4.2-1.41 x 13mm  
(#8 x 19/32")  
Indented Hex Head Sems®  
16mm (5/8") Washer O.D.  
7mm Hex  
GM

UNIT PACKAGE: 50



**15172**

Zinc

#8 x 1/2"  
Phillips Washer Head  
With #2 Teks® Point  
13/32" Washer Head O.D.

UNIT PACKAGE: 100



**16478**

(153297)  
Black

#8-18 x 1/2"  
Phillips Flat Top  
Round Washer Head Teks®  
13/32" Washer Head O.D.  
Chrysler

UNIT PACKAGE: 100



**13712**

(11505104)  
Black Zinc

M4.2-1.41 x 13mm  
(#8 x 33/64")  
Phillips Washer Head  
11mm (7/16")  
Washer Hd. O.D.  
GM

UNIT PACKAGE: 50



**18781**

(11515566)  
Phosphate

M4.2-1.41 x 14mm  
(#8 x 9/16")  
Hex Head Sems®  
8mm (5/16") Washer O.D.  
7mm Hex  
GM

UNIT PACKAGE: 50



**2806**

Chrome

#8 x 5/8"  
Phillips Round Washer Hd  
13/32" Washer Head O.D.

UNIT PACKAGE: 100



**15171**

Zinc

#8 x 1/2"  
Phillips Low Profile  
Round Washer Head  
With #2 Teks® Point  
23/64" Washer Head O.D.

UNIT PACKAGE: 100



**17083**

(11503289)  
Chrome

#8 x 1/2"  
Phillips Round Washer  
Head Teks®  
With Sealer On Thread  
Pozi-Drive  
11/32" Washer Head O.D.  
GM

UNIT PACKAGE: 50



**12740**

(11503394)  
Phosphate

M4.2-1.41 x 13mm  
(#8 x 33/64")  
Hex Head Sems®  
12mm (15/32") Washer  
O.D.  
7mm Hex  
GM

UNIT PACKAGE: 100



**13711**

(56911-S2, 56929-S2)  
Phosphate

#8 x 5/8"  
Phillips Washer Head  
31/64" Washer Head O.D.  
Ford

UNIT PACKAGE: 100

**Sec. 4****SPECIAL TAPPING SCREWS****18817**  
(1746408)  
Zinc & BlackM4.2-1.41 x 16mm  
(#8 x 41/64")  
Phillips Round Washer Hd  
w/Serrations Under The Hd  
Pozi-Drive With Teks® Point  
11mm (7/16") Wshr Hd O.D.  
Moulding, Trim & General  
Purpose  
GM

UNIT PACKAGE: 100

**18261**  
(11503578,  
11503785)  
PhosphateM4.2-1.41 x 16mm  
(#8 x 5/8")  
Hex Washer Head Sems®  
With Teks® Point  
12mm (1/2") Washer O.D.  
7mm Hex  
GM

UNIT PACKAGE: 50

**17460**  
(382413-S9)  
Zinc#8 x 3/4"  
Phillips Round Washer Hd  
With Teks® Point  
7/16" Washer Head O.D.  
Door Scuff Plate  
Ford

UNIT PACKAGE: 50

**12060**  
(11501884)  
Black OxideM4.2-1.41 x 20mm  
(#8 x 25/32")  
Phillips Washer Head  
Pozi-Drive  
11mm (7/16") Washer O.D.  
GM

UNIT PACKAGE: 100

**16720**  
Black OxideM4.2-1.41 x 16mm  
(#8 x 5/8")  
Phillips Truss Head  
9.5mm (3/8") Head O.D.  
Honda

UNIT PACKAGE: 100

**13687**  
Zinc#8 x 3/4"  
Phillips Wshr Hd; Pozi-Drive  
9/32" Washer Head O.D.

UNIT PACKAGE: 100

**17650**  
Phosphate#8 x 3/4"  
Phillips Round Washer Hd  
With Teks® Point  
7/16" Washer Hd. O.D.

UNIT PACKAGE: 50

**12097**  
(9420052,11502483)  
ChromeM4.2-1.41 x 20mm  
(#8 x 25/32")  
Phillips Pan Head Sems®  
Pozi-Drive  
12mm (1/2") Washer O.D.  
GM

UNIT PACKAGE: 50

**17483**  
(90082-35011)  
Zinc & BlackM4.2-1.41 x 16mm  
(#8 x 5/8")  
Phillips Round Washer Hd  
10mm (25/64")  
Washer Head O.D.  
Door Panel Arm Rests,  
Power Windows & Locks  
Toyota Camry

UNIT PACKAGE: 100

**16538**  
6031495)  
Mechanical Cadmium Tin#8-18 x 3/4"  
Phillips Oval Head  
With Teks® Point  
5/16" Head Diameter  
Trim Panel  
Chrysler

UNIT PACKAGE: 50

**16531**  
(154508)  
Decorative Black#8-15 x 3/4"  
Phillips Flat Top  
Self-Piercer; With Sealer  
9/32" Head Diameter  
Quarter Panel Side  
Reflector  
Chrysler

UNIT PACKAGE: 50

**12738**  
(11504056, 11513801)  
PhosphateM4.2-1.41 x 20mm  
(#8 x 25/32")  
Hex Washer Head Sems®  
12mm (1/2") Washer O.D.  
7mm Hex  
Radiator & Grille  
GM

UNIT PACKAGE: 50

**12741**  
(11503395)  
PhosphateM4.2-1.41 x 16mm  
(#8 x 5/8")  
Hex Head Sems®  
12mm (15/32") Wshr O.D.  
7mm Hex  
GM

UNIT PACKAGE: 100

**13026**  
(56912-S2)  
Phosphate#8 x 3/4"  
Phillips Washer Head  
31/64" Washer Head O.D.  
Ford

UNIT PACKAGE: 100

**16534**  
(154534)  
Black Zinc#8-18 x 3/4"  
Phillips Pan Head  
With Teks® Point & Sealer  
5/16" Head Diameter  
Cargo Door Scuff Plate  
Chrysler Full Size Van

UNIT PACKAGE: 50

**12742**  
(11503396, 11503483)  
PhosphateM4.2-1.41 x 20mm  
(#8 x 25/32")  
Hex Head Sems®  
12mm (1/2") Washer O.D.  
7mm Hex  
Front End & Air Cond.  
GM

UNIT PACKAGE: 100

**18523**  
(N800322-S55)  
Black375 Hour Salt Spray  
M4.2-1.41 x 16mm  
(#8 x 5/8")  
Hex Head Sems®  
12mm (15/32") Wshr O.D.  
5mm Hex  
Ford

UNIT PACKAGE: 50

# SPECIAL TAPPING SCREWS

## Sec. 4



**15373**  
(1640810, 11503892,  
11500434)  
Phosphate  
M4.2-1.41 x 20mm  
(#8 x 25/32")  
Hex Head Sems®  
16mm (5/8") Washer O.D.  
7mm Hex  
GM  
UNIT PACKAGE: 50



**15775**  
Phosphate  
M4.2-1.41 x 20mm  
(#8 x 25/32")  
Hex Head Sems®  
With Teks® Point  
12mm (1/2") Washer O.D.  
7mm Hex  
UNIT PACKAGE: 50



**20376**  
Black Phosphate  
#8 x 1"  
Phillips Round  
Washer Head  
1/2" Head Diameter  
UNIT PACKAGE: 100



**19778**  
Zinc  
#8 x 1-1/4"  
Phillips Round Washer  
Head  
With Teks® Point  
7/16" Washer Head O.D.  
General Purpose  
UNIT PACKAGE: 50



**20271**  
Phosphate  
M4.2-1.41 x 20mm  
(#8 x 25/32")  
Phillips Pan Head Sems®  
16mm (5/8") Washer O.D.  
Ford  
UNIT PACKAGE: 50



**18296**  
Zinc  
#8 x 1"  
Phillips Round Washer Hd  
With Teks® Point  
7/16" Washer Head O.D.  
General Purpose  
UNIT PACKAGE: 50



**18336**  
Phosphate  
M4.2-1.41 x 25mm  
(#8 x 1")  
Hex Head Sems®  
12mm (1/2") Washer O.D.  
7mm Hex  
UNIT PACKAGE: 100



**2178**  
Zinc  
#10 x 3/8"  
Phillips Round Wshr Hd  
31/64" Washer Head O.D.  
UNIT PACKAGE: 100



**20476**  
Phosphate  
M4.2-1.41 x 20mm  
(#8 x 25/32")  
Hex Washer Head  
Sems® Teks®  
17mm (11/16") Washer O.D.  
7mm Hex  
General Purpose  
UNIT PACKAGE: 50



**19006**  
Phosphate  
M4.2-1.41 x 25mm  
(#8 x 1")  
Round Washer Head  
Pozi-Drive  
With Teks® Point  
11mm (7/16") Washer Hd.  
O.D.  
General Purpose  
UNIT PACKAGE: 100



**19653**  
(N811534-S61)  
Black Phosphate  
M4.2-1.41 x 30mm  
(#8 x 1-3/16")  
Hex Head Sems®  
17mm (11/16") Washer  
O.D.  
7mm Hex  
Ford  
UNIT PACKAGE: 15



**2028**  
Zinc  
#10 x 1/2"  
Phillips Round Head  
11/32" Head Diameter  
UNIT PACKAGE: 100



**13027**  
9428273)  
Zinc  
#10 x 1/2"  
Phillips Flat Washer Head  
15/32" Washer Head O.D.  
Chrysler  
UNIT PACKAGE: 100



**19278**  
(14090382)  
Black Phosphate  
M4.2-1.41 x 20mm  
(#8 x 25/32")  
Hex Head Sems  
20mm (25/32") Washer O.D.  
7mm Hex  
GM  
UNIT PACKAGE: 50



**20382**  
Not Available  
From O.E.M.  
Black Zinc  
M4.2-1.41 x 25mm  
(#8 x 1")  
Torx® Pan Head Sems®  
T-15 Drive  
12mm (1/2") Washer O.D.  
UNIT PACKAGE: 50



**18460**  
Phosphate  
#8 x 1-1/4"  
Phillips Oval Head  
Sems® Flush Washer  
With #2 Teks® Point  
Interior Trim  
UNIT PACKAGE: 50



**15827**  
(9423950)  
Phosphate  
#10 x 1/2"  
Phillips Flat Washer Head  
15/32" Washer Head O.D.  
Chrysler  
UNIT PACKAGE: 100

**Sec. 4****SPECIAL TAPPING SCREWS****18340**

Black Phosphate

M4.8-1.6 x 15mm  
 (#10 x 19/32")  
 Phillips Truss Head  
 14mm Head O.D.  
 Nissan Bumpers  
 UNIT PACKAGE: 50

**13709**(9427977)  
Zinc

#10 x 3/4"  
 Phillips Flat Top  
 Washer Head  
 15/32" Washer Head O.D.  
 Chrysler  
 UNIT PACKAGE: 40

**16589**

Zinc &  
 Yellow Dichromate  
 #10 x 3/4" (19mm)  
 Indented Hex Head Sems®  
 Washer O.D.: 19/32"  
 5/16" (8mm) Hex  
 Honda, Nissan, Toyota  
 UNIT PACKAGE: 50

**19181**(W700501-S303)  
Black Organic

M5-2.2 x 15mm  
 (#12 x 19/32")  
 Torx® Pan Head Sems®  
 20mm (25/32")  
 Washer O.D.  
 12mm (1/2") Head O.D.  
 T-30 Drive  
 Ford Contour & Mystique  
 1995-On  
 UNIT PACKAGE: 50

**20364**

Zinc

#10 x 5/8"  
 Phillips Washer Head  
 With Tek® Point  
 Serrations Under The  
 Washer  
 7/16" Washer Head O.D.  
 GM  
 UNIT PACKAGE: 100

**18494**(6035204)  
Decorative Black

#10 x 3/4"  
 Torx® Round Washer Head  
 15/32" Washer Head O.D.  
 T-25 Drive  
 Slider Bracket Attachment  
 To Front & Rear Fascia  
 Dodge & Plymouth Neon  
 1995-On  
 UNIT PACKAGE: 40

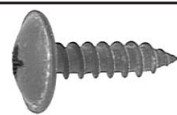
**20455**

Black Phosphate

M4.8-2.12 x 20mm  
 (#10 x 25/32")  
 Phillips Truss Head  
 14mm Head O.D.  
 Imports  
 UNIT PACKAGE: 50

**17461**

Zinc &amp; Yellow Dichromate

M5.5-1.81 x 18mm  
 (#12 x 45/64")  
 Hex Head Sems®  
 15mm (19/32") Wshr O.D.  
 8mm Hex  
 Imports  
 UNIT PACKAGE: 50

**17459**

Black Oxide

M4.8-1.61 x 16mm  
 (#10 x 5/8")  
 Phillips Truss Head  
 11mm (7/16") Head O.D.  
 Imports  
 UNIT PACKAGE: 100

**19240**

Black E-Coat

#10 x 3/4"  
 Phillips Flat Top  
 Round Washer Head  
 1/2" Washer Head O.D.  
 General Purpose  
 UNIT PACKAGE: 100

**19237**(W701649-S,  
W704881-S300)  
Black Nylon

Cowl Top Vent Grille  
 Nylon Screw  
 #10 x 1-1/32"  
 9/16" Head O.D.  
**Use With Auveco 19238**  
 Ford Taurus & Sable  
 1996-On  
 UNIT PACKAGE: 50

**12318**(11502453,  
11508797)  
Zinc

M6.3-1.81 x 13mm  
 (#14 x 33/64")  
 Hex Washer Head 12.5mm  
 (1/2") Washer Hd. O.D.  
 10mm Hex  
 GM  
 UNIT PACKAGE: 50

**20259**(90114-SE0-000)  
Black E-Coat

M4.8-1.61 x 19mm  
 (#10 x 3/4")  
 Phillips Truss Head Sems®  
 Washer O.D.: 16mm  
 Splash Shield & General  
 Purpose  
 Honda 1986 - On  
 UNIT PACKAGE: 25

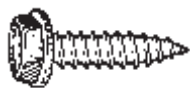
**13022**(9419322)  
Phosphate

#10 x 3/4"  
 Hex Washer Head  
 25/64" Washer Head O.D.  
 5/16" Hex  
 Chrysler  
 UNIT PACKAGE: 100

**19517**(N811849-S300)  
Black Nylon

Cowl Top  
 Vent Grille  
 Nylon Screw  
 #10 x 2-1/16"  
 9/16" Head O.D.  
 Ford Trucks  
 1998-On  
 UNIT PACKAGE: 25



# SPECIAL TAPPING SCREWS

**Sec. 4**



**12319**

(11502873)  
Phosphate

M6.3-1.81 x 13mm  
(#14 x 33/64")  
Hex Wshr Hd; Type B  
12.5mm (1/2") Washer  
Head O.D.; 10mm Hex  
GM

UNIT PACKAGE: 50



**12057**

(11500994,  
11509371)  
Phosphate

M6.3-1.81 x 16mm  
(#14 x 41/64")  
Hex Head Sems®  
17mm (11/16") Wshr O.D.  
10mm Hex  
GM

UNIT PACKAGE: 50



**13019**

(N610959-S2)  
Phosphate

M6.3-1.81 x 19mm  
(#14 x 3/4")  
Hex Washer Head  
11.5mm (29/64")  
Washer Hd. O.D.  
8mm Hex  
Ford

UNIT PACKAGE: 50



**20557**

Black Zinc

M6.3-1.81 x 20mm  
(#14 x 25/32")  
Phillips Hex Head Sems®  
20mm (25/32") Washer O.D.  
10mm Hex  
Imports

UNIT PACKAGE: 50



**19718**

(6501220)

Mechanical Zinc  
& Yellow Chromate

M6.3-1.81 x 16mm  
(#14 x 5/8")  
Torx® Drive Oval Head  
T-30 Drive  
13mm (1/2") Head O.D.  
Door Latch Mounting  
Chrysler  
1986-On

UNIT PACKAGE: 50

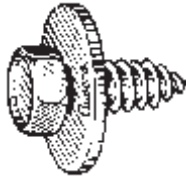

**15962**

Zinc & Yellow Dichromate

M6.3-1.81 x 18mm  
(#14 x 23/32")  
Hex Head Sems®  
22mm (7/8") Washer O.D.  
10mm Hex  
Honda, Nissan, Toyota

UNIT PACKAGE: 25



**20556**

Black Zinc

M6.3-1.81 x 20mm  
(#14 x 25/32")  
Phillips Hex Head Sems®  
16mm (5/8") Washer O.D.  
10mm Hex  
Imports

UNIT PACKAGE: 50



**18934**

(6034703,  
6035188)  
Zinc Organic

#14 x 7/8"  
Hex Washer Head  
Serrations Under The  
Washer Head  
13/16" Washer Head O.D.  
3/8" Hex  
Front Fender & Fascia  
Attachment  
Chrysler 1993-On

UNIT PACKAGE: 25



**19170**

Black Phosphate

M6.3-1.81 x 16mm  
(#14 x 5/8")  
Phillips Truss Head  
15mm (19/32") Head O.D.  
Japanese Imports

UNIT PACKAGE: 50



**2219**

Zinc

#14 x 3/4"  
Slotted Truss Head  
9/16" Head Diameter

UNIT PACKAGE: 100

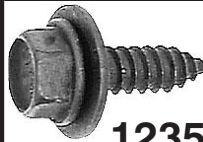

**12351**

(11505022)

Black Polyseal Finish

M6.3-1.81 x 20mm  
(#14 x 25/32")  
Hex Washer Head Sems®  
17mm (11/16") Wshr O.D.  
10mm Hex  
GM

UNIT PACKAGE: 50

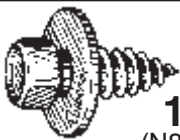

**15776**

(N800312-S2)  
Phosphate

M6.3-1.81 x 16mm  
(#14 x 41/64")  
Hex Head Sems®  
16mm (5/8") Washer O.D.  
8mm Hex; Ford

UNIT PACKAGE: 50



**13021**

(55914-S2)  
Phosphate

#14 x 3/4"  
Hex Washer Head  
1/2" Washer Head O.D.  
3/8" Hex  
Ford

UNIT PACKAGE: 50



**16828**

Zinc & Yellow  
Dichromate

M6.3-1.81 x 20mm  
(#14 x 25/32")  
Hex Head Sems®  
18mm (45/64")  
Washer O.D.  
10mm Hex

Honda, Nissan & Toyota

UNIT PACKAGE: 25

**“You can’t find a  
place to save a  
million dollars.  
But there are a  
million places  
to save a  
dollar.”**

**“Pop” Gale**

**Sec. 4****SPECIAL TAPPING SCREWS****12339**(11500996, 11505023)  
PhosphateM6.3-1.81 x 25mm  
(#14 x 1")  
Hex Head Sems®  
17mm (21/32") Wshr O.D.  
10mm Hex  
GM

UNIT PACKAGE: 50

**12354**(11500997)  
PhosphateM6.3-1.81 x 30mm  
(#14 x 1-3/16")  
Hex Head Sems®  
17mm (21/32")  
Washer O.D.  
10mm Hex  
GM

UNIT PACKAGE: 50

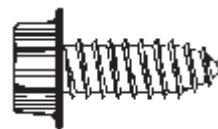
**12350**(11500086)  
PhosphateM8-2.12 x 20mm  
(5/16"-12 x 25/32")  
Hex Washer Head  
16mm (5/8") Washer Hd. O.D.  
13mm Hex  
GM

UNIT PACKAGE: 25

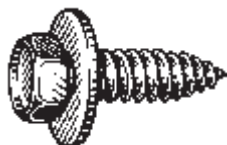
**12352**(11504515)  
ZincM6.3-1.81 x 25mm  
(#14 x 1")  
Hex Head Sems®  
17mm (21/32")  
Washer O.D.  
10mm Hex  
GM

UNIT PACKAGE: 50

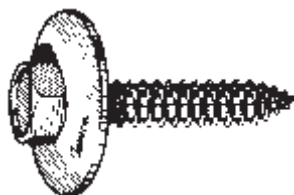
**12068**(11504981)  
PhosphateM6.3-1.81 x 30mm  
(#14 x 1-3/16")  
Hex Head Sems®  
24mm (15/16") Washer O.D.  
10mm Hex  
GM

UNIT PACKAGE: 50

**10364**

Black Oxide

5/16"-12 x 7/8"  
Hex Washer Head  
21/32" Washer Head O.D.  
1/2" Hex

UNIT PACKAGE: 100

**12347**(11500081, 11508905)  
PhosphateM6.3-1.81 x 30mm  
(#14 x 1-3/16")  
Hex Washer Head  
11.5mm (29/64")  
Washer Hd. O.D.  
10mm Hex  
GM

UNIT PACKAGE: 50

**19417**(6503819, 6503401)  
Black NylonM7.5 x 35mm  
Square Drive Truss Head  
22mm Head Diameter  
9mm Shoulder Diameter  
Foam To Bumper Fascia  
Chrysler  
1993-On

UNIT PACKAGE: 15

**10714**(9796223)  
Phosphate5/16"-12 x 1"  
Hex Washer Head  
21/32" Washer Head O.D.  
1/2" Hex  
GM

UNIT PACKAGE: 50

**LICENSE PLATE FASTENERS**  
(ILLUSTRATIONS ACTUAL SIZE)



**18156**  
(51-81-1-821-830)  
Zinc & Yellow  
M4.8-1.59 x 16mm  
(#10 x 5/8")  
Phillips Wafer Head  
License Plate Screw  
10mm (3/8") Head O.D.  
BMW  
UNIT PACKAGE: 50



**5278**  
(3783002)  
Zinc  
#10 x 5/8"  
Slotted Truss Washer Head  
License Plate Screw  
1/2" Washer Head O.D.  
GM  
Use With Auveco Nut 5228  
UNIT PACKAGE: 100



**17558**  
Black E-Coat  
(168 Hours Salt Spray)  
#10 x 3/4"  
Phillips Flat Washer Head  
License Plate Screw  
15/32" Washer Hd. O.D.  
UNIT PACKAGE: 100



**18779**  
Zinc & Yellow Dichromate  
M5-0.8 x 12mm  
Phillips Pan Washer Head  
License Plate Screw  
12.7mm (1/2")  
Washer Hd. O.D.  
Ford Contour & Mercury  
Mystique  
1995-On  
UNIT PACKAGE: 100



**17315**  
Zinc & Clear  
M6-1.0 x 12mm  
Hex Flange  
License Plate Screw  
14mm (9/16") Flange O.D.  
10mm Hex  
Class 10.9  
Acura  
UNIT PACKAGE: 50



**5908**  
Zinc  
1/4"-20 x 1/2"  
Slotted Round Head  
License Plate Screw  
9/16" Head Diameter  
UNIT PACKAGE: 100



**5909**  
Zinc  
1/4"-20 x 1/2"  
Slotted Round Wshr Head  
License Plate Screw  
9/16" Washer Head O.D.  
UNIT PACKAGE: 100



**17098**  
Zinc & Yellow Dichromate  
M6-1.81 x 15mm  
(1/4"-14 x 19/32")  
Phillips Truss Head  
License Plate Screw  
13mm (1/2") Head Dia.  
UNIT PACKAGE: 50



**15758**  
Zinc  
#14 x 5/8"  
Slotted Truss Head  
With Dog Point  
License Plate Screw  
9/16" Head O.D.  
UNIT PACKAGE: 50



**8249**  
Zinc  
1/4" x 5/8"  
Slotted Round Wshr Head  
License Plate Screw  
9/16" Washer Head O.D.  
Use With Auveco Nut 8242  
UNIT PACKAGE: 100



**16421**  
(N800369-S2)  
Black E-Coat  
#14 (1/4") x 5/8"  
Slotted Hex Washer Head  
License Plate Screw  
5/8" Washer Head O.D.  
5/16" Hex  
Ford  
UNIT PACKAGE: 50



**16422**  
(N800369)  
Zinc  
#14 (1/4") x 5/8"  
Slotted Hex Washer Head  
License Plate Screw  
5/8" Washer Head O.D.  
5/16" Hex  
Ford  
UNIT PACKAGE: 50



**20446**  
Black E-Coat  
#14 (1/4") x 5/8"  
Slotted Hex Washer Head  
License Plate Screw  
5/8" Washer Head O.D.  
5/16" Hex  
Ford  
UNIT PACKAGE: 50



**17980**  
Zinc & Yellow Dichromate  
M6-1.81 x 16mm  
(1/4"-14 x 5/8")  
Phillips Hex Washer Head  
License Plate Screw  
13mm (1/2") Washer Head  
O.D.  
10mm Hex  
UNIT PACKAGE: 50



**17316**  
Zinc & Clear  
M6-1.0 x 16mm  
Hex Flange  
License Plate Screw  
14mm (9/16") Flange O.D.  
10mm Hex  
Class 10.9  
Acura  
UNIT PACKAGE: 50



**14473**  
Zinc  
M6-1.0 x 16mm  
Slotted Round Washer  
Head  
License Plate Screw  
14mm (9/16") Washer  
Head O.D.  
UNIT PACKAGE: 50



**17152**  
Black E-Coat  
(168 Hours Salt Spray)  
M6-1.0 x 16mm  
Slotted Round Wshr Hd  
License Plate Screw  
14mm (9/16")  
Washer Head O.D.  
UNIT PACKAGE: 50



**19777**  
Dacromet 320  
M6.3-1.81 x 16mm  
(#14 x 5/8")  
Duo-Drive Truss Head  
License Plate Screw  
14mm Head Diameter  
GM  
UNIT PACKAGE: 50



**5910**  
Zinc  
1/4"-20 x 3/4"  
Slotted Truss Head  
License Plate Screw  
9/16" Head Diameter  
UNIT PACKAGE: 100

## Sec. 5

# LICENSE PLATE FASTENERS

(ILLUSTRATIONS ACTUAL SIZE)



**9603**  
Zinc

#14 x 3/4"  
Slotted Truss Head  
License Plate Screw  
9/16" Head Diameter  
UNIT PACKAGE: 100



**16323**  
Black E Coat  
(168 Hours Salt Spray)

#14 x 3/4"  
Slotted Truss Head  
License Plate Screw  
9/16" Head Diameter  
UNIT PACKAGE: 100



**18769**  
Black E-Coat  
(168 Hours Salt Spray)

M6-1.0 x 20mm  
Phillips Pan Head  
License Plate Screw  
12mm (15/32") Head Dia.  
UNIT PACKAGE: 50

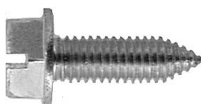

**16826**  
(Chry: 34201287;  
AMC: 8934201287)  
Zinc

M6-1.0 x 20mm  
Slotted Hex Washer Head  
License Plate Screw  
13mm (1/2") Wshr Hd.  
O.D.  
10mm Hex  
Chrysler, Honda & AMC  
UNIT PACKAGE: 50



**16960**  
(Toyota: 93904-46320)  
(Honda:  
91500-SM4-999AH)  
Zinc & Yellow Dichromate

M6-1.81 x 20mm  
(1/4"-14 x 3/4")  
Phillips Hex Washer Head  
License Plate Screw  
12mm (1/2")  
Wshr Hd. O.D.  
10mm Hex  
Honda 1990-On  
GEO Prizm, Toyota  
UNIT PACKAGE: 50

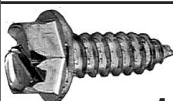

**11369**  
Zinc

#14 x 3/4"  
Slotted Hex Washer Head  
License Plate Screw  
1/2" Washer Head O.D.  
3/8" Hex  
Ford  
UNIT PACKAGE: 50



**18354**  
Black E-Coat  
(168 Hours Salt Spray)

#14 x 3/4"  
Slotted Hex Washer Head  
License Plate Screw  
1/2" Washer Head O.D.  
3/8" Hex  
Ford  
UNIT PACKAGE: 50



**20301**  
(16502342)  
Black E-Coat  
(168 Hours Salt Spray)

#14 x 1-3/16"  
Slotted Truss Head  
License Plate Screw  
9/16" Head Diameter  
GM S & T Trucks  
1998 - On  
UNIT PACKAGE: 50



**15170**  
#14 x 1/2"  
Dealer License Plate  
Thumb Screw  
1-1/8" Overall Length  
UNIT PACKAGE: 25



**1313**  
Zinc

1/4"-20 x 1/2"  
Slotted Truss Head  
License Plate Screw  
With Hex Nut  
9/16" Head Diameter  
7/16" Hex Width (ATF)  
UNIT PACKAGE: 100 Sets



**3184**  
Zinc

1/4"-20 x 1/2"  
Slotted Truss Head  
License Plate Screw  
With Square Nut  
9/16" Head Diameter  
7/16" ATF  
UNIT PACKAGE: 100 Sets



**3182**  
Zinc

1/4"-20 x 1/2"  
Slotted Round  
Washer Head  
License Plate Screw  
With Hex Nut  
9/16" Washer Head O.D.  
7/16" Hex Width (ATF)  
UNIT PACKAGE: 100 Sets



**3183**  
Zinc

1/4"-20 x 1/2"  
Slotted Round Washer Hd  
License Plate Screw  
With Square Nut  
9/16" Washer Head O.D.  
7/16" ATF  
UNIT PACKAGE: 100 Sets



**5885**  
Zinc

1/4"-20 x 1/2"  
Slotted Round  
Washer Head  
License Plate Screw  
With Flat Washer  
And Wing Nut  
9/16" Washer Head O.D.  
5/8" Washer O.D.  
UNIT PACKAGE: 50 Sets



**8250**  
Zinc

1/4" x 5/8"  
Slotted Round Wshr Head  
License Plate Screw  
And Nylon Nut  
(Auveco No. 8249 & 8242)  
9/16" Washer Head O.D.  
Chrysler  
UNIT PACKAGE: 25 Sets



**8427**  
(379046-S)  
Zinc

1/4"-20 x 5/8"  
Slotted Pan Head  
Type "F" Thread Cutting  
License Plate Screw  
And Nylon Nut  
(Auveco No. 5307 & 3682)  
1/2" Head Diameter  
UNIT PACKAGE: 50 Sets

**LICENSE PLATE FASTENERS**  
(ILLUSTRATIONS ACTUAL SIZE)



**2472**  
Zinc  
1/4"-20 x 3/4"  
Slotted Truss Head  
License Plate Screw  
With Square Nut  
9/16" Head Diameter  
7/16" ATF  
UNIT PACKAGE: 100 Sets



**11370**  
Zinc  
#14 x 3/4"  
Slotted Hex Washer Head  
License Plate Screw  
And Nylon Nut  
(Auveco # 11368 &  
11369)  
1/2" Washer Head O.D.  
3/8" Hex  
Ford  
UNIT PACKAGE: 25 Sets



**13922**  
Natural Nylon  
1/4"-20 x 5/8"  
Slotted Truss  
Washer Head  
Nylon License Plate Screw  
And Nylon Washer Nut  
19/32" Washer Head O.D.  
9/16" Washer Nut O.D.  
7/16" Hex Width (ATF)  
UNIT PACKAGE: 25 Sets

**17171**  
Screw Only From 13922  
UNIT PACKAGE: 50

**18342**  
Screw Only From 13922  
UNIT PACKAGE: 1000

**17228**  
Nut Only From 13922  
UNIT PACKAGE: 50

**18346**  
Nut Only From 13922  
UNIT PACKAGE: 1000



**18484**  
Black Nylon  
1/4"-20 x 5/8"  
Slotted Truss  
Washer Head  
Nylon License Plate Screw  
And Nylon Washer Nut  
19/32" Washer Head O.D.  
9/16" Washer Nut O.D.  
7/16" Hex Width (AFT)  
UNIT PACKAGE: 25

**18485**  
Screw Only From 18484  
UNIT PACKAGE: 50

**18486**  
Screw Only From 18484  
UNIT PACKAGE: 1000

**18487**  
Nut Only From 18484  
UNIT PACKAGE: 50

**18488**  
Nut Only From 18484  
UNIT PACKAGE: 1000



**15413**  
Black Nylon  
M6-1.0 x 20mm  
Slotted Pan Head  
Nylon License Plate Screw  
And Nylon Hex Nut  
12mm (15/32") Head Dia.  
10mm (25/64") Hex Width  
(ATF)  
UNIT PACKAGE: 50 Sets

**17091**  
Screw Only From 15413  
UNIT PACKAGE: 100

**18344**  
Screw Only From 15413  
UNIT PACKAGE: 1000

**18348**  
Nut Only From 15413  
UNIT PACKAGE: 1000



**13934**  
Natural Nylon  
M6-1.0 x 20mm  
Slotted Pan Head  
Nylon License Plate Screw  
And Nylon Hex Nut  
12mm (15/32") Head Dia.  
10mm (25/64") Hex Width  
(ATF)  
UNIT PACKAGE: 25 Sets

**17169**  
Screw Only From 13934  
UNIT PACKAGE: 100

**18343**  
Screw Only From 13934  
UNIT PACKAGE: 1000

**18347**  
Nut Only From 13934  
UNIT PACKAGE: 1000



**18239**  
Natural Nylon  
M6-1.0 x 25mm  
Slotted Pan Head  
Nylon License Plate Screw  
And Nylon Hex Nut  
12mm (15/32") Head Dia.  
10mm (25/64") Hex Width  
(AFT)  
UNIT PACKAGE: 25

**18238**  
Screw Only From 18239  
UNIT PACKAGE: 50



**18241**  
Black Nylon  
M6-1.0 x 25mm  
Slotted Pan Head  
Nylon License Plate Screw  
And Nylon Hex Nut  
12mm (15/32") Head Dia.  
10mm (25/64") Hex Width  
(AFT)  
UNIT PACKAGE: 25

**18240**  
Screw Only From 18241  
UNIT PACKAGE: 50



**13935**  
Natural Nylon  
M8-1.25 x 20mm  
Slotted Pan Head  
Nylon License Plate Screw  
And Nylon Hex Nut  
16mm (5/8") Head Dia.  
8mm (5/16") Hex Width (ATF)  
UNIT PACKAGE: 25 Sets

**18345**  
Screw Only From 13935  
UNIT PACKAGE: 1000

**18349**  
Nut Only From 13935  
UNIT PACKAGE: 1000

**Sec. 5**

**LICENSE PLATE FASTENERS**

(ILLUSTRATIONS ACTUAL SIZE)



**16669**

Bagged Hardware

2 Pieces Each of 9603 (#14 x 3/4" Slotted Truss Head Screw) And 11719 (Nylon Nut) Packaged In Unmarked, See-Thru Plastic Bags.

UNIT PACKAGE: 50 Sets



**16670**

Bagged Hardware

4 Pieces Each of 9603 (#14 x 3/4" Slotted Truss Head Screw) And 11719 (Nylon Nut) Packaged In Unmarked, See-Thru Plastic Bags.

UNIT PACKAGE: 50 Sets

**16690**

Same As 16670 Except For Unit Package Quantity

UNIT PACKAGE: 100 Sets

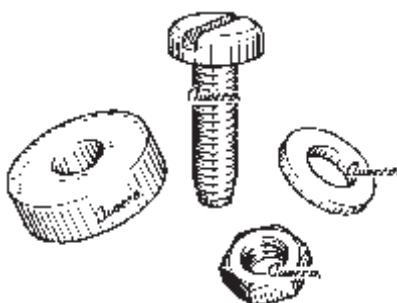

**16800**

Nylon Screw, Spacer & Washer Brass Nut

M6-1.0 x 20mm Slotted Pan Head License Plate Screw & Hardware  
12mm (15/32") Head Dia.  
10mm (25/64") Hex Width (ATF)  
12.5mm (1/2") Washer O.D.  
19mm (3/4") Spacer O.D.  
Toyota

UNIT PACKAGE: 25 Sets



**17636**

Nylon

License Plate Bracket Spacer  
1/4" (6mm) I.D.  
3/4" (19mm) O.D.  
1/4" (6mm) Thick  
Toyota

UNIT PACKAGE: 50



**2625**

Nylon

#8 Screw Size License Plate Nut & Headlight Door Mounting Screw Nut  
Chrysler

UNIT PACKAGE: 100



**5228**

(3783006)  
Nylon

#10 Screw Size License Plate Nut  
GM  
Use With Auveco Screw 5278

UNIT PACKAGE: 50



**13466**

(6032516)  
Black Nylon

License Plate Nut  
#12 Screw Size  
Chrysler

UNIT PACKAGE: 25

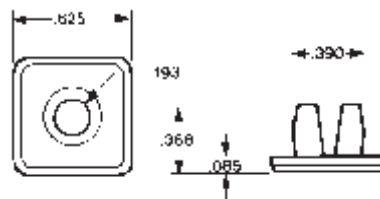

**3682**

(1196781)  
Nylon

1/4"-20 Screw Size License Plate Nut  
GM  
Use With Auveco Screw 5307

UNIT PACKAGE: 50

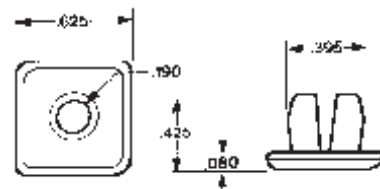

**8435**

(4755299)  
Nylon

1/4" (#14) Screw Size License Plate Nut  
GM

UNIT PACKAGE: 50

**LICENSE PLATE FASTENERS**  
(ILLUSTRATION ACTUAL SIZE)

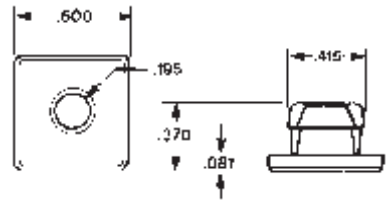

**11719**  
(3907444,  
4755299)  
Nylon

1/4" (#14) Screw Size  
License Plate Nut  
GM

UNIT PACKAGE: 50

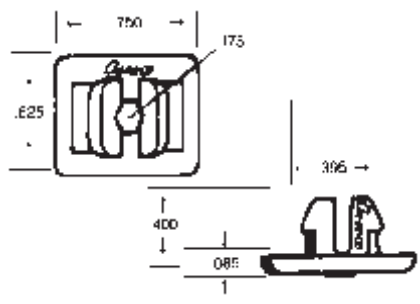

**8418**  
(380370)  
Nylon

#14 Screw Size  
License Plate Nut  
GM  
Use With Auveco Screw 3089

UNIT PACKAGE: 50



**11368**  
(380707-S)  
Nylon

#14 Screw Size  
License Plate Nut  
Ford

UNIT PACKAGE: 50



**8954**  
Nylon

#14 Screw Size  
License Plate Nut  
Use With Auveco Screws  
8249 or 8952

UNIT PACKAGE: 50



**19485**  
(6027958)  
Natural Nylon

1/4" (#14) Screw Size  
License Plate Nut  
Chrysler

UNIT PACKAGE: 10



**19317**  
(15707256)  
Zinc Organic

Front Fender Extension  
& License Plate Bracket  
Retainer Nut  
M6-1.0 Screw Size  
GM Express & Savanna  
1996-On

UNIT PACKAGE: 10

When The World Thinks  
Of Body Hardware &  
Specialty Fasteners Only  
One Name Comes To  
Mind...



# Sec. 6

# CYLINDER HEAD AND MANIFOLD STUDS

Grade 8 Medium Carbon Heat Treated Steel

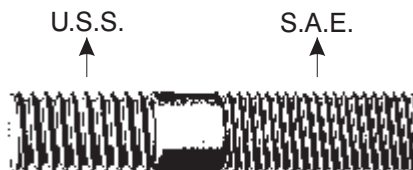
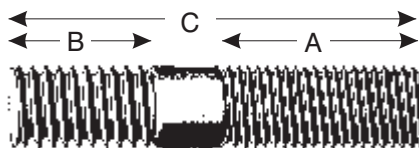

Auveco Part No.	A Dia. & Length	B Dia & Length	C Overall Length	Unit Pkg.
19595 •	1/4"-20 USS x 1/2"	1/4"-20 USS x 8"	.9"	10
9667	1/4"-28 SAE x 3/8"	1/4"-20 USS x 7/16"	.1"	10
9668	1/4"-28 SAE x 1/2"	1/4"-20 USS x 1/2"	1-1/4"	10
9669	1/4"-28 SAE x 3/4"	1/4"-20 USS x 1/2"	1-1/2"	10
9670	1/4"-28 SAE x 1"	1/4"-20 USS x 1/2"	.2"	10
9673	5/16"-24 SAE x 1/2"	5/16"-18 USS x 3/8"	.1"	10
9674	5/16"-24 SAE x 5/8"	5/16"-18 USS x 1/2"	1-1/4"	10
9675	5/16"-24 SAE x 5/8"	5/16"-18 USS x 3/4"	1-1/2"	10
19596	5/16"-24 SAE x 13/16"	5/16"-18 USS x 9/16"	1-1/2"	10
9676	5/16"-24 SAE x 7/8"	5/16"-18 USS x 9/16"	1-3/4"	10
9677	5/16"-24 SAE x 1"	5/16"-18 USS x 9/16"	.2"	10
9678	5/16"-24 SAE x 1/2"	5/16"-18 USS x 1/2"	2-1/2"	10
14824	5/16"-24 SAE x 1-5/8"	5/16"-18 USS x 1/2"	2-1/2"	10
9679	5/16"-18 USS x 7/8"	5/16"-18 USS x 7/16"	1-1/2"	10
9680	5/16"-18 USS x 1"	5/16"-18 USS x 7/16"	.2"	10
9681	5/16"-24 SAE x 1-1/2"	5/16"-18 USS x 5/8"	.3"	10
9683	3/8"-24 SAE x 3/4"	3/8"-16 USS x 1/2"	1-1/2"	10
9684	3/8"-24 SAE x 3/4"	3/8"-16 USS x 1/2"	1-3/4"	10
9685	3/8"-24 SAE x 3/4"	7/16"-14 USS x 7/8"	1-7/8"	10
9686	3/8"-24 SAE x 1"	3/8"-16 USS x 5/8"	.2"	10
9687	3/8"-16 USS x 1-1/8"	3/8"-16 USS x 5/8"	.2"	10
9688	3/8"-16 USS x 1"	3/8"-16 USS x 5/8"	2-1/8"	10
14827*	3/8"-16 USS x 1-5/8"	3/8"-16 USS x 7/16"	2-7/32"	10
19597	3/8"-16 USS x 1/2"	3/8"-16 USS x 1-7/8"	2-1/2"	10
9689	3/8"-24 SAE x 1"	3/8"-16 USS x 3/4"	2-3/4"	10
12129	3/8"-16 USS x 5/8"	3/8"-16 USS x 2"	.3"	10
9690	3/8"-24 SAE x 2"	3/8"-16 USS x 5/8"	.3"	10
9692	3/8"-16 USS x 1-5/8"	3/8"-16 USS x 7/16"	3-1/4"	10
14828*	3/8"-16 USS x 2-3/16"	3/8"-16 USS x 1/2"	3-5/16"	10
9694	3/8"-24 SAE x 1"	3/8"-16 USS x 3/4"	3-3/4"	10
9695	3/8"-16 USS x 2"	3/8"-16 USS x 3/4"	.4"	10
9696	3/8"-24 SAE x 1-7/8"	3/8"-16 USS x 1/2"	.4"	10
9697	7/16"-20 SAE x 3/4"	7/16"-14 USS x 1/2"	1-1/2"	10
9698	7/16"-14 USS x 13/16"	7/16"-14 USS x 3/4"	1-3/4"	10
9699	7/16"-20 SAE x 3/4"	7/16"-14 USS x 9/16"	1-3/4"	10
9701	7/16"-20 SAE x 7/8"	7/16"-14 USS x 3/4"	.2"	10
9702	7/16"-14 USS x 15/16"	7/16"-14 USS x 3/4"	.2"	10
9705	7/16"-20 SAE x 3/4"	7/16"-14 USS x 3/4"	2-1/4"	10
9709	7/16"-20 SAE x 7/8"	7/16"-14 USS x 3/4"	2-1/2"	10
9711	7/16"-14 USS x 1-1/4"	7/16"-14 USS x 1"	2-1/2"	10
9712	7/16"-20 SAE x 1-3/8"	7/16"-14 USS x 3/4"	2-1/2"	10
9715	7/16"-20 SAE x 1-13/16"	7/16"-14 USS x 3/4"	.3"	10
19599	7/16"-20 SAE x 1-7/8"	7/16"-14 USS x 5/8"	3-1/4"	10
19598	7/16"-14 USS x 1-7/8"	7/16"-14 USS x 3/4"	3-1/4"	10
9727	1/2"-20 SAE x 3/4"	1/2"-13 USS x 3/4"	1-7/8"	10
9728	1/2"-20 SAE x 15/16"	1/2"-13 USS x 13/16"	.2"	10
9729	1/2"-20 SAE x 1-1/8"	1/2"-13 USS x 3/4"	2-1/4"	10
9731	1/2"-20 SAE x 1"	1/2"-13 USS x 3/4"	2-1/2"	10
9732	1/2"-20 SAE x 2"	1/2"-13 USS x 3/4"	.3"	10
9738	9/16"-18 SAE x 1"	9/16"-12 USS x 3/4"	2-1/2"	10
9739	9/16"-18 SAE x 1-1/4"	9/16"-12 USS x 1"	.3"	10
9743	5/8"-18 SAE x 1"	5/8"-11 USS x 3/4"	2-1/2"	10
9744	5/8"-11 USS x 1-1/2"	5/8"-11 USS x 13/16"	2-5/8"	10
9745	5/8"-18 SAE x 1-1/4"	5/8"-11 USS x 1"	.3"	10
9746	5/8"-18 SAE x 1-1/2"	5/8"-11 USS x 1-1/4"	3-1/2"	10
9748	3/4"-10 USS x 1-9/16"	3/4"-10 USS x 1-1/16"	2-13/16"	10

•Grade 2, Zinc Plated

\*w/Dog Point





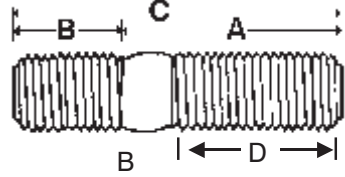

# CYLINDER HEAD AND MANIFOLD METRIC STUDS

## Grade 8 Medium Carbon Heat Treated Steel

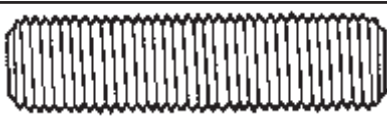

Auveco Part No.	A Diameter & Length	B Diameter & Length	C Overall Length	D Length	Unit Pkg.
11973	6mm-1.00 x 20mm	6mm-1.00 x 7.5mm	27.5mm	18mm	10
11974	6mm-1.00 x 25mm	6mm-1.00 x 7.5mm	32.5mm	18mm	10
11980	8mm-1.25 x 20mm	8mm-1.25 x 10mm	30.0mm	16mm	10
11981	8mm-1.25 x 25mm	8mm-1.25 x 10mm	35.0mm	22mm	10
11982	8mm-1.25 x 30mm	8mm-1.25 x 10mm	40.0mm	22mm	10
11983	8mm-1.25 x 35mm	8mm-1.25 x 10mm	45.0mm	22mm	10
11984	8mm-1.25 x 40mm	8mm-1.25 x 10mm	50.0mm	22mm	10
11987	8mm-1.25 x 55mm	8mm-1.25 x 10mm	65.0mm	22mm	10
11989	10mm-1.50 x 30mm	10mm-1.50 x 12mm	42.0mm	18mm	10
11990	10mm-1.50 x 35mm	10mm-1.50 x 12mm	47.0mm	26mm	10
11991	10mm-1.50 x 40mm	10mm-1.50 x 12mm	52.0mm	26mm	10
11993	10mm-1.50 x 50mm	10mm-1.50 x 12mm	62.0mm	26mm	10
11995	10mm-1.50 x 60mm	10mm-1.50 x 12mm	72.0mm	26mm	5
11998	12mm-1.75 x 30mm	12mm-1.75 x 15mm	45.0mm	25mm	5

 <b>11403</b> (N14-443-4) Plain M8-1.25 x 38mm Volkswagen Exhaust Manifold UNIT PACKAGE: 25	 <b>11404</b> (N14-4003) Plain M8-1.25 x 35mm Volkswagen Intake Manifold UNIT PACKAGE: 25	 <b>18514</b> (21006951) Phosphate M8-1.25 x 50mm Dim A: 17mm Dim B: 20mm Torx® Drive Intake Manifold, GM Saturn UNIT PACKAGE: 25
 <b>17559</b> Zinc & Yellow Dichromate M10-1.25 x 42mm Dim. A: 10mm; Dim. B: 21mm Class 8.8 Exhaust Systems Honda, Nissan & Toyota UNIT PACKAGE: 10	 <b>17560</b> Zinc & Yellow Dichromate M10-1.25 x 48mm Dim. A: 15mm; Dim. B: 25mm Class 8.8 Exhaust Systems Honda, Nissan & Toyota UNIT PACKAGE: 10	 <b>17596</b> Zinc & Yellow Dichromate M12-1.25 x 50mm Class 8.8 Catalytic Converter Mazda UNIT PACKAGE: 5



### Threaded Rod

Zinc Plated

Regular Pitch  
 DIN 975 • Tensile Strength 34,800 PSI

Auveco Part No.	Thread Size	Length	Unit Pkg.
11284	M8-1.25	1 Meter (39")	3
11286	M12-1.75	1 Meter (39")	2

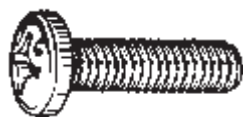

**Phillips Pan Head  
Metric Machine Screws**  
DIN 7985  
Regular Pitch • Zinc Plated

Auveco Part No.	Diameter & Pitch	Length	Unit Pkg.
15867	4mm-.70	8mm	100
15868	4mm-.70	10mm	100
15869	4mm-.70	16mm	100
15870	5mm-.80	8mm	100
15871	5mm-.80	10mm	100
15872	5mm-.80	12mm	100
15873	5mm-.80	16mm	100
15874	5mm-.80	20mm	100
15875	5mm-.80	25mm	100
15876	6mm-1.00	10mm	100
15877	6mm-1.00	12mm	100
15878	6mm-1.00	16mm	50
15879	6mm-1.00	20mm	50
15880	6mm-1.00	25mm	50
15881	6mm-1.00	30mm	50



**Slotted Flat Fillister Head  
Metric Machine Screws**  
DIN 84  
Regular Pitch • Zinc Plated

Auveco Part No.	Diameter & Pitch	Length	Unit Pkg.
10459	5mm-.80	16mm	25
10460	5mm-.80	20mm	25
14396	6mm-1.00	10mm	100
10463	6mm-1.00	16mm	25
14397	6mm-1.00	16mm	100
10464	6mm-1.00	20mm	25
14398	6mm-1.00	20mm	50
14399	6mm-1.00	25mm	50
10466	6mm-1.00	30mm	25
10476	10mm-1.50	35mm	5



**Slotted Pan Head  
Metric Machine Screws**  
DIN 85  
Regular Pitch • Zinc Plated

Auveco Part No.	Diameter & Pitch	Length	Unit Pkg.
10425	4mm-.70	6mm	25
10426	4mm-.70	8mm	25
10427	4mm-.70	10mm	25
10428	4mm-.70	16mm	25
10431	5mm-.80	12mm	25
10432	5mm-.80	16mm	25
10433	5mm-.80	18mm	25
10434	5mm-.80	20mm	25
10436	6mm-1.00	10mm	25
14391	6mm-1.00	10mm	100
10437	6mm-1.00	12mm	25
14392	6mm-1.00	12mm	100
10438	6mm-1.00	16mm	25
14393	6mm-1.00	16mm	100
10439	6mm-1.00	18mm	25
14394	6mm-1.00	18mm	100
10440	6mm-1.00	20mm	25
14395	6mm-1.00	20mm	100
10441	6mm-1.00	25mm	25
10442	6mm-1.00	30mm	25



**Phillips Oval Head  
Metric Machine Screws**  
DIN 966  
Regular Pitch • Zinc Plated

Auveco Part No.	Diameter & Pitch	Length	Unit Pkg.
15888	5mm-.80	12mm	100
15890	5mm-.80	20mm	100
15891	5mm-.80	25mm	50
15892	6mm-1.00	10mm	100
15893	6mm-1.00	12mm	100
15895	6mm-1.00	20mm	50
15896	6mm-1.00	25mm	50

# METRIC ITEMS

## Slotted Flat Head Metric Machine Screws DIN 963 (Medium Head)



Regular Pitch • Zinc Plated

Auveco Part No.	Diameter & Pitch	Length	Unit Pkg.	Auveco Part No.	Diameter & Pitch	Length	Unit Pkg.
10478	4mm-.70	8mm	25	10489	6mm-1.00	30mm	25
10480	4mm-.70	15mm	25	10497	10mm-1.50	25mm	10
10488	6mm-1.00	25mm	25	10498	10mm-1.50	30mm	10



## DIN 931 & DIN 933 Regular Pitch Metric Hex Head Cap Screws

Fully Threaded • Zinc Plated • 8.8 Heat Treated Alloy Steel  
Tensile Strength: 116,000 PSI

Auveco Part No.	Diameter & Pitch	Length	Unit Pkg.	Auveco Part No.	Diameter & Pitch	Length	Unit Pkg.
4mm (7mm Hex)				16699	6mm-1.00	20mm	100
14581	4mm-.7	12mm	50	10512	6mm-1.00	25mm	10
10501	4mm-.7	16mm	25	14410	6mm-1.00	25mm	25
14400	4mm-.7	16mm	50	16700	6mm-1.00	25mm	100
10502	4mm-.7	20mm	25	10513	6mm-1.00	30mm	10
14401	4mm-.7	20mm	50	14411*	6mm-1.00	30mm	25
14582	4mm-.7	25mm	50	16701*	6mm-1.00	30mm	100
5mm (8mm Hex)				10514*	6mm-1.00	35mm	10
10504	5mm-.8	10mm	25	14412*	6mm-1.00	35mm	25
14402	5mm-.8	10mm	50	10515*	6mm-1.00	40mm	10
14583	5mm-.8	12mm	50	14413*	6mm-1.00	40mm	25
10505	5mm-.8	16mm	25	10516*	6mm-1.00	45mm	10
14403	5mm-.8	16mm	50	14414*	6mm-1.00	45mm	25
10506	5mm-.8	20mm	25	14585*	6mm-1.00	50mm	25
14404	5mm-.8	20mm	50	15514*	6mm-1.00	60mm	25
10507	5mm-.8	25mm	25	7mm(11mm Hex)			
14405	5mm-.8	25mm	50	14586	7mm-1.00	12mm	25
10508	5mm-.8	30mm	10	10517	7mm-1.00	16mm	10
14406	5mm-.8	30mm	25	14415	7mm-1.00	16mm	25
15512	5mm-.8	40mm	50	10519	7mm-1.00	25mm	10
6mm (10mm Hex)				14417	7mm-1.00	25mm	25
14584	6mm-1.00	10mm	50	10520	7mm-1.00	30mm	10
10509	6mm-1.00	12mm	25	14418	7mm-1.00	30mm	25
14407	6mm-1.00	12mm	50	14587	7mm-1.00	40mm	25
16697	6mm-1.00	12mm	100	8mm (13mm Hex)			
10510	6mm-1.00	16mm	10	14588	8mm-1.25	12mm	25
14408	6mm-1.00	16mm	25	10521	8mm-1.25	16mm	10
16698	6mm-1.00	16mm	100	14419	8mm-1.25	16mm	25
10511	6mm-1.00	20mm	10	16702	8mm-1.25	16mm	50
14409	6mm-1.00	20mm	25	10522	8mm-1.25	20mm	10
				14420	8mm-1.25	20mm	25
				16703	8mm-1.25	20mm	50

(Continued on next page)

# Sec. 7

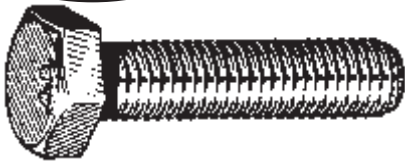

## METRIC ITEMS

\*DIN 931 - Not Fully Threaded  
DIN 931 & DIN 933

### Regular Pitch Metric Hex Head Cap Screws

Fully Threaded • Zinc Plated • 8.8 Heat Treated Alloy Steel  
Tensile Strength: 116,000 PSI

Auveco Part No.	Diameter & Pitch	Length	Unit Pkg.	Auveco Part No.	Diameter & Pitch	Length	Unit Pkg.
8mm (13mm Hex) Continued							
10523	8mm-1.25	25mm	10	10541*	10mm-1.50	55mm	5
14421	8mm-1.25	25mm	25	14437*	10mm-1.50	55mm	10
16704	8mm-1.25	25mm	50	10542*	10mm-1.50	60mm	5
10524	8mm-1.25	30mm	10	14438*	10mm-1.50	60mm	10
14422	8mm-1.25	30mm	25	16714*	10mm-1.50	60mm	25
16705	8mm-1.25	30mm	50	10543*	10mm-1.50	70mm	5
10525*	8mm-1.25	35mm	10	14439*	10mm-1.50	70mm	10
14423*	8mm-1.25	35mm	25	15515*	10mm-1.50	80mm	10
16706*	8mm-1.25	35mm	50	15516*	10mm-1.50	90mm	10
10526*	8mm-1.25	40mm	10	15517*	10mm-1.50	100mm	10
14424*	8mm-1.25	40mm	25	12mm (19mm Hex)			
16707*	8mm-1.25	40mm	50	10544	12mm-1.75	25mm	5
10527*	8mm-1.25	45mm	10	14440	12mm-1.75	25mm	10
14425*	8mm-1.25	45mm	25	16715	12mm-1.75	25mm	25
10528*	8mm-1.25	50mm	10	10545	12mm-1.75	30mm	5
14426*	8mm-1.25	50mm	25	14441	12mm-1.75	30mm	10
10529*	8mm-1.25	55mm	10	16716	12mm-1.75	30mm	25
14427*	8mm-1.25	55mm	25	10546	12mm-1.75	35mm	5
10530*	8mm-1.25	60mm	10	14442	12mm-1.75	35mm	10
14428*	8mm-1.25	60mm	25	16717	12mm-1.75	35mm	25
10531*	8mm-1.25	65mm	5	10547	12mm-1.75	40mm	5
10532	8mm-1.25	70mm	5	14443	12mm-1.75	40mm	10
14429	8mm-1.25	70mm	10	16718	12mm-1.75	40mm	25
14589*	8mm-1.25	75mm	10	10548*	12mm-1.75	45mm	5
17399*	8mm-1.25	80mm	15	14444*	12mm-1.75	45mm	10
17400*	8mm-1.25	90mm	15	10549*	12mm-1.75	50mm	5
17401*	8mm-1.25	100mm	10	14445*	12mm-1.75	50mm	10
10mm (17mm Hex)				10550*	12mm-1.75	60mm	5
10534	10mm-1.50	20mm	10	14446*	12mm-1.75	60mm	10
14430	10mm-1.50	20mm	25	10551*	12mm-1.75	70mm	5
16708	10mm-1.50	20mm	50	14447*	12mm-1.75	70mm	10
10535	10mm-1.50	25mm	10	17403*	12mm-1.75	80mm	10
14431	10mm-1.50	25mm	25	17404*	12mm-1.75	90mm	10
16709	10mm-1.50	25mm	50	17405*	12mm-1.75	100mm	5
10536	10mm-1.50	30mm	10	14mm (22mm Hex)			
14432	10mm-1.50	30mm	25	14590	14mm-2.0	30mm	10
16710	10mm-1.50	30mm	50	14591	14mm-2.0	40mm	10
10537	10mm-1.50	35mm	5	14592	14mm-2.0	50mm	10
14433	10mm-1.50	35mm	15	14593*	14mm-2.0	60mm	10
16711	10mm-1.50	35mm	25	14594*	14mm-2.0	70mm	10
10538*	10mm-1.50	40mm	5	16mm (24mm Hex)			
14434*	10mm-1.50	40mm	15	14595	16mm-2.0	30mm	5
16712*	10mm-1.50	40mm	25	14596	16mm-2.0	40mm	5
10539*	10mm-1.50	45mm	5	14598*	16mm-2.0	60mm	5
14435*	10mm-1.50	45mm	15	20mm (30mm Hex)			
10540*	10mm-1.50	50mm	5	14601	20mm-2.5	50mm	5
14436*	10mm-1.50	50mm	15	14602	20mm-2.5	60mm	5
16713*	10mm-1.50	50mm	25				

\*DIN 931 - Not Fully Threaded

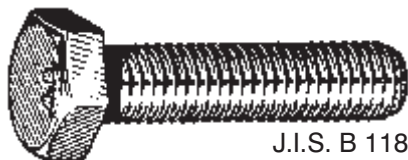

## J.I.S. Small Head Cap Screws

J.I.S. B 1180 • Steel • Heat Treated • I.S.O. Class 8.8 • Zinc Plated

J.I.S. fasteners have a smaller hex dimension (across the flats) than DIN or ISO metric fasteners. They fit in those tight spots where the hex of an ISO or DIN fastener is too large. J.I.S. fasteners are OEM equipment on many GM and Japanese import car applications.

Auveco Part No.	Diameter & Pitch	Length	Unit Pkg.
M8-1.25 (12mm Hex)			
<b>14777</b>	8mm-1.25	16mm	25
<b>14778</b>	8mm-1.25	20mm	25
<b>14779</b>	8mm-1.25	25mm	25
<b>14780</b>	8mm-1.25	30mm	25
<b>14781</b>	8mm-1.25	35mm	25
<b>14782</b>	8mm-1.25	40mm	25
<b>14784</b>	8mm-1.25	50mm	25
M10-1.25 (14mm Hex)			
<b>14787</b>	10mm-1.25	20mm	25
<b>14788</b>	10mm-1.25	25mm	25
<b>14789</b>	10mm-1.25	30mm	25
<b>14790</b>	10mm-1.25	35mm	15

Auveco Part No.	Diameter & Pitch	Length	Unit Pkg.
<b>14791</b>	10mm-1.25	40mm	15
<b>14792</b>	10mm-1.25	45mm	15
<b>14793</b>	10mm-1.25	50mm	15
<b>14794</b>	10mm-1.25	60mm	10
<b>14795</b>	10mm-1.25	70mm	10
M12-1.25 (17mm Hex)			
<b>16609</b>	12mm-1.25	20mm	10
<b>16610</b>	12mm-1.25	25mm	10
<b>16611</b>	12mm-1.25	30mm	10
<b>16612</b>	12mm-1.25	35mm	10
<b>16613</b>	12mm-1.25	40mm	10
<b>16614</b>	12mm-1.25	50mm	10



## DIN 960 & DIN 961

Fine Pitch Metric Hex Head Cap Screws  
Fully Threaded • 8.8 Heat Treated Alloy Steel • Black Finish  
Tensile Strength: 116,000 PSI

Auveco Part No.	Diameter & Pitch	Length	Unit Pkg.
8mm (13mm Hex)			
<b>11255</b>	8mm-1.00	10mm	10
<b>11256</b>	8mm-1.00	20mm	10
<b>11257</b>	8mm-1.00	25mm	10
<b>11258</b>	8mm-1.00	35mm	10
<b>11259</b>	8mm-1.00	40mm	10
<b>14604*</b>	8mm-1.00	50mm	25
10mm (17mm Hex)			
<b>11260</b>	10mm-1.00	20mm	10
<b>11261</b>	10mm-1.00	25mm	10
<b>11262</b>	10mm-1.00	30mm	10
<b>11263</b>	10mm-1.00	40mm	10
<b>11264</b>	10mm-1.00	50mm	10
<b>14605</b>	10mm-1.25	20mm	10
<b>11265</b>	10mm-1.25	25mm	10
<b>11266</b>	10mm-1.25	30mm	10
<b>11267</b>	10mm-1.25	35mm	10
<b>11268</b>	10mm-1.25	40mm	10
<b>11269</b>	10mm-1.25	50mm	10
<b>14606*</b>	10mm-1.25	60mm	10

Auveco Part No.	Diameter & Pitch	Length	Unit Pkg.
12mm (19mm Hex)			
<b>11270</b>	12mm-1.25	25mm	10
<b>14607</b>	12mm-1.25	30mm	5
<b>11271</b>	12mm-1.25	35mm	5
<b>14608</b>	12mm-1.25	40mm	5
<b>11272</b>	12mm-1.25	50mm	5
<b>14609*</b>	12mm-1.25	60mm	5
<b>14610*</b>	12mm-1.25	70mm	5
<b>11273</b>	12mm-1.50	20mm	10
<b>11274</b>	12mm-1.50	30mm	10
<b>11275</b>	12mm-1.50	40mm	5
<b>11276</b>	12mm-1.50	50mm	5
14mm (22mm Hex)			
<b>14611</b>	14mm-1.50	30mm	5
<b>14612</b>	14mm-1.50	40mm	5
<b>14613</b>	14mm-1.50	50mm	5
<b>14614*</b>	14mm-1.50	60mm	5
16mm (24mm Hex)			
<b>14616</b>	16mm-1.50	30mm	5
<b>14617</b>	16mm-1.50	40mm	5
<b>14618</b>	16mm-1.50	50mm	5

\*DIN 960 - Not Fully Threaded



**Metric Hex Socket Head Cap Screws**

DIN 912

Regular Pitch - Grade 12.9  
Heat Treated Alloy Steel • Plain Finish  
Tensile Strength: 177,000 PSI



**Metric Low Socket Head Cap Screws**

DIN 6912

Regular Pitch - Grade 8.8  
Heat Treated Alloy Steel • Plain Finish  
Tensile Strength: 116,000 PSI

Auveco Part No.		Diameter & Pitch	Length
Unit Package			
10	100		
<b>10845</b>	<b>10872</b>	4mm-.7	12mm
<b>10846</b>	<b>10873</b>	5mm-.8	12mm
<b>10847</b>	.....	5mm-.8	16mm
<b>10848</b>	<b>10875</b>	5mm-.8	20mm
<b>10851</b>	<b>10878</b>	6mm-1.00	16mm
<b>10853</b>	.....	6mm-1.00	25mm
<b>10854</b>	.....	6mm-1.00	30mm
<b>10855</b>	.....	8mm-1.25	16mm
<b>10857</b>	.....	8mm-1.25	25mm
<b>10858</b>	<b>10885</b>	8mm-1.25	30mm
<b>10859</b>	.....	8mm-1.25	35mm
<b>10860</b>	.....	8mm-1.25	40mm
<b>10861</b>	.....	10mm-1.50	20mm
<b>10862</b>	.....	10mm-1.50	25mm
<b>10863</b>	.....	10mm-1.50	30mm
<b>10864</b>	.....	10mm-1.50	40mm
<b>10865</b>	.....	10mm-1.50	50mm
<b>10866</b>	.....	12mm-1.75	30mm
<b>10867</b>	.....	12mm-1.75	35mm
<b>10868</b>	.....	12mm-1.75	40mm
<b>10870</b>	.....	12mm-1.75	60mm

Auveco Part No.	Unit Pkg.	Diameter & Pitch	Length
<b>10898</b>	10	5mm-.8	10mm
<b>10908</b>	10	8mm-1.25	20mm

**All items available in bulk.**



**Metric Flat Head Socket Cap Screws**

DIN 7991

Regular Pitch - Grade 10.9  
Heat Treated Alloy Steel • Plain Finish • Tensile Strength: 150,800 PSI

Auveco Part No.		Diameter & Pitch	Length
Unit Package			
10	100		
<b>10958</b>	.....	6mm-1.00	10mm
<b>10960</b>	<b>10961</b>	6mm-1.00	16mm
<b>10966</b>	.....	6mm-1.00	30mm

Auveco Part No.	Unit Package	Diameter & Pitch	Length
<b>10970</b>	10	8mm-1.25	20mm
<b>10972</b>	10	8mm-1.25	25mm



## Metric Socket Set Screws - Cup Point

DIN 916  
Regular Pitch - Grade 12.9  
Heat Treated Alloy Steel  
Plain Finish

Auveco Part No.		Diameter & Pitch	Length
Unit Package			
10	100		
<b>10996</b>	.....	4mm-.7	8mm
<b>11004</b>	.....	5mm-.8	8mm
<b>11006</b>	.....	5mm-.8	10mm
<b>11008</b>	.....	5mm-.8	16mm
<b>11010</b>	.....	6mm-1.00	8mm
<b>11012</b>	<b>11013</b>	6mm-1.00	10mm

Auveco Part No.		Diameter & Pitch	Length
Unit Package			
10	100		
<b>11022</b>	.....	8mm-1.25	16mm
<b>11024</b>	.....	8mm-1.25	20mm
<b>11032</b>	.....	10mm-1.50	20mm
<b>11039</b>	<b>11040</b>	10mm-1.50	40mm

## Metric Hex Keys Plain Finish



Use With Din 912 & Din 7991



Use With Din 6912

Auveco Part No.	Hex Size	For Screw Size	Unit Pkg.
<b>7965</b> .....	3mm .....	4mm .....	10
<b>7969</b> .....	8mm .....	10mm .....	10

Auveco Part No.	Hex Size	For Screw Size	Unit Pkg.
<b>7975</b> .....	10mm .....	12mm .....	10



**The World's Largest Supplier Of  
Body Hardware & Specialty Fasteners  
To The Collision Repair Professional**

**Sec. 7**

**METRIC ITEMS**

**Hex Head Sems® Split Wave Washer Body Bolts For Import Cars**

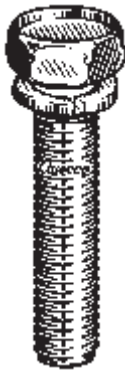

Class 9.8 • Zinc & Yellow Dichromate Plated

Auveco Part No.	Size	Hex Size	Washer O.D.	Unit Pkg.
16750	M6-1.0 x 25mm	10mm	11mm	25
16751	M6-1.0 x 30mm	10mm	11mm	25
16753	M8-1.25 x 25mm	13mm	14mm	25
16754	M8-1.25 x 30mm	13mm	14mm	25
16755	M8-1.25 x 40mm	13mm	14mm	25

**Hex Head Sems® Split Wave Washer Body Bolts With Flat Washers**

(Flat Washer is packed loose in box)

For Import Cars

Class 9.8 • Zinc & Yellow Dichromate Plated

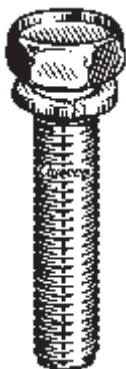

Auveco Part No.	Size	Hex Size	Wave Washer O.D.	Flat Washer O.D.	Unit Pkg.
16757	M6-1.0 x 25mm	10mm	11mm	12mm	25
16758	M6-1.0 x 30mm	10mm	11mm	12mm	25
16760	M8-1.25 x 25mm	13mm	14mm	17mm	25
16761	M8-1.25 x 30mm	13mm	14mm	17mm	25
16762	M8-1.25 x 40mm	13mm	14mm	17mm	25



**Hex Head Sems® Body Bolts**

For Import Cars

Class 8.8 • Zinc & Yellow Dichromate Plated

Auveco Part No.	Size	Hex Size	Washer O.D.	Unit Pkg.
20434	M6-1.0 x 12mm	10mm	12.5mm	50
18177	M6-1.0 x 16mm	10mm	12.5mm	50
20435	M6-1.0 x 20mm	10mm	12.5mm	50
18180	M6-1.0 x 30mm	10mm	12.5mm	50
18181	M6-1.0 x 35mm	10mm	12.5mm	25
18182	M8-1.25 x 20mm	12mm	17mm	25
18184	M8-1.25 x 30mm	12mm	17mm	25
18185	M8-1.25 x 35mm	12mm	17mm	25
18187	M8-1.25 x 45mm	12mm	17mm	25



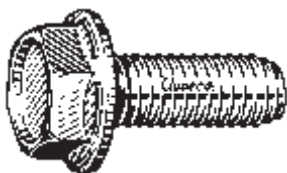

## Metric Hex Flange Serrated Bolts



Serrations Under The Head  
Class 10.9 (Property Class 90)  
Black Phosphate

Auveco Part No.	Size	Hex	Unit Pkg.
16793	M6-1.0 x 16mm	10mm	25
16794	M6-1.0 x 20mm	10mm	25
16795	M8-1.25 x 16mm	13mm	25
16796	M8-1.25 x 20mm	13mm	25
16797	M8-1.25 x 25mm	13mm	25

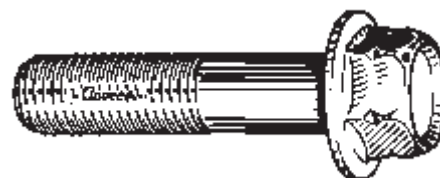
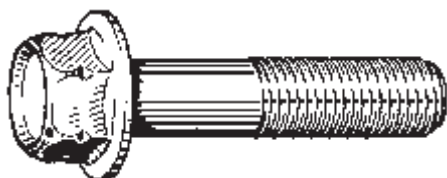

## J.I.S. Small Head Hex Flange Bolts

J.I.S. B1189 • I.S.O. Class 10.9 • Zinc Plated

10mm Bolts Are Used With Auveco Hex Flange Nut 16470 On Import Car Exhaust Systems

Auveco Part No.	Size	Hex Size	Flange O.D.	Unit Pkg.
17315	M6-1.0 x 12mm	10mm	14mm	50
17316	M6-1.0 x 16mm	10mm	14mm	50
18807	M6-1.0 x 20mm	10mm	14mm	50
18808	M6-1.0 x 30mm	10mm	14mm	25
18809	M6-1.0 x 40mm	10mm	14mm	25
18980	M8-1.25 x 12mm	12mm	17.5mm	25
17387	M8-1.25 x 16mm	12mm	17.5mm	15
17388	M8-1.25 x 20mm	12mm	17.5mm	15
17389	M8-1.25 x 30mm	12mm	17.5mm	15
17390	M8-1.25 x 40mm	12mm	17.5mm	15
17188	M10-1.25 x 16mm	14mm	20mm	10
17189	M10-1.25 x 20mm	14mm	20mm	10
17190	M10-1.25 x 30mm	14mm	20mm	10
17191	M10-1.25 x 40mm	14mm	20mm	10



## Torx® Round Washer Head Body Bolts

CA Point • Plated



Auveco Part No.	Size	Finish	Washer Head Dia.	Torx® Drive	Unit Pkg.
15807	M6-1.0 x 25mm	Zinc	18mm	T-30	50



**Metric Hex Head Sems® Bolts - Type CA**

Auveco Part No.	Size	Washer O.D.	Hex Size	Finish	Unit Pkg.
12693	M6-1.00 .x 20mm	17mm	10mm	Phos.	25
13617	M6-1.00 .x 20mm	24mm	10mm	Phos.	50
12065	M6-1.00 .x 25mm	17mm	10mm	Phos.	50
12066	M6-1.00 .x 25mm	24mm	10mm	Phos.	50
12323	M6-1.00 .x 25mm	24mm	10mm	Bk. Polyseal	25
13618	M6-1.00 .x 30mm	24mm	10mm	Phos.	50
11633	M6.3-1.00 .x 20mm	17mm	10mm	Phos.	25
11935	M6.3-1.00 .x 25mm	17mm	10mm	Zinc	25
13704	M8-1.25 .x 20mm	24mm	13mm	Phos.	25
13613	M8-1.25 .x 25mm	24mm	13mm	Phos.	25
13614	M8-1.25 .x 30mm	24mm	13mm	Phos.	25
13705	M8-1.25 .x 35mm	24mm	13mm	Phos.	25
13619	M10-1.50 .x 30mm	30mm	15mm	Phos.	10
11641	M10-1.50 .x 40mm	28mm	15mm	Phos.	25
13620	M10-1.50 .x 45mm	30mm	15mm	Phos.	10



**12232**  
(6100539)  
Phosphate

M5-0.8 x 20mm  
Hex Head Sems®  
Thread Cutting Screw  
With Dog Point  
12mm (1/2") O.D. Washer  
8mm Hex  
Chrysler

UNIT PACKAGE: 50



**18382**  
(W700548S300)  
Black Nylon

M5 x 24mm  
Phillips Pan Washer Head  
Attachment Of Scuff Plate  
To Body Lower Back Panel  
Contour & Mystique  
1995-On

UNIT PACKAGE: 50

# METRIC ITEMS

# Sec. 7



**12341**  
(N605771-S2)  
Phosphate  
M6-1.0 x 14mm  
Hex Washer Head  
Class 9.8; 8mm Hex  
13mm (1/2") Wshr Hd. O.D.  
Ford  
UNIT PACKAGE: 50

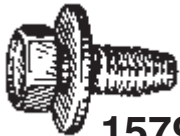

**15791**  
(11508930)  
Black  
Fluorocarbon  
M6-1.0 x 16mm  
Hex Head Sems®  
Class 9.8; 10mm Hex  
17mm (21/32") Wshr O.D.  
GM  
UNIT PACKAGE: 50



**12064**  
(11503812)  
Zinc & Yellow  
M6-1.0 x 16mm  
Hex Head Sems®  
Class 9.8; 10mm Hex  
18.5mm (47/64") Wshr O.D.  
GM  
UNIT PACKAGE: 50

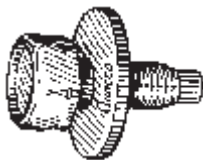

**20176**  
(N800510-S100)  
Phosphate  
M6-1.0 x 18.5mm  
Hex Head Sems  
With Dog Point  
Class 9.8  
19mm (3/4") Washer O.D.  
11mm Hex  
Replaces Auveco 15719  
Ford  
UNIT PACKAGE: 50



**18515**  
(21094240)  
Black  
500 Hr. Salt Spray  
M6-1.0 x 20mm  
Torx® Washer Head  
With Dog Point & Sealant  
On Threads  
13.5 Washer Head O.D.  
T-30 Drive  
Front & Rear Door Lock  
GM Saturn  
UNIT PACKAGE: 25



**12324**  
(11503800)  
Black Polyseal  
M6-1.0 x 20mm  
Hex Washer Head  
Class 9.8  
13mm (1/2") Wshr Hd. O.D.  
10mm Hex  
GM  
UNIT PACKAGE: 50



**16826**  
(Chry: 34201287;  
AMC: 8934201287)  
Zinc  
M6-1.0 x 20mm  
Slotted Hex Washer Head  
License Plate Screw  
13mm (1/2") Wshr Hd. O.D.  
10mm Hex  
Chrysler, Honda & AMC  
UNIT PACKAGE: 50



**12322**  
(11503815, 11508023)  
Phosphate  
M6-1.0 x 20mm  
Hex Head Sems®  
Class 9.8  
17mm (21/32") Wshr O.D.  
10mm Hex  
GM  
UNIT PACKAGE: 25



**12693**  
(11502941, 11506174)  
Phosphate  
M6-1.0 x 20mm  
Hex Head Sems®  
Class 9.8  
17mm (21/32")  
Washer O.D.  
10mm Hex  
GM  
UNIT PACKAGE: 25



**12067**  
(11504570, 11509816,  
11514623)  
Phosphate  
M6-1.0 x 20mm  
Hex Head Sems®  
Class 9.8; 10mm Hex  
17mm (21/32") Wshr O.D.  
GM  
UNIT PACKAGE: 50



**13617**  
Phosphate  
M6-1.0 x 20mm  
Hex Head Sems®  
Class 9.8; 10mm Hex  
24mm (15/16") Wshr O.D.  
UNIT PACKAGE: 50



**15778**  
(N606676-S36)  
Zinc & Yellow Dichromate  
M6-1.0 x 22.5mm  
Hex Head Sems®  
With Dog Point  
Class 9.8  
19mm (3/4") Washer O.D.  
8mm Hex  
Ford  
UNIT PACKAGE: 50



**12160**  
(N-606676-S2, S100)  
Phosphate  
M6-1.0 x 22mm  
High Hex Head Sems®  
With Dog Point  
Class 9.8; 8mm Hex  
19mm (3/4") Washer O.D.  
Ford  
UNIT PACKAGE: 25



**13715**  
(11503958)  
Phosphate  
M6-1.0 x 25mm  
Hex Washer Head  
Class 9.8; 10mm Hex  
13mm (1/2")  
Washer Hd. O.D.  
GM  
UNIT PACKAGE: 50



**19101**  
(21075387)  
Black Organic  
M6-1.0 x 25mm  
Torx® Button Head  
18mm Washer O.D.  
T-30 Drive  
Fender To Upper Engine  
Rail  
GM Saturn 1991-On  
UNIT PACKAGE: 15



**12338**  
(N605774-S2)  
Phosphate  
M6-1.0 x 25mm  
Hex Washer Head  
Class 9.8  
13mm (1/2")  
Washer Hd. O.D.  
8mm Hex  
Ford  
UNIT PACKAGE: 50

**Sec. 7****METRIC ITEMS****12065**(11503834,  
20351035)  
PhosphateM6-1.0 x 25mm  
Hex Head Sems®  
Class 9.8; 10mm Hex  
17mm (21/32") Wshr O.D.  
GM

UNIT PACKAGE: 50

**12066**(11503982)  
PhosphateM6-1.0 x 25mm  
Hex Head Sems®  
Class 9.8; 10mm Hex  
24mm (15/16") Wshr O.D.  
GM

UNIT PACKAGE: 50

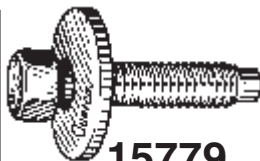
**15779**(N606677-S43B)  
Black Zinc PhosphateM6-1.0 x 28mm  
Hex Hd Sems® w/ Dog Pt  
19mm (3/4") Washer O.D.  
8mm Hex  
Ford

UNIT PACKAGE: 50

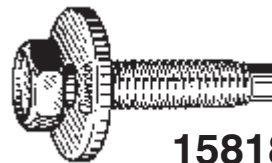
**15818**(6100568)  
PhosphateM6-1.0 x 30mm  
Hex Head Sems®  
With Dog Point  
Class 9.8; 10mm Hex  
19mm (3/4") Washer O.D.  
Chrysler

UNIT PACKAGE: 50

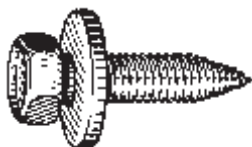
**15788**(11503833)  
ZincM6-1.0 x 25mm  
Hex Head Sems®  
17mm (21/32") Wshr O.D.  
10mm Hex  
GM

UNIT PACKAGE: 50

**12323**(11504493)  
Black PolysealM6-1.0 x 25mm  
Hex Head Sems®  
Class 9.8; 10mm Hex  
24mm (15/16") Wshr O.D.  
GM

UNIT PACKAGE: 25

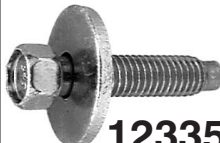
**12335**(N606677-S36)  
Zinc & YellowM6-1.0 x 28mm  
Hex Hd Sems® w/ Dog Pt  
Class 9.8; 8mm Hex  
19mm (3/4") Washer O.D.  
Ford

UNIT PACKAGE: 25

**20261**(10287379)  
PhosphateM6-1.0 x 30mm  
Hex Head Sems®  
Class 9.8; 10mm Hex  
20mm (13/16")  
Washer O.D.  
GM

UNIT PACKAGE: 25

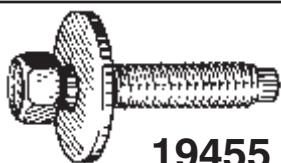
**19455**(6100567)  
PhosphateM6-1.0 x 25mm  
Hex Head Sems®  
w/ Dog Point  
10mm Hex  
19mm (3/4") Washer O.D.  
Grille, Fender,  
Hood Prop & Latch  
Chrysler

UNIT PACKAGE: 25

**14947**(N800928-S45,  
N806345-S47, -S433  
N801851-S45)  
ChromeM6-1.0 x 26mm  
Pan Head Internal  
Torx® Drive Sems®  
14mm Head Diameter  
13mm (1/2") Washer O.D.  
T-30 Drive  
Truck Mirror Mounting  
Bracket Bolt  
Ford Trucks

UNIT PACKAGE: 25

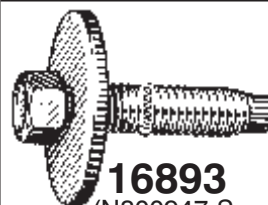
**16893**(N800947-S,  
AB-181-GG)  
PhosphateM6-1.0 x 28mm  
Hex Head Sems®  
With Dog Point  
Class 9.8  
25mm (1") Washer O.D.  
8mm Hex  
Ford

UNIT PACKAGE: 25

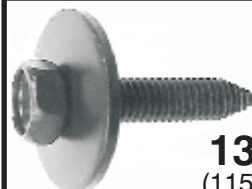
**13618**(11503825)  
PhosphateM6-1.0 x 30mm  
Hex Head Sems®  
Class 9.8; 10mm Hex  
24mm (15/16")  
Washer O.D.  
GM

UNIT PACKAGE: 50

Remember...  
All Items Are  
Available In Bulk.

Call For A Quote.

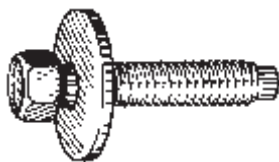
**15757**

Phosphate

M6-1.0 x 27mm  
Hex Hd Sems® w/ Dog Pt  
Class 9.8; 8mm Hex  
19mm (3/4") Washer O.D.

UNIT PACKAGE: 50

**12345**(11503792)  
PhosphateM6-1.0 x 30mm  
Hex Washer Head  
Class 9.8  
13mm (1/2)  
Washer Hd. O.D.  
10mm Hex  
GM

UNIT PACKAGE: 50

**18416**(11505044)  
Black PhosphateM6-1.0 x 35mm  
Hex Head Sems®  
Class 9.8  
17mm (21/32")  
Washer O.D.  
10mm Hex  
GM

UNIT PACKAGE: 50

# METRIC ITEMS

## Sec. 7

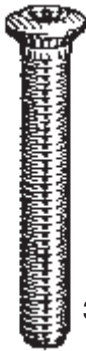

**17125**  
(12338094)  
Black Oxide

M6-1.0 x 45mm  
Oval Head Internal  
Torx® Drive  
302 Stainless Steel  
10mm (3/8")  
Head Dia.  
T-25 Drive  
Luggage Rack  
Attachment  
GM Cars & Vans

UNIT PACKAGE: 25

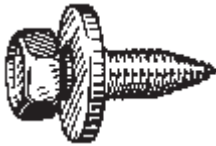

**11633**  
(11501105)  
Phosphate

M6.3-1.0 x 20mm  
Hex Head Sems®  
Class 9.8; 10mm Hex  
17mm (21/32")  
Wshr O.D.  
GM

UNIT PACKAGE: 25

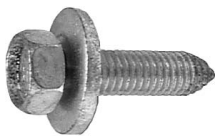

**11935**  
(11502790)  
Zinc

M6.3-1.0 x 25mm  
Hex Head Sems®  
Class 9.8; 10mm Hex  
17mm (21/32") Wshr O.D.  
GM

UNIT PACKAGE: 25



**11638**  
(362029,11509589)  
Phosphate

M8-1.25 x 16mm  
Hex Washer Head  
w/ Serrations Under The  
Head & Dog Point  
18mm (23/32")  
Washer Hd. O.D.  
13mm Hex  
GM

UNIT PACKAGE: 25

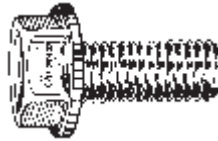

**12692**  
(14060613,  
11502693)  
Zinc Organic

M8-1.25 x 20mm  
Hex Washer Head  
Class 9.8; 13mm Hex  
17mm (21/32")  
Washer Head O.D.  
GM

UNIT PACKAGE: 25



**13704**  
Phosphate

M8-1.25 x 20mm  
Hex Head Sems®  
Class 9.8; 13mm Hex  
24mm (15/16") Wshr O.D.

UNIT PACKAGE: 25

Visit The  

Web Site At

[www.auveco.com](http://www.auveco.com)



**20414**  
(15731424)  
Black Zinc

M8-1.25 x 22mm  
Hex Washer Head  
Shoulder Bolt  
13mm Hex  
18mm (23/32")  
Washer Hd. O.D.  
12.5mm (1/2")  
Shoulder O.D.  
Shoulder Length: 4mm  
Hood Hinge Bolt  
GM C & K Trucks  
1988 - On

UNIT PACKAGE: 25



**11639**  
(11502605,  
11502624, 11509511)  
Phosphate

M8-1.25 x 25mm  
Hex Washer Head  
Class 9.8; 13mm Hex  
17mm (21/32")  
Wshr Hd OD  
GM

UNIT PACKAGE: 25

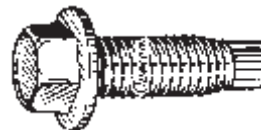

**16361**  
(N801078-S58)  
Phosphate

M8-1.25 x 25mm  
Hex Washer Head  
With Dog Point  
15mm (19/32")  
Washer Head O.D.  
10mm Hex  
Ford

UNIT PACKAGE: 50

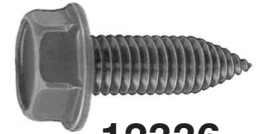

**12336**  
(11503632)  
Black Polyseal

M8-1.25 x 25mm  
Hex Washer Head  
Class 9.8; 13mm Hex  
17mm (21/32")  
Washer Head O.D.  
GM

UNIT PACKAGE: 25

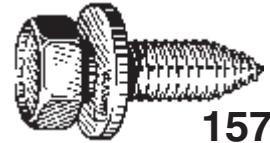

**15790**  
(11505326)  
Phosphate

M8-1.25 x 25mm  
Hex Head Sems®  
Class 9.8; 13mm Hex  
17mm (21/32")  
Wshr O.D.  
GM

UNIT PACKAGE: 50



**13613**  
(11503619)  
Phosphate

M8-1.25 x 25mm  
Hex Head Sems®  
Class 9.8; 13mm Hex  
24mm (15/16") Wshr O.D.  
GM

UNIT PACKAGE: 25



**12333**  
(20059774)  
Phosphate

M8-1.25 x 27mm  
Hex Washer Head  
With Dog Point  
Class 9.8; 11mm Hex  
17mm (21/32")  
Washer Hd. O.D.  
GM

UNIT PACKAGE: 25

**Sec. 7**

**METRIC ITEMS**



**12348**  
(11500971)  
Phosphate

M8-1.25 x 30mm  
Hex Washer Head  
Class 9.8; 13mm Hex  
17mm (21/32")  
Washer Head O.D.  
GM

UNIT PACKAGE: 25



**12343**  
(11504982)  
Phosphate

M8-1.25 x 35mm  
Hex Washer Head  
Class 9.8; 13mm Hex  
17mm (21/32")  
Washer Hd. O.D.  
GM

UNIT PACKAGE: 25



**12329**  
(N605800-S2)  
Phosphate

M10-1.50 x 25mm  
Hex Washer Head  
Class 9.8; 13mm Hex  
20mm (13/16")  
Washer Head O.D.  
Ford

UNIT PACKAGE: 25



**12327**  
(N605920-S2)  
Phosphate

M10-1.50 x 33mm  
Hex Washer Head  
With Dog Point  
Class 9.8; 13mm Hex  
20mm (13/16")  
Washer Hd. O.D.  
Ford

UNIT PACKAGE: 25



**11640**  
(549790, 11500971)  
Zinc Organic

M8-1.25 x 30mm  
Hex Washer Head  
Class 9.8; 13mm Hex  
17mm (21/32")  
Washer Hd. O.D.  
GM

UNIT PACKAGE: 25

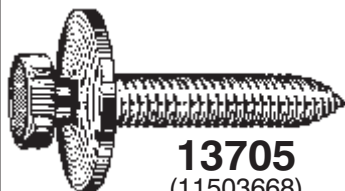

**13705**  
(11503668)  
Phosphate

M8-1.25 x 35mm  
Hex Head Sems®  
Class 9.8; 13mm Hex  
24mm (15/16")  
Washer O.D.  
GM

UNIT PACKAGE: 25



**20436**  
(6507219-AA)  
Zinc Organic

M10-1.5 x 30mm  
Hex Washer Head  
With Dog Point  
24mm Washer Head O.D.  
15mm Hex  
Dodge Truck  
2000 - On

UNIT PACKAGE: 25

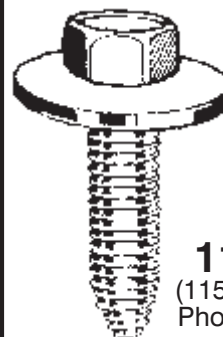

**11641**  
(11501193)  
Phosphate

M10-1.50 x 40mm  
Hex Head Sems®  
Class 9.8  
15mm Hex  
29mm (1-5/32")  
Washer O.D.  
GM

UNIT PACKAGE: 25

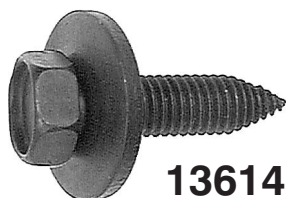

**13614**  
(11501188)  
Phosphate

M8-1.25 x 30mm  
Hex Head Sems®  
Class 9.8; 13mm Hex  
24mm (15/16") Wshr O.D.  
GM

UNIT PACKAGE: 25



**16931**  
(N606692-S2,  
AB-187EH)  
Phosphate

M8-1.25 x 42mm  
Hex Hd. Sems®  
With Dog Pt.  
22mm (7/8")  
Washer O.D.  
Class 9.8  
10mm Hex  
Ford

UNIT PACKAGE: 25

M10-1.50 x 30mm  
Hex Washer Head  
With Dog Point  
24mm Washer Head O.D.  
15mm Hex  
Dodge Truck  
2000 - On

UNIT PACKAGE: 25

M10-1.50 x 40mm  
Hex Head Sems®  
Class 9.8  
15mm Hex  
29mm (1-5/32")  
Washer O.D.  
GM

UNIT PACKAGE: 25

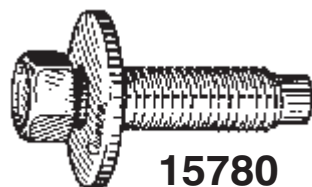

**15780**  
(N606690-S2)  
Phosphate

M8-1.25 x 33mm  
Hex Head Sems®  
With Dog Point  
Class 9.8; 10mm Hex  
22mm (7/8") Washer O.D.  
Ford

UNIT PACKAGE: 50



**19664**  
(12619608)  
Plain

M10-1.5 x 15mm  
Hex Washer Head  
With Locking Patch  
On the Thread  
Class 9.8; 15mm Hex  
20mm (13/16")  
Washer Hd. O.D.  
Transmission Torque  
Converter Bolt  
GM 1979-On

UNIT PACKAGE: 15



**13619**  
Phosphate

M10-1.50 x 30mm  
Hex Head Sems®  
Class 9.8  
29mm (1-1/8")  
Wshr O.D.  
15mm Hex

UNIT PACKAGE: 10

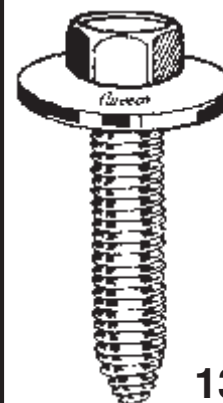

**13620**  
Phosphate

M10-1.50 x 45mm  
Hex Head Sems®  
Class 9.8  
15mm Hex  
30mm (1-3/16")  
Washer O.D.

UNIT PACKAGE: 10

# METRIC ITEMS



**16741**  
(14001842)  
Zinc

M10-1.50 x 46mm  
Hex Washer Head  
Class 9.8  
15mm Hex  
22mm (7/8") Washer Hd. O.D.  
Starter Bolt  
GM

UNIT PACKAGE: 5

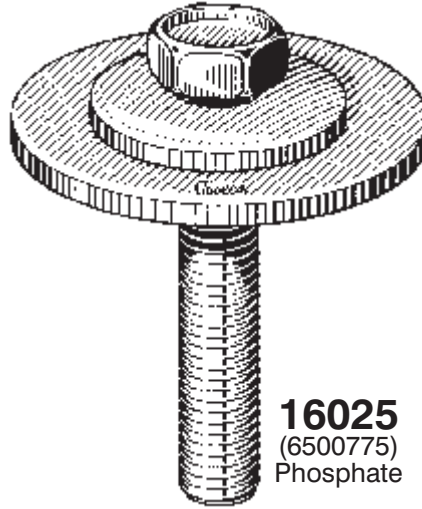

**16025**  
(6500775)  
Phosphate

M10-1.50 x 60mm  
Hex Head Sems®  
Class 10.9 15mm Hex  
32mm (1-1/4") Sm. Washer O.D.  
52mm (2-1/16") Lg. Washer O.D.  
Alternator Mounting Bracket  
Chrysler

UNIT PACKAGE: 5

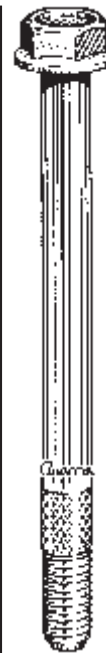

Not Actual Size

**16742**  
(14001841)  
Zinc

M10-1.50 x 114mm  
Hex Washer Head  
21mm (13/16")  
Washer Head O.D.  
Class 9.8  
15mm Hex  
GM Starter Bolt

UNIT PACKAGE: 5

## METRIC SPECIAL TAPPING SCREWS



### Metric Torx® Head Tapping Screws 300 Series Stainless Steel

Auveco Part No.	Size	Head Style	GM Number	Finish	Unit Pkg.
14572	M4.2-1.41 x 13mm	M8 Pan	11504646	Chrome	50
14052	M4.2-1.41 x 16mm	M8 Pan	11508879	Black Ox	50
11937	M4.2-1.41 x 20mm	M7 Oval	11504069	Chrome	50
11938	M4.2-1.41 x 20mm	M7 Oval	11504659	Black Ox	50
14950	M4.2-1.41 x 20mm	M8 Oval	11504477	Chrome	50
11943	M4.2-1.41 x 20mm	M8 Pan	11504647	Chrome	50
11944	M4.2-1.41 x 20mm	M8 Pan	11504655	Black Ox	50
14051	M4.2-1.41 x 20mm	M8 Pan	11508561	Black Ox	50
	12mm Washer O.D. Sems®				
14046	M4.2-1.41 x 25mm	M8 Pan	11504662	Black Ox	50
14049	M4.2-1.41 x 25mm	M8 Pan	11504661	Chrome	50
14053	M4.2-1.41 x 25mm	M7 Oval	11505182	Black Ox	50
14569	M4.2-1.41 x 25mm	M7 Oval	11504551	Chrome	50
11939	M4.2-1.41 x 30mm	M7 Oval	11504522	Chrome	50
11940	M4.2-1.41 x 30mm	M7 Oval	11504656	Black Ox	50
14050	M4.2-1.41 x 30mm	M8 Pan	11505835	Black Ox	50
11945	M4.2-1.41 x 35mm	M8 Pan	11504663	Chrome	25
14047	M4.2-1.41 x 35mm	M7 Oval	11504785	Black Ox	50
11941*	M4.2-1.41 x 40mm	M7 Oval	11504654	Chrome	25
14952*	M4.2-1.41 x 55mm	M8 Pan	14083901	Black Ox	50

\* Not Fully Threaded

For an Assortment of Metric Tapping Screws, see Fix Kit No. 6171 in the green pages.

# Sec. 7

# METRIC ITEMS

## Metric Torx® Insert Bits For Torx® Screws

1" Shank



Auveco Part No.	Bit Size	For Screw Size	Unit Pkg.
12472	T-10	No. 4	1
11949	T-15	No. 6, M4.2	1
11950	T-20	No. 8, M4.2	1
12103	T-25	No. 10	1
14913	T-27	No. 12, 1/4"	1
12104	T-30	1/4", M6	1
12105	T-40	5/16", M8	1
14914*	T-45	3/8", 7/16"	1
14915*	T-50	7/16", 1/2"	1
14916*	T-55	1/2", 9/16", 5/8"	1

\* 1-1/4" Shank



### 12062

(11501903)  
Black Oxide

M4.2-1.41 x 10mm  
(#8 x 13/32")  
Phillips Washer Head  
Pozi-Driv  
11mm (7/16") Washer Hd. O.D.  
GM

UNIT PACKAGE: 100



### 12059

(11501883)  
Zinc

M4.2-1.41 x 13mm  
(#8 x 33/64")  
Phillips Washer Head  
11mm (7/16") Washer Hd. O.D.  
GM

UNIT PACKAGE: 100



### 15941

Black Oxide

M4.2-1.41 x 12mm  
(#8 x 15/32")  
Phillips Truss Head  
9.5mm (3/8") Hd. Diameter  
Japanese Imports

UNIT PACKAGE: 10

### 16596

Same As 15941  
Except For Unit Package

UNIT PACKAGE: 100



### 12061

(11501896)  
Black Oxide

M4.2-1.41 x 13mm  
(#8 x 33/64")  
Phillips Round Washer Hd  
Pozi-Driv  
8.5mm (11/32")  
Washer Hd. O.D.  
GM

UNIT PACKAGE: 100



### 12739

(11501794)  
Chrome

M4.2-1.41 x 12mm  
(#8x 15/32")  
Phillips Washer Head  
Pozi-Driv  
10mm (25/64") Washer Hd. O.D.  
GM

UNIT PACKAGE: 100



### 13712

(11505104)  
Black Zinc

M4.2-1.41 x 13mm  
(#8 x 33/64")  
Phillips Washer Head  
11mm (7/16")  
Washer Hd. O.D.  
GM

UNIT PACKAGE: 50



# METRIC ITEMS

## Sec. 7



**12740**  
(11503394)  
Phosphate  
M4.2-1.41 x 13mm  
(#8 x 33/64")  
Hex Head Sems®  
12mm (15/32") Wshr O.D.  
7mm Hex  
GM  
UNIT PACKAGE: 100



**12743**  
(11502843)  
Zinc  
M4.2-1.41 x 13mm  
(#8 x 33/64")  
Hex Washer Head  
9mm (11/32") Washer O.D.  
7mm Hex  
GM  
UNIT PACKAGE: 100



**15721**  
(11504010)  
Phosphate  
M4.2-1.41 x 13mm  
(#8 x 19/32")  
Indented Hex Head Sems®  
16mm (5/8") Washer O.D.  
7mm Hex  
GM  
UNIT PACKAGE: 50



**18781**  
(11515566)  
Phosphate  
M4.2-1.41 x 14mm  
(#8 x 9/16")  
Hex Head Sems®  
8mm (5/16") Washer O.D.  
7mm Hex  
GM  
UNIT PACKAGE: 50



**18817**  
(1746408)  
Zinc & Black  
M4.2-1.41 x 16mm  
(#8 x 41/64")  
Phillips Round Washer Hd.  
w/Serrations Under The Hd  
Pozi-Driv  
With Teks® Point  
11mm (7/16")  
Washer Head O.D.  
Moulding, Trim &  
General Purpose  
GM  
UNIT PACKAGE: 100



**16720**  
Black Oxide  
M4.2-1.41 x 16mm  
(#8 x 5/8")  
Phillips Truss Head  
9.5mm (3/8") Head Dia.  
Honda  
UNIT PACKAGE: 100



**17483**  
(90082-35011)  
Zinc & Black  
M4.2-1.41 x 16mm  
(#8 x 5/8")  
Phillips Round  
Washer Head  
10mm (25/64")  
Washer Head O.D.  
Door Panel Arm Rests,  
Power Windows & Locks  
Toyota Camry  
UNIT PACKAGE: 100



**12741**  
(11503395)  
Phosphate  
M4.2-1.41 x 16mm  
(#8 x 5/8")  
Hex Head Sems®  
12mm (15/32") Wshr O.D.  
7mm Hex  
GM  
UNIT PACKAGE: 100



**18523**  
(N800322-S55)  
Black  
375 Hour Salt Spray  
M4.2-1.41 x 16mm  
(#8 x 5/8")  
Hex Head Sems®  
12mm (15/32") Wshr O.D.  
5mm Hex  
Ford  
UNIT PACKAGE: 50



**18261**  
(11503578,  
11503785)  
Phosphate  
M4.2-1.41 x 16mm  
(#8 x 5/8")  
Hex Washer Head Sems®  
With Teks® Point  
12mm (1/2") Washer O.D.  
7mm Hex  
GM  
UNIT PACKAGE: 50

Remember...  
All Items In This  
Catalog Are  
Available In Bulk.  
Call For A Quote.



**12060**  
(11501884)  
Black Oxide  
M4.2-1.41 x 20mm  
(#8 x 25/32")  
Phillips Washer Head  
11mm (7/16") Wshr Hd. O.D.  
GM  
UNIT PACKAGE: 100



**12097**  
(9420052,  
11502483,  
11503503)  
Chrome  
M4.2-1.41 x 20mm  
(#8 x 25/32")  
Phillips Pan Head Sems®  
Pozi-Driv  
12mm (1/2") Washer O.D.  
GM  
UNIT PACKAGE: 50



**12738**  
(11504056, 11513801)  
Phosphate  
M4.2-1.41 x 20mm  
(#8 x 25/32")  
Hex Washer Head Sems®  
12mm (1/2") Washer O.D.  
7mm Hex  
Radiator & Grille  
GM  
UNIT PACKAGE: 50

# Sec. 7

# METRIC ITEMS



**12742**

(11503396,  
11503483)  
Phosphate

M4.2-1.41 x 20mm  
(#8 x 25/32")  
Hex Head Sems®  
12mm (1/2") Washer O.D.  
7mm Hex  
Front End & Air Cond.  
GM

UNIT PACKAGE: 100



**19278**

(14090382)  
Black Phosphate

M4.2-1.41 x 20mm  
(#8 x 25/32")  
Hex Head Sems®  
20mm Washer O.D.  
7mm Hex  
GM

UNIT PACKAGE: 50

FasTrack®  
Auveco's Cost  
Recovery System  
For Repair  
Fasteners.



**18336**

Phosphate

M4.2-1.41 x 25mm  
(#8 x 1")  
Hex Head Sems®  
12mm (1/2") Washer O.D.  
7mm Hex

UNIT PACKAGE: 100

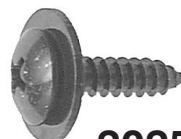

**20259**

(90114-SE0-000)  
Black E-Coat

M4.8-1.61 x 19mm  
(#10 x 3/4")  
Phillips Truss Head Sems®  
Washer O.D.: 16mm  
Splash Shield &  
General Purpose  
Honda  
1986 - On

UNIT PACKAGE: 25

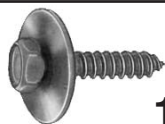

**15373**

(1640810, 11503892,  
11500434)  
Phosphate

M4.2-1.41 x 20mm  
(#8 x 25/32")  
Hex Head Sems®  
16mm (5/8") Washer O.D.  
7mm Hex; GM

UNIT PACKAGE: 50



**15775**

Phosphate

M4.2-1.41 x 20mm  
(#8 x 25/32")  
Hex Head Sems®  
With Teks® Point  
12mm (1/2") Washer O.D.  
7mm Hex

UNIT PACKAGE: 50



**20455**

Black Phosphate

M4.8-2.12 x 20mm  
(#10 x 25/32")  
Phillips Truss Head  
14mm Head O.D.  
Imports

UNIT PACKAGE: 50



**20271**

(N801603-S2)  
Phosphate

M4.2-1.41 x 20mm  
(#8 x 25/32")  
Phillips Pan Head Sems®  
16mm (5/8") Washer O.D.  
Ford

UNIT PACKAGE: 50



**19006**

Phosphate

M4.2-1.41 x 25mm  
(#8 x 1")  
Round Washer Head  
Pozi-Driv  
With Teks® Point  
11mm (7/16")  
Washer Head O.D.  
General Purpose

UNIT PACKAGE: 100



**19653**

(N811534-S61)  
Black Phosphate

M4.2-1.41 x 30mm  
(#8 x 1-3/16")  
Hex Head Sems®  
17mm (11/16")  
Washer O.D.  
7mm Hex  
Ford

UNIT PACKAGE: 15



**19181**

(W700501-S303)  
Black Organic

M5-2.2 x 15mm  
(#12 x 19/32")  
Torx® Pan Head Sems®  
20mm (25/32")  
Washer O.D.  
12mm (1/2") Head O.D.  
T-30 Drive  
Ford Contour & Mystique  
1995-On

UNIT PACKAGE: 25



**20476**

Phosphate

M4.2-1.41 x 20mm  
(#8 x 25/32")  
Hex Washer Head  
Sems® Teks®  
17mm (11/16")  
Washer O.D.  
7mm Hex  
General Purpose

UNIT PACKAGE: 50



**20382**

Not Available From O.E.M.  
Black Zinc

M4.2-1.41 x 25mm  
(#8 x 1")  
Torx® Pan Head Sems®  
T-15 Drive  
12mm (1/2") Washer O.D.

UNIT PACKAGE: 50



**18340**

Black  
Phosphate

M4.8-1.61 x 15mm  
(#10 x 19/32")  
Phillips Truss Head  
14mm Head O.D.  
Nissan Bumpers

UNIT PACKAGE: 50



**17459**

Black Oxide

M4.8-1.61 x 16mm  
(#10 x 5/8")  
Phillips Truss Head  
11mm (7/16") Head Dia.  
Imports

UNIT PACKAGE: 100



**19251**

Black Zinc

M5-1.59 x 16mm  
Phillips Hex Head Sems®  
16mm Washer O.D.  
8mm Hex

UNIT PACKAGE: 50

**METRIC ITEMS**



**17461**

Zinc & Yellow Dichromate

M5.5-1.81 x 18mm  
 (#12 x 45/64")  
 Hex Head Sems®  
 15mm (19/32")  
 Washer O.D.  
 8mm Hex  
 Imports

UNIT PACKAGE: 50



**12318**

(11502453)  
 Zinc

M6.3-1.81 x 13mm  
 (#14 x 33/64")  
 Hex Washer Head  
 12.5mm (1/2")  
 Washer Hd. O.D.  
 10mm Hex  
 GM

UNIT PACKAGE: 50



**12319**

(11502873)  
 Phosphate

M6.3-1.81 x 13mm  
 (#14 x 33/64")  
 Hex Washer Head  
 Type B  
 12.5mm (1/2")  
 Washer Hd. O.D.  
 10mm Hex  
 GM

UNIT PACKAGE: 50



**19718**

(6501220)  
 Mechanical Zinc  
 & Yellow Chromate

M6.3-1.81 x 16mm  
 (#14 x 5/8")  
 Torx® Drive Oval Head  
 T-30 Drive  
 13mm (1/2") Head O.D.  
 Door Latch Mounting  
 Chrysler 1996-86

UNIT PACKAGE: 50



**19170**

Black Phosphate

M6.3-1.81 x 16mm  
 (#14 x 5/8")  
 Phillips Truss Head  
 15mm (19/32") Head O.D.  
 Japanese Imports

UNIT PACKAGE: 50



**15776**

(N800312-S2)  
 Phosphate

M6.3-1.81 x 16mm  
 (#14 x 5/8")  
 Hex Head Sems®  
 16mm (5/8") Washer O.D.  
 8mm Hex  
 Ford

UNIT PACKAGE: 50



**12057**

(11500994)  
 Phosphate

M6.3-1.81 x 16mm  
 (#14 x 5/8")  
 Hex Head Sems®  
 17mm (11/16") Washer O.D.  
 10mm Hex  
 GM

UNIT PACKAGE: 50

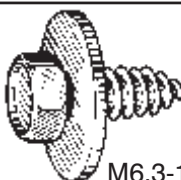

**15962**

Zinc &  
 Yellow  
 Dichromate

M6.3-1.81 x 18mm  
 (#14 x 23/32")  
 Hex Head Sems®  
 22mm (7/8") Washer O.D.  
 10mm Hex  
 Honda, Nissan, Toyota

UNIT PACKAGE: 25



**13019**

(N610959-S2)  
 Phosphate

M6.3-1.81 x 19mm  
 (#14 x 3/4")  
 Hex Washer Head  
 11.5mm (29/64") Wshr O.D.  
 8mm Hex  
 Ford

UNIT PACKAGE: 50



**20556**

Black Zinc

M6.3-1.81 x 20mm  
 (#14 x 25/32")  
 Phillips Hex Head Sems®  
 16mm (5/8") Washer O.D.  
 10mm Hex  
 Imports

UNIT PACKAGE: 50

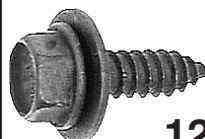

**12351**

(11505022)

Black Polyseal Finish

M6.3-1.81 x 20mm  
 (#14 x 25/32")  
 Hex Washer Head Sems®  
 17mm (11/16") Washer O.D.  
 10mm Hex  
 GM

UNIT PACKAGE: 50

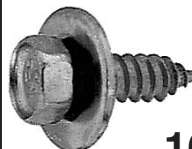

**16828**

Zinc & Yellow Dichromate

M6.3-1.81 x 20mm  
 (#14 x 25/32")  
 Hex Head Sems®  
 18mm (45/64") Washer O.D.  
 10mm Hex  
 Honda, Nissan, & Toyota

UNIT PACKAGE: 25



**20557**

Black Zinc

M6.3-1.81 x 20mm  
 (#14 x 25/32")  
 Phillips Hex Head Sems®  
 20mm (25/32") Washer O.D.  
 10mm Hex  
 Imports

UNIT PACKAGE: 50

Submitted by "Pop"  
Gale

"The bitterness  
of poor  
quality lingers  
long after  
the sweetness  
of a low price is  
forgotten."



**12347**  
(11500081, 11508905)  
Phosphate

M6.3-1.81 x 30mm  
(#14 x 1-3/16")  
Hex Washer Head  
11.5mm (29/64")  
Washer Hd. O.D.  
10mm Hex  
GM

UNIT PACKAGE: 50

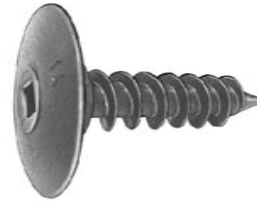

**19417**  
(6503819, 6503401)  
Black Nylon

M7.5 x 35mm  
Square Drive Truss Head  
22mm Head Diameter  
9mm Shoulder Diameter  
Foam To Bumper Fascia  
Chrysler  
1993-On

UNIT PACKAGE: 15



**12339**  
(11500996, 11505023)  
Phosphate

M6.3-1.81 x 25mm  
(#14 x 1")  
Hex Head Sems®  
17mm (21/32") Washer O.D.  
10mm Hex  
GM

UNIT PACKAGE: 50



**12354**  
(11500997)  
Phosphate

M6.3-1.81 x 30mm  
(#14 x 1-3/16")  
Hex Head Sems®  
17mm (21/32") Washer O.D.  
10mm Hex  
GM

UNIT PACKAGE: 50

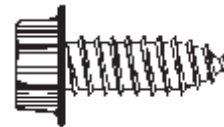

**12350**  
(11500086)  
Phosphate

M8-2.12 x 20mm  
(5/16"-12 x 25/32")  
Hex Washer Head  
16mm (5/8") Washer Hd. O.D.  
13mm Hex  
GM

UNIT PACKAGE: 25

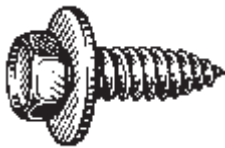

**12352**  
(11504515)  
Zinc

M6.3-1.81 x 25mm  
(#14 x 1")  
Hex Head Sems®  
17mm (21/32") Washer O.D.  
10mm Hex  
GM

UNIT PACKAGE: 50

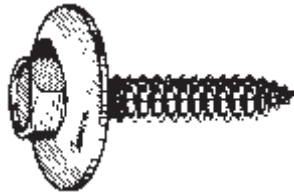

**12068**  
(11504981)  
Phosphate

M6.3-1.81 x 30mm  
(#14 x 1-3/16")  
Hex Head Sems®  
24mm (15/16") Washer O.D.  
10mm Hex  
GM

UNIT PACKAGE: 50

# METRIC ITEMS

(Illustrations Actual Size)



**12659**

(11502479, 11502480,  
12338141)  
Zinc

M8-1.25 x 20mm  
Stainless Steel Capped  
Pan Head w/o Nuts  
Head Diameter: 19mm  
Shoulder Length: 2mm  
GM

UNIT PACKAGE: 25

**12660**

Same as 12659 except  
With Hex Nuts

UNIT PACKAGE: 25

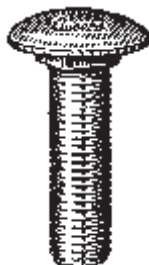

**15310**

(11503687)  
Phosphate

M8-1.25 x 30mm  
Uncapped Round Head  
w/o Nuts  
Head Diameter: 17.5mm  
Shoulder Length: 3mm  
GM

UNIT PACKAGE: 25



**17187**

(N800883-S100)  
Black Phosphate

M12-1.75 x 40mm  
Stainless Steel Cap w/o Nuts  
Sealing Patch On Threads  
Head Diameter: 28mm  
Shoulder Length: 5mm  
Ford Truck F 150/350  
& U 150 1992-80

UNIT PACKAGE: 5



**16986**

(14003784)  
Zinc

M8-1.25 x 25mm  
Stainless Steel Capped  
Pan Head w/o Nuts  
Head Diameter: 19mm  
Shoulder Length: 3mm  
GM

UNIT PACKAGE: 25

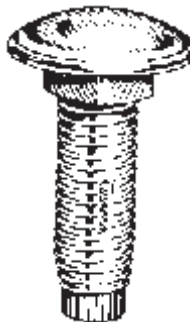

**16932**

(N-802081-S100,  
AB-305L)  
Black Zinc

M10-1.5 x 33mm  
Stainless Steel Cap w/o Nuts  
Head Diameter: 23mm  
Shoulder Length: 5mm  
Ford Truck

UNIT PACKAGE: 5

**“If a picture is worth  
1,000 words then a  
sample is worth 1,000  
pictures.”**

**“Pop” Gale**

**Call our Customer  
Service Department  
When You Need A  
Sample**

# Sec. 7

# METRIC ITEMS

## Metric Threaded Rod

Regular Pitch • DIN 975 • Zinc Plated  
Tensile Strength: 34,800

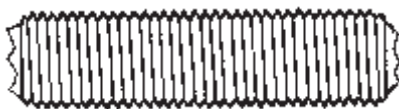

Auveco Part No.	Thread Size	Length	Unit Pkg.
11284	M8-1.25	1 Meter (39")	3
11286	M12-1.75	1 Meter (39")	2

**All Items Available In Bulk.**



**11403**  
(N14-443-4)  
Plain

M8-1.25 x 38mm  
Volkswagen Exhaust Manifold  
UNIT PACKAGE: 25

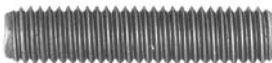

**11404**  
(N14-4003)  
Plain

M8-1.25 x 35mm  
Volkswagen Intake Manifold  
UNIT PACKAGE: 25

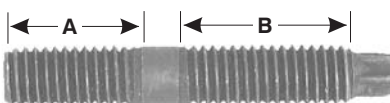

**18514**  
(21006951)  
Phosphate

M8-1.25 x 50mm  
Dim. A: 17mm Dim. B: 20mm  
Torx® Drive  
Intake Manifold  
GM Saturn

UNIT PACKAGE: 25



**17559**

Zinc & Yellow Dichromate

M10-1.25 x 42mm  
Dim. A: 10mm Dim. B: 21mm  
Class 8.8  
Exhaust Systems  
Honda, Nissan & Toyota

UNIT PACKAGE: 10



**17560**

Zinc & Yellow Dichromate

M10-1.25 x 48mm  
Dim. A: 15mm Dim. B: 25mm  
Class 8.8  
Exhaust Systems  
Honda, Nissan & Toyota

UNIT PACKAGE: 10

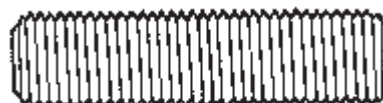

**17596**

Zinc & Yellow Dichromate

M12-1.25 x 50mm  
Class 8.8  
Catalytic Converter  
Mazda

UNIT PACKAGE: 5

## Cylinder Head And Manifold Metric Studs

Grade 8 Medium Carbon Heat Treated Steel  
Regular Pitch

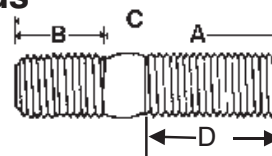

Auveco Part No.	A Diameter & Length	B Diameter & Length	C Overall Length	D Length	Unit Pkg.
11973	6mm-1.00 x 20mm	6mm-1.00 x 7.5mm	27.5mm	18mm	10
11974	6mm-1.00 x 25mm	6mm-1.00 x 7.5mm	32.5mm	18mm	10
11980	8mm-1.25 x 20mm	8mm-1.25 x 10mm	30.0mm	16mm	10
11981	8mm-1.25 x 25mm	8mm-1.25 x 10mm	35.0mm	22mm	10
11982	8mm-1.25 x 30mm	8mm-1.25 x 10mm	40.0mm	22mm	10
11983	8mm-1.25 x 35mm	8mm-1.25 x 10mm	45.0mm	22mm	10
11984	8mm-1.25 x 40mm	8mm-1.25 x 10mm	50.0mm	22mm	10
11987	8mm-1.25 x 55mm	8mm-1.25 x 10mm	65.0mm	22mm	10
11989	10mm-1.50 x 30mm	10mm-1.50 x 12mm	42.0mm	18mm	10
11990	10mm-1.50 x 35mm	10mm-1.50 x 12mm	47.0mm	26mm	10
11991	10mm-1.50 x 40mm	10mm-1.50 x 12mm	52.0mm	26mm	10
11993	10mm-1.50 x 50mm	10mm-1.50 x 12mm	62.0mm	26mm	10
11995	10mm-1.50 x 60mm	10mm-1.50 x 12mm	72.0mm	26mm	5
11998	12mm-1.75 x 30mm	12mm-1.75 x 15mm	45.0mm	25mm	5



## DIN 934 Regular Pitch Metric Hex Nuts

Steel • Zinc Plated • Class 8  
Tensile Strength: 116,000 Max.

Auveco Part No.	Size	Pitch (mm)	Hex Width	Unit Pkg.
10569	4mm	.70	7mm	25
14448	4mm	.70	7mm	50
10570	5mm	.80	8mm	25
14449	5mm	.80	8mm	50
10571	6mm	1.00	10mm	25
14450	6mm	1.00	10mm	100
10572	7mm	1.00	11mm	25
14451	7mm	1.00	11mm	50
10573	8mm	1.25	13mm	25
14452	8mm	1.25	13mm	100
10575	10mm	1.50	17mm	10
14454	10mm	1.50	17mm	50
10576	12mm	1.75	19mm	10
14455	12mm	1.75	19mm	25
14625	14mm	2.00	22mm	25
14626	16mm	2.00	24mm	25
14627	20mm	2.50	30mm	10



## DIN 934 Fine Pitch Metric Hex Nuts

Steel • Zinc Plated • Class 8  
Tensile Strength: 116,000 Max.

Auveco Part No.	Size	Pitch (mm)	Hex Width	Unit Pkg.
10574	8mm	1.00	13mm	25
14453	8mm	1.00	13mm	50
11277	10mm	1.00	17mm	10
14456	10mm	1.00	17mm	25
11278	10mm	1.25	17mm	10
14457	10mm	1.25	17mm	25
11279	12mm	1.25	19mm	10
14458	12mm	1.25	19mm	25
11280	12mm	1.50	19mm	10
14459	12mm	1.50	19mm	25
14629	16mm	1.50	24mm	25



## J.I.S. Small Hex Nuts

J.I.S. B1181 • Steel • Heat Treated  
I.S.O. Class 8 Zinc Plated

Auveco Part No.	Dia.	Pitch mm	Hex Width	Unit Pkg.
14796	8mm	1.25	12mm	25
17391	8mm	1.25	12mm	100
14797	10mm	1.25	14mm	15
17392	10mm	1.25	14mm	50
16617	12mm	1.25	17mm	25



## DIN 439 Metric Hex Machine Screw (Jam) Nuts

Regular Pitch • Class 6S • Zinc Plated  
Heat Treated Alloy Steel

Auveco Part No.	Unit Pkg.	Size	Pitch (mm)	Hex Width
11043	100	5mm	.80	8mm



## DIN 985 Metric Nylon Insert Lock Nuts

Regular Pitch  
Heat Treated Alloy Steel • Zinc Plated

Auveco Part No.	Unit Pkg.	Size	Pitch (mm)	Hex Width
11049	100	4mm	.70	7mm
11051	100	5mm	.80	8mm
11053	100	6mm	1.00	10mm
11055	100	8mm	1.25	13mm
11057	100	10mm	1.50	17mm
11059	100	12mm	1.75	19mm



Split Collar

## Metric Lock Nuts

Copper Plated Steel

Auveco Part No	Size	Pitch (mm)	Hex Width	Unit Pkg.
16137	6mm	1.00	10mm	25
19217	8mm	1.25	12mm	25
20461	10mm	1.50	14mm	25

# Sec. 7

# METRIC ITEMS



Type A



Type B

## Metric Free Spinning Washer Nuts

Auveco Part No.	Thread Size	Type	Washer O.D.	Hex Size	Height	Plating	O.E.M. No.	Unit Pkg.	
15325	M4-0.7	B	12mm	9mm	4.5mm	Phosphate	N621900, N800466	50	
18532	M4-0.7	B	14mm	10mm	8mm	Zinc	6503169	50	
16883	M5-0.8	B	10mm	8mm	7mm	Zinc & Yellow	N802775-S36	50	
15326	M5-0.8	B	15mm	10mm	7mm	Phosphate	N621903	50	
15327	M5-0.8	B	19mm	10mm	7mm	Phosphate	11504614	50	
19216	M6-1.0	B	14mm	10mm	8mm	Phosphate	6100047	50	
12595	M6-1.0	A	16mm	10mm	7mm	Phosphate	11505329, 11503752, N90100001	25	
16268	Same as 12595 except for packaging								50
15328	M6-1.0	B	16mm	11mm	8.5mm	Phosphate	N621905	50	
16136	M6-1.0	B	18mm	10mm	7mm	Zinc & Yellow		25	
15329	M6-1.0	B	18mm	10mm	9mm	Phosphate	6100048	50	
12596	M6-1.0	A	19mm	11mm	9.5mm	Phosphate	11503754, 11503756	25	
15330	M6-1.0	B	19mm	10mm	8mm	Zinc	11508275	50	
16774	M6-1.0	B	19mm	11mm	9mm	Zinc & Yellow	N621906-S36	50	
15323*	M6-1.0	B	19mm	10mm	11mm	Zinc	11505475	25	
15331	M6-1.0	B	20mm	10mm	9mm	Phosphate	6100049	50	
15332	M6-1.0	B	24mm	11mm	9mm	Zinc & Yellow	N621907	25	
16886	M6-1.0	A	32mm	10mm	7mm	Phosphate	20731447	50	
11642	M6.3-1.0	A	16mm	11mm	9mm	Phosphate	11500747, 11501106	50	
15333	M8-1.25	B	18mm	13mm	10mm	Phosphate	6100050	25	
15334	M8-1.25	B	19mm	13mm	10mm	Phosphate	11501800	25	
15335	M8-1.25	B	24mm	13mm	10.5mm	Phosphate	11503695, 11506117, N621940	25	
15337	M10-1.5	B	24mm	15mm	13mm	Phosphate	N621942	25	

\*With Sealer



## Metric Flange Lock Nuts



Auveco Part No.	Thread Size	Flange O.D.	Hex Size	Height	Plating	O.E.M. No.	Unit Pkg.
18251	M6-1.0	14mm	10mm	6mm	Zinc & Yellow		50
15316	M6-1.0	14mm	10mm	7.5mm	Phosphate	N620480	50
11709	M8-1.25	17mm	13mm	8.5mm	Zinc	11502811	50
15317	M8-1.25	17mm	13mm	9mm	Phosphate	N801310	50
15318	M10-1.5	20.5mm	15mm	13mm	Phosphate	N620482	25
11708	M10-1.5	21mm	15mm	11.5mm	Zinc	11502812	25
14521	M10-1.5	21mm	15mm	12mm	Phosphate		25
14522	M12-1.75	25mm	18mm	14mm	Phosphate		25
15319	M12-1.75	25mm	21mm	23mm	Phosphate	N802073	10
14523	M16-2.0	33mm	24mm	18mm	Phosphate		10



**METRIC ITEMS**  
**Metric Hex Flange Nuts**



Auveco Part No.	Thread Size	Flange O.D.	Hex Size	Height	Plating	O.E.M. No.	Unit Pkg.
16880	M4-7	11mm	7mm	5mm	Black Zinc	14031900	50
17495*	M4-7	14mm	8mm	6mm	Zinc & Yellow	N620391-S36	50
19309	M5-8	11.5mm	8mm	5mm	Black Oxide		50
19308	M5-8	11.5mm	8mm	5mm	Zinc	11502702	50
19205	M6-1.0	14mm	10mm	6mm	Phosphate	11503745	100
20450	M6.3-1.81	20mm	11mm	7mm	Zinc Organic	22516030	25
11644	M8-1.25	17mm	13mm	8mm	Phosphate	11501889	25
16269	Same As 11644 Except For Packaging					11502609, 11507036	50
18253	M10-1.25	19mm	14mm	9mm	Zinc & Yellow		50
11645	M10-1.5	21mm	15mm	10mm	Phosphate	11501850	25
20606	M12-1.75	25mm	18mm	12mm	Phosphate		25

\* With Sealer



**Metric Spin Lock Nuts With Serrations**

Case Hardened



Auveco Part No.	Thread Size	Flange O.D.	Hex Size	Plating	Unit Pkg.
-----------------	-------------	-------------	----------	---------	-----------

**Standard Flange**

16769	M6-1.0	14mm	10mm	Zinc	50
16830	M8-1.25	17mm	12mm	Zinc	50
16470	M10-1.25	19mm	14mm	Zinc	25

**Large Flange**

14855	M6-1.0	17mm	10mm	Phos	100
14856	M8-1.25	19mm	13mm	Phos	100

**Nylon Coated Acorn Nuts**



Type A



Type B



Type C

Auveco Part No.	Type	Size	Hex	Height	Unit Pkg.
-----------------	------	------	-----	--------	-----------

20570	C	M4-0.7	10mm	11mm	15
15155•	A	5mm	11mm	10mm	50
15715•	B	5mm	11mm	8mm	50

• Thread Cutting



**Metric Hex Lock Nuts**

Auveco Part No.	Thread Size	Hex Size	Finish	Unit Pkg.
-----------------	-------------	----------	--------	-----------

12110	M4-7	9mm	Phosphate	50
-------	------	-----	-----------	----



**Metric Wing Nuts**

DIN D00213 -Zinc Plated

Auveco Part No.	Thread Size	Unit Pkg.
-----------------	-------------	-----------

17010	M6-1.0	25
-------	--------	----



**11711**  
(11054611)  
Zinc

M10-1.0  
Nylon Insert Lock Nut  
17mm Hex  
Height: 7/32"

UNIT PACKAGE: 10



**18531**  
(6503837)  
Black

Ziptwist Wing Nut  
Fits 6mm Stud  
5/8" O.D.

UNIT PACKAGE: 50



**15811**  
(10129981)  
Zinc

M14-2.0; Lock Nut  
24mm Hex; GM

UNIT PACKAGE: 10



**14185**  
(11508987)

Black Phosphate

3.2mm (1/8") Stud Size; Thread Cutting Nut  
7mm Hex; 2mm High; GM

UNIT PACKAGE: 100



**16929**  
(25556181)  
Bright Zinc

6mm Stud Size; Thread Cutting Nut  
11mm Hex; 3mm High; GM

UNIT PACKAGE: 100



**Metric Washer Lock Nuts**



Auveco Part No.	Thread Size	Flange Diameter	Finish	Height	Hex Size	O.E.M. Number	Unit Pkg.
15714 w/Sealer	M4-.7	12mm	Phos	6mm	9mm	11501854	50
12254	M5-.8	14mm	Zinc	6mm	10mm	11501814	100
19375	M5-.8	18mm	Bk. Org.	7mm	10mm	15613187	50
12249	M6-1.0	18mm	Phos	7mm	11mm	477418	50
12250 w/Sealer	M6-1.0	18mm	Phos	9mm	11mm		50



**Washer Type Metric Self-Threading Nuts**



Auveco Part No.	Stud Size	Hex Width	Washer Dia.	Finish	O.E.M. Number	Unit Pkg.
12251	3.2mm	8mm	11mm	Phos	11502556	25
12115	4mm	9mm	15mm	Zinc & Yellow	11502549	100
12116	5mm	10mm	15mm	Phos	11508900	50
19617	5mm	10mm	15mm	Zinc & Yellow	15002519	100
12253	5mm	10mm	15mm	Phos	11501835, 10062	50
19548	6mm	11mm	15mm	Zinc	6100814	50
16829	6mm	11mm	18mm	Zinc	6100815	100
12117	6.3mm	11mm	18mm	Zinc	11503432	50
12255	6.3mm	11mm	18mm	Zinc	11501836	50
12256	6.3mm	11mm	18mm	Zinc w/Sealer	11501851	50
12257	6.3mm	11mm	24mm	Zinc w/Sealer	11501899	25
15711	8mm	13mm	20mm	Zinc	11502507, 11509535, 11514282	100



**Metric Push-On Retainers**

For Non-Threaded Fasteners



Auveco Part No.	Stud Size	Diameter	Finish	O.E.M. Number	Unit Pkg.
12118	3.2mm	9.5mm	Zinc		100
12119	4mm	11mm	Phos		100
15713	5mm	11mm	Zinc & Yellow	11508654	100
20317	5mm	24mm	Zinc	6505049AA	50



**Metric Pushnut Bolt Retainers**

For Threaded Fasteners



Auveco Part No.	Thread Size	O.D.	Finish	Unit Pkg.
12122	M5-0.8	11mm	Zinc	100
12123	M6-1.0	12.7mm	Zinc	100
14980	M6-1.0	17mm	Zinc	100
12124	M6.3-1.0	12.7mm	Zinc	100
12125	M8-1.25	15.9mm	Zinc	100
12259	M8-1.25	24mm	Dacromet	50
12126	M10-1.50	19.8mm	Phosphate	50
12260	M10-1.50	24mm	Dacromet	100
12127	M12-1.75	21.4mm	Zinc	50
16980	M14-2.0	25mm	Phosphate	50

**METRIC ITEMS**

**Tubular Type Nuts (Listed By Stud Size)**



**13185**  
(803-853-213)  
Nylon

For 2mm Stud  
Fits Into 3mm Hole  
Over Length: 7mm

UNIT PACKAGE: 50



**16146**  
Nylon

For 3mm Stud  
Fits Into 4.5mm Hole  
Overall Length: 12.5mm

UNIT PACKAGE: 25



**13170**  
(5131-1-802-258)  
Nylon

For 7mm Stud  
Fits Into 8mm Hole  
Overall Length: 20mm

UNIT PACKAGE: 50



**13150**  
(123-997-03-81)  
Nylon

For 2mm Stud  
Fits Into 4mm Hole  
Overall length: 7mm

UNIT PACKAGE: 50



**20472**  
(91512-SR3-004)  
White Nylon

Tubular Nut  
With Sealer & Sealed End  
For 3mm Stud  
Head Dia: 8.5mm  
Fits Into 6mm Hole

UNIT PACKAGE: 10



**16147**  
Nylon

For 7mm Stud  
Fits Into 8mm Hole  
Overall Length: 18mm

UNIT PACKAGE: 25



**13227**  
(113-853-615A)  
Nylon  
For 3mm Stud  
Fits Into 4mm Hole  
Overall Length: 10mm

UNIT PACKAGE: 50



**16124**  
(001-988-20-81)  
Red Nylon

For 5mm Stud  
Fits Into 9mm Hole  
Overall Length: 14mm

UNIT PACKAGE: 50



**16143**  
Zinc & Yellow  
Captivated Nut Type  
M4-.7 Thread  
Fits Into 9mm Hole  
Overall Length: 13mm

UNIT PACKAGE: 10

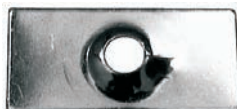

**Flat Nut**

**20652**  
(123-994-03-45)  
Zinc & Yellow

M6.5 Tapping Screw Size  
15mm x 30mm

UNIT PACKAGE: 25

**METRIC ITEMS**

**Cage Nuts**



**16142**  
Zinc & Yellow  
M6-1.0 Screw Size  
Panel Range: 1.5-2.5mm

UNIT PACKAGE: 25



**20651**  
(001-990-00-91)  
Zinc & Yellow  
M6-1.0 Screw Size  
Panel Range: .5mm - 1.7mm  
Center of Hole To Edge: 15mm

UNIT PACKAGE: 10

**“U” & “J” Nuts By Screw Size**



**20648**  
(123-994-01-45)  
Zinc & Yellow

M2.9 (#4) Screw Size  
Panel Range: .7mm - 1.5mm  
Ctr. of Hole to Edge: 4mm

UNIT PACKAGE: 50



**13217**  
(N15.422.2)  
Zinc & Yellow

4.2mm (#8) Screw Size  
Panel Range: .7mm-1.6mm  
Ctr of Hole to Edge: 7mm

UNIT PACKAGE: 25



**20650**  
Zinc & Yellow  
(123-994-08-45)

M4.2 (#8) Screw Size  
Panel Range: .5mm-2.5mm  
Ctr. of Hole to Edge: 14mm

UNIT PACKAGE: 25



**13221**  
(0712-9-925-706)  
Zinc & Yellow

2.9mm Screw Size  
Panel Range: .5mm-1.5mm  
Ctr of Hole to Edge: 6mm

UNIT PACKAGE: 50



**13223**  
(BMW: 0712-9-925-708;  
Mercedes: 000-994-25-45)  
Zinc & Yellow

4.2mm (#8) Screw Size  
Panel Range: 3mm-4mm  
Ctr of Hole to Edge: 7mm

UNIT PACKAGE: 50



**13215**  
Zinc  
& Yellow

4.8mm Screw Size  
Panel Range: .8mm-1.7mm  
Ctr of Hole to Edge: 11mm

UNIT PACKAGE: 50



**20649**  
Zinc & Yellow

M3.5 (#6) Screw Size  
Panel Range: .5mm - 1.5mm  
Ctr. of Hole to Edge: 8mm

UNIT PACKAGE: 50



**13225**  
Zinc & Yellow

4.2mm (#8) Screw Size  
Panel Range: .5mm-2.5mm  
Ctr of Hole to Edge: 8mm

UNIT PACKAGE: 50



**13218**  
Zinc & Yellow

4.8mm Screw Size  
Panel Range: .5mm-1.7mm  
Ctr of Hole to Edge: 7mm

UNIT PACKAGE: 50



**13224**  
(000-994-04-45)  
Zinc & Yellow

4.2mm (#8) Screw Size  
Panel Range: .5mm-1.7mm  
Ctr of Hole to Edge: 8mm

UNIT PACKAGE: 50



**13216**  
Zinc  
& Yellow

4.8mm Screw Size  
Panel Range: .9mm-2mm  
Center of Hole to Edge: 8mm

UNIT PACKAGE: 25

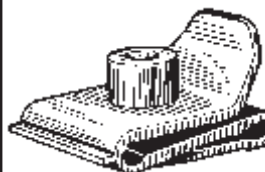

**14750**  
Black Nylon

4.8mm (#10) Screw Size  
Panel Range: Up to 1mm  
Ctr of Hole to Edge: 11mm

UNIT PACKAGE: 15

**19669**

Same As 14750 Except For Packing

UNIT PACKAGE: 25

# METRIC ITEMS

# Sec. 7



**17993**  
Black Nylon

4.8mm (#10) Screw Size  
Panel Range: Up to 3mm  
Ctr of Hole to Edge: 14mm

UNIT PACKAGE: 10



**17193**  
Nylon

5.6mm (#12) Screw Size  
Panel Range: Up to 1mm  
Ctr of Hole to Edge: 9mm

UNIT PACKAGE: 15



**14276**  
(53879-22010)  
Black Nylon

6.3mm (#14) Screw Size  
Panel Range: Up to 1mm  
Ctr of Hole to Edge: 15mm

UNIT PACKAGE: 15



**19735**  
(63848-35F00)  
Black Nylon

4.8mm (#10) Screw Size  
Panel Range: Up to 2mm  
Center Of Hole To Edge: 8mm

UNIT PACKAGE: 15

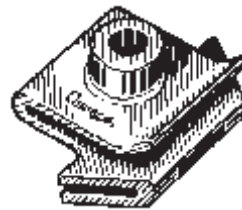

**17385**  
(63848-D4000)  
Black Nylon

5.6mm (#12) Screw Size  
Panel Range: Up to 2mm  
Ctr of Hole to Edge: 9mm

UNIT PACKAGE: 10



**13219**  
(Opel: 20-72-151;  
VW: 311-821-161)  
Zinc & Yellow

6.5mm Screw Size  
Panel Range: .7mm-1.5mm  
Ctr of Hole to Edge: 13mm

UNIT PACKAGE: 50



**13162**  
Zinc & Yellow

5.6mm Screw Size  
Pnl Range: 1.2mm-2.0mm  
Ctr of Hole to Edge: 10mm

UNIT PACKAGE: 50



**13220**  
(Mercedes: 000-994-09-14;  
Volvo: 946-418;  
Opel: 20-72-175)  
Zinc & Yellow

6.3mm (#14) Screw Size  
Pnl Range: .7mm-1.5mm  
Ctr of Hole to Edge: 13mm

UNIT PACKAGE: 50



**13222**  
(BMW: 0712-9-925-730;  
Mercedes: 000-994-50-45;  
Opel: 20-72-175;  
VW: N15.457.1)  
Zinc & Yellow

6.5mm Screw Size  
Panel Range: .7mm-1.5mm  
Ctr of Hole to Edge: 13mm

UNIT PACKAGE: 50

# Sec. 7

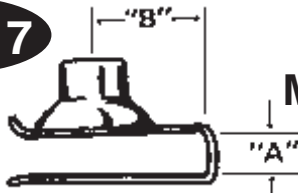

## METRIC ITEMS Metric Extruded "U" Nuts (Foldover Nuts)



Auveco Part No.	Thread Size	"A" Material Thickness		"B" Foldover Clear		Finish	O.E.M. No.	Unit Pkg.
		mm	Inches	mm	Inches			
18337	M4-.7	0.60-3.80	1/32-5/32	9.5	3/8	Phosphate	11500654, N623330-S2	50
11625	M4-.7	0.80-4.00	1/32-5/32	13.5	17/32	Phosphate	11500655	50
20339	M4.2-1.41*	0.50-2.00	1/32"-5/64"	10	25/64"	Zinc Organic	11516397	50
16841	M4.2-1.41*	2.00-3.00	5/64-1/8	9.5	3/8	Phosphate	17988147	50
18338	M5-.8	0.60-3.80	1/32-5/32	11	7/16	Phosphate	11505596, N623331-S2	50
11626	M5-.8	0.80-4.00	1/32-5/32	15.8	5/8	Phosphate	11500657	50
16846	M6-1.0*	0.80-4.00	1/32-5/32	12	15/32	Phosphate	6502152	50
16842	M6-1.0	3.40-6.30	9/64-1/4	13.5	17/32	Phosphate	11504047 N802331-S53	25
18449	M6-1.0*	0.80-4.00	1/32-5/32	13.5	17/32	Phosphate	6101308	50
11864	M6-1.0	0.80-4.00	1/32-5/32	13.5	17/32	Phosphate	11503714, 11503716	50
12669	M6-1.0	0.80-4.00	1/32-5/32	13.5	17/32	Phosphate	1016937, 11503957, N623332-S2, -S53 & S-100	25
18880	M6-1.0	3.00-4.00	1/8-5/32	13.5	17/32	Zinc Organic	21095741	50
18881	M6-1.0	3.50-4.00	9/64-5/32	13.5	17/32	Zinc Colbalt Black	21095560	10
12666	M6-1.0	1.00-5.00	3/64-13/64	14.5	9/16	Zinc Organic	11504978	25
20416	M6-1.0	2.00-5.00	5/64-3/16	14.5	9/16	Zinc Organic	11516372	25
19144	M6-1.0	3.40-6.30	9/64-1/4	19	3/4	Black Phosphate	11505048	15
12575	M6-1.0	0.34-4.00	1/64-5/32	19.5	25/32	Phosphate	11503715	25
16322	M6-1.0	1.00-2.50	3/64-3/32	19.5	25/32	Phosphate	14040999	50
19480	M6-1.0	4.30-5.60	11/64-7/32	21.0	13/16	Phosphate	N805889-S100	15
11627	M6.3-1.0	0.80-4.00	1/32-5/32	13.5	17/32	Phosphate	11502785	25
11628	M6.3-1.0	0.80-4.00	1/32-5/32	13.5	17/32	Phosphate	11500658	25
12667	M8-1.25	0.80-5.20	1-32-3/16	14.5	9/16	Zinc Organic	11503455, 11504288	25
11629	M8-1.25	0.80-4.00	1/32-5/32	14.5	9/16	Phosphate	11500660, 11502617, N623333-S2	25
11630	M8-1.25	0.80-4.50	1/32-11/64	20	13/16	Phosphate	11500661, 11503317, N623343-S2	25
19644	M8-1.25	1.70-5.50	1/16-7/32	28.5	1-1/8	Phosphate	10084751	15
19824	M8-1.25	3.90-4.40	5/32-11/64	10	25/6	Phosphate	371964	25
18401	M8-1.25*	4.00-7.00	5/32-9/32	21	13/16	Black Phosphate	N801117-S10	25
20447	M10-1.50	1.50-5.50	1/16-7/32	18	23/32	Zinc Organic	N623334-S426	10
11631	M10-1.50	1.00-6.00	3/64-15/64	19	3/4	Phosphate	11500662	25
18339	M10-1.50	1.50-5.50	1/16-7/32	19.5	25/32	Phosphate	11500663, N623344-S2	25
19901	M12-1.75	1.50-5.50	1/16-7/32	33	1-9/32	Phosphate	11515614	4
19903	M12-1.75	3.00-7.00	1/8-9/32	42	1-21/32	Phosphate	•••••	5

\*Locking Feature



# METRIC ITEMS

## Metric Flat Washers - DIN 125



**Sec. 7**

Auveco Part No.	Screw Size	I.D.	O.D.	Thickness	Finish	Unit Pkg.
10577	4mm	4.3mm	9mm	0.8mm	Zinc	50
10578	5mm	5.3mm	11mm	1mm	Zinc	50
10579	6mm	6.4mm	12mm	1.5mm	Zinc	50
17393	6mm	6.4mm	12mm	1.5mm	Zinc	100
16763	6mm	6.4mm	12mm	1.5mm	Zinc & Yellow	100
10580	7mm	7.4mm	14mm	1.5mm	Zinc	50
10581	8mm	8.4mm	17mm	2mm	Zinc	25
17394	8mm	8.4mm	17mm	2mm	Zinc	100
16764	8mm	8.4mm	17mm	1.5mm	Zinc & Yellow	100
10582	10mm	10.5mm	21mm	2mm	Zinc	25
17395	10mm	10.5mm	21mm	2mm	Zinc	100
16765	10mm	10.5mm	21mm	2mm	Zinc & Yellow	100
10583	12mm	13mm	24mm	2.5mm	Zinc	25
14632	14mm	15mm	28mm	2.5mm	Zinc	50
14633	16mm	17mm	30mm	3mm	Zinc	50
14634	20mm	21mm	37mm	3mm	Zinc	50



### Metric Lock Washers - DIN 127

Spring Steel - Zinc Plated

Auveco Part No.	Screw Size	I.D.	O.D.	Thick-ness	Unit Pkg.
10584	4mm	4.1mm	7.4mm	0.9mm	50
10585	5mm	5.1mm	9.0mm	1.2mm	50
10586	6mm	6.1mm	11.5mm	1.6mm	50
17396	6mm	6.1mm	11.5mm	1.6mm	100
10587	7mm	7.1mm	12.2mm	1.6mm	50
10588	8mm	8.2mm	14.4mm	2mm	50
17397	8mm	8.2mm	14.4mm	2mm	100
10589	10mm	10.2mm	17.5mm	2.2mm	50
17398	10mm	10.2mm	17.5mm	2.2mm	100
10590	12mm	12.2mm	20.3mm	2.5mm	25
14635	14mm	14.2mm	24.1mm	3mm	50
14636	16mm	16.2mm	27.4mm	3.5mm	50
14637	20mm	20.2mm	33.6mm	4mm	50

Do You Want Your Customers To Know You Use The Best Body Hardware & Specialty Fasteners Available?

Promotional Products And Apparel Bearing The  Logo Promote Your Identity As A Professional.



### Metric Spring Washers - DIN 137

Spring Steel - Zinc Plated

Auveco Part No.	Screw Size	I.D.	O.D.	Thick-ness	Unit Pkg.
10591	4mm	4.3mm	8mm	0.5mm	50
10592	5mm	5.3mm	10mm	0.5mm	50
10593	6mm	6.4mm	11mm	0.5mm	50
10594	7mm	7.4mm	12mm	0.5mm	50
10595	8mm	8.4mm	15mm	0.5mm	50
10596	10mm	10.5mm	18mm	0.8mm	25
10597	12mm	13mm	24mm	1.2mm	25



### Metric Copper Washers

DIN 7603

Auveco Part No.	Screw Size	I.D.	O.D.	Thick-ness	Unit Pkg.
14865	6mm	6.2mm	9.8mm	0.8mm	50
14866	8mm	8.2mm	11.8mm	0.8mm	50
14867	10mm	10.2mm	15.8mm	0.8mm	50
14868	12mm	12.2mm	17.8mm	1.4mm	25
14869	14mm	14.2mm	17.8mm	1.4mm	25
14870	14mm	14.2mm	19.8mm	1.4mm	25
14871	16mm	16.2mm	19.8mm	1.4mm	25

# Sec. 7

# METRIC ITEMS

For Actual Size Illustrations Refer to Pages 119-121



## Retaining Rings - Basic Internal DIN 472 - 1300

Groove Required In Bore  
Phosphate & Oil Finish

Auveco Part No.	Shaft Diameter		Groove Diameter		Groove Width		Unit Pkg.
	mm	Inches	mm	Inches	mm	Inches	
11486	26	1.024	27.2	1.072	1.30	.051	50
11487	28	1.104	29.4	1.158	1.30	.051	50
11488	30	1.181	31.4	1.237	1.30	.051	50
11489	32	1.260	33.7	1.328	1.30	.051	50
11490	35	1.378	37.0	1.457	1.60	.063	50
11491	40	1.575	42.5	1.675	1.85	.073	25
11492	42	1.654	44.5	1.753	1.85	.073	25
11493	47	1.850	49.5	1.950	1.85	.073	25
11494	52	2.047	55.0	2.165	2.15	.085	25
11495	62	2.441	65.0	2.559	2.15	.085	10
11496	72	2.835	75.0	2.953	2.65	.104	10
11499	100	3.937	103.5	4.078	3.15	.124	5



## Retaining Rings - Basic External DIN 471 - 1400

Groove Required On Shaft  
Phosphate & Oil Finish

Auveco Part No.	Shaft Diameter		Groove Diameter		Groove Width		Unit Pkg.
	mm	Inches	mm	Inches	mm	Inches	
11500	10.0	.394	9.6	.378	1.10	.043	100
11501	12.0	.472	11.5	.452	1.10	.043	100
11502	15.0	.591	14.3	.563	1.10	.043	100
11503	17.0	.670	16.2	.637	1.10	.043	50
11504	20.0	.787	19.0	.748	1.30	.051	50
11505	25.0	.985	23.9	.941	1.30	.051	50
11506	30.0	1.182	28.6	1.126	1.60	.063	50
11507	35.0	1.378	33.0	1.299	1.60	.063	50
11508	40.0	1.575	37.5	1.476	1.85	.073	25
11509	50.0	1.969	47.0	1.850	2.15	.085	25
11510	55.0	2.165	52.0	2.047	2.15	.085	10
11511	60.0	2.362	57.0	2.244	2.15	.085	10



## Retaining Rings - "E" Type DIN 6799 - 1500











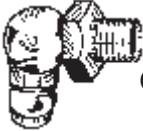

Phosphate & Oil Finish

Auveco Part No.	Shaft Diameter		Groove Diameter		Groove Width		Unit Pkg.
	mm	Inches	mm	Inches	mm	Inches	
11513	1.4	.055	1.2	.047	0.34	.0134	100
11514	2.0	.079	1.5	.059	0.44	.0173	100
11515	2.5	.098	1.9	.075	0.54	.0213	100
11516	3.0	.118	2.3	.091	0.64	.0252	100
11517	4.0	.157	3.2	.126	0.64	.0252	100
11518	5.0	.197	4.0	.157	0.74	.0291	100
11519	6.0	.236	5.0	.197	0.74	.0291	100
11520	7.0	.276	6.0	.236	0.74	.0291	100
11521	8.0	.315	7.0	.276	0.94	.0370	100
11522	9.0	.354	8.0	.315	1.05	.0413	100
11523	10.0	.394	9.0	.354	1.15	.0453	100
11524	11.0	.433	10.0	.394	1.25	.0492	100
11525	13.0	.512	12.0	.472	1.35	.0532	100
11526	16.0	.630	15.0	.591	1.55	.0610	50
11527	20.0	.787	19.0	.748	1.78	.0700	50

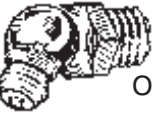

**METRIC ITEMS**  
**Metric Grease Fittings**

(Also Available In Large Bulk Quantities)

 <p>6mm-1.00, Straight DIN 71412 (VW: N185151) Overall Length: 14mm Ball Check Plated</p> <p><b>Ref No.</b> <b>8601</b></p> <p><b>11097</b> Unit Package: 5 <b>15122</b> Unit Package: 50 <b>15123</b> Unit Package: 100 <b>15426</b> Unit Package: 1000</p>	 <p>6mm-1.00, 45° Overall Length: 22mm Ball Check Plated</p> <p><b>Ref No.</b> <b>7045</b></p> <p><b>11775</b> Unit Package: 10 <b>15132</b> Unit Package: 50 <b>15133</b> Unit Package: 100 <b>15431</b> Unit Package: 1000</p>	 <p>6mm-1.00, 90° Overall Length: 18mm Ball Check Plated</p> <p><b>Ref No.</b> <b>7090</b></p> <p><b>11776</b> Unit Package: 10 <b>15134</b> Unit Package: 50 <b>15135</b> Unit Package: 100</p>
 <p>8mm-1.00, Straight DIN 71412 (VW: N185161) Overall Length: 15mm Ball Check Plated</p> <p><b>Ref No.</b> <b>8901</b></p> <p><b>11098</b> Unit Package: 5 <b>15124</b> Unit Package: 50 <b>15125</b> Unit Package: 100</p>	 <p>8mm-1.00, 45° Overall Length: 23mm Ball Check Plated</p> <p><b>Ref No.</b> <b>7445</b></p> <p><b>11777</b> Unit Package: 10 <b>15136</b> Unit Package: 50 <b>15137</b> Unit Package: 100</p>	 <p>8mm-1.00, 90° DIN 71412 (VW: N18 511 2) Overall Length: 18mm Ball Check Plated</p> <p><b>Ref No.</b> <b>7940</b></p> <p><b>11099</b> Unit Package: 5 <b>15126</b> Unit Package: 50 <b>15127</b> Unit Package: 100</p>
 <p>8mm-1.25, Straight Overall Length: 15mm Ball Check Plated</p> <p><b>Ref No.</b> <b>9201</b></p> <p><b>11778</b> Unit Package: 10 <b>15138</b> Unit Package: 50 <b>15139</b> Unit Package: 100 <b>15434</b> Unit Package: 1000</p>	 <p>8mm-1.25, 45° Overall Length: 23mm Ball Check Plated</p> <p><b>Ref No.</b> <b>7545</b></p> <p><b>11779</b> Unit Package: 10 <b>15140</b> Unit Package: 50 <b>15141</b> Unit Package: 100</p>	 <p>8mm-1.25, 90° Overall Length: 18mm Ball Check Plated</p> <p><b>Ref No.</b> <b>7590</b></p> <p><b>11780</b> Unit Package: 10 <b>15142</b> Unit Package: 50 <b>15143</b> Unit Package: 100 <b>15436</b> Unit Package: 1000</p>
 <p>10mm-1.00, Straight DIN71412 (VW: N185301) Overall Length: 15mm Ball Check Plated</p> <p><b>Ref No.</b> <b>9301</b></p> <p><b>11100</b> Unit Package: 5 <b>15128</b> Unit Package: 50 <b>15129</b> Unit Package: 100</p>	 <p>10mm-1.00, 45° Overall Length: 23mm Ball Check Plated</p> <p><b>Ref No.</b> <b>9345</b></p> <p><b>15067</b> Unit Package: 25 <b>15098</b> Unit Package: 100 <b>15099</b> Unit Package: 250</p>	 <p>10mm-1.00, 90° DIN 71412 (VW: N18 510 1) Overall Length: 19mm Ball Check Plated</p> <p><b>Ref No.</b> <b>9390</b></p> <p><b>11101</b> Unit Package: 5 <b>15130</b> Unit Package: 50 <b>15131</b> Unit Package: 100 <b>15430</b> Unit Package: 1000</p>
 <p>10mm-1.5 Straight Overall Length: 15mm Ball Check</p> <p><b>Ref No.</b> <b>9501</b></p> <p><b>17555</b> Unit Package: 50</p>	<p align="center"><b>Stainless Steel Metric Grease Fittings Are Listed On The Next Page.</b></p>	

**Sec. 7**

**METRIC ITEMS**

**Stainless Steel Grease Fittings With Ball Check**

303 Series Body • 420 Series Ball • 302 Series Spring



**17155**

Ref. No. 8036

6mm-1.0, Straight  
Overall Length: 14mm

UNIT PACKAGE: 5

Please Order  
In Unit Package Quantity  
Not Pieces



**17156**

Ref. No. 8058

8mm-1.00, Straight  
Overall Length: 15mm

UNIT PACKAGE: 5



**17680**

Ref. No. 5890

8mm-1.00, 90°  
Overall Length: 17.8mm

UNIT PACKAGE: 5

**For Additional Grease Fittings Refer To Pages 222-225**



Concave Type

**Metric Expansion Plugs**

Zinc Plated



Cup Type

Auveco Part No.	Size	Type	Unit Pkg.
11876	18.0mm	Cup	25
11877	20.0mm	Cup	25
11878	22.0mm	Cup	25
11879	25.0mm	Cup	25
11881	30.0mm	Cup	25
11884	35.0mm	Cup	10
11886	38.0mm	Cup	10
11888	40.3mm	Cup	10
11892	44.0mm	Cup	10
11893	45.0mm	Cup	10
11895	49.5mm	Cup	10
11896	50.0mm	Cup	10
11899	35.0mm	Concave	25
11901	42.0mm	Concave	10
11902	45.0mm	Concave	10

**Metric Cotter Pins**



DIN 94 • Steel

Auveco Part No.	Diameter	Length	Unit Pkg.
10552	2mm	15mm	100
10553	2mm	18mm	100
10554	2mm	20mm	100
10555	2mm	22mm	100
10556	2.5mm	25mm	100
10557	3.2mm	20mm	100
10558	3mm	25mm	100
10559	3mm	30mm	100
10560	3mm	35mm	50
10562	4mm	30mm	50
10563	4mm	35mm	50
10564	4mm	40mm	50
10565	5mm	30mm	25
10566	5mm	35mm	25
10567	5mm	40mm	25
10568	5mm	45mm	25
14641	5mm	60mm	25

For an assortment of Metric Cotter Pins, see Fix-Kit No. 6158 in the green pages.

**METRIC OIL DRAIN PLUGS**

Refer to the Oil Drain Plugs Listing in the Index.

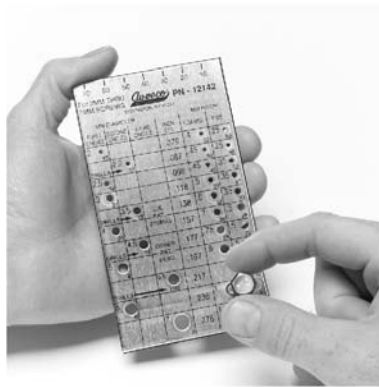

**Metric Screw Checker  
12142**

For I.S.O. Metric Screws From  
2mm (0.079")  
Thru 7mm (0.276")

UNIT PACKAGE: 1

**Includes**

Instructions for use and cutting, straighten, cleaning screws, Metric/Fractional conversion chart (0.01-47mm), Metric/English Conversion chart for length, area, mass, volume, temperature. Complete listing of all I.S.O. Metric screw sizes

**Metric Screw Checker  
12143**

For I.S.O. Metric Screws  
From 8mm (0.315")  
Thru 14mm (0.551")

UNIT PACKAGE: 1

**Tells**

Length in millimeters & inches  
Tap series  
I.S.O. preference rating  
Size (in millimeters)  
Pitch (in millimeters)  
Clearance drill size  
Tap Drill Size  
Basic Diameter (in inches)

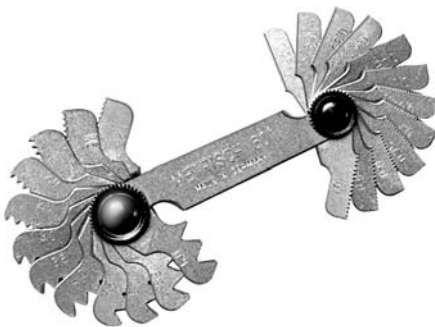

**7955**

Metric Screw Pitch Gauge:  
Pitch Capacity 0.25 to 6mm  
24 Blades

UNIT PACKAGE: 1

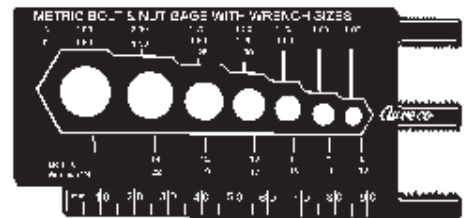

**14770**

Metric Bolt & Nut Gauge

Determine the diameter of the bolts by pushing them thru the holes. Measure the hex head of bolts & screws or the "across the flat" dimension of hex nuts in the recesses around the holes (listed as wrench size). Right-hand side of tool measures thread pitch (1.00, 1.50, 1.75 & 2.00)

**Thread Pitches**

**Approximate Threads Per Inch For Metric Screws, Bolts and Nuts**

Diameter in mm	3	4	5	6	7	8	10	12	14	16
Diameter in Inch	.118	.157	.197	.236	.276	.315	.394	.472	.551	.630
Standard Pitch mm	.5	.7	.8	1.0	1.0	1.25	1.5	1.75	2.0	2.0
Approx. Threads/Inch	51	36	32	25	25	20	17	14	12	12
Fine Pitch mm						1.0	1.25	1.5	1.5	1.5
Approx Threads. Inch						25	20	17	17	17
Extra Fine Pitch mm							1.0	1.25	1.25	1.25
Approx. Threads/Inch							25	20	20	20

**METRIC ITEMS**

**Inch Fractions And Decimals To Metric Equivalents**

Inches			Inches			Inches		
Fractions	Decimals	mm	Fractions	Decimals	mm	Fractions	Decimals	mm
_____	.0004	.01	15/32	.46875	11.906	_____	1.063	27
_____	.004	.10	_____	.4724	12	1-3/32	1.094	27.781
_____	.01	.25	31/64	.48437	12.303	_____	1.1024	28
1/64	.0156	.397	_____	.492	12.5	1-1/8	1.125	28.575
_____	.0197	.50	1/2	.500	12.700	_____	1.1417	29
_____	.0295	.75	_____	.5118	13	1-5/32	1.156	29.369
1/32	.03125	.794	33/64	.5156	13.097	_____	1.1811	30
_____	.0394	1	17/32	.53125	13.494	1-3/16	1.1875	30.163
3/64	.0469	1.191	35/64	.54687	13.891	1-7/32	1.219	30.956
_____	.059	1.5	_____	.5512	14	_____	1.2205	31
1/16	.0625	1.588	9/16	.5625	14.288	1-1/4	1.250	31.750
5/64	.0781	1.984	_____	.571	14.5	_____	1.2598	32
_____	.0787	2	37/64	.57812	14.684	1-9/32	1.281	32.544
3/32	.094	2.381	_____	.5906	15	_____	1.2992	33
_____	.0984	2.5	19/32	.59375	15.081	1-5/16	1.312	33.338
7/64	.1093	2.776	39/64	.60937	15.478	_____	1.3386	34
_____	.1181	3	5/8	.6250	15.875	1-11/32	1.344	34.131
1/8	.1250	3.175	_____	.6299	16	1-3/8	1.375	34.925
_____	.1378	3.5	41/64	.6406	16.272	_____	1.3779	35
9/64	.1406	3.572	_____	.6496	16.5	1-13/32	1.406	35.719
5/32	.15625	3.969	21/32	.65625	16.669	_____	1.4173	36
_____	.1575	4	_____	.6693	17	1-7/16	1.438	36.513
11/64	.17187	4.366	43/64	.67187	17.066	_____	1.4567	37
_____	.177	4.5	11/16	.6875	17.463	1-15/32	1.469	37.306
3/16	.1875	4.763	45/64	.7031	17.859	_____	1.4961	38
_____	.1969	5	_____	.7087	18	1-1/2	1.500	38.100
13/64	.2031	5.159	23/32	.71875	18.256	1-17/32	1.531	38.894
_____	.2165	5.5	_____	.7283	18.5	_____	1.5354	39
7/32	.21875	5.556	47/64	.73437	18.653	1-9/16	1.562	39.688
15/64	.23437	5.953	_____	.7480	19	_____	1.5748	40
_____	.2362	6	3/4	.7500	19.050	1-19/32	1.594	40.481
1/4	.2500	6.350	49/64	.7656	19.447	_____	1.6142	41
_____	.2559	6.5	25/32	.78125	19.844	1-5/8	1.625	41.275
17/64	.2656	6.747	_____	.7874	20	_____	1.6535	42
_____	.2756	7	51/64	.79687	20.241	1-21/32	1.6562	42.069
9/32	.28125	7.144	13/16	.8125	20.638	1-11/16	1.6875	42.863
_____	.2953	7.5	_____	.8268	21	_____	1.6929	43
19/64	.29687	7.541	53/64	.8281	21.034	1-21/32	1.719	43.656
5/16	.3125	7.938	27/32	.84375	21.431	_____	1.7323	44
_____	.3150	8	55/64	.85937	21.828	1-3/4	1.750	44.450
21/64	.3281	8.334	_____	.8662	22	_____	1.7717	45
_____	.335	8.5	7/8	.8750	22.225	1-25/32	1.781	45.244
11/32	.34375	8.731	57/64	.8906	22.622	_____	1.8110	46
_____	.3543	9	_____	.9055	23	1-13/16	1.8125	46.038
23/64	.35937	9.128	29/32	.90625	23.019	1-27/32	1.844	46.831
_____	.374	9.5	59/64	.92187	23.416	_____	1.8504	47
3/8	.3750	9.525	15/16	.9375	23.813	1-7/8	1.875	47.625
25/64	.3906	9.922	_____	.9449	24	_____	1.8898	48
_____	.3937	10	61/64	.9531	24.209	1-29/32	1.9062	48.419
13/32	.4062	10.319	31/32	.96875	24.606	_____	1.9291	49
_____	.413	10.5	_____	.9843	25	1-15/16	1.9375	49.213
27/64	.42187	10.716	1	1.000	25.4	_____	1.9685	50
_____	.4331	11	_____	1.0236	26	1-31/32	1.969	50.006
7/16	.4375	11.113	1-1/32	1.0312	26.194	2	2.000	50.800
29/64	.4531	11.509	1-1/16	1.062	26.988	_____	2.0079	51

# METRIC ITEMS

## Inch Fractions And Decimals To Metric Equivalents

Inches			Inches			Inches		
Fractions	Decimals	mm	Fractions	Decimals	mm	Fractions	Decimals	mm
—	2.0472	52	—	3.1102	79	—	4.3307	110
2-1/16	2.062	52.388	3-1/8	3.125	79.375	4-3/8	4.375	111.125
—	2.0866	53	—	3.1496	80	4-7/16	4.438	112.713
2-1/8	2.125	53.975	3-3/16	3.1875	80.963	4-1/2	4.500	114.300
—	2.126	54	—	3.1890	81	—	4.5275	115
—	2.165	55	—	3.2283	82	4-9/16	4.562	115.888
2-3/16	2.1875	55.563	3-1/4	3.250	82.550	4-5/8	4.625	117.475
—	2.2047	56	—	3.2677	83	—	4.7244	120
—	2.244	57	—	3.3071	84	4-3/4	4.750	120.650
2-1/4	2.250	57.150	3-5/16	3.312	84.1377	4-7/8	4.875	123.825
—	2.2835	58	—	3.3464	85	—	4.9212	125
2/5-16	2.312	58.738	3-3/8	3.375	85.725	5	5.000	127
—	2.3228	59	—	3.3858	86	—	5.1181	130
—	2.3622	60	—	3.4252	87	5-1/4	5.250	133.350
2-3/8	2.375	60.325	3-7/16	3.438	87.313	5-1/2	5.500	139.700
—	2.4016	61	—	3.4646	88	—	5.5118	140
2-7/16	2.438	61.913	3-1/2	3.500	88.900	5-3/4	5.750	146.050
—	2.4409	62	—	3.5039	89	—	5.9055	150
—	2.4803	63	—	3.5433	90	6	6.00	152.400
2-1/2	2.500	63.500	3-9/16	3.562	90.4877	6-1/4	6.250	158.750
—	2.5197	64	—	3.5827	91	—	6.2992	160
—	2.559	65	—	3.622	92	6-1/2	6.500	165.100
2-9/16	2.562	65.088	3-5/8	3.625	92.075	—	6.6929	170
—	2.5984	66	—	3.6614	93	6-3/4	6.750	171.450
2-5/8	2.625	66.675	3-11/16	3.6875	93.663	7	7.000	177.800
—	2.638	67	—	3.7008	94	—	7.0866	180
—	2.6772	68	—	3.7401	95	—	7.4803	190
2-11/16	2.6875	68.263	3-3/4	3.750	95.250	7-1/2	7.500	190.500
—	2.7165	69	—	3.7795	96	—	7.8740	200
2-3/4	2.750	69.850	3-13/16	3.8125	96.838	8	8.000	203.200
—	2.7559	70	—	3.8189	97	—	8.2677	210
—	2.7953	71	—	3.8583	98	8-1/2	8.500	215.900
2-13/16	2.8125	71.438	3-7/8	3.875	98.425	—	8.6614	220
—	2.8346	72	—	3.8976	99	9	9.000	228.600
—	2.8740	73	—	3.9370	100	—	9.0551	230
2-7/8	2.875	73.025	3-15/16	3.9375	100.013	—	9.4488	240
—	2.9134	74	—	3.9764	101	9-1/2	9.500	241.300
2-15/16	2.9375	74.613	4	4.000	101.600	—	9.8425	250
—	2.9527	75	4-1/16	4.062	103.188			
—	2.9921	76	4-1/8	4.125	104.775			
3	3.000	76.200	—	4.1338	105			
—	3.0315	77	4-3/16	4.1875	106.363			
3-1/16	3.062	77.788	4-1/4	4.250	107.950			
—	3.0709	78	4-5/16	4.312	109.538			

U.S. STANDARD GAUGE CHART							
Gauge	Decimal Size	Gauge	Decimal Size	Gauge	Decimal Size	Gauge	Decimal Size
7	.188"	14	.078"	21	.034"	28	.016"
8	.172"	15	.070"	22	.031"	29	.014"
9	.156"	16	.063"	23	.028"	30	.013"
10	.141"	17	.056"	24	.025"	31	.011"
11	.125"	18	.050"	25	.022"		
12	.109"	19	.044"	26	.019"		
13	.094"	20	.038"	27	.017"		

# Sec. 8

# NUTS

## Prevailing Torque Locknuts



Grade 8 • Cad and Waxed

Auveco Part No.	Thread Size	Hex Width	Unit Pkg.
12697	1/4"-20 USS	7/16"	50
12705	1/4"-28 SAE	7/16"	50
12698	5/16"-18 USS	1/2"	50
12706	5/16"-24 SAE	1/2"	50
12699	3/8"-16 USS	9/16"	50
12707	3/8"-24 SAE	9/16"	50
12700	7/16"-14 USS	11/16"	50
12708	7/16"-20 SAE	11/16"	50
12701	1/2"-13 USS	3/4"	25
12709	1/2"-20 SAE	3/4"	25
12702	9/16"-12 USS	7/8"	25
12710	9/16"-18 SAE	7/8"	25
12703	5/8"-11 USS	15/16"	10
12711	5/8"-18 SAE	15/16"	10
12704	3/4"-10 USS	1-1/8"	10
12712	3/4"-16 SAE	1-1/8"	10
16472	7/8"-14 SAE	1-9/32"	10
16473	1"-8 USS	1-15/32"	5

## Hexagon Machine Screw Nuts

Double Chamfered - Plain Brass



Auveco Part No.	Thread Size	Hex Width	Unit Pkg.
3866	6-32	5/16"	100
3867	8-32	11/32"	100
3868	10-24 USS	3/8"	100
3869	10-32 SAE	3/8"	100
3870	12-24 USS	7/16"	100
3871	1/4"-20 USS	7/16"	100
3875	3/8"-16 USS	5/8"	100

## Slotted Hex Nuts

Zinc Finish



Auveco Part No.	Thread Size	Hex Width	Slot Width	Unit Pkg.
12722	1/2"-20	3/4"	5/32"-3/16"	50
12723	5/8"-18	15/16"	3/16"-15/64"	25

## Hexagon Machine Screw Nuts



Auveco Part No.	Thread Size	Hex Width	Unit Pkg.
-----------------	-------------	-----------	-----------

Zinc Plated Steel

727	6-32	5/16"	100
728	8-32	11/32"	100
729	10-32	3/8"	100
730	10-24	3/8"	100
731	12-24	7/16"	100
733	1/4"-20	7/16"	100

## Nylon Insert Lock Nuts



Grade 2  
Zinc Plated

Auveco Part No.	Thread Size	Hex Width	Unit Pkg.
9535	8-32	11/32"	100
9536	10-24 USS	3/8"	100
9537	10-32 SAE	3/8"	100
9538	12-24	7/16"	100
9539	1/4"-20 USS	7/16"	100
9540	1/4"-28 SAE	7/16"	100
9541	5/16"-18 USS	1/2"	50
9542	5/16"-24 SAE	1/2"	50
9543	3/8"-16 USS	9/16"	50
9544	3/8"-24 SAE	9/16"	50
9545	7/16"-14 USS	5/8"	50
9546	7/16"-20 SAE	5/8"	50
9547	1/2"-13 USS	3/4"	50
9548	1/2"-20 SAE	3/4"	50
15863	5/8"-11 USS	15/16"	25
15864	5/8"-18 SAE	15/16"	25
15865	3/4"-10 USS	1-1/8"	25

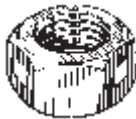

## Reversible Lock Nuts

Grade 2  
Zinc Plated

Auveco Part No.	Thread Size	Hex Width	Unit Pkg.
11740	1/4"-20	7/16"	100
11741	5/16"-18	1/2"	100
11742	3/8"-16	9/16"	50
11743	1/2"-13	3/4"	25
11744	5/8"-11	15/16"	25

## Finished USS (Coarse) & SAE (Fine) Hexagon Nuts Zinc Plated

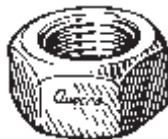

Auveco Part No.	Thread Size	Hex Width	Unit Pkg.	Auveco Part No.	Thread Size	Hex Width	Unit Pkg.
<b>3541</b>	1/4"-20 USS	7/16"	100	<b>3549</b>	1/2"-13 USS	3/4"	100
<b>3542</b>	1/4"-28 SAE	7/16"	100	<b>3550</b>	1/2"-20 SAE	3/4"	100
<b>3543</b>	5/16"-18 USS	1/2"	100	<b>8659</b>	9/16"-12 USS	7/8"	50
<b>3544</b>	5/16"-24 SAE	1/2"	100	<b>8660</b>	9/16"-18 SAE	7/8"	50
<b>3545</b>	3/8"-16 USS	9/16"	100	<b>8661</b>	5/8"-11 USS	15/16"	50
<b>3546</b>	3/8"-24 SAE	9/16"	100	<b>8662</b>	5/8"-18 SAE	15/16"	50
<b>3547</b>	7/16"-14 USS	11/16"	100	<b>8663</b>	3/4"-10 USS	1-1/8"	50
<b>3548</b>	7/16"-20 SAE	11/16"	100	<b>8664</b>	3/4"-16 SAE	1-1/8"	50

## Grade 5 Finished USS (Coarse) & SAE (Fine) Hex Nuts



Fully Certified For  
S.A.E. J995 Standard  
Proof Load: 120,000 PSI  
C32 Max. Rockwell Hardness  
Zinc Plated

Auveco Part No.	Thread Size	Hex Width	Unit Pkg.	Auveco Part No.	Thread Size	Hex Width	Unit Pkg.
<b>15586</b>	1/4"-20 USS	7/16"	100	<b>15599</b>	1/2"-20 SAE	3/4"	50
<b>15595</b>	1/4"-28 SAE	7/16"	100	<b>16981</b>	9/16"-12 USS	7/8"	25
<b>15587</b>	5/16"-18 USS	1/2"	100	<b>15591</b>	5/8"-11 USS	15/16"	25
<b>15596</b>	5/16"-24 SAE	1/2"	100	<b>15600</b>	5/8"-18 SAE	15/16"	25
<b>15588</b>	3/8"-16 USS	9/16"	100	<b>15592</b>	3/4"-10 USS	1-1/8"	25
<b>15597</b>	3/8"-24 SAE	9/16"	100	<b>15601</b>	3/4"-16 SAE	1-1/8"	25
<b>15589</b>	7/16"-14 USS	11/16"	50	<b>15593</b>	7/8"-9 USS	1-9/32"	10
<b>15598</b>	7/16"-20 SAE	11/16"	50	<b>15594</b>	1"-8 USS	1-15/32"	10
<b>15590</b>	1/2"-13 USS	3/4"	50				

**Sec. 8**

**Finished USS (Coarse) & SAE (Fine) Hexagon Nuts**

Zinc & Yellow Plated  
High Alloy  
Grade 8

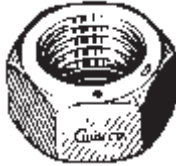

**NUTS**

**Grade 8**  
Finished USS (Coarse) & SAE (Fine) Hex Nuts

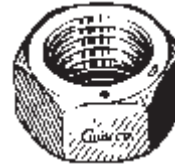

Fully Certified  
Proof Load: 150,000 PSI  
C24-C32 Max. Rockwell Hardness For 1/4 thru 5/8  
C26-C34 Max. Rockwell Hardness For 3/4 thru 1  
Zinc & Yellow Plated

Auveco Part No.	Thread Size	Hex Width	Unit Pkg.	Auveco Part No.	Thread Size	Hex Width	Unit Pkg.
9300	1/4"-20 USS	7/16"	100	15640	1/4"-20 USS	7/16"	100
9307	1/4"-28 SAE	7/16"	100	15649	1/4"-28 SAE	7/16"	100
9301	5/16"-18 USS	1/2"	100	15641	5/16"-18 USS	1/2"	100
9308	5/16"-24 SAE	1/2"	100	15650	5/16"-24 SAE	1/2"	100
9302	3/8"-16 USS	9/16"	100	15642	3/8"-16 USS	9/16"	100
9309	3/8"-24 SAE	9/16"	100	15651	3/8"-24 SAE	9/16"	100
9303	7/16"-14 USS	11/16"	50	15643	7/16"-14 USS	11/16"	50
9310	7/16"-20 SAE	11/16"	50	15652	7/16"-20 SAE	11/16"	50
9304	1/2"-13 USS	3/4"	50	15644	1/2"-13 USS	3/4"	50
9311	1/2"-20 SAE	3/4"	50	15653	1/2"-20 SAE	3/4"	50
9305	5/8"-11 USS	15/16"	25	16983	9/16"-12 USS	7/8"	25
9312	5/8"-18 SAE	15/16"	25	15645	5/8"-11 USS	15/16"	25
9306	3/4"-10 USS	1-1/8"	25	15654	5/8"-18 SAE	15/16"	25
13759	1"-8 USS	1-15/32"	10	15646	3/4"-10 USS	1-1/8"	15
				15655	3/4"-16 SAE	1-1/8"	15
				15647	7/8"-9 USS	1-9/32"	10

Refer to Assortments 1020, 1021, 1030 & 1031 in the green pages.



**Display Boards  
Are Great Selling Tools.  
Use Them To Help Boost  
Your Sales.  
Refer To The Color Pages  
At The Front Of The  
Catalog.**

Do You Want Your Customers To  
Know You Use The Best Body  
Hardware & Specialty Fasteners  
Available?

Promotional Products And  
Apparel Bearing The  Logo  
Promote Your Identity As A  
Professional.



# NUTS



## Brass Cylinder Head And Manifold Stud Nuts

Auveco Part No. USS	Auveco Part No. SAE	Thread Size	Hex Width	Height	Unit Pkg.
5314	5315	1/4"	7/16"	7/32"	50
5317	5316	5/16"	1/2"	17/64"	50
5319	5318	3/8"	9/16"	21/64"	50
5320		3/8"	9/16"	5/8"	25
5325	5324	1/2"	3/4"	7/16"	25



## Keps® Lock Washer & Nut Zinc Plated

Auveco Part No.	Thread Size	Hex Width	Unit Pkg.
3492	6-32	5/16"	100
3493	8-32	11/32"	100
3494	10-24	3/8"	100
3495	10-32	3/8"	100
3496	1/4"-20	7/16"	100
3497	1/4"-28	7/16"	100
3498	5/16"-18	1/2"	100
3499	5/16"-24	1/2"	100
3500	3/8"-16	9/16"	100
3501	3/8"-24	9/16"	100



## Ziptwist Wing Nut

Auveco Part No.	Thread Size	O.D.	Height	Finish	Unit Pkg.
18531	6mm	5/8"	7/32"	Black	50



## Washer Base Wing Nuts Zinc Alloy Nickel Plated

Auveco Part No.	Size	Wing Spread	Overall Height	Washer O.D.	Unit Pkg.
10036	1/4"-20	1"	1/2"	3/4"	50



## Square Nuts

Auveco Part No.	Thread Size	Width	Finish	Unit Pkg.
3249	3/16"-24	3/8"	Bright Zinc	100
3250	1/4"-20	7/16"	Bright Zinc	100

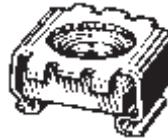

## Cage Nuts Phosphate Plated

Auveco Part No.	Thread Size	Fits Sq. Hole	Panel Range	Unit Pkg.
3144	1/4"-20	3/8"	.064-.105"	50
10773	1/4"-20	3/8"	.064-.105"	25
3798	5/16"-18	1/2"	.023-.063"	50



## Spin Lock Nuts With Serrations



Auveco Part No.	Thread Size	Flange O.D.	Hex Width	Unit Pkg.
-----------------	-------------	-------------	-----------	-----------

### Standard Flange - Zinc Plated

14878	8-32"	15/32"	11/32"	100	
14873	10-24"	USS	1/2"	3/8"	100
14874	1/4"-20	USS	19/32"	7/16"	100
14875	5/16"-18	USS	11/16"	1/2"	100
14876	3/8"-16	USS	3/4"	9/16"	100
14877	7/16"-14	USS	15/16"	11/16"	50
17084	1/2"-13	USS	1"	3/4"	25

### Large Flange - Black Phosphate

2769	1/4"-20	USS	11/16"	7/16"	100
5167	5/16"-18	USS	13/16"	1/2"	100
5596	3/8"-16	USS	7/8"	9/16"	100



## Wing Nuts Nickel Plated

Auveco Part No.	Size	Unit Pkg.
3741	1/4"-20	100
3743	3/8"-16	50



## Self-Locking Wing Nuts Bright Zinc Chromate

Auveco Part No.	Size	Unit Pkg.
9846	1/4"-20	100

# Sec. 8

# NUTS

## Free Spinning Washer Nuts



Auveco Part No.	Thread Size	Washer O.D.	Hex Size	Height	Plating	O.E.M. No.	Unit Pkg
15338	#8-32	3/8"	11/32"	5/32"	Zinc & Yellow	383693	100
16770	#10-24	3/8"	5/16"	11/64"	Zinc & Yellow	383255-S36	100
15342	#10-24	9/16"	3/8"	5/16"	Phosphate	6025002	50
16771	#10-32	3/8"	5/16"	11/64"	Zinc & Yellow		100
16772	1/4"-20	1/2"	7/16"	3/16"	Zinc		50
15345	1/4"-20	5/8"	7/16"	9/32"	Zinc & Yellow	3866846, 385400	50
15347	1/4"-20	7/8"	7/16"	5/16"	Phosphate	45334, 6023204, 6025004	50
16773	1/4"-28	1/2"	7/16"	3/16"	Zinc	6022582T50	
15350	5/16"-18	3/4"	1/2"	3/8"	Phosphate	6025007	50
15351	3/8"-16	7/8"	9/16"	7/16"	Phosphate	376785	25

For metric sizes of free spinning washer nuts, refer to page 64.

### Pushnut Bolt Retainers

For Threaded Fasteners



Auveco Part No.	Bolt Dia.	O.D.	Finish	Unit Pkg.
16851	9/64" (#6)	11/32"	Zinc	100
10085	5/32" (#8)	3/8"	Phos	100
16852	3/16" (#10)	7/16"	Phos	100
10086	1/4"	1/2"	Zinc	100
10087	5/16"	5/8"	Zinc	100
9297	3/8"	25/32"	Zinc	100
9298	7/16"	27/32"	Zinc	100
9299	1/2"	15/16"	Zinc	100

For an Assortment of Pushnut Bolt Retainers see Fit-Kit No. 6164



### Washer Lock Nuts

Zinc Plated

Auveco Part No.	Thread Size	Hex Width	O.D.	Unit Pkg.
2554	6-32	5/16"	7/16"	100
2555	8-32	11/32"	15/32"	100
2556	10-32	3/8"	1/2"	100
2557	10-24	3/8"	1/2"	100
2558	10-24	3/8"	3/4"	100
2560	12-24	3/8"	3/4"	100
2561	1/4"-20	7/16"	19/32"	100
2562	1/4"-20	7/16"	13/16"	100
10764	5/16"-18	1/2"	13/16"	100

For an assortment of Washer Lock Nuts, see Fix-Kit 6043



### Flat Push-On Retainers

For Non-Threaded Fasteners

Auveco Part No.	Stud Size	O.D.	Plating	Unit Pkg.
8861	1/16"	3/16"	Phos	100
8862	3/32"	3/16"	Phos	100
8863	1/8"	3/8"	Zinc	100
8864	5/32"	7/16"	Zinc	100
8865	3/16"	7/16"	Zinc	100
8866	.237"	3/4"	Phos	100
8867	.240"	17/32"	Zinc	100
8868	1/4"	17/32"	Zinc	100
8869	5/16"	5/8"	Zinc	100
10374	3/8"	3/4"	Zinc	100
10375	1/2"	1"	Zinc	100



### Hex Pal Nuts

Plated

Auveco Part No.	Thread Size	Hex Width	Unit Pkg.
3975	3/8"-24	9/16"	100
8858	1/2"-20	3/4"	100

# THREAD CUTTING NUTS

**Sec. 8**

 <p><b>3400</b> Zinc 1/8" Stud Size 1/4" Hex UNIT PACKAGE: 200</p>	 <p><b>2896</b> Zinc 3/16" Stud Size 3/8" Hex 5/8" Washer Diameter UNIT PACKAGE: 100</p>	 <p><b>8855</b> Zinc 5/32" Stud Size 11/32" Hex 9/16" Washer Diameter UNIT PACKAGE: 100</p>	 <p><b>12261</b> (376842-F100) Zinc 1/4" Stud Size 7/16" Hex 19/32" Washer Diameter With Sealer UNIT PACKAGE: 50</p>
 <p><b>3401</b> Zinc 1/8" Stud Size 5/16" Hex UNIT PACKAGE: 200</p>	 <p><b>2897</b> Zinc 1/4" Stud Size 7/16" Hex 19/32" Washer Diameter UNIT PACKAGE: 100</p>	 <p><b>3405</b> Zinc 1/4" Stud Size 7/16" Hex 11/16" Washer Diameter UNIT PACKAGE: 200</p>	 <p><b>10733</b> Zinc 5/16" Stud Size 1/2" Hex 7/8" Washer Diameter UNIT PACKAGE: 100</p>
 <p><b>3402</b> Zinc 3/16" Stud Size 1/2" Hex UNIT PACKAGE: 200</p>	 <p><b>3403</b> Zinc 1/8" Stud Size 5/16" Hex 7/16" Washer Diameter UNIT PACKAGE: 200</p>	 <p><b>10669</b> (9420262) Zinc 1/4" Stud Size 7/16" Hex 11/16" Washer Diameter With Sealer UNIT PACKAGE: 100</p>	<p><b>For an assortment of Thread Cutting Nuts, see Fix-Kit 6043.</b></p>
 <p><b>2895</b> Zinc 1/8" Stud Size 5/16" Hex 17/32" Washer Diameter UNIT PACKAGE: 100</p>	 <p><b>3404</b> Zinc 3/16" Stud Size 3/8" Hex 1/2" Washer Diameter UNIT PACKAGE: 200</p>		



## Acorn Cap Nuts Nickel Plated

Auveco Part No.	Thread Size	Hex Width	Height	Unit Pkg.
11179	8-32	5/16"	9/32"	100
11180	10-24	3/8"	11/32"	100
11181	10-32	3/8"	11/32"	100
11182	1/4"-20	7/16"	3/8"	50
11183	5/16"-18	9/16"	7/16"	50
11184	3/8"-16	5/8"	1/2"	25
11185	1/2"-13	3/4"	9/16"	25

For Nylon Coated Metric Acorn Nuts, refer to page 65.

**Do You Want Your Customers To Know You Use The Best Body Hardware & Specialty Fasteners Available?**

**Promotional Products And Apparel Bearing The  Logo Promote Your Identity As A Professional.**

**WHEEL STUDS & BOLTS**

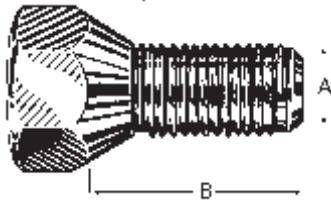

Type #1

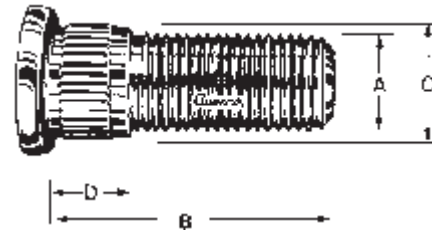

Type #2

Plated • Grade 8 Steel

UNIT PACKAGE: 10

Auveco No.	Type	Diameter (A)	Length (B)	Knurl Dia. (C)	Shoulder Length (D)	Application
14225	1	1/2"-20	1.070"/1.100"	N/A	N/A	Universal (3/4" Hex)
14226	1	9/16"-18	1.070"/1.100"	N/A	N/A	Universal (3/4" Hex)
14227	2	1/2"-20	1.510"/1.540"	.618"/.628"	.310"/.330"	GM 76-55: Int. 80-67
14228	2	7/16"-20	1.380"/1.410"	.556"/.566"	.300"/.320"	GM 51-On
14229	2	7/16"-20	1.330"/1.350"	.556"/.566"	.520"/.540"	Dodge & Olds 72-65
14231	2	1/2"-20	1.615"/1.635"	.618"/.628"	.440"/.460"	Ford 62-On
14235	2	1/2"-20	1.620"/1.650"	.618"/.628"	.630"/.650"	Dodge Tk 82-69; Ford 72-65; GMC 70-60
14237	2	1/2"-20	1.435/1.465"	.556"/.566"	.420"/.440"	Ford 75-73
14238	2	1/2"-20	1.610"/1.640"	.618"/.628"	.660"/.680"	Chrysler 86-81
14241	2	7/16"-20	1.470"/1.500"	.460"/.470"	.333"/.343"	Chrysler 76-64; GM 84-62; Jeep 82-74
14243	2	1/2"-20	1.610"/1.640"	.618"/.628"	.545"/.555"	AMC 76-75; Chrysler 86-74
14244	2	1/2"-20	1.720"/1.750"	.615"/.625"	.445"/.460"	Ford 75-On
14250	2	12mm-1.5	41.3/42.0mm	12.57/12.83mm	9.4/9.7mm	GM 79-On
14251	2	1/2"-20	1.720"-1.750"	.610"/.620"	.445"/.460"	Escort & Lynx 83-81

# WHEEL NUTS



Type 1 (Outer)

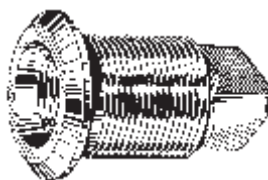

Type 2 (Inner)



Type 3  
(Stainless Steel Cap)



Type 4  
(Stainless Steel Cap)



Type 5



Type 6  
(Stainless Steel Cap)

Part No.	Unit Pkg.	Type	Size	Height	Hex	O.E.M. No.
8742	50	1	1/2"-20	9/16"	3/4"	Chrys: 2409826
8744	50	1	1/2"-20	5/8"	13/16"	GM: 413945, Ford: C0AZ-1012A
8746	50	1	7/16"-20	9/16"	3/4"	GM: 516637, Chrys: 2072728
11715	5	3	1/2"-20	1-1/16"	13/16"	GM: 414187
12520	5	2	3/4"-16 L.H. (Inner) 1-1/8"-16 L.H. (Outer)	2-7/32"	13/16" Sq.	Budd: 10709
12521	5	1	1-1/8"-16 L.H.	7/8"	1-1/2"	Budd: 37892
12522	5	2	3/4"-16 (Inner) R.H. 1-1/8"-16 (Outer) R.H.	2-7/32"	13/16" Sq.	Budd: 10708
12523	5	1	1-1/8"-16	7/8"	1-1/2"	Budd: 37891
12524	5	1	3/4"-16 L.H.	7/8"	1-1/2"	Budd: 37889
12525	5	1	3/4"-16	7/8"	1-1/2"	Budd: 37888
12617	5	5	12mm-1.5	23mm	19mm	Chrys: 6500092
12675	25	1	12mm-1.5	14mm	19mm	GM: 9590477
12695	5	4	12mm-1.5	34mm	19mm	GM: 10018202
12715	10	1	12mm-1.5	14mm	19mm	Chrys: 6500526
14253	10	1	12mm-1.25	16mm	21mm	Nissan: 40224-21001
17353	5	6	12mm-1.5	30mm	19mm	Chry: 6502738
18163	5	4	1/2"-20	1-11/32"	3/4"	Chrys: J4006956
19168	10	6	7/16"-20	1-3/32"	3/4"	GM: 414188, 9591855



## Drum Retaining Speed Nuts®

14390.....7/16"-20 .....Unit Pkg. 50

# Sec. 8

# TRUCK WHEEL HARDWARE

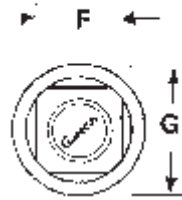
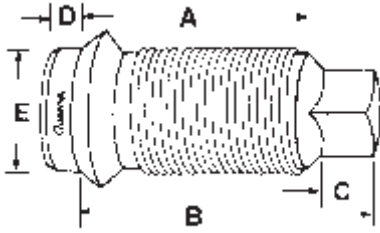

**1-1/8" Inner Cap Nuts**

**Zinc Plated**  
**3/4"-16 Inner Thread; 1-1/8"-16 Outer Thread**

Auveco Part No.	Thread Type	Description	Dimensions							Unit Pkg.
			A	B	C	D	E	F	G	
12520	LH	For Steel Wheels	1-7/16"	2-7/32"	17/32"	.....	1-3/16"	13/16"	1-13/32"	5
12522	RH	For Steel Wheels	1-7/16"	2-7/32"	17/32"	.....	1-3/16"	13/16"	1-13/32"	5
15003	RH	For Steel/Alum. Combo	1-15/16"	2-5/8"	19/32"	.....	1-7/32"	13/16"	1-13/32"	5
15004	LH	For Steel/Alum. Combo	1-15/16"	2-5/8"	19/32"	.....	1-7/32"	13/16"	1-13/32"	5
15009	RH	For Alum. Wheels; GR 8	1-21/32"	2-21/32"	5/8"	5/16"	1-1/8"	13/16"	1-13/32"	5
15010	LH	For Alum. Wheels; Gr 8	1-21/32"	2-21/32"	5/8"	5/16"	1-1/8"	13/16"	1-13/32"	5

### 1-1/8" Outer Cap Nut

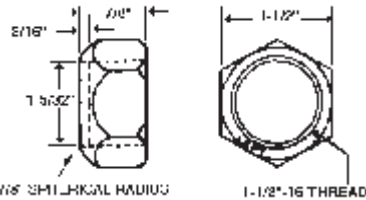

Zinc Plated

Auveco Part No.	Desc.	Unit Pkg.
12521	LH	5
12523	RH	5

### Standard Oil Seal Hubcap

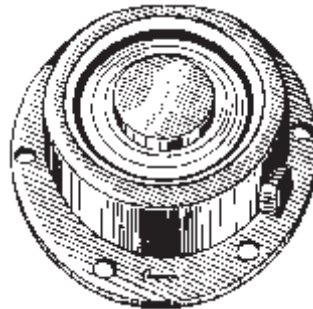

Auveco Part No.	Flange O.D.	Unit Pkg.
15026	6-1/4"	1

### Flange Wheel Nuts



Auveco Part No.	Thread	Hex Size	Flange O.D.	Unit Pkg.
15011	5/8-18(RH)	1-1/8"	1-5/8"	10

### 3/4" Outer Cap Nut

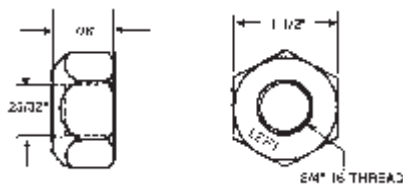

Single (3/4") Mounting Front & Rear  
 Zinc Plated

Auveco Part No.	Desc.	Unit Pkg.
12524	LH	5
12525	RH	5

**All items available in bulk. Call for a quotation.**

### Rim Clamp Nuts

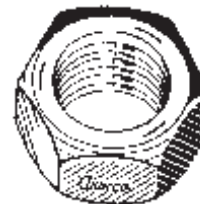

Zinc Plated

Auveco Part No.	Thread	Hex Size	Unit Pkg.
15014	5/8"-11	1-3/64"	25
15015	3/4"-10	1-1/4"	25

# TRUCK WHEEL HARDWARE

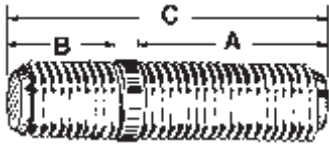

**Rim Studs**  
Grade 8 • Zinc Plated

Auveco Part No.	A Dia. & Length	B Dia. & Length	C Overall Length	Unit Pkg.
<b>15016</b> .....	5/8"-11 USS x 1-5/8" .....	5/8"-11 USS x 13/16" .....	2-3/4" .....	10
<b>15017</b> .....	3/4"-10 USS x 1-13/16" .....	3/4"-10 USS x 7/8" .....	3" .....	25
<b>15018</b> .....	3/4"-10 USS x 1-7/8" .....	3/4"-10 USS x 1" .....	3-1/8" .....	25

## Chrome Wheel Nut Covers



**15031**  
**Standard Lug Nut Cover**  
1-1/2" Diameter  
1-5/8" High

UNIT PACKAGE: 10

## Truck Wheel Hardware Interchange

The numbers listed in this interchange are cross referenced to the closest equivalent Auveco part. In some instances the parts are not identically the same; however, the Auveco part is designed to service the same application.

Part No.	Auveco Part No.	Part No.	Auveco Part No.	Part No.	Auveco Part No.	Part No.	Auveco Part No.	Part No.	Auveco Part No.
<b>ALCOA</b>		<b>BUDD</b>		<b>DAYTON WALTHER</b>		5706 .....	15018	W-11 .....	12522
5988-L .....	15010	10708 .....	12522	08-853501 ...	12523	5735-L .....	15004	W-12 .....	12520
5988-R .....	15009	35336 .....	15003	08-853502 ...	12521	5735-R .....	15003	W-13 .....	12523
<b>BATCO</b>		35337 .....	15004	08-853701 ...	12522	5988-L .....	15010	W-14 .....	12521
13-3005-R....	12522	37888 .....	12525	08-853702 ...	12520	5988-R .....	15009	W-15 .....	12525
13-3008-L ....	15004	37889 .....	12524	<b>EUCLID</b>		<b>GMC</b>		W-16 .....	12524
13-3008-R....	15003	37891 .....	12523	4956-A .....	15017	2201406 .....	12522	W-158 .....	15003
13-3012-L ....	12521	37892 .....	12521	4958 .....	15016	2201407 .....	12520	W-159 .....	15004
13-3013-L ....	12524	95188 .....	15011	4962 .....	15014	279670L .....	12521	W-246 .....	15018
13-3026-L ....	15010	<b>DAYTON</b>		4963 .....	15015	279670R .....	12523	W-486 .....	15009
13-3026-R....	15009	5149 .....	15014	5549-L .....	12520	<b>NUTURN</b>		W-487 .....	15010
13-6002 .....	15016	5715 .....	15017	5549-R .....	12522	W-5 .....	15016		
13-6003 .....	15017	5716 .....	15015	5552-L .....	12521	W-6 .....	15017		
13-6005 .....	15018	6654 .....	15016	5552-R .....	12523	W-7 .....	15014		
13-8003 .....	15014	8411 .....	15018	5652-L .....	12524	W-8 .....	15015		
13-8004 .....	15015			5652-R .....	12525				

# Sec. 9

# TEENUT® FASTENERS

**Round Base -3 Rivet or Nail Holes for Assembly**  
 Material: Low Carbon Steel, Plain Finish

For applications into materials of high density and where repeated bolt removal and replacement is expected.

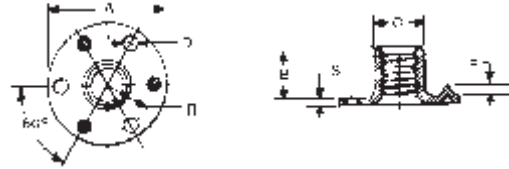

Auveco No.	Thread Size	A	B	C	D +.005	E	R	S	Unit Pkg.
18341	1/4-20	3/4	5/16	.311/.306	.098	5/64	19/64	.050	50
2262*	3/8-16	1	1/2	.471/.466	.145	5/64	5/64	.075	100

\*No Nib On Base, Zinc Finish

## Claw Prongs -Round Base

Material: Low Carbon Steel, Plain Finish

This Long Prong Teenut has six claw-like prongs that penetrate into wood, toe in, and grip so tightly that you have to drive it to back it out of its hole.



Auveco No.	Thread Size	A	B	C	D	S	Unit Pkg.
11322	8-32	3/4	1/4	.213/.208	3/16	.035	50
10729	10-24	3/4	9/32	.232/.227	13/64	.035	50
11324	1/4-20	3/4	5/16	.294/.289	15/64	.042	50
10730	1/4-20	3/4	7/16	.294/.289	15/64	.042	50
10731	5/16-18	7/8	3/8	.369/.364	19/64	.052	50
10732	3/8-16	1.0	7/16	.448/.443	11/32	.062	25

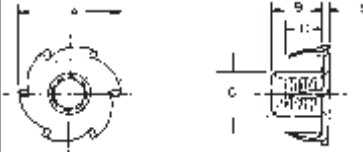

## Claw Prongs -Slimline, Round Base

Material: Low Carbon Steel, Plain Finish

Recommended where superior retention in soft wood is required.



Auveco No.	Thread Size	A	B	C	D	S	Unit Pkg.
11325	1/4-20	3/4	5/16	.294/.289	15/64	.042	100
11326	5/16-18	7/8	3/8	.369/.364	19/64	.052	50
11327	3/8-16	1.00	7/16	.448/.443	11/32	.062	25

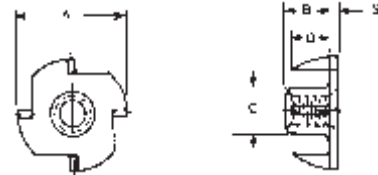

## Claw Prongs -Slimline, Round Base

Material: 300 Series Stainless Steel, Plain Finish



Auveco No.	Thread Size	A	B	C	D	S	Unit Pkg.
17013	1/4-20	3/4"	5/16"	19/64"	3/16"	.047"	25
17014	5/16"-18	7/8"	3/8"	25/64"	5/16"	.063"	10
17015	3/8-16	1"	7/16"	29/64"	11/32"	.071"	10

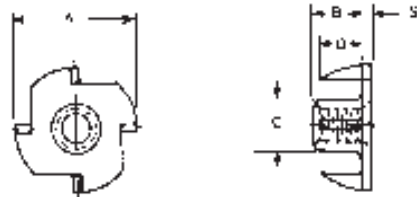

## Straight Prongs -Round Base

Material: Low Carbon Steel, Plain Finish

This Teenut is recommended for thick material applications and applications requiring the top of the barrel to provide a bearing surface for mating parts.



Auveco No.	Thread Size	A	B	C	D	Type	S	Unit Pkg.
11328	6-32	9/16	15/64	.164/.157	1/8	3 Prongs	.020	50
11331	10-32	3/4	9/32	.232/.227	13/64	3 Prongs	.035	50
11332	1/4-20	3/4	5/16	.311/.306	15/64	4 Prongs	.050	50

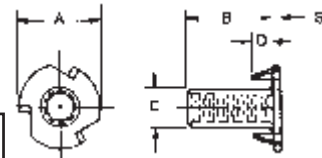



# AUVECO THIN SHEET NUTSERT® INSERTS

U.S.S., S.A.E. & Metric -Steel & Aluminum

**Sec. 9**

## Threaded Inserts For Thin Material

The Auveco Thin Sheet Nutsert has been designed to provide a highly efficient method of securing threads from one side of the work in materials generally too thin to support threads. Its performance has been proven in plastic, aluminum, mild steel and fiberglass withstanding high loads without vibrating or loosening under extreme operating conditions. The Auveco Thin Sheet Nutsert is a tension fastener with high pull out, insuring no rotation or vibration where a cover plate is used. The system's unique blind tooling installs TSNs at consistent rates using unskilled labor.

## How It Works

The Thin Sheet Nutsert, held securely by the tool, is placed into a prepared hole. Upon the tool's actuation, the threaded portion is pulled until the fastener's wall collapses radially outward, clinching it tight against the sheet. The tool is withdrawn, leaving the Thin Sheet Nutsert ready to receive a bolt or screw. This complete operation takes only a few seconds and can be performed by anyone.

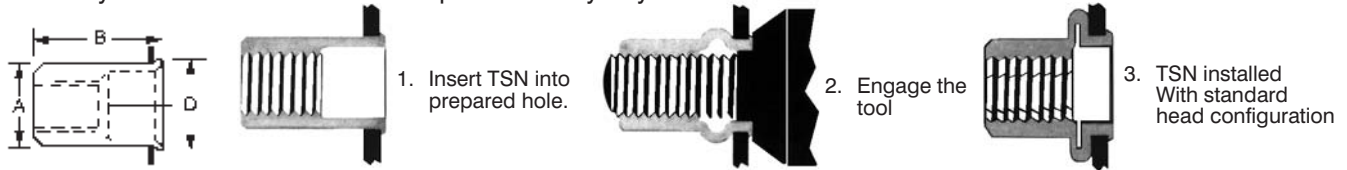

**Strength Tests:** Torque Strength -With an attaching part over the Thin Sheet Nutsert, offering a bearing surface, the TSN will remain intact past the point of the screw or bolt breaking (head torqued off). In almost all cases the threads of the TSN will remain undistorted and serviceable -an exception to this statement is when an extremely high tensile bolt is used.

**Steel:** 1010 Low Carbon Steel, Type 11 Class 3 with Zinc Plate, Clear Chromate

**Aluminum:** Aluminum Alloy 5056, Plain Finish, Metric Class 6H, U.S. Class 2B

To Set Nutserts, Use Tool 11805 & Conversion Kits Listed On Page 92.

## U.S.S. & S.A.E.

Auveco Part No.		Unit Pkg.	Thread Size After Installation	Recommended Grip Range	A Max.	B Max.	D Ref.	Hole Size	Drill Size
Steel	Aluminum								
11310	13476	50	6-32 U.S.S.	.020-.080"	.249"	.410"	.287"	.250-.254"	1/4"
11315	13477	100	6-32 U.S.S.	.020-.080"	.249"	.410"	.287"	.250-.254"	1/4"
11311	—	50	8-32 U.S.S.	.020-.080"	.249"	.410"	.287"	.250-.254"	1/4"
11316	13479	100	8-32 U.S.S.	.020-.080"	.249"	.410"	.287"	.250-.254"	1/4"
11312	13480	50	10-24 U.S.S.	.020-.130"	.280"	.465"	.320"	.281-.285"	9/32"
11317	13481	100	10-24 U.S.S.	.020-.130"	.280"	.465"	.320"	.281-.285"	9/32"
12978	—	50	10-32 S.A.E.	.020-.130"	.280"	.465"	.320"	.281-.285"	9/32"
12979	—	100	10-32 S.A.E.	.020-.130"	.280"	.465"	.320"	.281-.285"	9/32"
11313	—	25	1/4"-20 U.S.S.	.030-.165"	.347"	.610"	.415"	.375-.379"	3/8"
11318	—	100	1/4"-20 U.S.S.	.030-.165"	.347"	.610"	.415"	.375-.379"	3/8"
11314	—	25	5/16"-18 U.S.S.	.040-.200"	.499"	.720"	.540"	.500-.504"	1/2"
11319	—	100	5/16"-18 U.S.S.	.040-.200"	.499"	.720"	.540"	.500-.504"	1/2"
16785	—	15	3/8"-16 U.S.S.	.040-.200"	.499"	.720"	.540"	.500-.504"	1/2"

## Regular Pitch Metric

Auveco Part No.		Unit Pkg.	Thread Size After Installation	Recommended Grip Range "GR"	A Max.	B Max.	D Ref.	Hole Size	Drill Size
Steel	Aluminum								
12980	—	50	M4-.7	.020-.080" .508/2.030mm	.249" 6.32mm	.410" 10.41mm	.287" 7.29mm	.250-.254" 6.35/6.45mm	1/4"
12981	—	100	M4-.7	.020-.080" .508/2.030mm	.249" 6.32mm	.410" 10.41mm	.287" 7.29mm	.250-.254" 6.35/6.45mm	1/4"
12982	—	50	M5-.8	.020-.130" .508/3.300mm	.280" 7.11mm	.465" 11.81mm	.320" 8.13mm	.281-.285" 7.14/7.24mm	9/32"
12983	—	100	M5-.8	.020-.130" .508/3.300mm	.280" 7.11mm	.465" 11.81mm	.320" 8.13mm	.281-.285" 7.14/7.24mm	9/32"
12984	13494	25	M6-1.0	.030-.165" .762/4.190mm	.374" 9.50mm	.610" 15.49mm	.415" 10.54mm	.375-.379" 9.53/9.63mm	3/8"
12985	13495	100	M6-1.0	.030-.165" .762/4.190mm	.374" 9.50mm	.610" 15.49mm	.415" 10.54mm	.375-.379" 9.53/9.63mm	3/8"
12986	—	25	M8-1.25	.040-.200" 1.020/5.080mm	.499" 12.67mm	.720" 18.29mm	.540" 13.72mm	.500-.504" 12.71/12.80mm	1/2"
12987	—	100	M8-1.25	.040-.200" 1.020/5.080mm	.499" 12.67mm	.720" 18.29mm	.540" 13.72mm	.500-.504" 12.71/12.80mm	1/2"

# Sec. 9

# LARGE FLANGE THIN SHEET NUTSERT® INSERTS

## U.S.S., S.A.E. & Metric -Steel & Aluminum

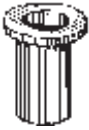

The Large Flange system provides captive threads in materials too thin to independently support threads, or where costly tapping operations are to be eliminated. The Large Flange fastener can be used as a rivet to join materials that will ultimately have a separate component attached.

Materials: Low Carbon Steel, Zinc Plated  
(Metric: Zinc & Yellow Plated)  
Aluminum Alloy, Plain Finish

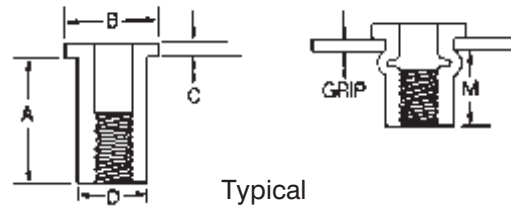

Typical

To Set 8-32, 10-24 and 10-32 Large Flange Nutserts, use tool 11805 and conversion kits listed on page 92. 1/4"-20, 5/16"-18 and 3/8"-16 Large Flange Nutserts require a pneumatic tool for installation. They can **not** be set with 11805.

### U.S.S. & S.A.E.

Auveco Part No.		Unit Pkg.	Thread Size	Grip Range	Hole Size	A +.015	B +.015	C (NOM)	D +.000 -.004	M (Ref.)
Aluminum	Steel									
16177	16187	50	8-32 U.S.S.	.010-.075"	.221-.226"	.438"	.357"	.032"	.221"	.300"
16178	16188	50	10-24 U.S.S.	.010-.080"	.250-.256"	.531"	.406"	.038"	.250"	.380"
16179	16189	50	10-24 U.S.S.	.080-.130"	.250-.256"	.594"	.406"	.038"	.250"	.390"
16180	16190	25	10-32 S.A.E.	.010-.080"	.250-.256"	.531"	.406"	.038"	.250"	.380"
.....	16191	25	10-32 S.A.E.	.080-.130"	.250-.256"	.594"	.406"	.038"	.250"	.390"
16182*	16192*	25	1/4"-20 U.S.S.	.020-.080"	.332-.338"	.625"	.475"	.058"	.332"	.450"
16183*	16193*	25	1/4"-20 U.S.S.	.080-.140"	.332-.338"	.687"	.475"	.058"	.332"	.450"
16184*	16194*	25	5/16"-18 U.S.S.	.030-.125"	.413-.423"	.750"	.665"	.062"	.413"	.505"
.....	16195*	25	5/16"-18 U.S.S.	.125-.200"	.413-.423"	.875"	.665"	.062"	.413"	.555"
16789*	16787*	10	3/8"-16 U.S.S.	.030-.115"	.490-.500"	.844"	.781"	.088"	.490"	.585"
16790*	16788*	10	3/8"-16 U.S.S.	.115-.200"	.490-.500"	.938"	.781"	.088"	.490"	.595"

\*Can **not** be set with Auveco tool 11805  
Requires pneumatic tool

### Regular Pitch Metric

Auveco Part No.		Unit Pkg.	Thread Size	Grip Range	Hole Size	A ±.015	B ±.015	C (NOM.)	D+.000 -.004	M (Ref.)
Aluminum	Steel									
.....	16978	25	M6-1.0	.020-.118" .5-3.0mm	.358" 9.1mm	.630" 16mm	.510" 13mm	.059" 1.5mm	.356" 9mm	.450" 11.5mm

# NUTSERT® INSERTS U.S.S. & S.A.E. THREAD

The Auveco Nutsert® was developed to offer both the production-oriented designer and engineer a unique and versatile anchor nut-type insert for high-speed installation. This Auveco system gives the designer the option to design for **blind** or **open** applications, eliminating and simplifying his design problems.

The Auveco Nutsert® system provides a cost-saving method of installing clean, load-bearing steel threads in castings, fiberglass, fiberboard, plastics, wood or almost any ductile material more than .030" thick.

A simple hand tool installs the Nutsert®...it is ready for use in seconds... no finishing is required after installation.

Auveco Nutsert's® advanced design offers unlimited grip range in a minimum of sizes...inventory is minimized to one body dimension per thread Size; ideally suited for blind...buried... and through holes. The ingenious "taper-lock" principle locks-in the Nutsert® preventing spin or twist; installs in flat or curved surfaces and is self-tightening with repeated use. The unique design of the installation tool eliminates marring of the parent material surface.

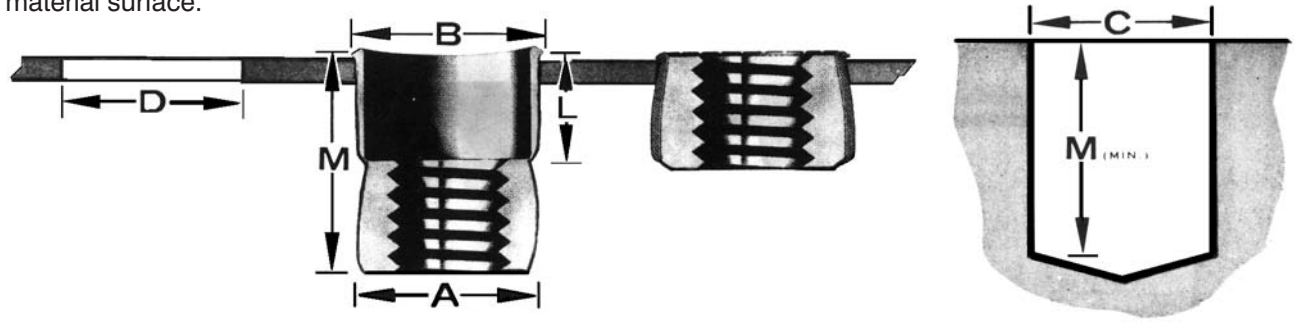

Material: Mild Steel, Cadmium Plated  
Minimum Grip: .030"

To Set Nutserts Use Tool 11805 & Conversion Kits Listed On Page 92.

Auveco Part No.	Unit Pkg.	Thread Size (Class 2B)	A	B	L	M	C	D	Recommended Nominal Hole Size	Weight Per Thousand (In Lbs.)
<b>10264</b> <b>10265</b> <b>10266</b>	25 100 1000	6-32 U.S.S.	.218"	.238"	.185"	.370"	Diameters vary with material density in blind application	Dependent upon material thickness and application	7/32"	1.50
<b>10267</b> <b>10268</b> <b>10269</b>	25 100 1000	8-32 U.S.S.	.249"	.264"	.185"	.370"			1/4"	2.00
<b>10270</b> <b>10271</b> <b>10272</b>	25 100 1000	10-24 U.S.S.	.280"	.300"	.185"	.370"			9/32"	2.25
<b>10273</b> <b>10274</b> <b>10275</b>	25 100 1000	10-32 S.A.E.	.280"	.300"	.185"	.370"			9/32"	2.25
<b>10276</b> <b>10277</b> <b>10278</b>	25 100 1000	1/4"-20 U.S.S.	.374"	.398"	.255"	.510"			3/8"	6.00
<b>10279</b> <b>10280</b>	25 100	1/4"-28 S.A.E.	.374"	.398"	.255"	.510"			3/8"	6.00
<b>10282</b> <b>10283</b> <b>10284</b>	10 100 500	5/16"-18 U.S.S.	.499"	.524"	.305"	.610"			1/2"	12.87
<b>10285</b> <b>10286</b>	10 100	5/16"-24 S.A.E.	.499"	.524"	.305"	.610"			1/2"	12.87
<b>10288</b> <b>10289</b> <b>10290</b>	10 50 100	3/8"-16 U.S.S.	.561"	.590"	.370"	.740"			9/16"	18.00

**Sec. 9**

**NUTSERT® HAND TOOL & US & METRIC CONVERSION KITS**



**11805**  
 Nutsert Hand Tool  
 For regular and thin sheet Nutserts  
 (Does not include any conversion kits)  
 Hand Tool only with wrench

UNIT PACKAGE: 1

Conversion Kits For  
 No. 11805 Gun

Size	Use Tool 11805 with Auveco Conversion Kit Listed
6-32 U.S.S.	<b>11807</b>
8-32 U.S.S.	<b>11808</b>
10-32 S.A.E.	<b>11809</b>
10-24 U.S.S.	<b>11810</b>
1/4-20 U.S.S.	<b>11811</b>
1/4-28 S.A.E.	<b>11812</b>
5/16-18 U.S.S.	<b>11813</b>
5/16-24 S.A.E.	<b>11814</b>
3/8-16 U.S.S.	<b>11815</b>
M4-.7	<b>12988</b>
M5-.8	<b>12989</b>
M6-1.0	<b>12990</b>
M8-1.25	<b>12991</b>
Unit Package: 1	



**11806**

Nutsert Tool Kit  
 (Complete in metal case)  
 Includes hand tool 11805, nose piece wrench, and conversion kits (nose piece & mandrel) for the following sizes: 6-32, 8-32, 10-24, 10-32, 1/4-20 & 5/16-18.

UNIT PACKAGE: 1

**16341**

Metric Nutsert Tool Kit  
 (Complete in metal case)  
 Includes hand tool 11805, nose piece wrench, and conversion kits (nose piece & mandrel) for the following sizes: M4-.7, M5-.8, M6-1.0 (2 kits) & M8-1.25.

UNIT PACKAGE: 1

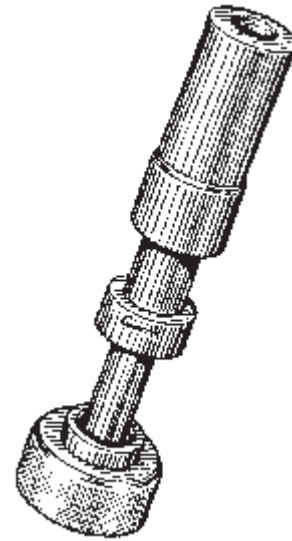

**15544**

Mandrel Puller  
 Replacement Mandrel Puller  
 For Auveco 11805 Nutsert Tool  
 1/4-28 Left-Hand Thread

UNIT PACKAGE: 1

# THREAD REPAIR INSERTS

Here's the easy way to repair stripped threads.



Easy Installation/4 Simple Steps  
Instructions Must Be Followed Exactly

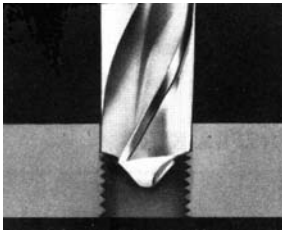

**1** Drill out old threads, using standard drill.

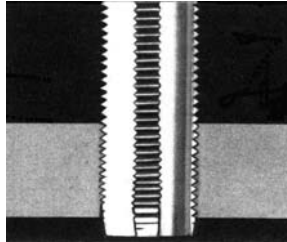

**2** Tap new threads, using standard tap

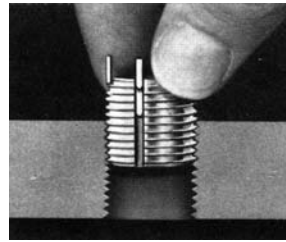

**3** Screw in insert until slightly below surface. "kees" act as depth stop.

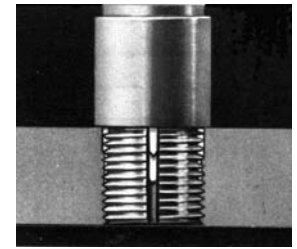

**4** Drive "Kees" down with several light taps on installation tool.

**Features:**

- Installed with standard drills and taps.
- No pre-winder tool required.
- Impossible to cross thread while installing.
- No tang break-off.
- May be used in virtually any material...aluminum, magnesium, cast iron, cold rolled steel and plastic

- Provide high strength and reliability. One length per size provides maximum pullout strength.
- Positive mechanical lock against rotation.
- Breaks Grade 8 bolts in test after test.
- Easy to remove.



**5** Installed Insert.

**Thinwall Inserts**

Auveco Part No.	Internal Thread Size (Bolt Size)	External Thread Size	No. of Kees	Insert Length	Drill Size	Tap Size	Professional Installation Tool Part No.	Inserts Per Unit Package
12374	10-24	5/16"-18	2	.31"	"I"	5/16"-18	.....	4*
17515								25
17516								50
12375								4*
17517	10-32							25
17518								50
12376								4*
17519	1/4"-20	3/8"-16	2	.37"	"Q"	3/8"-16	12394	25
17520								50
12377								4*
17521								25
12378	5/16"-18	7/16"-14	4	.43"	"X"	7/16"-14	12395	4*
17522								25
17523								50
12379								4*
17524	3/8"-16	1/2"-13	4	.50"	29/64"	1/2"-13	12396	25
12380								3*
17525								25
17526								50
12381	7/16"-14	9/16"-12	4	.56"	33/64"	9/16"-12	12397	3*
17527								25
12382								3*
17528								25
12383	7/16"-20							3*
17529								25
12384								2*
17530								15
17531	1/2"-13	5/8"-11	4	.62"	37/64"	5/8"-11	12398	25
12385								2*
17532								15

\*Contains Economy Drive Tool No. 12404

For an Assortment of Thin Wall Inserts, see Fix-Kit No. 6176

**THREAD REPAIR INSERTS**



**Heavy Duty Thread Repair Inserts**

Auveco Part No.	Internal Thread Size (Bolt Size)	External Thread Size	No. of Kees	Insert Length	Drill Size	Tap Size	Professional Installation Tool Auveco Part No.†	Inserts Per Unit Package
17238	10-24	3/8"-16	2	.31"	"Q"	3/8"-16	◆	4
17239	10-32							4
17240	1/4"-20	7/16"-14	2	.37"	"X"	7/16"-14	◆	4
17241	1/4"-28							4
17242	5/16"-18	1/2"-13	4	.43"	29/64"	1/2"-13	◆	4
17243	5/16"-24							4
17244	3/8"-16	9/16"-12	4	.50"	33/64"	9/16"-12	◆	3
17245	3/8"-24							3
17246	7/16"-14	5/8"-11	4	.62"	37/64"	5/8"-11	◆	3
17247	7/16"-20							3
17248	1/2"-13	3/4"-16	4	.62"	45/64"	3/4"-16	◆	2
17249	1/2"-20							2
16159	5/8"-11	7/8"-14	4	.87"	53/64"	7/8"-14	16163	2
17533								15
16160	5/8"-18							2
17534								15
16161	3/4"-10	1-1/8"-12	4	1.12"	1-1/16"	1-1/8"-12	16164	2
17535								10
16162	3/4"-16							2
17536								10

† Not Packaged with the Thread Repair Inserts

◆ Professional tool not available. Can be set with 12404 Economy Drive Tool one kee at a time.

**Metric Thread Repair Inserts®**

Auveco Part No.	Internal Thread Size (Bolt Size)	External Thread Size	No. of Kees	Insert Length	Drill Size	Tap Size	Professional Installation Tool Auveco Part No.†	Inserts Per Unit Package
12386	M5-0.8	M8-1.25	2	.315"	"H"	M8-1.25	12399	3*
17537								15
12387	M6-1.0	M10-1.25	2	.394"	"S"	M10-1.25	12400	3*
17538								15
12389	M8-1.0	M12-1.25	4	.472"	27/64"	M12-1.25	◆	2*
17539								10
12390	M8-1.25							2*
17540								10
12391	M10-1.25	M14-1.5	4	.551"	1/2"	M14-1.5	◆	2*
17541								10
12392	M10-1.5							2*
17542								10

\*Contains Economy Drive Tool 12404

† Not Packaged with the Thread Repair Inserts

◆ Professional tool not available. Can be set with 12404 Economy Drive Tool one kee at a time.

# THREAD REPAIR INSERTS

## Professional Insert Installation Tool



Auveco Tool No.	Installs Insert Sizes (Internal Thread)
<b>12394</b>	1/4"-20 & 1/4"-28
<b>12395</b>	5/16"-18 & 5/16"-24
<b>12396</b>	3/8"-16 & 3/8"-24
<b>12397</b>	7/16"-14 & 7/16"-20
<b>12398</b>	1/2"-13 & 1/2"-20

Auveco Tool No.	Installs Insert Sizes (Internal Thread)
<b>12399</b>	M5-0.8
<b>12400</b>	M6-1.0
<b>16163</b>	5/8"-11 H.D. & 5/8"-18 H.D.
<b>16164</b>	3/4"-10 H.D. & 3/4"-16 H.D.

### Economy Driver Tool



### No. 12404

Will install approximately 10 Inserts. Use with Thinwall Inserts up to 1/2" and 10mm Internal Diameter and Heavy Duty Inserts up to 1/2" Internal Diameter

UNIT PACKAGE: 5

### Thread Repair Insert Assortments

No. 12405 "Assortment Kit" Contains			No. 12406 "Assortment Kit" Contains			No. 12407 "Assortment Kit" Contains		
Auveco Part No.	Qty	Size	Auveco Part No.	Qty	Size	Auveco Part No.	Qty	Size
<b>12374</b>	3	10-24	<b>12375</b>	3	10-32	<b>12387</b>	2	M6-1.0
<b>12376</b>	3	1/4"-20	<b>12377</b>	3	1/4"-28	<b>12389</b>	2	M8-1.0
<b>12378</b>	3	5/16"-18	<b>12379</b>	3	5/16"-24	<b>12390</b>	2	M8-1.25
<b>12380</b>	3	3/8"-16	<b>12381</b>	3	3/8"-24	<b>12391</b>	2	M10-1.25
<b>12404</b>	2	Installation Tools	<b>12404</b>	2	Installation Tools	<b>12404</b>	1	Installation Tool

# Sec. 9

## HELI-COIL® THREAD REPAIR INSERTS & KITS

For Repairing Stripped Or Damaged Threads

Heli-Coil® has the most effective and universally accepted method of thread repair.

Heli-Coil® Inserts quickly and permanently restore stripped, worn or damaged threads to their original size and condition.



**Easy to use... just 1. Drill 2. Tap 3. Install**  
**Now you're back to the original size and**  
**the original size fastener can be used.**

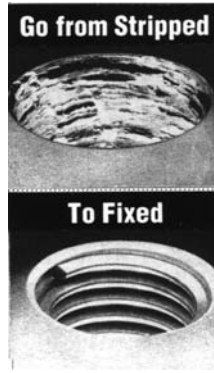

When threads become stripped, worn or damaged for any reason, the strength and reliability are greatly reduced. When this happens on critical threaded assemblies, cars, and other types of equipment, it may become unsafe to operate. These potentially dangerous situations are eliminated when the damaged thread is repaired with a Heli-Coil® screw thread insert. The Heli-Coil® threaded insert provides stronger, more reliable threads than the original tapped hole and at the same time eliminates the possibility of thread wear, seizing and corrosion.

Thread Size & Length	Heli-Coil® Kits		Heli-Coil® Insert		Metal Installation Tool		Tap		Required Drill Size
	Contents: Number of inserts shown, one installation tool & one tap.		Auveco Part No.	Unit Pkg.	Auveco Part No.	Unit Pkg.	Auveco Part No.	Unit Pkg.	
	Auveco Kit No.	Inserts Per Kit							
<b>U.S.S. COARSE THREAD (18-8 Stainless Steel)</b>									
10-24 x .285"	18621	10	18544	10	18571	1	18596	1	13/64"
1/4"-20 x .375"	18622	10	18545	10	18572	1	18597	1	17/64"
5/16"-18 x .469"	18623	10	18546	10	18573	1	18598	1	21/64"
3/8"-16 x .562"	18624	10	18547	10	18574	1	18599	1	25/64"
7/16"-14 x .656"	....	....	18548	10	18575	1	18600	1	29/64"
1/2"-13 x .750"	18626	5	18549	10	18576	1	18601	1	17/32"
5/8"-11 x .938"	18627	5	18550	10	18577	1	18602	1	21/32"
3/4"-10 x 1.125"	....	....	18551	5	18578	1	....	....	25/32"
<b>S.A.E. FINE THREAD (18-8 Stainless Steel)</b>									
10-32 x .285"	18629	10	18552	10	18579	1	18604	1	13/64"
1/4"-28 x .375"	18630	10	18553	10	18580	1	18605	1	17/64"
5/16"-24 x .469"	....	....	18554	10	18581	1	....		21/64"
3/8"-24 x .562"	....	....	18555	10	18582	1	18607	1	25/64"
7/16"-20 x .656"	....	....	18556	10	18583	1	18608	1	29/64"
1/2"-20 x .750"	18634	5	18557	10	18584	1	18609	1	33/64"
<b>METRIC REGULAR PITCH (18-8 Stainless Steel)</b>									
M6-1.00 x 9.0mm	18635	10	18558	10	18585	1	18610	1	1/4"
M8-1.25 x 12.0mm	18636	10	18559	10	18586	1	18611	1	21/64"
M9-1.25 x 13.5mm	....	....	18560	10	18587	1	18612	1	"U"
M10-1.50 x 15.0mm	....	....	18561	10	18588	1	18613	1	13/32"
M11-1.50 x 16.5mm	....	....	....	....	18589	1	18614	1	29/64"
M12-1.75 x 18.9mm	18644	5	18565	5	18592	1	18617	1	31/64"
<b>METRIC FINE PITCH (18-8 Stainless Steel)</b>									
M10-1.25 x 15.0mm	....	....	18563	10	18590	1	18615	1	13/32"
M11-1.25 x 16.5mm	....	....	18564	10	18591	1	....	....	29/64"
M12-1.50 x 18.0mm	....	....	18566	5	18593	1	18618	1	31/64"
M12-1.25 x 18.0mm	18642	5	18567	5	18594	1	18619	1	31/64"
<b>SPARK PLUG THREAD (Mild Carbon Steel)</b>									
M14-1.25 x 3/8"	....	....	18568	2	18595	1	18620	....	Do Not Drill. Use Piloted Tap 18620
M14-1.25 x 1/2"			18569	2					
M14-1.25 x 3/4"			18570	2					



**JACK NUTS®**

Material - 1010 Steel - Zinc Plated

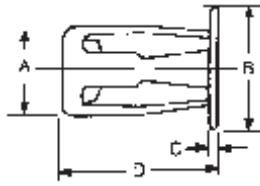

Type 1



Type 2



Type 3

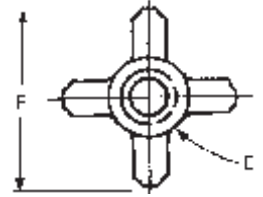

Auveco Part No.	Unit Pkg.	Type	Thread (E)	Body Dia. (A)	Head Dia. (B)	Cap Thick (C)	Overall Lgth (D)	Grip Range	Required Hole Dia.	Maximum Spread (F)**
<b>13012</b>	25	1	6-32	.318	.468	.073	.653	1/64"-3/16"	.315-.330	.660
<b>13014</b>	25	1	10-24	.382	.531	.073	.716	1/64"-3/16"	.385-.400	.760
<b>13016</b>	25	1	1/4"-20	.438	.625	.073	.731	1/64"-3/16"	.434-.450	.890
<b>16235*</b>	15	2	1/4"-20	.438	.625	.073	.731	1/64"-3/16"	.434-.450	.890
<b>13017</b>	25	1	1/4"-20	.438	.625	.073	.919	3/16"-3/8"	.434-.450	.890
<b>16227</b>	25	1	M4-.7	.318	.468	.073	.841	3/16"-3/8"	.318-.330	.720
<b>16228</b>	25	1	M5-.8	.382	.531	.073	.716	1/64"-3/16"	.382-.400	.760
<b>16234•</b>	25	3	M6-1.0	.438	.625	.073	.731	1/64"-3/16"	.438-.450	.890

\* Raintite Sealer

\*\* Spread Varies With Material Thickness

• Sealer

**Special Purpose Jack Nuts®**

Auveco Part No.	O.E.M. Number	Type	Thread	Finish	O.E.M. Application	Unit Pkg.
<b>12995</b>	GM: 367292 Chry: 6031438	3	1/4-20	Zinc w/Sealer	GM Mirror Mounting Nut	25
<b>12996</b>	GM: 367292 Chry: 6031438	3	1/4-20	Zinc w/ Sealer	GM Mirror Mounting Nut	100
<b>12998</b>	GM: 1623436	2	M5-.8	Zinc w/Raintite	GM "J" Body Rack Mount	10
<b>16230</b>	GM: 5970995	1	M6-1.0	Zinc	License Plate Mounting Bracket	25
<b>12997</b>	GM: 1635218, 10014363	1	M6-1.0	Zinc w/Laquer	GM License Plate Nut	25
<b>12999</b>	GM: 14007940	2	M6-1.0	Zinc w/Raintite	GM "X" & "Y" Roof Rack Mounting Nut	10

**Sec. 9**

**JACK NUT® INSTALLATION TOOLS**

Tool comes with  
16856 (6-32 Thread)  
Installation Rod

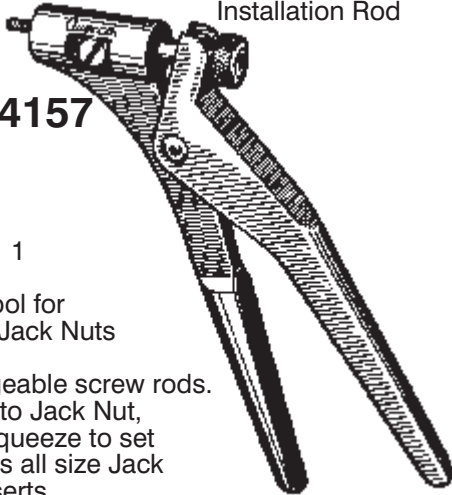

**Part No. 14157**  
Professional  
Jacknut®  
Installation Tool

UNIT PACKAGE: 1

An economical tool for rapidly installing Jack Nuts in any material. Takes interchangeable screw rods. Just screw rod into Jack Nut, push into hole, squeeze to set and remove. Sets all size Jack Nut Threaded Inserts.

**Jacknut® Installation Rods**

Use w/14157 Installation Tool



Auveco Part No.	Unit Pkg.	Thread
16856	1	6-32
14158	1	10-24
14159	1	1/4-20
14160	1	4mm
14161	1	5mm
14162	1	6mm

**Part No. 14156**  
Friction Wrench

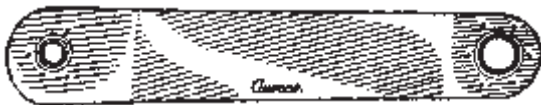

For use when installing a limited quantity of Jack Nuts. Insert the wrench between the screw and the head of the fastener, hold wrench and run in screw to set Jack Nut.

UNIT PACKAGE: 10



**Mirror Mounting Screws And Jack Nuts**

For additional information refer to listings on pages 25, 26 and 52.

Auveco Part No.	Description	Unit Pkg.
13231	1/4-20 x 7/8" Screw (Phos.)	25
13232	1/4-20 x 7/8" Screw (Phos.) & Jack Nut®	25
14947	M6 x 26mm Screw (Chrome)	25
14976	1/4-20 x 1-1/4" Screw (Stainless Steel)	25
14977	1/4-20 x 1-1/4" Screw (Stainless Steel) & Jack Nut®	10
17179	1/4-20 x 1-1/4" Screw (Phos. Organic)	25

**Square Head Plastic Expansion Nut**

Use with #8 or #10 Tapping Screws



Auveco Part No.	Head Height	Body Length	Body Width	Square Panel Hole	Unit Pkg.
11308	.500	.305	.25	.250-.281	50

**Square Head Nylon Push-In Nut**



Diameter 3/8"  
Thickness .025/.035

Auveco Part No.	Thread Size	Hole Size Square	Panel Range	Unit Pkg.
10305	#8	.265/.292	.030/.160	50

Visit the **Auveco® PRODUCTS** Web Site at [www.auveco.com](http://www.auveco.com)

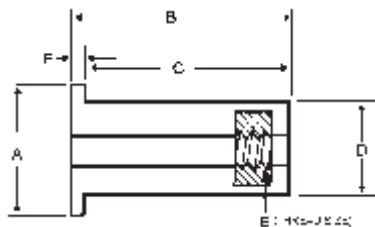

**WELL NUTS®**

Material - Neoprene with Captive Brass Nut



Auveco Part No.	Unit Pkg.	(E) Thread	(A) Head Dia.	(B) Overall Length	(C) Shank Length	(D) Shank Dia.	(F) Head Thick	Hole Size	Grip Range (For Wall Thickness)	O.E.M. Number	O.E.M. Application
<b>13006</b>	25	#6-32	.452	.499	.437	.312	.062	5/16	.015-.156	....	....
<b>16236</b>	25	#6-32	.554	.981	.946	.240	.035	1/4	.375-.607	....	....
<b>16237</b>	25	#8-32	.438	.499	.447	.312	.052	5/16	.015-.156	Chry: 6026166 GM: 347065	Rear Compt. Cover Support
<b>13005</b>	25	#8-32	.750	.575	.500	.312	.062	5/16	.015-.172	GM: 14048060	License Plate
<b>16240</b>	25	#10-24	.562	.767	.580	.375	.187	3/8	.030-.227	GM: 3876130	Voltage Reg & Dome Light
<b>16246†</b>	25	#10-32	.510	.400	.341	.375	.059	3/8	.015-.050	GM: 6264396 AMC: 4005237	Hatchback Window Brkt
<b>13007</b>	25	#10-32	.500	.554	.518	.377	.036	3/8	.015-.192	....	....
<b>13009</b>	10	#10-32	.562	.665	.625	.377	.040	3/8	.035-.232	GM: 12338025	Luggage Rack
<b>17586</b>	15	#10-32	.750	.703	.625	.375	.078	3/8	.030-.227	....	....
<b>16244</b>	25	#10-32	.750	.807	.620	.375	.187	3/8	.030-.227	....	....
<b>13008</b>	10	#10-32	.562	1.051	1.000	.375	.051	3/8	.312-.643	....	....
<b>13004</b>	25	1/4-20	.625	.641	.594	.500	.051	1/2"	.015-.111	GM: 528846 AMC: 4003120	Luggage Rack
<b>16255</b>	15	1/4-20	.635	.801	.750	.500	.051	1/2"	.187-.343	....	....
<b>13010</b>	10	1/4-20	.740	.829	.642	.500	.187	1/2"	.031-.187	....	....
<b>16253</b>	25	1/4-20	.635	1.051	1.000	.500	.051	1/2"	.250-.457	GM: 342271	Luggage Rack
<b>13011</b>	10	5/16-18	.875	.725	.600	.620	.125	5/8	.015-.187	....	....
<b>16239</b>	25	M5-8	.562	.562	.437	.375	.125	3/8	.015-.050	GM: 22520368	Luggage Rack
<b>16247†</b>	25	M5-8	.510	.400	.341	.375	.059	3/8	.015-.050	GM: 1622920	Luggage Rack
<b>16242</b>	25	M5-8	.500	.554	.518	.375	.036	3/8	.015-.192	....	....
<b>16248</b>	25	M5-8	.562	.665	.625	.375	.040	3/8	.035-.232	GM: 14005097	Service Part
<b>13000</b>	10	M6-1.0 w/ss screw #10 Head	.787	.630	.579	.500	.051	1/2"	.015-.094	GM: 20130258, 14002811	Station Wagon Roof Rack
<b>13001</b>	50										
<b>13002</b>	10										
<b>13003</b>	50	M6-1.0	.787	.630	.579	.500	.051	1/2"	.015-.094	GM: 20130258, 14002811	Station Wagon Roof Rack
<b>16251</b>	25	M6-1.0	.630	.630	.579	.500	.051	1/2"	.015-.111	GM: 15505451 AMC: 8934201293	Luggage Rack License Plate
<b>16252</b>	25	M6-1.0	.750	.829	.642	.500	.187	1/2"	.031-.187	VW: 175 820 435	Luggage Rack
<b>16254</b>	25	M6-1.0	.635	1.051	1.000	.500	.051	1/2"	.250-.457	....	....
<b>16256</b>	10	M8-1.25	.875	.725	.600	.620	.125	5/8	.015-.156	AMC: 8934201493	Radiator Brkt.

† Comes with snap-in feature

# Sec. 9

## RUBBER NUT INSERTS

Neoprene Rubber With A Brass Nut

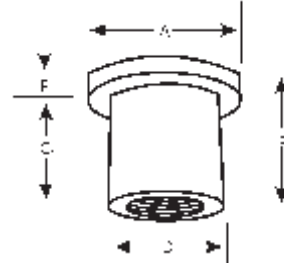

Part Number	Unit Pkg.	Thread	(A) Head Dia.	(B) Overall Length	(C) Shank Length	(D) Shank Dia.	(E) Head Height	Hole Size	Grip Range
<b>19911</b>	25	#6-32	.433	.496	.441	.311	.055	5/16	.015-.156
<b>19915</b>	25	1/4-20	.630	.630	.579	.500	.051	1/2	.015-.110
<b>19917</b>	15	5/16-18	.870	.721	.595	.626	.126	5/8	.015-.156
<b>19918</b>	15	M5-.8	.551	1.570	1.519	.375	.051	3/8	.808-1.182
<b>19919</b>	25	M5-.8	.551	.847	.811	.375	.036	3/8	.311-.449
<b>19920</b>	25	M5-.8	.551	.670	.631	.375	.039	3/8	.034-.233
<b>19921</b>	25	M5-.8	.500	.556	.520	.375	.036	3/8	.015-.193
<b>19922</b>	25	M6-1.0	.630	.630	.579	.500	.051	1/2	.015-.110
<b>19923</b>	25	M6-1.0	.642	1.052	.973	.500	.079	1/2	.252-.453

## TUBULAR TYPE NUTS (LISTED BY STUD SIZE) ILLUSTRATIONS ACTUAL SIZE



**3136**

Phosphate

1/16" Stud Size  
Panel Range: .025"-.125"  
Fits Into .086" Hole

UNIT PACKAGE: 100



**3776**

Phosphate

3/32" Stud Size  
Panel Range: .032"-.040"  
Fits Into 1/8" Hole

UNIT PACKAGE: 100



**13963**

Nylon

7/64" Stud Size  
Barrel Length: 29/64"  
Head Dia.: 1/4"  
Head Thick: 1/32"  
Fits Into 3/16" Hole

UNIT PACKAGE: 100



**13961**

Nylon

1/16" Stud Size  
Panel Range: 7/32"  
Fits Into 9/64" Hole

UNIT PACKAGE: 50



**3137**

Phosphate

3/32" Stud Size  
Panel Range: .025"-.175"  
Fits Into 1/8" Hole

UNIT PACKAGE: 100



**11293**

(375890-S102)

Green

With Sealer

1/8" Stud Size  
Panel Range: .035"-.045"  
Fits Into 3/16" Hole

UNIT PACKAGE: 50



**13962**

Nylon

5/64" Stud Size  
Barrel Length: 7/32"  
Head Dia.: 7/32"  
Head Thick: 3/64"  
Fits Into 5/32" Hole

UNIT PACKAGE: 50



**2596**

Phosphate

3/32" Stud Size  
Panel Range: .031"-.041"  
Fits Into 1/8 x 5/32" Hole

UNIT PACKAGE: 100

















**13964**

Nylon

1/8" Stud Size  
Barrel Length: 11/32"  
Head Dia.: 15/64"  
Head Thick: 1/32"  
Fits Into 11/64" Hole

UNIT PACKAGE: 50

**TUBULAR TYPE NUTS**  
**(LISTED BY STUD SIZE)**  
**ILLUSTRATIONS ACTUAL SIZE**

 <p><b>2595</b> Phosphate 1/8" Stud Size Panel Range: .040"-.045" Fits Into 3/16" Hole UNIT PACKAGE: 100</p>	 <p><b>8545</b> Phosphate 5/32" Stud Size Panel Range: .062"-.068" Fits Into 7/32" Hole UNIT PACKAGE: 100</p>	 <p><b>2565</b> Phosphate 3/16" Stud Size Panel Range: .020"-.032" Fits Into 7/32" Hole UNIT PACKAGE: 100</p>
 <p><b>3777</b> Phosphate 1/8" Stud Size Panel Range: .038"-.044" Fits Into 5/32" Hole UNIT PACKAGE: 100</p>	 <p><b>8546</b> Phosphate 5/32" Stud Size Panel Range: .049"-.055" Fits Into 7/32" Hole UNIT PACKAGE: 100</p>	 <p><b>13966</b> (8934-201-767) Black Nylon 3/16" Stud Size Barrel Length 17/64" Head Dia. 5/16" Head Thick. 1/32" Fits Into 17/64" Hole UNIT PACKAGE: 100</p>
 <p><b>2611</b> Phosphate 1/8" Stud Size Panel Range: .030"-.036" Fits Into 5/32" Hole UNIT PACKAGE: 100</p>	 <p><b>10073</b> (6000558) Phosphate 3/16" Stud Size Panel Range: .038"-.044" Fits Into 7/32" Hole UNIT PACKAGE: 100</p>	 <p><b>8578</b> Nylon #10 Thread Screw Fits Into 5/16" Hole UNIT PACKAGE: 50</p>
 <p><b>5854</b> (373528-S32) (6000605) Phosphate 1/8" Stud Size Panel Range: .025"-.045" Fits Into 3/16" Hole UNIT PACKAGE: 100</p>	 <p><b>10072</b> (1494015) Phosphate 3/16" Stud Size Panel Range: .154"-.160" Fits Into 7/32" Hole UNIT PACKAGE: 100</p>	 <p><b>5196</b> (354341-S) Phosphate 1/4" Stud Size Panel Range: .034"-.040" Fits Into 9/32" Hole UNIT PACKAGE: 100</p>
 <p><b>5195</b> (375480-S100) (3783794) Phosphate 1/8" Stud Size Panel Range: .036"-.046" Fits Into 1/4" Hole UNIT PACKAGE: 100</p>	<p style="text-align: center;"><b>Inquire About Our          FasTrack Cost          Recovery Program          For Body Shops</b></p>	
 <p><b>13965</b> (4006316) Nylon 5/32" Stud Size Barrel Length 1/4" Head Dia. 1/4" Head Thick. 1/32" Fits Into 3/16" Hole UNIT PACKAGE: 100</p>		

For An Assortment Of Tubular Nuts See Fix-Kits 6007, 6148 & 6502 in the green pages.

# Sec. 9

## Flat Nuts (ILLUSTRATIONS ACTUAL SIZE)

### For Screws



**1896**  
Phosphate

#2-56 Machine Screw Size  
7/32" x 3/8"

UNIT PACKAGE: 100



**2089**  
Phosphate

#6-32 Machine Screw Size  
5/16" x 1/2"

UNIT PACKAGE: 100



**1898**  
Phosphate

#6-32 Machine Screw Size  
1/2" x 7/8"

UNIT PACKAGE: 100



**18209**  
Phosphate

#8 Tapping Screw Size  
5/16" x 1/2"

UNIT PACKAGE: 100



**5563**  
Phosphate

No. 8 Tapping Screw Size  
13/32" x 5/8"

UNIT PACKAGE: 100



**3793**  
Phosphate

No. 8 Tapping Screw Size  
13/32" x 5/8"

UNIT PACKAGE: 100



**1899**  
Phosphate

#8-32 Machine Screw Size  
1/2" x 7/8"

UNIT PACKAGE: 100



**2091**  
Phosphate

#8-32 Machine Screw Size  
5/16" x 1/2"

UNIT PACKAGE: 100



**1900**  
Phosphate

#10 Tapping Screw  
Size 1/2" x 7/8"

UNIT PACKAGE: 100



**2092**  
Phosphate

#10-24 Machine  
Screw Size  
7/16" x 3/4"

UNIT PACKAGE: 100



**1912**  
Phosphate

#12 Tapping Screw Size  
1/2" x 3/4"

UNIT PACKAGE: 100



**1903**  
Phosphate

1/4"-20 Machine Screw Size  
9/16" x 1"

UNIT PACKAGE: 100



**14390**  
Phosphate

7/16"-20 Screw Size  
11/16" x 15/16"

UNIT PACKAGE: 50

### For Studs



**2098**  
Phosphate

1/16" Stud Size  
7/32" x 3/8"

UNIT PACKAGE: 100



**2100**  
Phosphate

3/32" Stud Size  
1/4" x 7/16"

UNIT PACKAGE: 100



**1906**  
Phosphate

.100" or 3/32" Stud Size  
7/32" x 7/16"

UNIT PACKAGE: 100



**1914**  
Phosphate

.100" or 3/32" Stud Size  
5/16" x 1/2"

UNIT PACKAGE: 100



**3559**  
Phosphate

1/8" Stud Size  
11/32" x 3/8"

UNIT PACKAGE: 100



**2099**  
Phosphate

1/8" Stud Size  
5/16" x 9/16"

UNIT PACKAGE: 100



**2102**  
Phosphate

5/32" Stud Size  
3/8" x 9/16"

UNIT PACKAGE: 100



**1905**  
Phosphate

5/32" Stud Size  
7/16" x 3/4"

UNIT PACKAGE: 100



**8586**  
Phosphate

3/16" Stud Size  
3/8" x 1/2"

UNIT PACKAGE: 100



**2426**  
Phosphate

3/16" Stud Size  
3/8" x 5/8"

UNIT PACKAGE: 100



**2103**  
Phosphate

3/16" Stud Size  
3/8" x 5/8"

UNIT PACKAGE: 100



**2105**  
Phosphate

1/4" Stud Size  
7/16" x 5/8"

UNIT PACKAGE: 100



**3138**  
Phosphate

5/16" Stud Size  
1/2" x 11/16"

UNIT PACKAGE: 100

















**3139**  
Phosphate

3/8" Stud Size  
9/16" x 3/4"

UNIT PACKAGE: 100

**“U” & “J” Type Nuts By Screw Size**

(ILLUSTRATIONS ACTUAL SIZE)

 <p><b>9625</b> Phosphate</p> <p>#6 Screw Size Panel Range: .090"-.110" Ctr Of Hole To Edge: 9/32"</p> <p>UNIT PACKAGE: 100</p>	 <p><b>10666</b> Phosphate</p> <p>#8 Screw Size Panel Range: .025"-.035" Ctr Of Hole To Edge: 11/32"</p> <p>UNIT PACKAGE: 100</p>	 <p><b>8337</b> Phosphate</p> <p>#8-18 Screw Size Panel Range: .025"-.040" Center Of Hole To Edge: 3/8"</p> <p>UNIT PACKAGE: 50</p>
 <p><b>5571</b> Phosphate</p> <p>#8 Screw Size Panel Range: .025"-.040" Ctr Of Hole To Edge: 1/4"</p> <p>UNIT PACKAGE: 100</p>	 <p><b>11292</b> (445429, 9422552) Zinc</p> <p>#8 Screw Size Panel Range: .045"-.062" Center Of Hole To Edge: 3/8"</p> <p>UNIT PACKAGE: 50</p>	 <p><b>14822</b> (25527289) Phosphate</p> <p>M4.2-1.41 (#8) Screw Size Panel Range: .094"-.109" Center Of Hole To Edge: 7/32"</p> <p>UNIT PACKAGE: 50</p>
 <p><b>5836</b> Phosphate</p> <p>#8 Screw Size Panel Range: .025"-.035" Ctr Of Hole To Edge: 3/8"</p> <p>UNIT PACKAGE: 100</p>	 <p><b>11768</b> (388248-S-36B) Phosphate</p> <p>#8 Screw Size Panel Range: .050"-.150" Ctr Of Hole To Edge: 9/32"</p> <p>UNIT PACKAGE: 50</p>	 <p><b>14814</b> (N803183-S32) Phosphate</p> <p>M4.2-1.41 (#8) Screw Size Panel Range: .094"-.156" Center Of Hole To Edge: 1/2"</p> <p>UNIT PACKAGE: 25</p>
 <p><b>2346</b> Phosphate</p> <p>#8 Screw Size Panel Range: .025"-.040" Ctr Of Hole To Edge: 9/32"</p> <p>UNIT PACKAGE: 100</p>	 <p><b>3778</b> Phosphate</p> <p>#8 Screw Size Panel Range: .035"-.051" Center Of Hole To Edge: 5/16"</p> <p>UNIT PACKAGE: 100</p>	 <p><b>18208</b> Phosphate</p> <p>#10 Screw Size Panel Range: .015"-.085" Center Of Hole To Edge: 11/32"</p> <p>UNIT PACKAGE: 100</p>
 <p><b>3796</b> (9428481) Zinc</p> <p>#8 Screw Size Panel Range: .025"-.040" Center Of Hole To Edge: 1/4"</p> <p>UNIT PACKAGE: 100</p>	 <p><b>19826</b> (382163-S) Phosphate</p> <p>#8 Screw Size Panel Range: .145"-.160" Center Of Hole To Edge: 9/32" <b>Replaces Auveco 11063</b></p> <p>UNIT PACKAGE: 50</p>	 <p><b>11429</b> Phosphate</p> <p>#10 Screw Size Panel Range: .015"-.060" Center Of Hole To Edge: 15/32"</p> <p>UNIT PACKAGE: 50</p>

For an assortment of “U” & “J” Nuts, see Fix-Kits 6007 & 6502 in the green pages.

**Sec. 9****“U” & “J” Type Nuts By Screw Size**

(ILLUSTRATIONS ACTUAL SIZE)

**2303**  
Phosphate#10 Screw Size  
Panel Range: .027"-.045"  
Center Of Hole To Edge: 3/16"

UNIT PACKAGE: 100

**5576**  
Phosphate#10 Screw Size  
Panel Range: .045"-.062"  
Center Of Hole To Edge: 13/32"

UNIT PACKAGE: 100

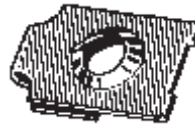
**2057**  
Phosphate#14 Screw Size  
Panel Range: .032"-.040"  
Center Of Hole To Edge: 1/2"

UNIT PACKAGE: 100

**3797**  
Phosphate#10 Screw Size  
Panel Range: .045"-.062"  
Center Of Hole To Edge: 13/32"

UNIT PACKAGE: 100

**8341**  
Phosphate#10 Screw Size  
Panel Range: .025"-.060"  
Center Of Hole To Edge: 11/32"

UNIT PACKAGE: 100

**2420**  
Phosphate#14 Screw Size  
Panel Range: .028"-.056"  
Center Of Hole To Edge: 15/32"

UNIT PACKAGE: 100

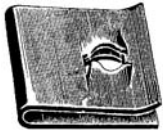
**1913**  
Phosphate#10 Screw Size  
Panel Range: .020"-.051"  
Center Of Hole To Edge: 15/32"

UNIT PACKAGE: 50

**19825**  
Phosphate#10 Screw Size  
Panel Range: .025"-.062"  
Center Of Hole To Edge: 9/32"  
**Replaces Auveco 8340**

UNIT PACKAGE: 50

**11767**  
Phosphate & Green#14 Screw Size  
License Plate Nut  
Panel Range: .140"-.187"  
Ctr. Of Hole To Edge: 25/32"  
Chrysler Omni & Horizon

UNIT PACKAGE: 15

**3770**  
Phosphate#10 Screw Size  
Panel Range: .030"-.037"  
Center Of Hole To Edge: 3/8"

UNIT PACKAGE: 100

**5197**  
Phosphate#10-24 Machine Screw Size  
Panel Range: .045"-.062"  
Center Of Hole To Edge: 9/16"

UNIT PACKAGE: 100

**2293**  
(9431647)  
Phosphate1/4"-20 Machine Screw Size  
Panel Range: .064"-.125"  
Center Of Hole To Edge: 9/16"

UNIT PACKAGE: 100

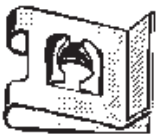
**2422**  
Phosphate#10 Screw Size  
Panel Range: .025"-.064"  
Center Of Hole To Edge: 3/8"

UNIT PACKAGE: 100

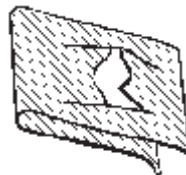
**1910**  
Phosphate#12 Screw Size  
Panel Range: .037"-.051"  
Center Of Hole To Edge: 1/2"

UNIT PACKAGE: 50

**1907**  
Phosphate5/16"-10 Tapping Screw Size  
Panel Range: .032"-.064"  
Center Of Hole To Edge: 1/2"

UNIT PACKAGE: 50



# SPRING TYPE "U" NUTS



**10064**  
Phosphate

#6 Screw Size  
Panel Range: .025"-.125"  
Center Of Hole To Edge: 3/8"

UNIT PACKAGE: 50



**10065**  
Phosphate

#8 Screw Size  
Panel Range: .025"-.125"  
Center Of Hole To Edge: 3/8"

UNIT PACKAGE: 25

**16267**

Same As 10065 Except For Unit Package Quantity

UNIT PACKAGE: 100



**9880**

(9424837, 9431530;  
381818-S2)  
Phosphate

#8 Screw Size  
Panel Range: .025"-.150"  
Center Of Hole To Edge: 3/8"  
GM, Ford

UNIT PACKAGE: 100



**9879**

(9440178, 11504531; 381863-S2)  
Phosphate

#8 Screw Size  
Panel Range: .025"-.150"  
Center Of Hole To Edge: 5/8"  
GM, Ford

UNIT PACKAGE: 100



**20582**  
(9433156)  
Phosphate

#8 Screw Size  
Panel Range: .125" - .250"  
Center Of Hole To Edge: 3/8"  
GM

UNIT PACKAGE: 100



**10066**  
Phosphate

#10 Screw Size  
Panel Range: .025"-.125"  
Center Of Hole To Edge: 11/32"

UNIT PACKAGE: 25



**15752**  
Phosphate

#10 Screw Size  
Panel Range: .025"-.150"  
Center Of Hole To Edge: 9/16"

UNIT PACKAGE: 50



**9881**

(9425491)  
Phosphate

#14 Screw Size  
Panel Range: .025"-.150"  
Center Of Hole To Edge: 5/16"  
GM

UNIT PACKAGE: 100



**16840**

(9433159,  
11514290)

Green Phosphate

#14 Screw Size  
Panel Range: .125".250"  
Center Of Hole To Edge: 11/32"

UNIT PACKAGE: 50



**10067**  
Phosphate

#14 Screw Size  
Panel Range: .025"-.125"  
Center Of Hole To Edge: 3/8"

UNIT PACKAGE: 25

# "U" TYPE SPECIAL NUTS



**14526**  
(N802538-S100)  
Green Phosphate

#8 Screw Size  
Panel Range: 1/16"-5/32"  
Center Of Hole To Edge: 5/16"  
17/32" Wide, 51/64" Long

Ford  
UNIT PACKAGE: 50



**14527**

(10041588,  
25530441)  
Phosphate

#8 Screw Size  
Panel Range: 1/16"-3/16"  
Center Of Hole To Edge: 19/32"  
35/64" Wide, 1-1/32" Long  
GM

UNIT PACKAGE: 50



**14750**

(Toyota: 53879-14010-A, 53879-14020,  
53879-22030; GM: 94841226;  
Mazda: LA01-56-135)

Nylon "U" Nut Fender/Wheel  
Housing Applications  
#10 Screw Size

20mm Wide  
31mm Long

Panel Range: Up to 1mm  
Center of Hole To Edge: 11mm  
Toyota, Geo Prizm & Nova  
And Mazda

UNIT PACKAGE: 15

**19669**

Same As 14750 Except For Packing

UNIT PACKAGE: 25

# Sec. 9

## "U" TYPE SPECIAL NUTS



**19160**  
Black Nylon

#8 (M4.2) Screw Size  
Panel Range: .040"-.165"  
(1.0mm-4.2mm)  
Center Of Hole To Edge:  
11/32" (9mm)  
Develops 8.2 Inch/Pound Drive  
Torque & Stop Torque of 30  
Inch/Pounds. Use Where Metal  
Fastener Would Not Be Appropriate  
Due To Electrical Or Chemical  
Resistance Requirements.

UNIT PACKAGE: 50

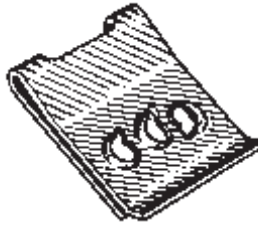

**19162**  
(1638575,  
25512688)  
Zinc

M4.2 (#8) Screw Size  
Panel Range: .035"-.049"  
Center Of Hole To Edge: 9/16"  
GM

UNIT PACKAGE: 25



**19165**  
Phosphate

M4.2 (#8) Screw Size  
Multi-Position "U" Nut  
Panel Range: Up To 5/64"  
Center of Hole to Edge: 25/64"  
3/4" Wide, 11/16" Long

UNIT PACKAGE: 25

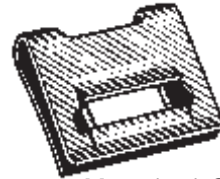

**19166**  
(1260888,  
25556911)  
Phos. & Blue

M4.2 (#8) Screw Size  
Multi-Position "U" Nut  
Panel Range: 1/16"-5/64"  
Center Of Hole To Edge: 7/16"  
Windshield Defroster Nozzle &  
Various Instrument Panel  
Applications  
GM 1984-On

UNIT PACKAGE: 25



**19809**  
(650870AA)  
Natural Nylon

#8 (M4.2) Screw Size  
Panel Range: 1mm-4.25mm  
Center Of Hole To Edge: 10mm  
Chrysler

UNIT PACKAGE: 25



**19163**  
Zinc

M4.2 (#8) Screw Size  
3 Position "U" Nut  
Panel Range: Up To 3/32"  
Center Of Hole To Edge: 15/32"  
27/32" Wide, 7/8" Long

UNIT PACKAGE: 25



**19164**  
Phosphate

M4.2 (#8) Screw Size  
4 Position "U" Nut  
Panel Range: Up To 5/32"  
Center Of Hole To Edge: 7/16"  
15/16" Wide, 29/32" Long

UNIT PACKAGE: 25

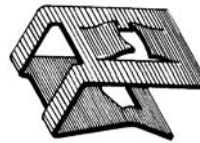

**10401**  
(545920,  
9837022)  
Phosphate

#8 Screw Size  
Panel Range: 3/16"  
Center Of Hole To Edge: 9/32"  
Headlight Bezel To Grille "U" Nut  
Front Side Marker, Radio/Tape  
Player & Various Instrument Panel  
Applications  
GM 1977-On

UNIT PACKAGE: 50



## "J" Type Cage Nuts Phosphate Finish

Auveco Part No.	Screw Size	Panel Range	Center Of Hole To Edge	Unit Pkg.
5586	1/4"-20 USS	.032-.093"	1/2"	50
3616	5/16"-18 USS	.087-.093"	15/32"	25
5589	5/16"-18 USS	.087-.093"	15/32"	50
5170	3/8"-16 USS	.050/.090"	9/16"	25

**EXTRUDED "U" NUTS**

(Foldover Nuts)



**10048**  
(45262)  
Phosphate

#8-32 Screw Size  
Panel Range: .025"-.150"  
Center Of Hole To Edge: 3/8"  
Ford

UNIT PACKAGE: 50



**15677**  
(152273)  
Phosphate

#10-24 Screw Size  
Panel Range: .025"-.125"  
Center Of Hole To Edge: 15/32"  
GM

UNIT PACKAGE: 50



**8375**  
(152266)  
Phosphate

5/16"-18 Screw Size  
Panel Range: .025"-.060"  
Center Of Hole To Edge: 9/16"  
GM

UNIT PACKAGE: 50



**18898**  
(45262)  
Phosphate

#8-32 Screw Size  
Panel Range: .079"-.118"  
Center Of Hole To Edge: 3/8"  
Ford

UNIT PACKAGE: 50



**8359**  
(1480627, 1494252)  
Phosphate

1/4"-20 Screw Size  
Panel Range: .025"-.150"  
Center Of Hole To Edge: 17/32"  
GM

UNIT PACKAGE: 50



**10053**  
(Chry: 6023171; Ford: 45264)  
Phosphate

5/16"-18 Screw Size  
Panel Range: .025"-.150"  
Center Of Hole To Edge: 9/16"  
Ford

UNIT PACKAGE: 50



**9429**  
(6025502)  
Phosphate

#8-32 Screw Size  
Panel Range: .040"-.080"  
Center Of Hole To Edge: 9/16"  
Chrysler

UNIT PACKAGE: 50



**10050**  
(45263-S2)  
Phosphate

1/4"-20 Screw Size  
Panel Range: .025"-.150"  
Center Of Hole To Edge: 17/32"  
Ford

UNIT PACKAGE: 25



**12265**  
(45264-S2)  
Phosphate

5/16"-18 Screw Size  
Panel Range: .040"-.125"  
Center Of Hole To Edge: 9/16"  
Ford

UNIT PACKAGE: 50



**10047**  
(45266-S2)  
Phosphate

#8-32 Screw Size  
Panel Range: .025"-.150"  
Center Of Hole To Edge: 9/16"  
Ford

UNIT PACKAGE: 50



**10051**  
(45267; 1494257)  
Phosphate

1/4"-20 Screw Size  
Panel Range: .025"-.150"  
Center Of Hole To Edge: 25/32"  
Ford, GM

UNIT PACKAGE: 50



**8377**  
(1480909)  
Phosphate

5/16"-18 Screw Size  
Panel Range: .060"-.090"  
Center Of Hole To Edge: 9/16"  
GM

UNIT PACKAGE: 50

**Sec. 9**

**EXTRUDED "U" NUTS**

(Foldover Nuts)



**8372**  
(152267)  
Phosphate

5/16"-18 Screw Size  
Panel Range: .120"-.150"  
Center Of Hole To Edge: 9/16"  
GM

UNIT PACKAGE: 50



**10830**  
(1494253)  
Phosphate

5/16"-18 Screw Size  
Panel Range: .025"-.150"  
Center Of Hole To Edge: 5/8"  
GM

UNIT PACKAGE: 50



**8814**  
(1494258;  
379831-S)  
Phosphate

5/16"-18 Screw Size  
Panel Range: .025"-.150"  
Center Of Hole To Edge: 27/32"  
GM, Ford

UNIT PACKAGE: 25



**10052**  
(10008002;  
45268-S2)  
Phosphate

5/16"-18 Screw Size  
Panel Range: .025"-.150"  
Center Of Hole To Edge: 7/8"  
GM, Ford

UNIT PACKAGE: 25



**10054**  
(1494254,  
12337873,  
45265-S2)  
Phosphate

3/8"-16 Screw Size  
Panel Range: .050"-.200"  
Center Of Hole To Edge: 3/4"  
GM, Ford

UNIT PACKAGE: 25



**10055**  
(45269)  
Phosphate

3/8"-16 Screw Size  
Panel Range: .050"-.200"  
Center Of Hole To Edge: 1-1/8"  
Ford

UNIT PACKAGE: 25

Inquire About Our  
FasTrack Cost Recovery  
Program For Body Shops

**Metric Extruded "U"**



**18337**  
(GM: 11500654;  
Ford: N623330-S2)  
Phosphate

M4-.7 Screw Size  
Panel Range: .60mm-3.8mm  
(.030"-.150")  
Center of Hole to Edge:  
9.5mm (3/8")  
GM, Ford

UNIT PACKAGE: 50



**11625**  
(11500655)  
Phosphate

M4-.7 Screw Size  
Panel Range: .80mm-4.00mm  
(.030"-.160")  
Center Of Hole To Edge:  
13.5mm (17/32")  
GM

UNIT PACKAGE: 50



**20339**  
(11516397)  
Zinc Organic

M4.2-1.41 (#8) Screw Size  
Locking Thread  
Panel Range: .5mm-2.0mm  
(.020"-.079")  
Ctr of Hole to Edge: 10mm (25/64")  
GM

UNIT PACKAGE: 50



**16841**  
(17988147)  
Phosphate  
& Paint

M4.2-1.41 (#8) Screw Size  
Locking Thread  
Panel Range: 2.0mm-3.0mm  
(.080"-.125")  
Cntr Of Hole To Edge: 9.5mm (3/8")  
GM

UNIT PACKAGE: 50

**EXTRUDED "U" NUTS**

(Foldover Nuts)



**18338**

(GM: 11505596;  
Ford: N623331-S2)  
Phosphate

M5-.8 Screw Size  
Panel Range: .60mm-3.8mm  
(.030"-.150")  
Cntr Of Hole To Edge: 11mm (7/16")  
GM, Ford

UNIT PACKAGE: 50



**11626**

(11500657)  
Phosphate

M5-.8 Screw Size  
Panel Range: .80mm-4.00mm  
(.030"-.160")  
Cntr Of Hole To Edge: 15.8mm (5/8")  
GM

UNIT PACKAGE: 50

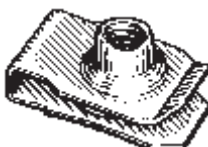

**16846**

(6502152)  
Phosphate

M6-1.0 Screw Size  
Tri-Lobular Locking Thread  
Panel Range: .80mm-4.00mm  
(.030"-.160")  
Cntr Of Hole To Edge: 12mm  
(15/32")  
Chrysler

UNIT PACKAGE: 50



**16842**

(11504047;  
N802331-S53)  
Phosphate

M6-1.0 Screw Size  
Panel Range: 3.4mm-6.3mm  
(.140"-.250")  
Center Of Hole To Edge:  
13.5mm (17/32")  
GM & Ford

UNIT PACKAGE: 25



**18449**

(6101308)  
Phosphate

M6-1.0 Screw Size  
Locking Thread  
Panel Range: .80mm-4.00mm  
(.030"-.160")  
Center Of Hole To Edge:  
13.5mm (17/32")  
Chrysler

UNIT PACKAGE: 50



**11864**

(11503714,  
11503716)  
Phosphate

M6-1.0 Screw Size  
Panel Range: .80mm-4.00mm  
(.030"-.160")  
Center Of Hole To Edge:  
13.5mm (17/32")  
GM

UNIT PACKAGE: 50



**12669**

1016937, 11503957;  
N623332-S2,  
-S53 & -S100)  
Phosphate

M6-1.0 Screw Size  
Panel Range: .80mm-4.00mm  
(.030"-.160")  
Center Of Hole To Edge:  
13.5mm (17/32")  
GM, Ford

UNIT PACKAGE: 25

"If a picture is worth  
1,000 words then a  
sample is worth 1,000  
pictures."

"Pop" Gale

Call our Customer  
Service Department When  
You Need A Sample



**18881**

(21095560)  
Zinc  
Cobalt Black

M6-1.0 Screw Size  
Panel Range: 3.5mm-4.0mm  
(.140"-.160")  
Ctr of Hole to Edge: 13.5mm (17/32")  
GM Saturn 1991-On

UNIT PACKAGE: 10



**12666**

(11504978)  
Zinc Organic

M6-1.0 Screw Size  
Panel Range: 1.0mm-5.0mm  
(.040"-.200")  
Ctr of Hole to Edge: 14.5mm (9/16")  
GM

UNIT PACKAGE: 25



**20416**

(11516372)  
Zinc Organic

M6-1.0 Screw Size  
Panel Range: 2.0mm-5.0mm  
(.079"-.197")  
Center Of Hole To Edge:  
14.5mm (9/16")  
GM

UNIT PACKAGE: 25



**19144**

(11505048)  
Black Phosphate

M6-1.0 Screw Size  
Panel Range: 3.4mm-6.3mm  
(.134"-.250")  
Center Of Hole To Edge:  
19mm (3/4")  
GM Saturn

UNIT PACKAGE: 15



**12575**

(11503715,  
11508241)  
Phosphate

M6-1.0 Screw Size  
Panel Range: .34mm-4.0mm  
(.015"-.160")  
Ctr of Hole to Edge: 19.5mm (25/32")  
GM

UNIT PACKAGE: 25

**EXTRUDED "U" NUTS**

(Foldover Nuts)



**16322**  
(14040999)  
Phosphate

M6-1.0 Screw Size  
Panel Range: 1.0mm-2.5mm  
(.045"-.095")  
Ctr of Hole to Edge: 19.5mm (25/32")  
GM

UNIT PACKAGE: 50

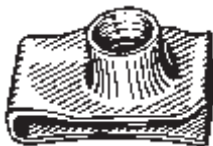

**12667**  
(11503455,  
11504288)  
Zinc Organic

M8-1.25 Screw Size  
Panel Range: .80mm-4.00mm  
(.030"-.160")  
Cntr of Hole to Edge: 14.5mm (9/16")  
GM

UNIT PACKAGE: 25



**19480**  
(N805889-S100)  
Phosphate

M6-1.0 Screw Size  
Panel Range: 4.3mm-5.6mm  
(.172"-.219")  
Center of Hole To Edge: 21mm  
(13/16")  
Ford

UNIT PACKAGE: 15

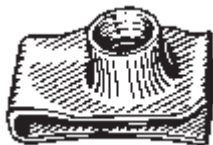

**11629**  
(11500660,  
11502617;  
N623333-S2; 6101283)  
Phosphate

M8-1.25 Screw Size  
Panel Range: .80mm-4.00mm  
(.030"-.160")  
Cntr of Hole to Edge: 14.5mm (9/16")  
GM, Ford, Chrysler

UNIT PACKAGE: 25



**11627**  
(11502785,  
11504035)  
Phosphate

M6.3-1.0 Screw Size  
Panel Range: .80mm-4.00mm  
(.030"-.160")  
Ctr of Hole to Edge: 13.5mm (17/32")  
GM

UNIT PACKAGE: 25



**11630**  
(11500661, 11503317, 11516150;  
N623343-S2 & S100)  
Phosphate

M8-1.25 Screw Size  
Panel Range: .80mm-4.50mm  
(.030"-.170")  
Ctr of Hole to Edge: 20mm (13/16")  
GM, Ford

UNIT PACKAGE: 25



**11628**  
(9433043,  
11500658)  
Phosphate

M6.3-1.0 Screw Size  
Panel Range: .80mm-4.00mm  
(.030"-.160")  
Ctr of Hole to Edge: 13.5mm (17/32")  
GM

UNIT PACKAGE: 25



**19644**  
(10084751)  
Phosphate

M8-1.25 Screw Size  
Panel Range: 1.7mm-5.5mm  
(.067"-.217")  
Ctr Of Hole To Edge: 28.5mm (1-1/8")  
GM

UNIT PACKAGE: 15

**EXTRUDED "U" NUTS**

(Foldover Nuts)



**19824**

(371964)  
Phosphate

M8-1.25 Screw Size  
Panel Range: 3.9mm-4.4mm  
(.156"-.172")  
Center of Hole To Edge:  
10mm (25/64")  
GM

UNIT PACKAGE: 25

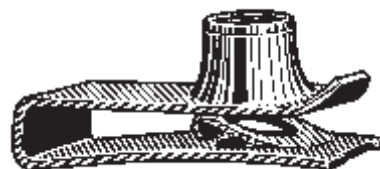

**18339**

(GM: 11500663; Ford: N623344-S2)  
Phosphate

M10-1.5 Screw Size  
Panel Range: 1.5mm-5.5mm  
(.060"-.215")  
Ctr of Hole to Edge: 28mm (1-3/32")  
GM, Ford

UNIT PACKAGE: 25



**18401**

(N801117-S100)  
Black Phosphate

M8-1.25 Screw Size  
Locking Thread  
Panel Range: 4mm-7mm  
(.157"-.276")  
Center of Hole to Edge: 21mm (13/16")  
Ford

UNIT PACKAGE: 25



**19901**

(11515614;  
W520815-S436)  
Phosphate

Rear Bumper Bracket

M12-1.75 Screw Size  
Panel Range: 1.5mm-5.5mm  
(.059"-.217")  
Center of Hole To Edge: 33mm (1-9/32")  
GM C & K Trucks 1988-On

UNIT PACKAGE: 4



**20447**

(N623334-S426)  
Zinc Organic

M10-1.5 Screw Size  
Panel Range: 1.5mm-5.5mm  
(.060"-.215")  
Ctr. Of Hole To Edge: 18mm (23/32")  
Ford

UNIT PACKAGE: 10



**19903**

Not Available From O.E.M.  
Phosphate

M12-1.75 Screw Size  
Panel Range: 3mm-7mm  
(.118"-.276")  
Center Of Hole To Edge: 42mm (1-21/32")  
Chrysler

UNIT PACKAGE: 5



**11631**

(11500662, 22531616)  
Phosphate

M10-1.50 Screw Size  
Panel Range: 1.0mm-6.0mm  
(.040"-.230")  
Center of Hole to Edge: 19mm (3/4")  
GM

UNIT PACKAGE: 25

# Sec. 10

# WASHERS



## Countersunk Type Washers



Screw Size	I.D.	O.D.	Nickel Plated Brass			Black Zinc Plated Brass		Plain Brass	
			Unit Pkg. 100	Unit Pkg. 144	Unit Pkg. 1000	Part No.	Unit Pkg.	Part No.	Unit Pkg.
#4	.9/64"	3/8"	612		7613			16590	100
#6	11/64"	7/16"	614	7143	7615	16011	100		
#8	13/64"	1/2"	616	7145	7616	16012	100	16592	100
#10	1/4"	19/32"	618	7147	7618	16013	100	16593	100
#12	9/32"	11/16"	619	7148				16594	100
#14	5/16"	25/32"	620	7149	7620				



## Flanged Type Countersunk Washers



Screw Size	I.D.	O.D.	Nickel On Brass Part No.	Black Zinc On Brass Part No.	Stainless Steel Part No.	Unit Pkg.
#6	5/32"	1/2"	3469		3470	100
#8	13/64"	5/8"	2515	16009	2597	100
#10	1/4"	11/16"	3471	16010	3472	100



## Flush Type Washers



Nickel Plated On Brass

Unit Pkg. 100	Unit Pkg. 144	Unit Pkg. 1000	Screw Size	I.D.	O.D.
602	7137	7624	#6	5/32"	11/32"
604	7138	7625	#8	3/16"	3/8"
16015		16016	#10	13/64"	15/32"

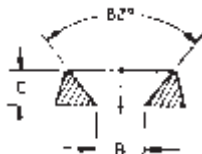
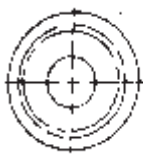

## Nylon Finishing Washers



Available in natural or black nylon, these molded washers protect cabinets from scratching, cover misaligned holes, etc. May also be used as guides, bumpers and spacers.

Auveco Part No.	Screw Size	O.D. (A)	I.D. (B)	Thickness (C)	Color	Unit Pkg.
13717	#6	.437" (11.10mm)	.143" (3.63mm)	.100" (2.54mm)	Black	50
13718	#8	.515" (13.08mm)	.171" (4.34mm)	.115" (2.92mm)	Natural	50
13719	#8	.515" (13.08mm)	.171" (4.34mm)	.115" (2.92mm)	Black	50
13720	#10	.580" (14.73mm)	.191" (4.85mm)	.152" (3.86mm)	Natural	50
13721	#10	.580" (14.73mm)	.191" (4.85mm)	.152" (3.86mm)	Black	50
13722	#12	.609" (15.47mm)	.225" (5.72mm)	.160" (4.06mm)	Natural	50
13723	#12	.609" (15.47mm)	.225" (5.72mm)	.160" (4.06mm)	Black	50
13724	#14	.683" (17.35mm)	.251" (6.38mm)	.183" (4.65mm)	Natural	50
13725	#14	.683" (17.35mm)	.251" (6.38mm)	.183" (4.65mm)	Black	50



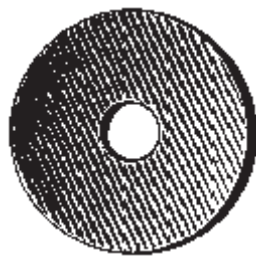

# WASHERS

## USS Washers

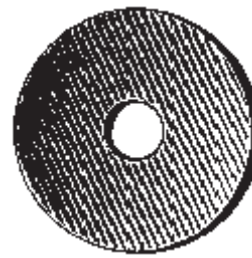

**Sec. 10**

Bolt Size	I.D.	O.D.	Thick-ness	Zinc Part No.	Plain Part No.	Unit Pkg.
3/16"	1/4"	9/16"	3/64"	<b>8605</b>	<b>3928</b>	100
1/4"	5/16"	3/4"	1/16"	<b>8606</b>	<b>3929</b>	100
5/16"	3/8"	7/8"	1/16"	<b>8607</b>	<b>3930</b>	100
3/8"	7/16"	1"	5/64"	<b>8608</b>	<b>3931</b>	100
7/16"	1/2"	1-1/4"	5/64"	<b>8609</b>	<b>3932</b>	100
1/2"	9/16"	1-3/8"	7/64"	<b>8610</b>	<b>3933</b>	100
9/16"	5/8"	1-1/2"	7/64"	<b>8611</b>		100
5/8"	11/16"	1-3/4"	9/64"	<b>8612</b>	<b>3935</b>	50*
3/4"	13/16"	2"	5/32"	<b>8613</b>	<b>8616</b>	50
7/8"	15/16"	2-1/4"	11/64"		<b>8617</b>	50

\* Unit Package quantity for 3935 is 100



## SAE Washers

Zinc



Auveco Part No.	Bolt Size	I.D.	O.D.	Thick-ness	Unit Pkg.
<b>3984</b>	#6 (1/8")	5/32"	3/8"	3/64"	100
<b>16721</b>	#8 (5/32")	3/16"	7/16"	3/64"	100
<b>3985</b>	#10 (3/16")	7/32"	1/2"	1/16"	100
<b>3986</b>	1/4"	9/32"	5/8"	1/16"	100
<b>3987</b>	5/16"	11/32"	11/16"	1/16"	100
<b>3988</b>	3/8"	13/32"	13/16"	1/16"	100
<b>3989</b>	7/16"	15/32"	15/16"	1/16"	100
<b>3990</b>	1/2"	17/32"	1-1/16"	3/32"	100
<b>3991</b>	9/16"	19/32"	1-3/16"	3/32"	100
<b>3992</b>	5/8"	21/32"	1-5/16"	3/32"	100
<b>3993</b>	3/4"	13/16"	1-1/2"	1/8"	100
<b>8621</b>	7/8"	29/32"	1-3/4"	1/8"	100

## High Strength Grade 8 Washers



Made in U.S.A.  
1035 Steel - R/C38-45 Hardness  
(For use with Grades 5 and 8 Bolts)  
Zinc & Gold Dichromate Finish



USS Sizes						SAE Sizes					
Auveco Part No.	Bolt Size	I.D.	O.D.	Thick-ness	Unit Pkg.	Auveco Part No.	Bolt Size	I.D.	O.D.	Thick-ness	Unit Pkg.
<b>12771</b>	1/4"	5/16"	3/4"	.051/.080"	100	<b>12781</b>	1/4"	9/32"	5/8"	.055/.072"	100
<b>12772</b>	5/16"	3/8"	7/8"	.064/.104"	100	<b>12782</b>	5/16"	11/32"	11/16"	.055/.072"	100
<b>12773</b>	3/8"	7/16"	1"	.064/.104"	100	<b>12783</b>	3/8"	13/32"	13/16"	.055/.072"	100
<b>12774</b>	7/16"	1/2"	1-1/4"	.064/.104"	50	<b>12784</b>	7/16"	15/32"	59/64"	.055/.072"	50
<b>12775</b>	1/2"	9/16"	1-3/8"	.097/.121"	50	<b>12785</b>	1/2"	17/32"	1-1/16"	.097/.121"	50
<b>12776</b>	9/16"	5/8"	1-1/2"	.097/.121"	25	<b>12786</b>	9/16"	19/32"	1-3/16"	.097/.121"	50
<b>12777</b>	5/8"	11/16"	1-3/4"	.108/.160"	25	<b>12787</b>	5/8"	11/16"	1-5/16"	.122/.146"	25
<b>12778</b>	3/4"	13/16"	2"	.122/.177"	10	<b>12788</b>	3/4"	13/16"	1-15/32"	.122/.146"	25
<b>12779</b>	7/8"	15/16"	2-1/4"	.136/.192"	10	<b>12789</b>	7/8"	15/16"	1-3/4"	.136/.160"	15
<b>12780</b>	1"	1-1/16"	2-1/2"	.136/.160"	10	<b>12790</b>	1"	1-1/8"	2"	.136/.160"	10

# Sec. 10

# WASHERS



## Spring Type Lock Washers

Grade 5  
Zinc

Auveco Part No.	Bolt Size	Unit Pkg.
5717	#6 (1/8")	200
5718	#8 (5/32")	200
5719	#10 (3/16")	200
5720	1/4"	200
5721	5/16"	200
5722	3/8"	200
5723	7/16"	200
5724	1/2"	200
8649	9/16"	100
8650	5/8"	100
14879	3/4"	50



## High Alloy Lock Washers

Grade 8  
(For use with Grade 5 & 8 Bolts)  
Zinc & Yellow Dichromate

Auveco Part No.	Bolt Size	Unit Pkg.
11925	1/4"	100
11926	5/16"	100
11927	3/8"	100
11928	7/16"	50
11929	1/2"	50
11931	5/8"	50
11932	3/4"	25
11933	7/8"	25
11934	1"	25

For Fastener Assortments refer to Assortments 1020 and 1030 in the green pages.



## Belleville Washers

Phosphate and Oil

Auveco Part No.	Bolt Size	I.D.	O.D.	Thick-ness	Unit Pkg.
14847	1/4"-6mm	.255"	.500"	.022"	50
14848	1/4"-6mm	.255"	.500"	.038"	50
14850	5/16"-8mm	.317"	.625"	.047"	50
14851	3/8"-10mm	.380"	.750"	.034"	25
14852	3/8"-10mm	.380"	.750"	.056"	25
14853	7/16"-11mm	.441"	.886"	.045"	25
14854	1/2"-12mm	.505"	1.00"	.050"	25



## Fender Washers

Zinc Plated

Auveco Part No.	Bolt Size	I.D.	O.D.	Thick-ness	Unit Pkg.
2007	3/16"	7/32"	1/2"	3/64"	100
1183	3/16"	7/32"	3/4"	3/64"	100
16018	3/16"	7/32"	1"	3/64"	100
16019	3/16"	7/32"	1-1/4"	3/64"	50
2008	1/4"	9/32"	5/8"	3/64"	100
16020	1/4"	9/32"	1"	1/16"	100
2333	1/4"	9/32"	1-1/4"	1/16"	100
16021	1/4"	9/32"	1-1/2"	3/64"	50
1376	5/16"	21/64"	3/4"	1/16"	100
768	5/16"	11/32"	1-1/4"	3/64"	100
17095	5/16"	11/32"	1-1/4"	1/8"	25
1700	5/16"	11/32"	1-1/2"	3/64"	50
3553	3/8"	13/32"	1-1/4"	1/16"	100
2227	3/8"	13/32"	1-1/2"	3/64"	50
16022	3/8"	27/64"	1-5/8"	1/16"	50
17094	3/8"	7/16"	1-3/4"	1/8"	25
3552	1/2"	17/32"	3/4"	3/64"	100
3554	1/2"	17/32"	1-1/4"	3/64"	100
3556	1/2"	17/32"	1-1/2"	3/64"	100
16023	1/2"	17/32"	2"	1/16"	25
3557	5/8"	11/16"	1-1/2"	3/64"	100

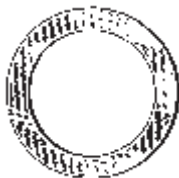

## Copper Washers

Auveco Part No.	Bolt Size	I.D.	O.D.	Thick-ness	Unit Pkg.
15911	3/16"	1/4"	7/16"	1/32"	50
15914	3/16"	1/4"	5/8"	1/16"	25
15912	1/4"	5/16"	1/2"	1/32"	50
15915	1/4"	5/16"	11/16"	1/16"	25
15913	5/16"	3/8"	9/16"	1/32"	50
15916	5/16"	3/8"	3/4"	1/16"	25
15917	3/8"	7/16"	13/16"	1/16"	25
15918	7/16"	1/2"	7/8"	1/16"	25
15919	1/2"	9/16"	13/16"	3/32"	25



## Bowed Spring Washers

Black Parkerized

Auveco Part No.	Bolt Size	I.D.	O.D.	Thick-ness	Unit Pkg.
9630	3/8"	25/64"	3/4"	1/64"	50

# WASHERS

## Nord Lock Vibration Proof Lock Washers

For Use With Grade 5 & Grade 8 Bolts  
Zinc & Yellow Chromate Plated

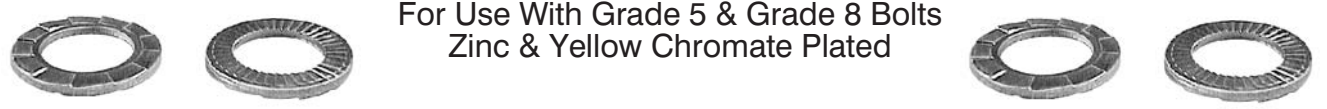

These washers have cams or wedges on one side, with a lead angle greater than a thread angle, and radial teeth or ribs on the other side. The washers are installed cam face to cam face. When tightening the fastener to preload, the teeth penetrate and seat against the joint material and the nut and/or fastener head. When subjected to vibration the interacting cams create a wedge action which prevents the fastener from vibrating loose.

Material: Carbon Steel  
Hardness: Through Hardened: Min. 44HRC, Max. 51 HRC

Auveco Part No.	Bolt Size	O.D.	Unit Pkg.
19282	3/16" (5mm)	11/32"	50 (25 pr.)
19283	1/4" (6mm)	27/64"	50 (25 pr.)
19284	5/16" (8mm)	17/32"	50 (25 pr.)
19285	3/8" (10mm)	21/32"	50 (25 pr.)
19286	7/16" (11mm)	23/32"	30 (15 pr.)
19287	1/2" (12mm)	49/64"	20 (10 pr.)
19288	9/16" (14mm)	29/32"	20 (10 pr.)
19289	5/8" (16mm)	1"	20 (10 pr.)
19290	3/4" (20mm)	1-7/32"	10 (5 pr.)
19291	1" (25mm)	1-17/32"	10 (5 pr.)

### Nord Lock Vibration Proof Lock Washer Kit



### Part No. 19313

The kit contains various quantities of the 10 different sizes (19282-19291) for a total of 156 nord lock washers in a durable translucent polypropylene box.

UNIT PACKAGE: 1



### External Lock Washers Zinc

Auveco Part No.	Bolt Size	O.D.	Unit Pkg.
5249	#4 (3/32")	1/4"	100
5250	#6 (1/8")	5/16"	100
5251	#8 (5/32")	3/8"	100
5252	#10 (3/16")	3/8"	100
5253	#12 (7/32")	15/32"	100
5254	#14 (1/4")	1/2"	100
5255	5/16"	19/32"	100
5256	3/8"	11/16"	100
5257	7/16"	3/4"	100
5258	1/2"	7/8"	100
16676	5/8"	1-1/32"	50
16677	3/4"	1-3/16"	50
16679	1"	1-9/16"	25



### Internal Lock Washers Zinc

Auveco Part No.	Bolt Size	O.D.	Unit Pkg.
5259	#4 (3/32")	1/4"	100
5260	#6 (1/8")	9/32"	100
5261	#8 (5/32")	5/16"	100
5262	#10 (3/16")	3/8"	100
5263	#12 (7/32")	13/32"	100
5264	#14 (1/4")	15/32"	100
5265	5/16"	19/32"	100
5266	3/8"	11/16"	100
5267	7/16"	25/32"	100
5268	1/2"	7/8"	100
16672	5/8"	1-1/16"	100
16673	3/4"	1-7/32"	50
16675	1"	1-19/32"	10



### Countersunk External Lock Washers Zinc

Auveco Part No.	Bolt Size	O.D.	Unit Pkg.
5270	#6 (1/8")	9/32"	100
5271	#8 (5/32")	5/16"	100
5272	#10 (3/16")	11/32"	100
5274	#14 (1/4")	7/16"	100

**"If a picture is worth 1,000 words then a sample is worth 1,000 pictures."**  
*"Pop" Gale*

**Call our Customer Service Department  
When You Need A Sample**

# Sec. 10

# WASHERS



## Internal-External Combination Lock Washers Zinc

Auveco Part No.	Bolt Size	O.D.	Unit Pkg.
17017	#6 (1/8")	1/2"	100
17018	#8 (5/32")	1/2"	100
17019	#10 (3/16")	9/16"	100
17020	#14 (1/4")	23/32"	100
17021	5/16"	7/8"	100
17022	3/8"	31/32"	100
17023	7/16"	1-1/32"	50
17024	1/2"	1-7/32"	50
17025	9/16"	1-19/32"	50
17026	5/8"	1-19/32"	25

## X-Washers

Zinc

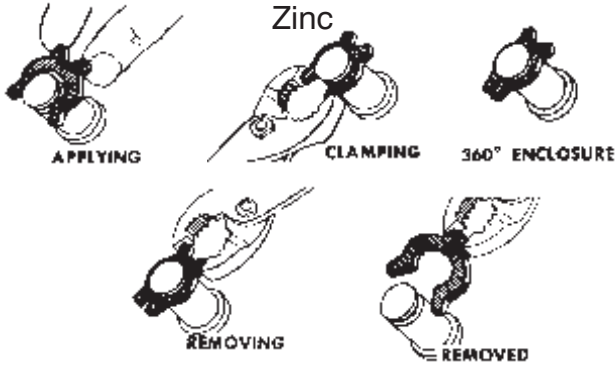

Auveco Part No.	Material A	Thickness	C	D	E	F	Unit Pkg.
13691	.086	.025	.320	.406	.210	.406	50
13692	.098	.055	.364	.490	.297	.475	50
13693	.130	.055	.438	.576	.338	.558	50
13694	.164	.065	.523	.687	.422	.665	50
13695	.190	.065	.593	.745	.437	.730	25
13696	.222	.075	.622	.776	.469	.775	25
13697	.256	.075	.698	.905	.500	.890	25
13698	.285	.075	.822	.986	.563	.984	25
13699	.317	.089	.872	1.100	.609	1.078	25
13701	.381	.089	1.060	1.297	.797	1.281	10

Commercial Tolerances All X-Washers

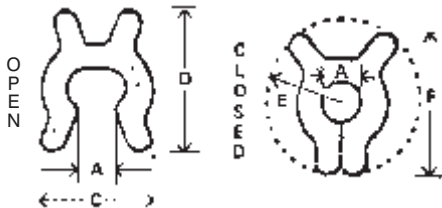

## Natural Nylon Flat Washers



Auveco Part No.	Bolt Size	I.D. ± .015	O.D. ± .015	Thick. ± .010	Unit Pkg.
13888	1/16"	.115"	.250"	.032"	100
13889	1/16"	.115"	.250"	.062"	100
13890	1/16"	.140"	.312"	.032"	100
13891	1/16"	.140"	.312"	.062"	100
13892	1/8"	.171"	.375"	.032"	100
13893	1/8"	.171"	.375"	.062"	100
13894	1/8"	.194"	.375"	.032"	100
13895	1/8"	.194"	.375"	.062"	100
13896	3/16"	.242"	.375"	.062"	100
13897	1/8"	.200"	.437"	.062"	100
13898	3/16"	.257"	.500"	.062"	100
13899	1/4"	.281"	.500"	.030"	100
13900	1/4"	.317"	.500"	.062"	100
13902	3/16"	.260"	.562"	.062"	100
13903	1/8"	.187"	.625"	.062"	50
13904	5/16"	.380"	.625"	.062"	50
13905	3/16"	.260"	.687"	.060"	50
13906	3/8"	.421"	.687"	.062"	50
13907	1/2"	.568"	.687"	.062"	50
13908	1/4"	.317"	.750"	.062"	50
13909	5/16"	.390"	.750"	.062"	50
13910	3/8"	.443"	.750"	.062"	50
13911	7/16"	.505"	.750"	.062"	50
13912	3/16"	.257"	.825"	.062"	50
13913	5/16"	.343"	.875"	.062"	50
13914	3/8"	.406"	1.000"	.062"	25
13916	7/16"	.516"	1.250"	.062"	25
13918	5/16"	.390"	1.260"	.062"	25
13919	7/16"	.500"	1.375"	.062"	25
13920	7/16"	.525"	1.375"	.125"	25
13921	5/8"	.665"	1.500"	.094"	25

Actual Size



13701

13699

13698



13691

13692

13693

13694

13695

13696

13697

**SHIMS**

(ILLUSTRATIONS ACTUAL SIZE)



1-1/4" x 1-1/8" w/ 3/8" Slot  
Zinc

**3155**

1/16" Thick

UNIT PKG: 100

**3156**

1/8" Thick

UNIT PKG: 100

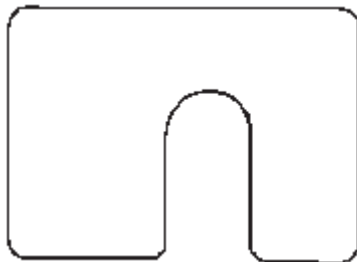

1-3/4" x 1-1/4" w/ 1/2" Slot  
Zinc

**2452**

1/16" Thick

UNIT PKG: 50

**2453**

1/8" Thick

UNIT PKG: 50

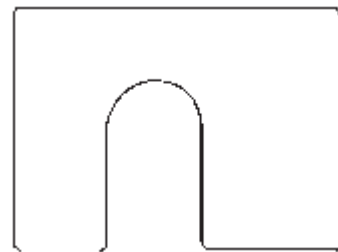

1-3/4" x 1-1/4" w/ 1/2" Slot  
Zinc

**8445**

1/8" Thick (10 Gauge Steel)

UNIT PACKAGE: 50

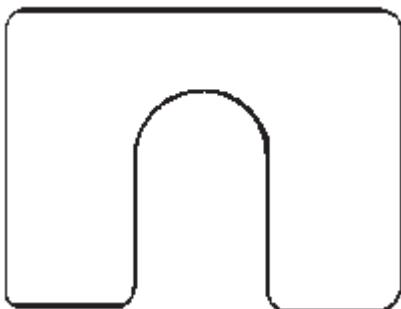

2" x 1-1/2" w/ 3/4" Slot  
Zinc

**3000**

1/8" Thick

UNIT PKG: 50

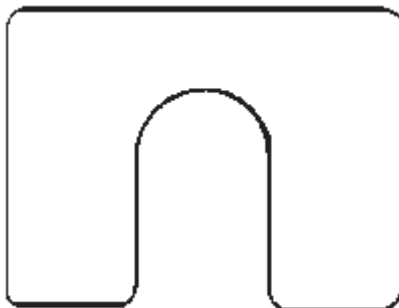

2" x 1-1/2" w/ 5/8" Slot  
Zinc

**2999**

1/8" Thick

UNIT PKG: 50

**Universal Alignment Shims**



1-3/16" x 1-15/32"

5/8" Slot  
Zinc

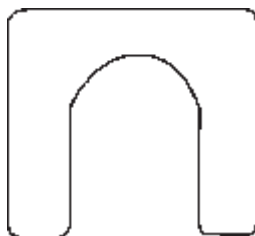

1-3/8" x 1-1/4" w/ 5/8" Slot  
Zinc

**20322**

1/8" Thick

UNIT PKG: 50

**20323**

3/16" Thick

UNIT PKG: 25



15/16" O.D. w/ 3/8" Slot

**20448**

1/16" Thick

UNIT PKG: 50

**20449**

1/8" Thick

UNIT PKG: 50

Auveco Part No.	Thickness	Unit Pkg.
<b>11186</b>	1/64"	25
<b>11187</b>	1/32"	25
<b>11188</b>	1/16"	25
<b>11189</b>	1/8"	25

For an assortment of Body and Fender Shims see Fix-Kit No. 6166 in the green pages.

**Sec. 10**

**CASTER AND CAMBER SHIMS**  
(ILLUSTRATIONS ACTUAL SIZE)

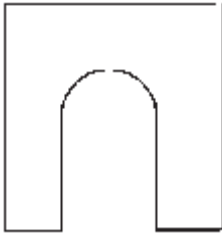

**Caster and Camber and Ball Joints Ford**

1-1/8" x 1-1/8"  
1/2" Slot  
Zinc

Auveco Part No.	Thickness	Unit Pkg.
5074.....	1/64"	.50
5075.....	1/32"	.50
5076.....	1/16"	.50
5077.....	1/8"	.50

**Caster and Camber Shims**

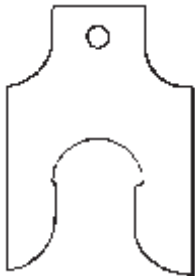

15/16" x 1-3/8"  
7/16" Bolt Opening  
Zinc

Auveco Part No.	Thickness	Unit Pkg.
5089.....	1/32"	.50
5090.....	1/16"	.50
5091.....	1/8"	.50

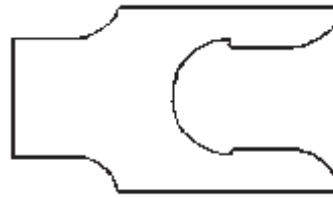

**Caster and Camber Shims GM**

1" x 1-11/16"  
37/64" Bolt Opening  
Zinc

Auveco Part No.	Thickness	Unit Pkg.
5093.....	1/32"	.50
5094.....	1/16"	.50
5095.....	1/8"	.50

**Caster and Camber Shims Chevrolet and GMC Trucks**

1-1/2" x 2-1/2"  
9/16" Slot  
Zinc

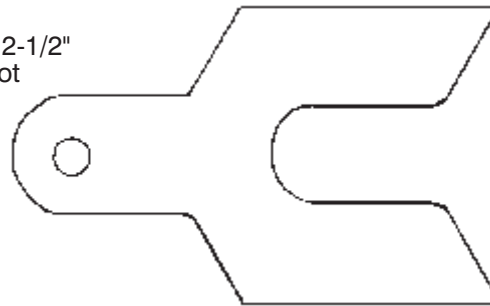

Auveco Part No.	Thickness	Unit Pkg.
5096.....	1/32"	.50
5097.....	1/16"	.50
5098.....	1/8"	.50

**Caster and Camber Shims GM Trucks**

1-1/4" x 2"  
17/32" Slot  
Zinc

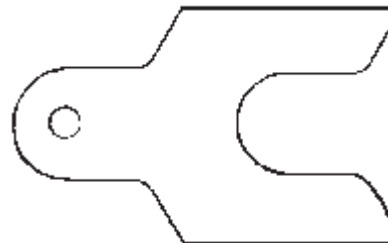

Auveco Part No.	Thickness	Unit Pkg.
5099.....	.3/16"	.50

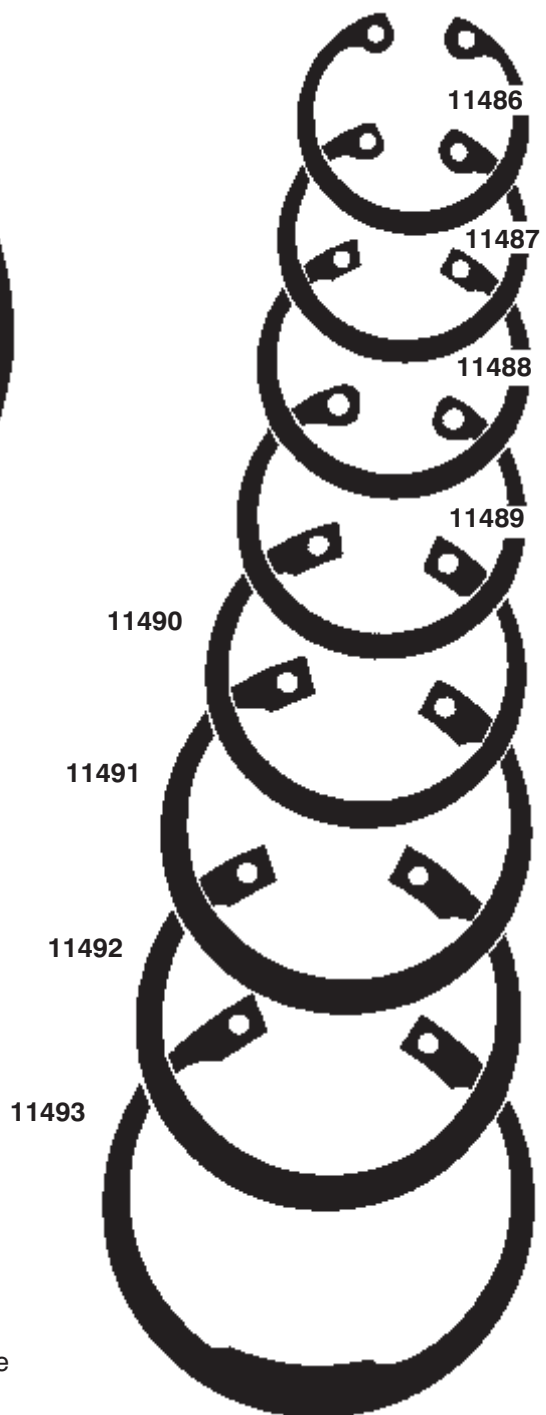
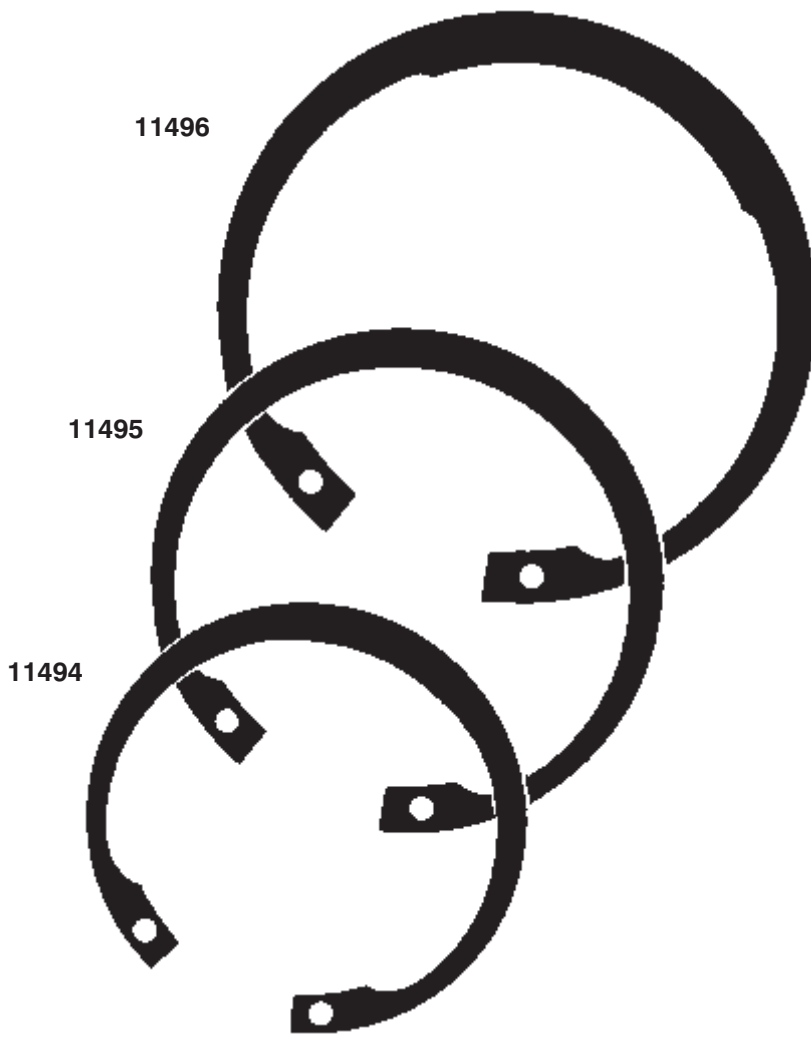

**Metric  
Basic Internal  
Retaining Rings**  
DIN 472 - 1300  
Groove Required In Bore  
Phosphate & Oil Finish

Auveco Part No.	Shaft Diameter		Groove Diameter		Groove Width		Unit Pkg.
	mm	Inches	mm	Inches	mm	Inches	
11486	26	1.024	27.2	1.072	1.30	.051	50
11487	28	1.104	29.4	1.158	1.30	.051	50
11488	30	1.181	31.4	1.237	1.30	.051	50
11489	32	1.260	33.7	1.328	1.30	.051	50
11490	35	1.378	37.0	1.457	1.60	.063	50
11491	40	1.575	42.5	1.675	1.85	.073	25
11492	42	1.654	44.5	1.753	1.85	.073	25
11493	47	1.850	49.5	1.950	1.85	.073	25
11494	52	2.047	55.0	2.165	2.15	.085	25
11495	62	2.441	65.0	2.559	2.15	.085	10
11496	72	2.835	75.0	2.953	2.65	.104	10

**Sec. 10**

**METRIC RETAINING RINGS**

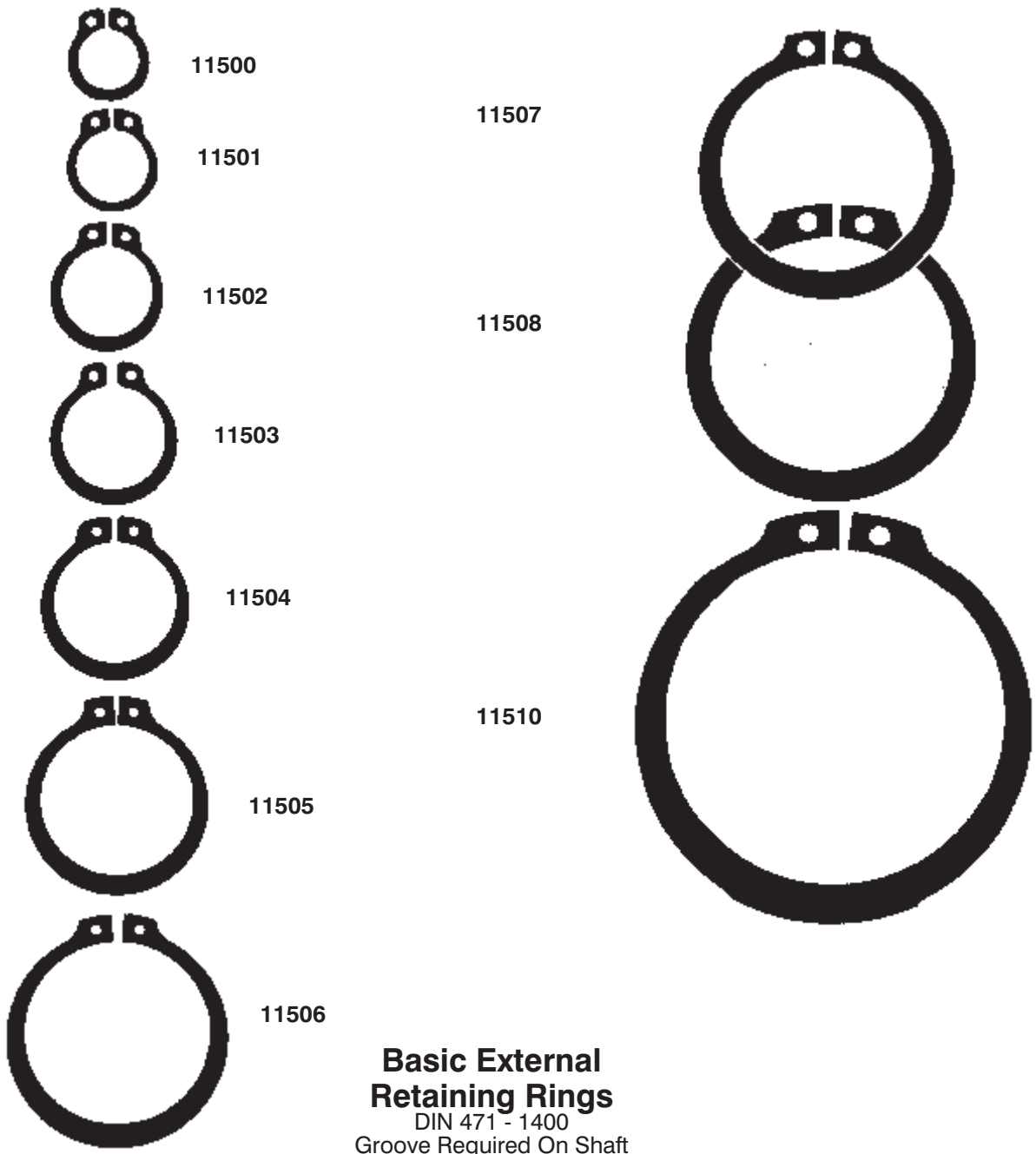

**Basic External Retaining Rings**  
 DIN 471 - 1400  
 Groove Required On Shaft  
 Phosphate & Oil Finish

Auveco Part No.	Shaft Diameter		Groove Diameter		Groove Width		Unit Pkg.
	mm	Inches	mm	Inches	mm	Inches	
11500	10.0	.394	9.6	.378	1.10	.043	100
11501	12.0	.472	11.5	.452	1.10	.043	100
11502	15.0	.591	14.3	.563	1.10	.043	100
11503	17.0	.670	16.2	.637	1.10	.043	50
11504	20.0	.787	19.0	.748	1.30	.051	50
11505	25.0	.985	23.9	.941	1.30	.051	50
11506	30.0	1.182	28.6	1.126	1.60	.063	50
11507	35.0	1.378	33.0	1.299	1.60	.063	50
11508	40.0	1.575	37.5	1.476	1.85	.073	25
11510	55.0	2.165	52.0	2.047	2.15	.085	10



# METRIC RETAINING RINGS

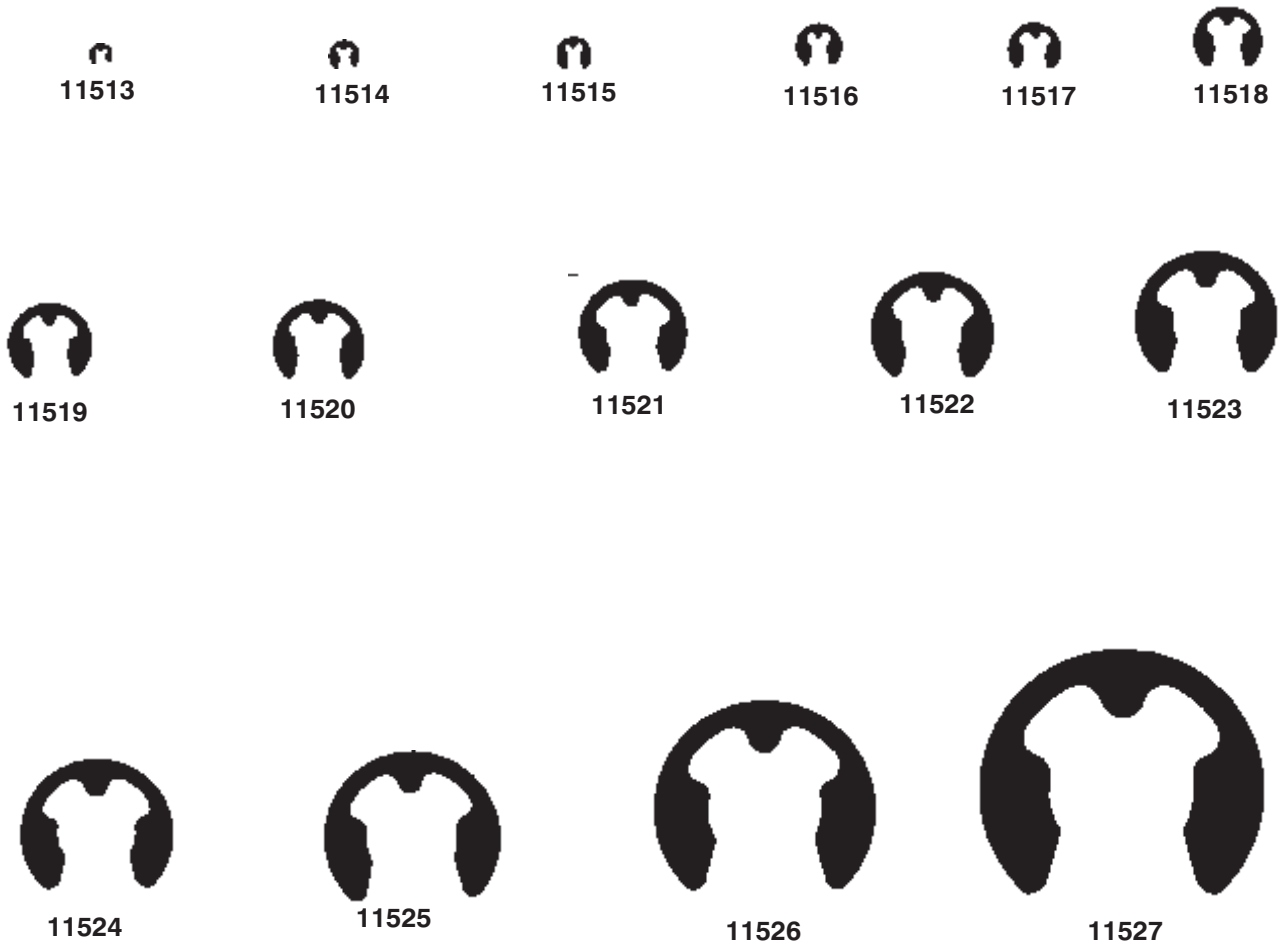

## “E” Type Retaining Rings

DIN 6799 - 1500  
Phosphate & Oil Finish

Auveco Part No.	Shaft Diameter		Groove Diameter		Groove Width		Unit Pkg.
	mm	Inches	mm	Inches	mm	Inches	
11513	1.4	.055	1.2	.047	0.34	.0134	100
11514	2.0	.079	1.5	.059	0.44	.0173	100
11515	2.5	.098	1.9	.075	0.54	.0213	100
11516	3.0	.118	2.3	.091	0.64	.0252	100
11517	4.0	.157	3.2	.126	0.64	.0252	100
11518	5.0	.197	4.0	.157	0.74	.0291	100
11519	6.0	.236	5.0	.197	0.74	.0291	100
11520	7.0	.276	6.0	.236	0.74	.0291	100
11521	8.0	.315	7.0	.276	0.94	.0370	100
11522	9.0	.354	8.0	.315	1.05	.0413	100
11523	10.0	.394	9.0	.354	1.15	.0453	100
11524	11.0	.433	10.0	.394	1.25	.0492	100
11525	13.0	.512	12.0	.472	1.35	.0532	100
11526	16.0	.630	15.0	.591	1.55	.0610	50
11527	20.0	.787	19.0	.748	1.85	.0728	50

# Sec. 10

## RETAINING RINGS

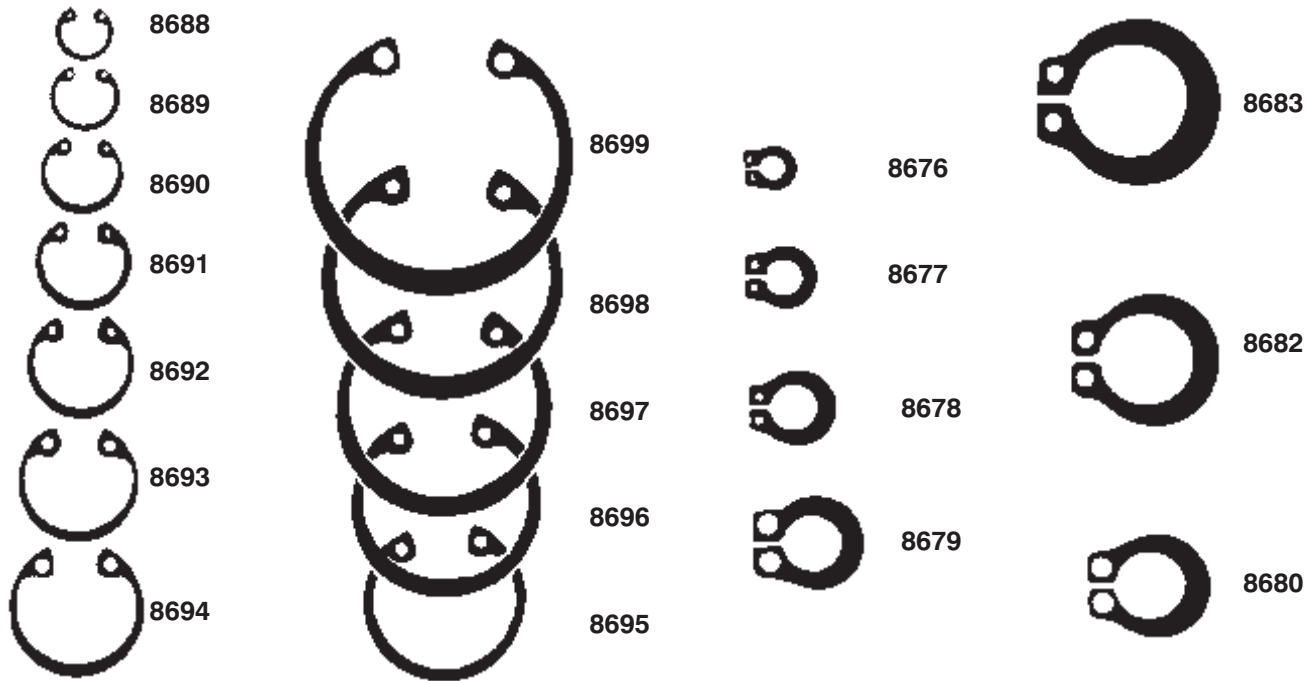

### Basic Internal Retaining Rings

Groove Required On Shaft  
Bright Zinc

Auveco Part No.	Housing Dia.	Groove Dia.	Groove Width	Unit Pkg.
8688	1/4"	.268"	.020"	50
8689	5/16"	.330"	.020"	50
8690	3/8"	.397"	.029"	50
8691	7/16"	.461"	.029"	50
8692	1/2"	.530"	.039"	50
8693	9/16"	.596"	.039"	50
8694	5/8"	.665"	.039"	50
8695	3/4"	.796"	.039"	50
8696	7/8"	.931"	.046"	50
8697	1"	1.066"	.046"	50
8698	1-1/8"	1.197"	.056"	50
8699	1-1/4"	1.330"	.056"	50

### External Grip Rings

No Groove Required  
Bright Zinc

Auveco Part No.	Shaft Diameter	Unit Pkg.
8676	1/8" - (.123 to .127 Shaft)	50
8677	3/16" - (.185 to .189 Shaft)	50
8678	1/4" - (.248 to .252 Shaft)	50
8679	5/16" - (.310 to .316 Shaft)	50
8680	3/8" - (.373 to .379 Shaft)	50
8682	1/2" - (.497 to .503 Shaft)	50
8683	5/8" - (.622 to .628 Shaft)	50

### Internal Self-Locking Retaining Rings



No Groove Required  
Bright Zinc

Auveco Part No.	Shaft Diameter	Unit Pkg.
8715	3/16" - (.184 to .192 Shaft)	100

# BASIC EXTERNAL RETAINING RINGS

**Sec. 10**

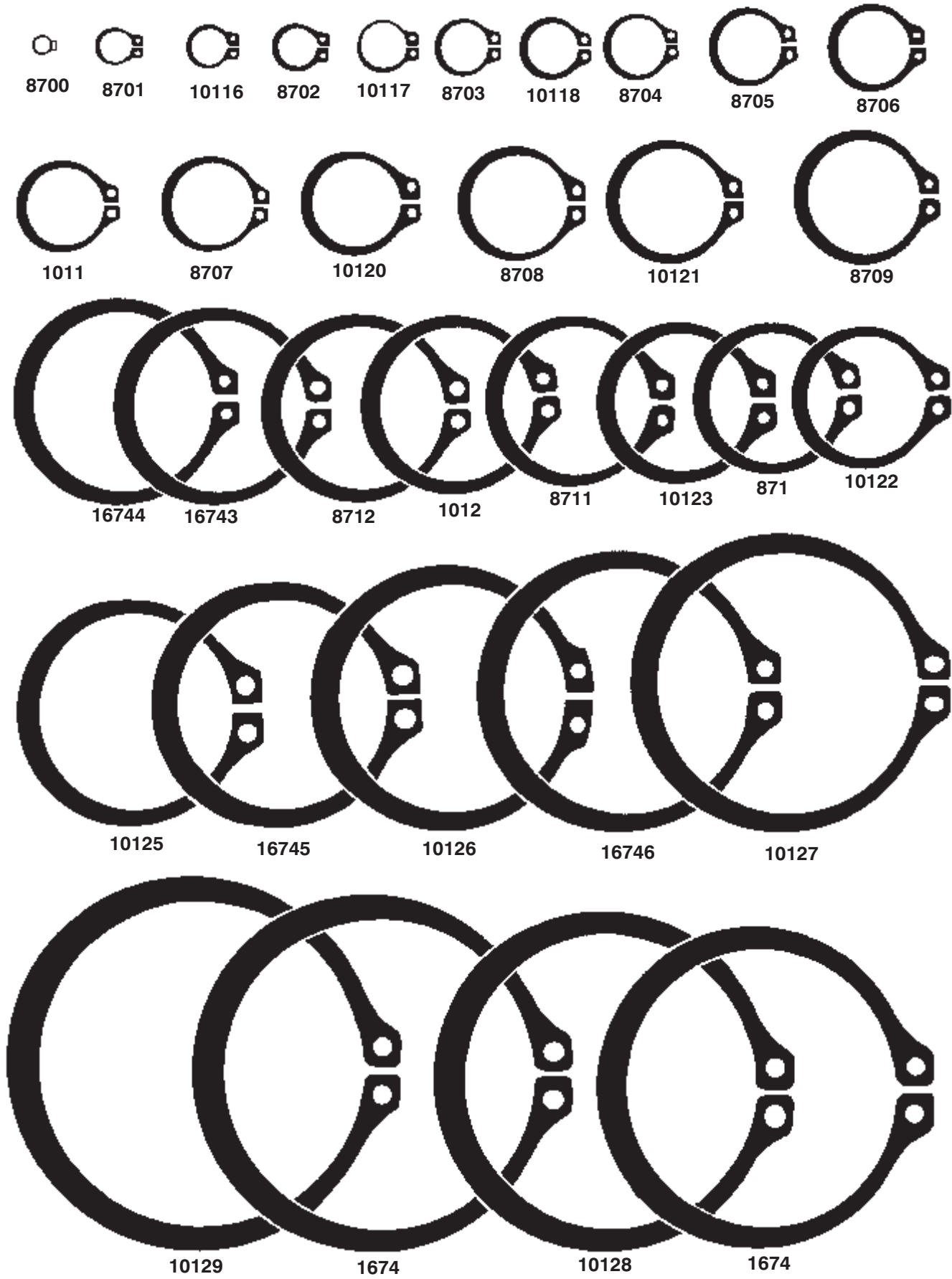

**Sec. 10**



**RETAINING RINGS**  
**Basic External Retaining Rings**

Groove Required On Shaft  
 Bright Zinc

Actual Size Illustrations On Previous Page.

Auveco Part No.	Shaft Diameter	Groove Diameter	Groove Width	Unit Pkg.	Auveco Part No.	Shaft Diameter	Groove Diameter	Groove Width	Unit Pkg.
8700	1/8"	.117"	.012"	50	8710	1"	.940"	.046"	50
8701	1/4"	.230"	.029"	50	10123	1-1/16"	.998"	.056"	50
10116	9/32"	.261"	.029"	50	8711	1-1/8"	1.059"	.056"	50
8702	5/16"	.290"	.029"	50	10124	1-3/16"	1.118"	.056"	50
10117	11/32"	.321"	.029"	50	8712	1-1/4"	1.176"	.056"	50
8703	3/8"	.352"	.029"	50	16743	1-5/16"	1.232"	.056"	50
10118	13/32"	.382"	.029"	50	16744	1-3/8"	1.291"	.056"	50
8704	7/16"	.412"	.029"	50	10125	1-1/2"	1.406"	.056"	25
8705	1/2"	.468"	.039"	50	16745	1-5/8"	1.529"	.068"	25
8706	9/16"	.530"	.039"	50	10126	1-3/4"	1.650"	.068"	25
10119	19/32"	.559"	.039"	50	16746	1-7/8"	1.769"	.068"	25
8707	5/8"	.588"	.039"	50	10127	2"	1.886"	.068"	10
10120	11/16"	.646"	.046"	50	16747	2-1/8"	2.003"	.086"	10
8708	3/4"	.704"	.046"	50	10128	2-1/4"	2.120"	.086"	10
10121	13/16"	.762"	.046"	50	16748	2-3/8"	2.239"	.086"	10
8709	7/8"	.821"	.046"	50	10129	2-1/2"	2.360"	.086"	10
10122	15/16"	.882"	.046"	50					

For an assortment of Basic Internal and External Retaining Rings see Kit No. 6116 and Large Drawer Assortment No. 6507

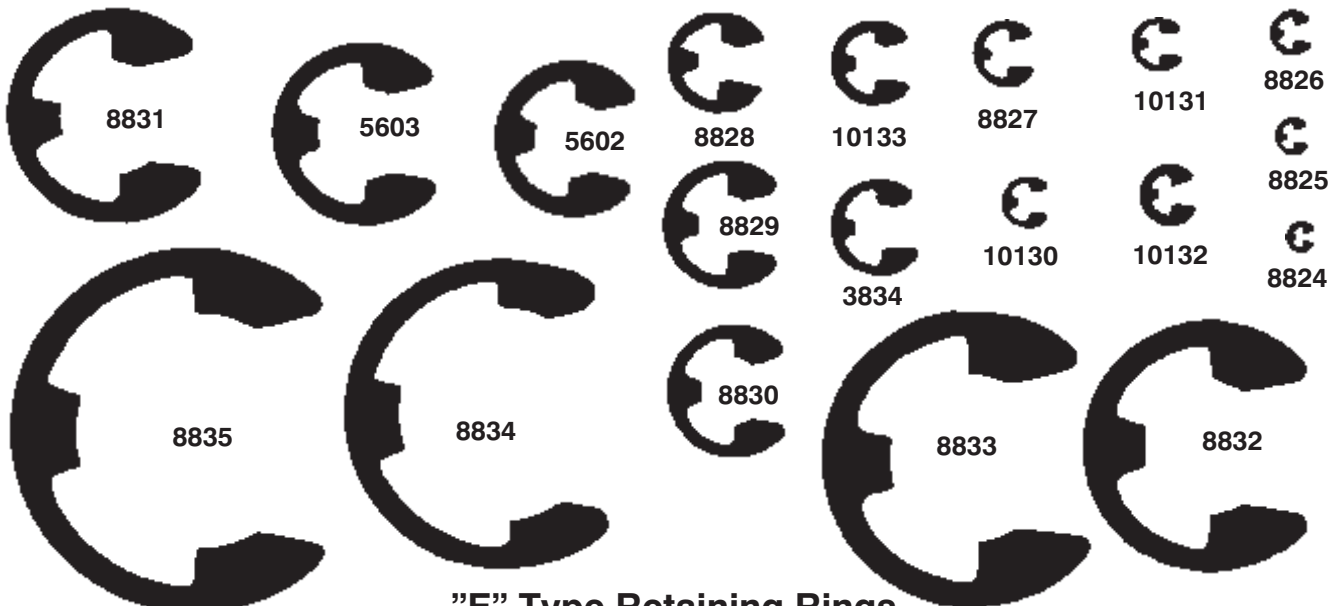

**"E" Type Retaining Rings**

Auveco Part No.	Shaft Dia.	Groove Dia.	Groove Width	Unit Pkg.	Auveco Part No.	Shaft Dia.	Groove Dia.	Groove Width	Unit Pkg.
8824	1/16"	.052"	.012"	100	8829	3/8"	.303"	.039"	100
8825	3/32"	.074"	.018"	100	8830	7/16"	.343"	.039"	100
8826	1/8"	.095"	.018"	100	5602	1/2"	.396"	.046"	100
10130	9/64"	.105"	.018"	100	5603	5/8"	.485"	.046"	100
10131	5/32"	.116"	.029"	100	8831	3/4"	.580"	.056"	50
10132	11/64"	.127"	.029"	100	8832	7/8"	.675"	.056"	50
8827	3/16"	.147"	.029"	100	8833	1"	.835"	.056"	50
10133	7/32"	.188"	.029"	100	8834	1-3/16"	1.079"	.068"	50
8828	1/4"	.210"	.029"	100	8835	1-3/8"	1.230"	.068"	50
3824	5/16"	.250"	.029"	100					

For an assortment of E and Reinforced E Type Retaining Rings see Kit No. 6086, 6123 and Large Drawer 6508.



## Reinforced "E" Type Retaining Rings

Auveco Part No.	Shaft Dia.	Groove Dia.	Groove Width	Unit Pkg.	Auveco Part No.	Shaft Dia.	Groove Dia.	Groove Width	Unit Pkg.
8836	3/32"	.074"	.018"	100	3628	5/16"	.250"	.039"	100
3165	1/8"	.095"	.018"	100	5600	3/8"	.303"	.039"	100
10134	5/32"	.116"	.029"	100	2672	7/16"	.343"	.039"	100
3166	3/16"	.147"	.029"	100	8837	1/2"	.396"	.046"	100
10135	7/32"	.188"	.029"	100	5601	9/16"	.437"	.046"	100
3167	1/4"	.210"	.029"	100					

For an Assortment of "E" and Reinforced E Type Retaining Rings see Kit No. 6086, 6123 and Large Drawer 6508

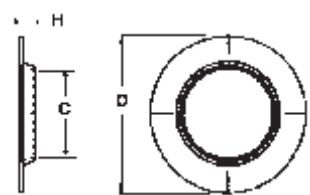

## Grooveless Retainer Ring 300 Series Stainless Steel

Auveco Part No.	Unit Pkg.	Stud Size	Outside Dia. (C)	Height (D)	Material Thickness (H)
14113	25	.375"	.625"	.030"	.010"

These Grooveless Retainer Rings press over studs, shafts or any round shape with a .375" diameter. They become an integral part of the axial application replacing snap or bearing rings and cotter pins. Designed without slots or shears, these rings will not "walk-off" or spring free.

## Convertible Retaining Ring Pliers For Internal and External Retaining Rings

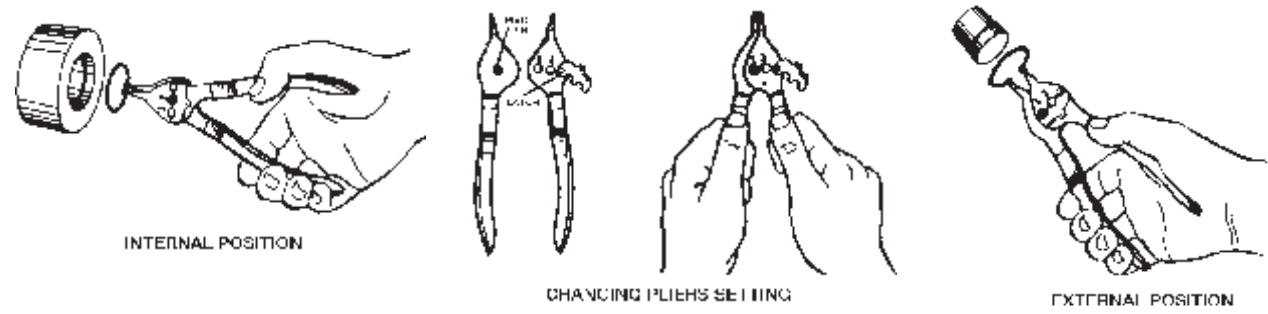

### 7909

Tip Diameter: .042"  
Use with Auveco Retaining Rings:  
8675 to 8678 (External)  
8688 to 8697 (Internal)  
8700 to 8709 (External)  
10116 to 10121 (External)  
UNIT PACKAGE: 1

### 7910

Tip Diameter: .070"  
Use With Auveco Retaining Rings:  
8679 to 8633 (External)  
8698 & 8699 (Internal)  
8710 to 8712 (External)  
10122 to 10129 (External)  
16743 to 16748 (External)  
UNIT PACKAGE: 1

**Sec. 10**

**SPRINGS**  
**Extension Springs**  
 Zinc



Auveco Part No.	Unit Pkg.	Type	Length Overall	Coil Length	O.D.	Wire Size	Lbs Rate/ Inch	Approx. Lbs Load @ Reference Ext.
14057	5	3	10"	9.000"	.625"	.072"	2.1	8.8 @ 13"
14058	5	3	10"	9.250"	.500"	.062"	1.8	10.2 @ 12"
14059	5	2	6.438"	5.575"	.438"	.048"	1.1	4.2 @ 8.437"
14060	5	1	6.500"	5.925"	.328"	.035"	7.5 oz.	2.2 @ 8.500"
14061	5	3	5.625"	4.975"	.547"	.080"	10.0	24 @ 7.625"
14062	5	1	5.750"	5.375"	.250"	.028"	7 oz.	1.6 @ 7.750"
14063	5	4	3.250"	2.750"	.375"	.041"	1.9	5.2 @ 5.250"
14064	5	1	4.00"	3.450"	.250"	.028"	13 oz.	1.9 @ 6.00"
14065	5	3	4.500"	3.575"	.484"	.063"	6.2	14 @ 6.500"
14066*	5	1	4.062"	2.750"	.734"	.062"	1.4	4.3 @ 6.062"
14067	5	3	4.00"	2.825"	.719"	.105"	12.5	36.5 @ 5.00"
14068	10	6	5.250"	3.000"	.531"	.062"	5.0	8.5 @ 6.250"
14069	5	5	2.594"	1.500"	.750"	.105"	46	29.5 @ 2.968"
14070	5	5	2.656"	1.500"	.750"	.080"	10.3	12.5 @ 3.656"
14072	10	3	1.438"	.825"	.344"	.048"	15.0	10 @ 1.812"
14074	10	3	1.125"	.700"	.234"	.020"	12.0	9 oz. @ 1.625"

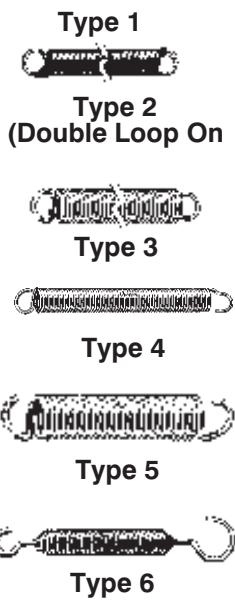

\* Not Zinc Plated

**Universal Springs**  
 Galvanized

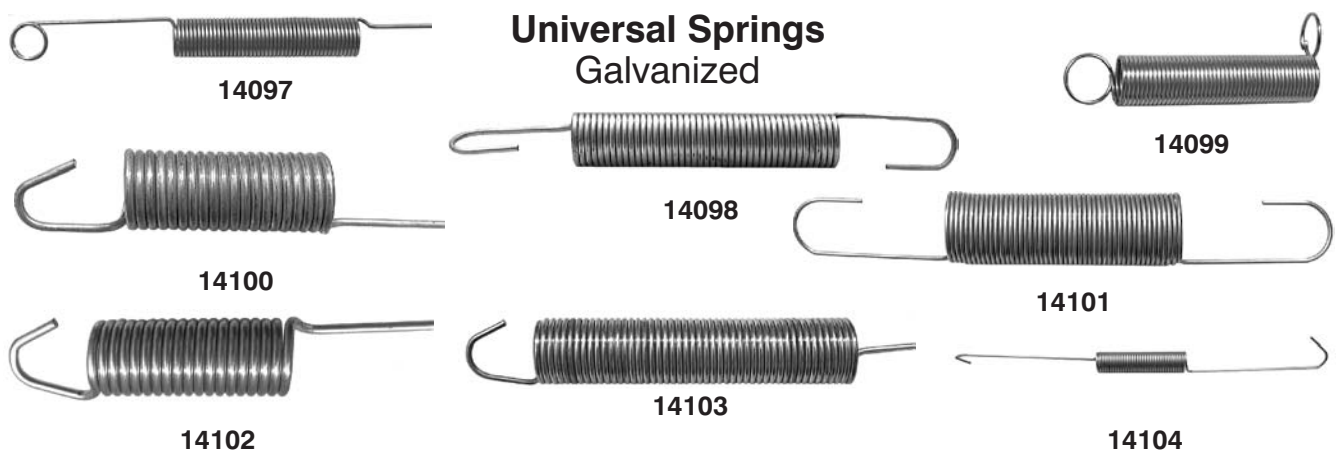

Auveco Part No.	Unit Pkg.	Length Overall	Coil Length	O.D.	Wire Size
14097	10	11-1/2"	1-7/8"	13/32"	1/32"
14098	10	4-3/8"	2-1/2"	1/2"	1/16"
14099	10	1-13/16"	1-1/2"	3/8"	1/32"
14100	10	8-1/2"	1-7/8"	3/4"	3/32"
14101	10	5-3/4"	2-3/8"	25/32"	3/64"
14102	10	18-1/2"	2"	13/16"	3/32"
14103	10	17-1/2"	3-1/2"	3/4"	1/16"
14104	10	8-1/4"	2"	7/16"	1/16"

# Springs, Pins & Clips

**Sec. 10**



## Compression Springs Zinc



Auveco Part No.	Unit Qty.	Length Overall	O.D.	Wire Size	Approx. Solid Ht.	Lbs. Rate/ Inch
<b>14077</b>	5	10.00"	.875"	.080"	3.00"	3.2
<b>14085</b>	5	3.062"	.875"	.092"	1.098"	21.5
<b>14088</b>	5	2.844"	.625"	.080"	1.080"	30.0
<b>14089</b>	20	2.193"	.590"	.040"	.380"	3.1
<b>14094*</b>	20	.781"	.375"	.042"	.378"	7.4
<b>14095</b>	10	2.625"	.438"	.048"	.950"	6.0
<b>14096</b>	10	2.500"	.500"	.063"	1.00"	18.0

\* Brass

### Throttle Rod Clips

Black Parkerized



Left-hand Type



Right-hand Type

Auveco Part No.	Rod Diameter	Ind. Std.	Unit Pkg.
<b>3609</b>	.5/32"	2	Right ..... 100
<b>3610</b>	.5/32"	2	Left ..... 100
<b>3611</b>	3/16"	4	Right ..... 100
<b>3612</b>	3/16"	4	Left ..... 100
<b>3613</b>	1/4"	7	Right ..... 100
<b>3614</b>	1/4"	7	Left ..... 100

For an assortment of Throttle Rod Clips see Kit No. 6086.

### Retainer Pins

Zinc



Auveco Part No.	Inside Diameter	Overall Length	Wire Dia.	Unit Pkg.
<b>9114</b>	.....1/16"	.....3/8"	......035"	.....100
<b>9894</b>	.....1/16"	.....19/32"	......045"	.....100
<b>10389</b>	.....3/32"	.....37/64"	......045"	.....100
<b>10390</b>	.....7/64"	.....3/4"	......050"	.....100
<b>9113</b>	.....1/8"	.....1/2"	......030"	.....100
<b>10388</b>	.....1/8"	.....9/16"	......070"	.....100
<b>9112</b>	.....1/8"	.....1-1/8"	......070"	.....100
<b>9111</b>	.....5/32"	.....7/8"	......050"	.....100
<b>9110</b>	.....3/16"	.....1-3/16"	......070"	.....100

### Hair Pin Cotters



Auveco Part No.	Inside Diameter	Overall Length	Wire Diameter	Unit Pkg.
<b>3168</b>	.....1/16"	.....23/64"	......025"	.....200
<b>9890</b>	.....3/32"	.....3/8"	......025"	.....100
<b>3173</b>	.....1/8"	.....31/64"	......045"	.....200

Auveco Part No.	Inside Diameter	Overall Length	Wire Diameter	Unit Pkg.
<b>3176</b>	.....5/32"	.....5/8"	......045"	.....200
<b>2598</b>	.....7/32"	.....3/4"	......060"	.....100
<b>9892</b>	.....5/16"	.....1"	......060"	.....100

**Sec. 10**

**HAIR PIN COTTERS**

(ILLUSTRATIONS ACTUAL SIZE)

Zinc

Auveco Part No.	Wire Dia.	Drill Hole Size	Min. Shaft Dia.	Max. Shaft Dia.	Overall Length	Inside Dia. Of Eye	Unit Pkg.
16934	.042" (3/64")	3/64"	3/16"	1/4"	1"	1/4"	100
16727	.080" (5/64")	3/32"	1/4"	3/8"	1-3/16"	1/4"	100
11872	.080" (5/64")	3/32"	3/8"	1/2"	1-9/16"	5/16"	100
10391	.080" (5/64")	3/32"	3/8"	1/2"	1-9/16"	5/16"	100
11873	.062" (1/16")	5/64"	3/8"	1/2"	1-9/16"	5/16"	100
10392	.062" (1/16")	5/64"	3/8"	1/2"	1-9/16"	5/16"	100
10393	.125" (1/8")	9/64"	1/2"	3/4"	1-15/16"	7/16"	50
11874	.125" (1/8")	9/64"	1/2"	3/4"	1-15/16"	7/16"	50
10394	.093" (3/32")	7/64"	1/4"	5/8"	2-5/16"	5/8"	50
10395	.125" (1/8")	9/64"	5/8"	7/8"	2-1/2"	1/2"	25
10396	.177" (3/16")	3/16"	7/8"	1-1/4"	3-3/4"	7/8"	10
10398	.243" (1/4")	17/64"	3/4"	1"	4"	15/16"	10
10397	.310" (5/16")	21/64"	7/8"	1"	3-15/16"	7/8"	5

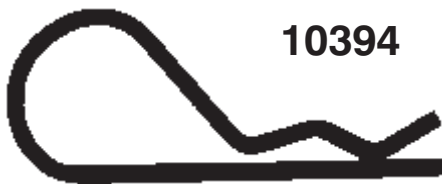

**10394**



**16934**



**10395**



**16727**



**11872**



**10396**



**10391**



**11873**



**10398**



**10392**



**10397**



**10393**



**11874**



**PINS**

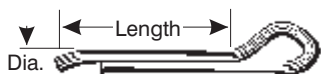

**Cotter Pins  
Hammer-Lock Type  
C 1008 Steel**

Auveco Part No. Plated	Auveco Part No. Plain	Size	Unit Pkg.
8477	3502	1/16" x 1/2"	200
8478	3503	1/16" x 3/4"	200
8479	3504	1/16" x 1"	200
14901	3505	1/16" x 1-1/4"	200
8480	3506	1/16" x 1-1/2"	200
14902	3508	1/16" x 2"	200
14903	3509	3/32" x 1/2"	200
8481		3/32" x 3/4"	200
8482	3511	3/32" x 1"	200
8483	3512	3/32" x 1-1/4"	200
8484	3513	3/32" x 1-1/2"	200
8485	3515	3/32" x 2"	200
14904	3519	1/8" x 3/4"	200
8486	3520	1/8" x 1"	200
8487	3521	1/8" x 1-1/4"	200
8488	3522	1/8" x 1-1/2"	200
8489		1/8" x 1-3/4"	200
8490	3524	1/8" x 2"	200
8491	3526	1/8" x 2-1/2"	200
8492		5/32" x 1"	100
14905	8506	5/32" x 1-1/4"	100
8493	8507	5/32" x 1-1/2"	100
14906	8508	5/32" x 1-3/4"	100
8494	8509	5/32" x 2"	100
14907	8511	5/32" x 2-1/2"	100
14908		5/32" x 3"	100
14909		3/16" x 1"	100
14910		3/16" x 1-1/4"	100
8495	8516	3/16" x 1-1/2"	100
8496	8518	3/16" x 2"	100
8497		3/16" x 2-1/2"	100
14911	8521	3/16" x 3"	100
8498		1/4" x 1-1/2"	100
8499		1/4" x 2"	100
8500		1/4" x 2-1/2"	100
8501	8530	1/4" x 3"	100
14912	8532	1/4" x 4"	100
8502		5/16" x 2-1/2"	50
8503		5/16" x 3"	50

For assortments of Cotter Pins see Fix-Kit Assortment Nos. 6051, 6110, 6112, 6113 and Large Drawer (6500 Series) No. 6506



**Lynch Pins  
Zinc**

Auveco Part No.	Pin Size	Ring I.D.	Ring O.D.	Unit Pkg.
11733*	7/16" O.D. x 2-1/4" Long (With Rings)	1-3/4"	1-15/16"	5
11736*	1/4" O.D. x 2-1/8" Long (With Rings)	1-5/8"	1-7/8"	10

\*Pin Extends Beyond Ring



**Clevis Pins  
Drilled For Cotter Pins  
Zinc**

Auveco Part No.	Dia.	Use Pin Dia.	Length Under Head to Ctr of Hole	Length Under Head to End of Pin
9433	1/4"	1/16"	29/32"	1"
9434	1/4"	1/16"	1"	1-1/8"
9435	5/16"	3/32"	7/8"	1"
9436	5/16"	3/32"	1"	1-1/8"
9437	5/16"	3/32"	1-1/8"	1-1/4"
9438	5/16"	3/32"	1-1/4"	1-3/8"
9439	5/16"	3/32"	1-5/8"	1-3/4"
9440	3/8"	3/32"	7/8"	1"
9441	3/8"	3/32"	1"	1-1/8"
9442	3/8"	3/32"	1-1/16"	1-3/16"
9443	3/8"	3/32"	1-1/8"	1-1/4"
9444	3/8"	3/32"	1-3/8"	1-1/2"
9445	3/8"	3/32"	1-5/8"	1-3/4"
9446	1/2"	1/8"	1-11/32"	1-1/2"
9447	1/2"	1/8"	1-19/32"	1-3/4"

UNIT PACKAGE: 25

For an assortment of Clevis Pins see Fix Kit No. 6139

**Universal Clevis Pins  
Zinc**



Auveco Part No.	Size	Use Cotter Pin Dia.	No. of Holes	Unit Pkg.
3703	1/4" x 2"	3/32"	6	10
3704	5/16" x 2"	3/32"	6	10
3705	3/8" x 2"	3/32"	6	10
3706	7/16" x 2"	3/32"	6	10
3708	7/16" x 2-1/2"	3/32"	7	10
8264	7/16" x 3"	3/32"	7	10
3707	1/2" x 2"	1/8"	6	10
3709	1/2" x 2-1/2"	1/8"	7	10
8265	1/2" x 3"	1/8"	7	10

For an assortment of Universal Clevis Pins see Fix-Kit No. 6060 in the green pages.

# Sec. 10

# YOKE ENDS & SPRING PINS

Yoke Ends

Drop Forged • Adjustable • Zinc Finish

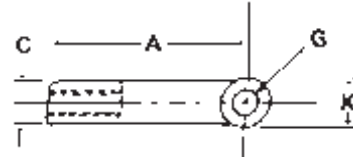
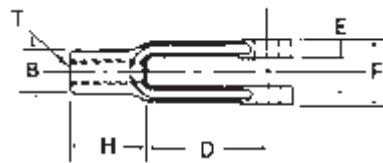

Auveco Part No.	"T" Tap Size	A	B	C	D	E	F	G	H	K	Unit Pkg.
10737	1/4"-28	2"	7/16"	7/16"	1-1/4"	9/32"	5/8"	1/4"	3/4"	1/2"	10
10788	1/4"-28	2"	7/16"	7/16"	1-1/4"	9/32"	5/8"	1/4"	3/4"	1/2"	2
10738	5/16"-24	2-1/4"	1/2"	1/2"	1-7/16"	11/32"	3/4"	5/16"	13/16"	19/32"	10
10789	5/16"-24	2-1/4"	1/2"	1/2"	1-7/16"	11/32"	3/4"	5/16"	13/16"	19/32"	2
10739	3/8"-24	2-1/2"	5/8"	5/8"	1-5/8"	7/16"	7/8"	3/8"	7/8"	11/16"	10
10790	3/8"-24	2-1/2"	5/8"	5/8"	1-5/8"	7/16"	7/8"	3/8"	7/8"	11/16"	2
10740	7/16"-20	2-7/8"	23/32"	23/32"	1-7/8"	1/2"	1"	7/16"	1"	13/16"	10
10791	7/16"-20	2-7/8"	23/32"	23/32"	1-7/8"	1/2"	1"	7/16"	1"	13/16"	2
10741	1/2"-20	3"	13/16"	13/16"	1-7/8"	9/16"	1-1/8"	1/2"	1-1/8"	15/16"	10
10792	1/2"-20	3"	13/16"	13/16"	1-7/8"	9/16"	1-1/8"	1/2"	1-1/8"	15/16"	2
10742	5/8"-18	4-15/16"	1-1/16"	1-1/16"	3-11/16"	11/16"	1-3/8"	5/8"	1-1/4"	1-3/16"	10
10793	5/8"-18	4-15/16"	1-1/16"	1-1/16"	3-11/16"	11/16"	1-3/8"	5/8"	1-1/4"	1-3/16"	2



## Spring Pins

Zinc



Auveco Part No.	Dia	Length	Wall Thick.	Unit Pkg.	Auveco Part No.	Dia.	Length	Wall Thick.	Unit Pkg.
8981	1/16"	3/16"	.012"	50	9018	5/32"	1-1/2"	.032"	50
8983	1/16"	1/2"	.012"	50	9019	3/16"	1/2"	.040"	50
8985	1/16"	3/4"	.012"	50	9021	3/16"	3/4"	.040"	50
8987	1/16"	1"	.012"	50	9022	3/16"	1"	.040"	50
8988	5/64"	1/4"	.018"	50	9023	3/16"	1-1/4"	.040"	50
8989	5/64"	1/2"	.018"	50	9024	3/16"	1-1/2"	.040"	50
8990	5/64"	9/16"	.018"	50	9025	3/16"	1-3/4"	.040"	50
8991	5/64"	3/4"	.018"	50	9026	3/16"	2"	.040"	50
8992	5/64"	1"	.018"	50	9027	7/32"	5/8"	.048"	50
8993	5/64"	1-1/4"	.018"	50	9028	7/32"	1-3/8"	.048"	50
8994	5/64"	1-1/2"	.018"	50	9029	7/32"	1-3/4"	.048"	50
8995	3/32"	5/16"	.022"	50	9030	1/4"	5/8"	.050"	50
8996	3/32"	1/2"	.022"	50	9031	1/4"	3/4"	.050"	50
8997	3/32"	5/8"	.022"	50	9033	1/4"	1"	.050"	50
8998	3/32"	3/4"	.022"	50	9034	1/4"	1-1/4"	.050"	50
8999	3/32"	7/8"	.022"	50	9035	1/4"	1-1/2"	.050"	50
9000	3/32"	1"	.022"	50	9036	1/4"	1-3/4"	.050"	50
9001	3/32"	1-1/4"	.022"	50	9037	1/4"	2"	.050"	50
9002	3/32"	1-1/2"	.022"	50	9038	1/4"	2-1/4"	.050"	50
9003	1/8"	3/8"	.028"	50	9039	1/4"	2-1/2"	.050"	50
9004	1/8"	1/2"	.028"	50	9040	5/16"	3/4"	.062"	50
9005	1/8"	5/8"	.028"	50	9042	5/16"	1"	.062"	50
9006	1/8"	3/4"	.028"	50	9043	5/16"	1-1/2"	.062"	50
9007	1/8"	7/8"	.028"	50	9044	5/16"	1-3/4"	.062"	25
9008	1/8"	1"	.028"	50	9045	5/16"	2"	.062"	25
9009	1/8"	1-1/4"	.028"	50	9046	5/16"	2-1/2"	.062"	25
9010	1/8"	1-1/2"	.028"	50	9047	3/8"	3/4"	.077"	25
9011	1/8"	1-3/4"	.028"	50	9048	3/8"	1"	.077"	25
9012	1/8"	2"	.028"	50	9049	3/8"	1-1/2"	.077"	25
9013	5/32"	1/2"	.032"	50	9050	3/8"	2"	.077"	25
9015	5/32"	3/4"	.032"	50	9051	3/8"	2-1/2"	.077"	25
9016	5/32"	1"	.032"	50					
9017	5/32"	1-1/4"	.032"	50					

For Spring Pin Assortments see Kits 6124, 6125 and Large Drawer (6500 Series) Assortment No. 6509 and 6510.

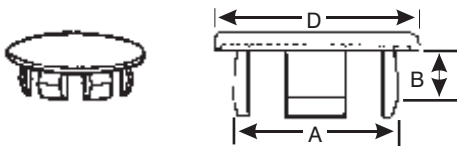

**PLUG BUTTONS**

Nylon 6/6 Matte Finish

Auveco Part No.	Hole Size (A)	Panel Thickness (B)	Head Size (D)	Head Height	Color	Unit Pkg.
13862	.3/16"	1/32"-9/64"	11/32"	.040"	Natural	100
13863	.3/16"	1/32"-9/64"	11/32"	.040"	Black	100
13864	.1/4"	1/32"-1/16"	27/64"	.040"	Natural	100
13865	.1/4"	1/32"-1/16"	27/64"	.040"	Black	100
13866	.5/16"	1/32"-9/64"	29/64"	.050"	Natural	100
13867	.5/16"	1/32"-9/64"	29/64"	.050"	Black	100
13868	.3/8"	1/32"-9/64"	37/64"	.050"	Natural	100
13869	.3/8"	1/32"-9/64"	37/64"	.050"	Black	100
13871	.7/16"	1/32"-11/64"	39/64"	.050"	Black	50
13872	.1/2"	1/32"-9/64"	43/64"	.062"	Natural	50
13873	.1/2"	1/32"-9/64"	43/64"	.062"	Black	50
13875	.9/16"	1/32"-9/64"	47/64"	.062"	Black	50
13876	.5/8"	1/32"-5/64"	51/64"	.062"	Natural	50
13877	.5/8"	1/32"-5/64"	51/64"	.062"	Black	50
13879	.11/16"	1/32"-7/64"	57/64"	.062"	Black	50
13880	.3/4"	1/32"-7/64"	63/64"	.062"	Natural	50
13881	.3/4"	1/32"-7/64"	63/64"	.062"	Black	50
13883	.13/16"	1/32"-7/64"	1-1/32"	.062"	Black	50
13885	.7/8"	1/32"-7/64"	1-5/64"	.062"	Black	50
13887	.1"	1/32"-7/64"	1-7/32"	.062"	Black	50



**Plastic Plug Buttons**

Black Polyethylene  
Depressed Center

Auveco Part No.	Hole Size	Head Dia.	Working Thickness	Unit Pkg.
9288	.1/2"	.7/8"	.02 - .07"	100
9289	.3/4"	1-5/32"	.02 - .14"	100
9290	.7/8"	1-1/4"	.02 - .10"	100
9291	.1"	1-3/8"	.04 - .10"	100
9292	1-1/4"	1-5/8"	.04 - .10"	100
9293	1-1/2"	1-7/8"	.04 - .10"	100
17207	1-3/4"	2-1/8"	.15 - .17"	50
17208	.2"	2-3/8"	.17 - .19"	50
18798	2-1/2"	.3"	.15 - .17"	25
18799	.3"	3-1/2"	.18 - .20"	10

**Flush Sheet Metal Plugs**

Black Polyethylene  
Fits 14 to 26 Gauge Material



Auveco Part No.	Hole Size	Head Dia.	Unit Pkg.
14923	.3/8"	.3/4"	100
11746	.1/2"	.7/8"	100
18750	.5/8"	1-3/64"	100
11747	.3/4"	.1"	100
11748	.7/8"	1-5/32"	100
11749	.1"	1-7/16"	100
18800	1-1/4"	1-5/8"	50
18801	1-1/2"	1-7/8"	25
18802	1-3/4"	2-1/8"	25
18803	.2"	2-7/16"	10
18804	2-1/2"	.3"	10
18806	.3"	3-3/8"	5



**Plug Buttons**

Nickel Plated

Auveco Part No.	Hole Size	Head Dia.	Working Thickness	Unit Pkg.
3750	.1/4"	13/32"	.035" - .062"	50
3751	.3/8"	.1/2"	.037" - .078"	50
3752	.1/2"	21/32"	.037" - .062"	50
3753	.5/8"	13/16"	.062" - .078"	50
3754	.3/4"	15/16"	.037" - .093"	50
3755	.7/8"	1-1/16"	.031" - .093"	50
3756	.1"	1-1/8"	.062" - .093"	50
10231	1-1/4"	1-7/16"	.062" - .093"	10
10232	1-1/2"	1-21/32"	.038" - .141"	10



**Display Boards Are Great**

**Selling Tools. Use Them To**

**Help Boost Your Sales.**

**Refer To The Color Pages**

**At The Front Of The Catalog.**

# Sec. 10

# Black Nylon Locking Hole Plugs



These hole plugs are designed with multiple locks to positively snap into panel thicknesses ranging from 1/64" to 1/8". Excellent for paintless dent repair. Made of heat stabilized nylon and suitable for elevated temperatures.

Auveco Part No.	Panel Hole Diameter	Maximum Panel Thickness	Plug Dimensions		Unit Pkg
			Head Diameter	Thickness	
19764	3/16"	1/16"	1/4"	15/64"	100
18900	1/4"	1/16"	5/16"	5/16"	50
19765	5/16"	1/16"	3/8"	5/16"	50
18901	3/8"	1/8"	15/32"	13/32"	50
19766	7/16"	1/8"	17/32"	13/32"	50
18902	1/2"	1/8"	37/64"	13/32"	50
19767	9/16"	1/8"	21/32"	13/32"	50
18903	5/8"	1/8"	23/32"	13/32"	50
19768	11/16"	1/8"	25/32"	13/32"	50
18904	3/4"	1/8"	59/64"	13/32"	50
19769	13/16"	1/8"	57/64"	13/32"	50
18905	7/8"	1/8"	1-1/64"	29/64"	50
18906	1"	1/8"	1-13/64"	29/64"	50
19770	1-1/32"	1/8"	1-7/32"	29/64"	50
19771	1/3/16"	1/8"	1-5/16"	29/64"	50
18907	1-1/4"	1/8"	1-3/8"	29/64"	50
19772	1-3/8"	1/8"	1-1/2"	29/64"	25
18908	1-1/2"	1/8"	1-43/64"	29/64"	25
18909	1-3/4"	1/8"	1-29/32"	29/64"	25
18910	2"	1/8"	2-9/64"	29/64"	25



**Straight Keys**  
Plain

Auveco Part No.	Size	Unit Pkg.
-----------------	------	-----------

**Short Lengths**

9792	3/16" x 3/16" x 3"	10
9793	3/16" x 3/16" x 4"	10
9759	1/4" x 1/4" x 2-1/2"	10
9774	5/16" x 5/16" x 4"	10

**Long Lengths**

9794	3/16" x 3/16" x 12"	5
9795	1/4" x 1/4" x 12"	5
9796	5/16" x 5/16" x 12"	5
9800	3/8" x 3/8" x 12"	5
9801	7/16" x 7/16" x 12"	5
9802	1/2" x 1/2" x 12"	5
9797	9/16" x 9/16" x 12"	5
9798	5/8" x 5/8" x 12"	5
9799	3/4" x 3/4" x 12"	5

## KEYS

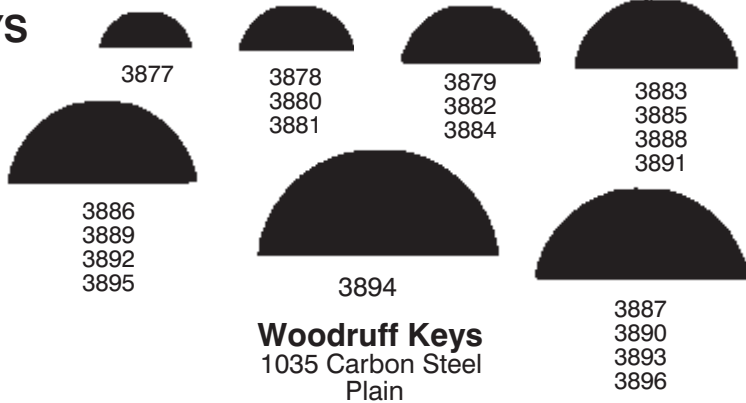

**Woodruff Keys**  
1035 Carbon Steel  
Plain

Auveco Part No.	Size	Unit Pkg.
-----------------	------	-----------

3877	(No. 3)	1/8" x 1/2"	100
3878	(No. 5)	1/8" x 5/8"	100
3879	(No. 7)	1/8" x 3/4"	100
3880	(No. 4)	3/32" x 5/8"	100
3881	(No. 6)	5/32" x 5/8"	100
3882	(No. 8)	5/32" x 3/4"	100
3883	(No. 10)	5/32" x 7/8"	100
3884	(No. 9)	3/16" x 3/4"	100
3885	(No. 11)	3/16" x 7/8"	100
3886	(No. 13)	3/16" x 1"	50
3887	(No. 16)	3/16" x 1-1/8"	50
3888	(No. 12)	7/32" x 7/8"	50
3889	(No. 14)	7/32" x 1"	50
3890	(No. 17)	7/32" x 1-1/8"	50
3891	(No. A)	1/4" x 7/8"	50
3892	(No. 15)	1/4" x 1"	50
3893	(No. 18)	1/4" x 1-1/8"	50
3894	(No. 21)	1/4" x 1-1/4"	50
3895	(No. B)	5/16" x 1"	50
3896	(No. C)	5/16" x 1-1/8"	50

For an Assortment of Woodruff Keys, see Kit No. 6065 and Large Drawer Assortment No. 6504 in the green pages.



# CAPS & CONNECTORS

## Vinyl Vacuum Caps

Can be used for capping lines and hoses while testing carburetors, emission control systems, vacuum lines etc. Color coded for size identification.

Auveco Part No.	I.D.	Fits Tube O.D.	Color	Length	Unit Pkg.
<b>18202</b>	1/8"	3/16"	Blue	5/8"	50
<b>18203</b>	3/16"	1/4"	Red	5/8"	50
<b>18204</b>	1/4"	5/16"	White	5/8"	50
<b>18205</b>	5/16"	3/8"	Black	5/8"	50

## Rubber Caps

(Special Heat Resistant EPDM Rubber)

Ford - GM - Chrysler



Can be used for capping lines and hoses while testing carburetors, emission control systems, vacuum lines, etc.



Auveco Part No.	Fits Tube O.D.	Inside Length	Unit Pkg.
<b>12209</b>	1/8"	9/16"	25
<b>4440</b>	3/16"	9/16"	25
<b>16264</b>			100
<b>19000</b>	3/16"	1-1/4"	25
<b>4439</b>	1/4"	9/16"	25
<b>19001</b>	1/4"	1-1/4"	25

Auveco Part No.	Fits Tube O.D.	Inside Length	Unit Pkg.
<b>19002</b>	5/16"	9/16"	25
<b>12907</b>	5/16"	1-1/4"	25
<b>12210</b>	3/8"	31/32"	25
<b>19003</b>	3/8"	1-1/2"	25
<b>12908</b>	1/2"	11/16"	10

## NYLON CONNECTORS



**12929**

Connector  
1/8" x 1/8"

UNIT PACKAGE: 10



**12936**

Connector  
1/8" x 1/4"

UNIT PACKAGE: 10



**12935**

Connector  
3/16" x 1/4"

UNIT PACKAGE: 10



**12930**

Connector  
1/8" x 3/16"

UNIT PACKAGE: 10



**12937**

Connector  
3/16" x 3/16"

UNIT PACKAGE: 10

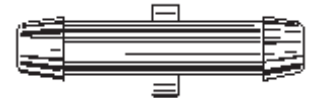

**12931**

Connector  
1/4" x 1/4"

UNIT PACKAGE: 10

**Sec. 11**

**NYLON CONNECTORS**

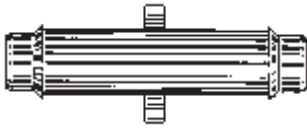

**12946**

Connector  
5/16" x 5/16"

UNIT PACKAGE: 10

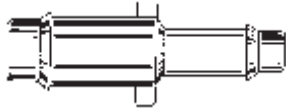

**12938**

Connector  
3/8" x 1/4"

UNIT PACKAGE: 10



**12934**

Connector  
3/8" x 3/8"

UNIT PACKAGE: 10

**18835**  
(E1ZE-9E499-EA)  
Nylon



Emission Harness  
Connector  
Ford

UNIT PACKAGE: 25

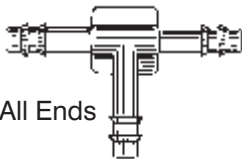

1/8" All Ends

**12923**

Tee

UNIT PACKAGE: 10

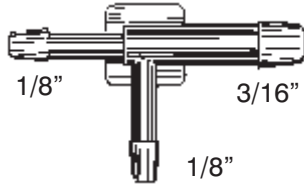

1/8" 3/16"

**12916**

Tee

UNIT PACKAGE: 10

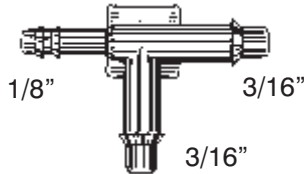

1/8" 3/16"

**12924**

Tee

UNIT PACKAGE: 10

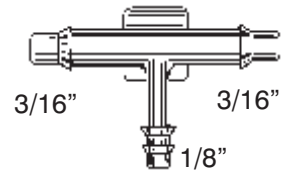

3/16" 3/16"

**12926**

Tee

UNIT PACKAGE: 10

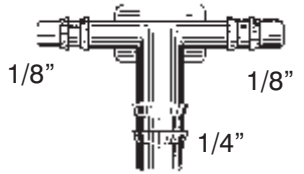

1/8" 1/8"

**12917**

Tee

UNIT PACKAGE: 10

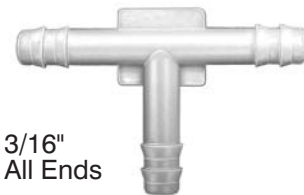

3/16"  
All Ends

**12918**

Tee

UNIT PACKAGE: 10

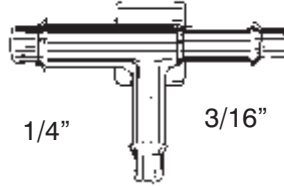

1/4" 3/16"

**12919**

Tee

UNIT PACKAGE: 10

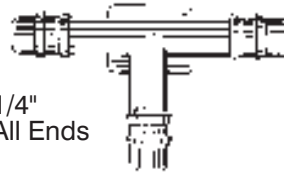

1/4"  
All Ends

**17629**

Tee

UNIT PACKAGE: 10

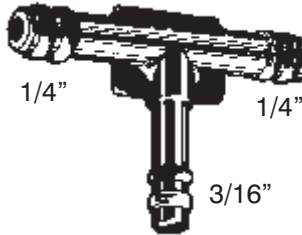

1/4" 1/4"

**11738**

Tee

UNIT PACKAGE: 10

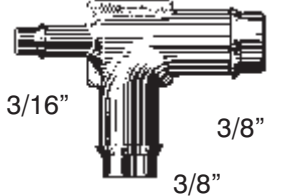

3/16" 3/8"

**12941**

Tee

UNIT PACKAGE: 10

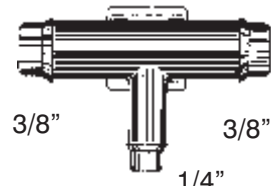

3/8" 3/8"

**12921**

Tee

UNIT PACKAGE: 10

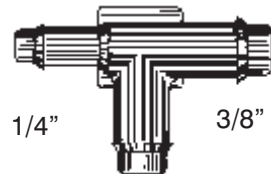

1/4" 3/8"

**12922**

Tee

UNIT PACKAGE: 10

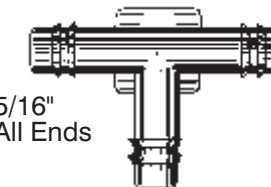

5/16"  
All Ends

**12920**

Tee

UNIT PACKAGE: 10

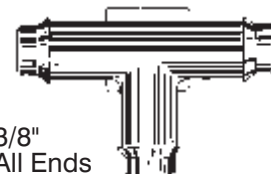

3/8"  
All Ends

**12925**

Tee

UNIT PACKAGE: 10

**NYLON CONNECTORS**

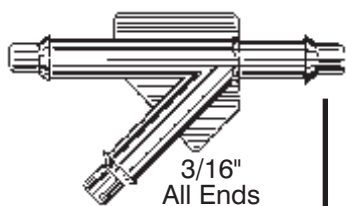

**12927**

Y Connector

UNIT PACKAGE: 10



**12945**

Y Connector

UNIT PACKAGE: 10

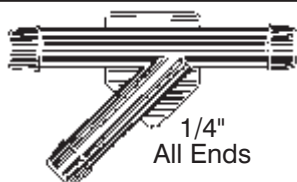

**12943**

Y Connector

UNIT PACKAGE: 10

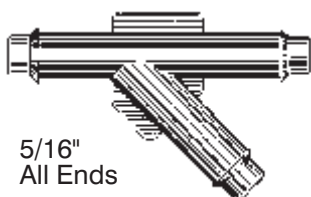

**12944**

Y Connector

UNIT PACKAGE: 10

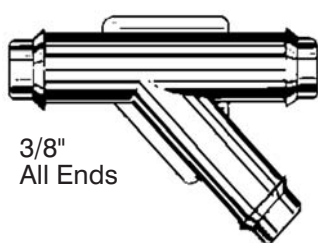

**12928**

Y Connector

UNIT PACKAGE: 5

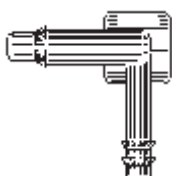

**12947**

Elbow  
1/8" x 3/16"

UNIT PACKAGE: 10

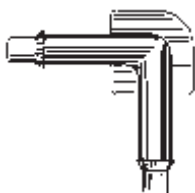

**12932**

Elbow  
3/16" x 3/16"

UNIT PACKAGE: 10

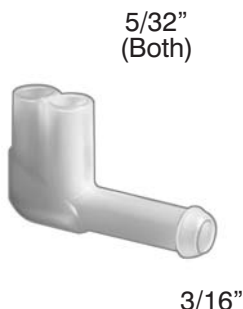

**18836**  
(E1ZE-9E499CA)

Emission Harness  
Elbow Connector  
Ford

UNIT PACKAGE: 25



**12948**

Elbow  
3/16" x 1/4"

UNIT PACKAGE: 10

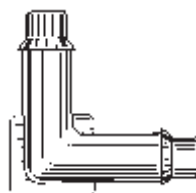

**12933**

Elbow  
1/4" x 1/4"

UNIT PACKAGE: 10

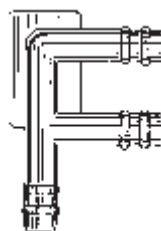

**12940**

F Connector  
3/16" All Ends

UNIT PACKAGE: 10

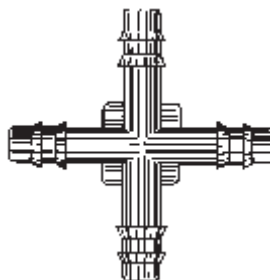

**12939**

Cross Connector  
3/16" All Ends

UNIT PACKAGE: 5

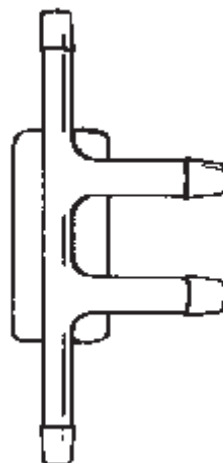

**11419**

4 Way Connector  
3/16" All Ends

UNIT PACKAGE: 25



**12949**

5 Way Tee  
3/16" All Ends

UNIT PACKAGE: 5

# Sec. 11

# NYLON CONNECTOR CROSS REFERENCE

## O.E.M. NUMBER CHART

Auveco Part No.	OEM No.	Auveco Part No.	OEM No.	Auveco Part No.	OEM No.
11419.....GM:	560692, 22508803	12925.....GM:	14023108	12935.....GM:	1621253, 472812
	Ford: 383847-S		Ford: 388131-S		Ford: 800843
11738.....GM:	3963228	12926.....GM:	14031114		AMC: 3239826
12916.....GM:	14025274, 14031144	12927.....GM:	10003617, 22508052	12936.....GM:	14017702
	Ford: 383016		Ford: 383031	12937.....GM:	560625, 22508051
	Chry: 4241362	12928.....GM:	14046514		Ford: 383003, 389138
12917.....GM:	1610403	12929.....GM:	14047034		Chry: 4104998
12918.....GM:	357020, 272766, 22508050		Ford: 383000	12938.....Ford:	E0VE-9K319AB
	Ford: 373846-S	12930.....GM:	14017701	12939.....GM:	354400
	Chry: 3671410		Ford: 383001		Ford: 387042
	AMC: 3673945		Chry: 3441743, 4241296	12940.....GM:	14029095
12919.....GM:	1617333, 10003294	12931.....GM:	1614858, 14004876, 10017487	12941.....GM:	14031149
	Ford: 388034		Ford: 383005	12943.....GM:	10004121
	GM: 6466355	12932.....GM:	556992, 14031145, 22508049		Chry: 4019472
	Chry: 4167810		Ford: 387065	12944.....Chry:	4179982
12921.....GM:	472814		Chry: 4100727	12945.....GM:	465994, 22511449
	Ford: D9AE-9E645AA		Ford: 387074	12946.....Chry:	4179981
12922.....GM:	472815	12933.....Ford:	387074	12947.....GM:	14017779
	Ford: 801471	12934.....GM:	22505958	12948.....Ford:	387980
12923.....GM:	14017705		Chry: 4201198	12949.....Ford:	384111
	Ford: 3895904				AMC: 3237451
	Chry: 3751212				
12924.....GM:	14017780				



### Hose Connectors Barbed On All Sides

Auveco Part No.	Hose Size	Unit Pkg.
10101*	1/8" x 1/8"	10
10102	3/16" x 3/16"	10
10103	1/4" x 1/4"	10
10104	5/16" x 5/16"	10
10105	3/8" x 3/8"	10
16961	1/2" x 1/2"	10

\*Single Barb On Each End



### Reducer Connectors Barbed On All Sides

Auveco Part No.	Hose Size	Unit Pkg.
10106	1/4" x 3/16"	10
10107	3/8" x 1/4"	10



### Tubing & Hose Tee Connectors Barbed On All Sides

Auveco Part No.	Hose Size I.D.	Unit Pkg.
10108	5/32" x 5/32" x 5/32"	10
10109	3/16" x 3/16" x 3/16"	10
10110	1/4" x 1/4" x 1/4"	10
14813	5/16" x 5/16" x 5/16"	10
11228	3/8" x 3/8" x 3/8"	10
11229	1/2" x 1/2" x 1/2"	10



**10697**

Tee Connector  
1/8" x 1/8" x 1/8"

UNIT PACKAGE: 10



# CONNECTORS

(ILLUSTRATIONS ACTUAL SIZE)

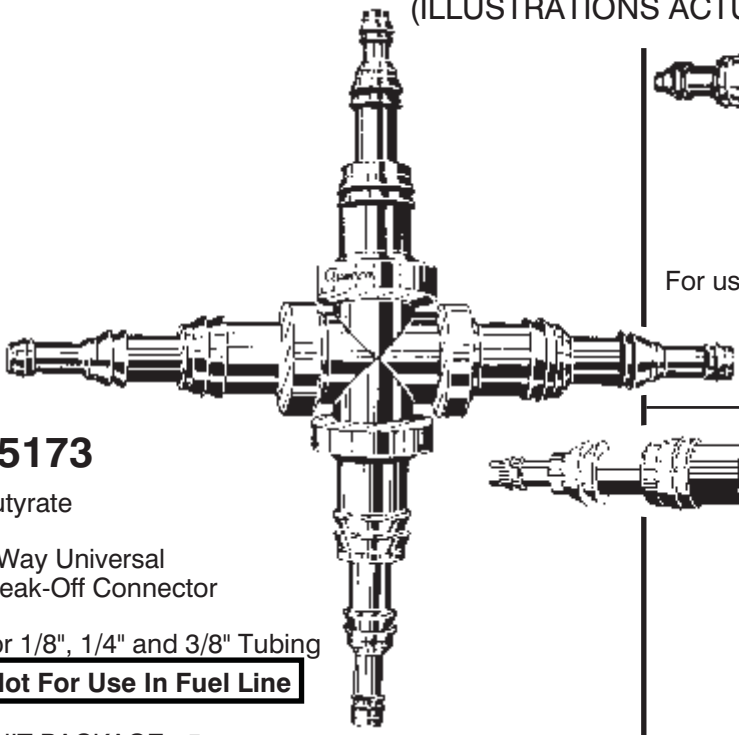

**15173**  
 Butyrate  
 4-Way Universal  
 Break-Off Connector  
 For 1/8", 1/4" and 3/8" Tubing  
**Not For Use In Fuel Line**  
 UNIT PACKAGE: 5



**11321**  
 Butyrate  
 For 1/8", 1/4" or 3/8"  
 Universal Tubing Connector  
 For use with Vacuum and Windshield Washer Tubing  
**Not For Use In Fuel Line**  
 UNIT PACKAGE: 10

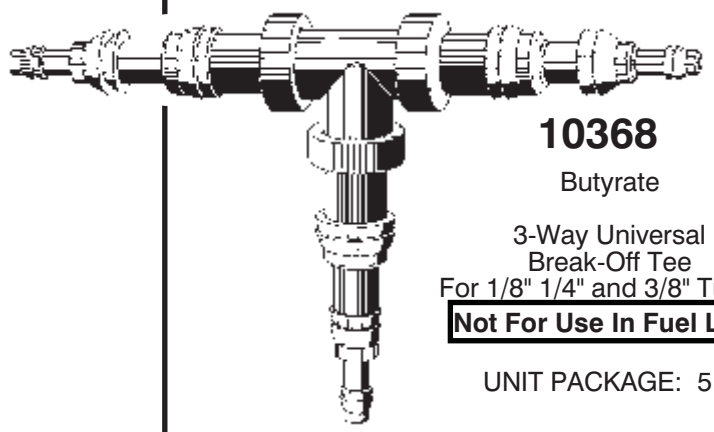

**10368**  
 Butyrate  
 3-Way Universal  
 Break-Off Tee  
 For 1/8" 1/4" and 3/8" Tubing  
**Not For Use In Fuel Line**  
 UNIT PACKAGE: 5

## RUBBER CONNECTORS

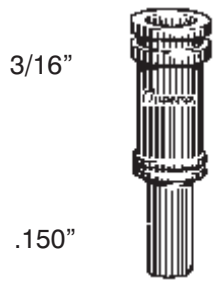

3/16"  
 .150"  
**16652**  
 Santoprene  
 Rubber  
 UNIT PACKAGE: 25



1/4"  
 .150"  
**18840**  
 (4179397)  
 Santoprene Rubber  
 GM  
 UNIT PACKAGE: 15

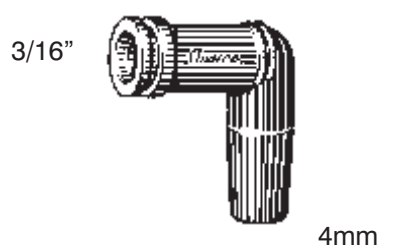

3/16"  
 4mm  
**16657**  
 Santoprene Rubber  
 UNIT PACKAGE: 25

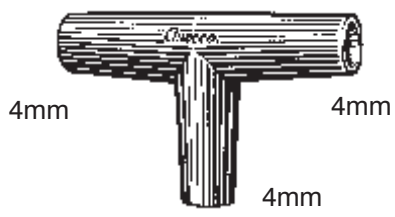

4mm  
 4mm  
 4mm  
**16654**  
 Santoprene Rubber  
 UNIT PACKAGE: 25



.150"  
 3/16"  
**16658**  
 EPDM Rubber  
 UNIT PACKAGE: 10

**CONNECTORS**



**High-Density Black Polyethylene  
Tubing & Hose Adapters**

**Non-Corrosive**

Auveco Part No.	Pipe Thread	Hose Size	Unit Pkg.
11209	1/8"	3/16" I.D.	10
11210	1/8"	1/4" I.D.	10
11211	1/4"	3/16" I.D.	10
11212	1/4"	1/4" I.D.	10
11213	1/4"	3/8" I.D.	10
11214	3/8"	3/8" I.D.	10
11215	3/8"	1/2" I.D.	10
11216	1/2"	1/2" I.D.	10

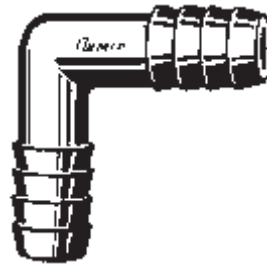

**High-Density Black Polyethylene  
Tubing & Hose Elbows**

**Non-Corrosive  
Barbed On Both Sides**

Auveco Part No.	Hose Size	Unit Pkg.
11224	3/8" x 3/8" I.D.	10
11225	1/2" x 1/2" I.D.	10



**High-Density Black Polyethylene  
Tubing & Hose Elbows**

**Non-Corrosive**

Auveco Part No.	Pipe Thread	Hose Size	Unit Pkg.
11217	1/8"	3/16" I.D.	10
11218	1/8"	1/4" I.D.	10
11219	1/4"	1/4" I.D.	10
11220	1/4"	3/8" I.D.	10
11221	3/8"	3/8" I.D.	10
11222	3/8"	1/2" I.D.	10

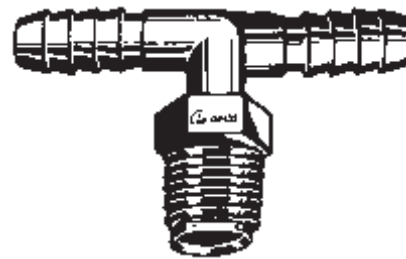

**High-Density Black Polyethylene  
Tubing & Hose Tee Connectors  
Non-Corrosive**

Auveco Part No.	Pipe Thread	Hose Size	Unit Pkg.
11226	1/4"	1/4" x 1/4" I.D.	10

**FasTrack**  
**Auveco's Cost Recovery System**  
**For Repair Fasteners....**  
**Never Lose Money On**  
**Fasteners Again!**

# AIR LINE COUPLINGS & ACCESSORIES

(Illustrations Are Not Actual Size)

**210 Series:** Push-to-connect, pin-type hose couplings designed for one-way shutoff in 1/4" capacity. **Average flow: 18 cfm** at 90 PSIG (6.2 bar) inlet and 10 PSIG (0.69 bar) pressure drop. Maximum inlet pressure: 250 PSIG (17 bar). Zinc chromate finish.



**16045**  
1/4" Female NPT  
UNIT PKG: 5



**16046**  
1/4" Male NPT  
UNIT PKG: 5



**16049**  
1/4" Female NPT  
UNIT PKG: 5



**16051**  
1/4" Male NPT  
UNIT PKG: 5



**16052**  
1/4" Hose Stem I.D.  
UNIT PKG: 5

**MS Series:** For use with industrial interchange style connectors. Push-to-connect type designed for one-way shutoff in 1/4" capacity. **Average flow: 36 cfm** at 90 PSIG (6.2 bar) inlet and 10 PSIG (0.69 bar) pressure drop. Maximum inlet pressure: 250 PSIG (17 bar). Zinc Chromate finish.



**16066**  
1/4" Female NPT  
UNIT PACKAGE: 5



**16067**  
1/4" Male NPT  
UNIT PACKAGE: 5



**16070**  
1/4" Female NPT  
UNIT PACKAGE: 5



**16071**  
1/8" Male NPT  
UNIT PACKAGE: 5



**16072**  
1/4" Male NPT  
UNIT PACKAGE: 5

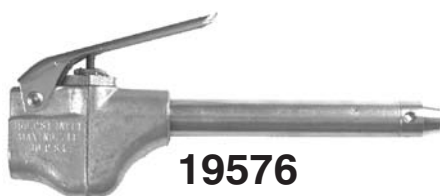

**19576**

Safety lever blow gun easily controls air flow making it ideal for hundreds of automotive and industrial uses in small or large industrial plants, service stations, garages, etc. Zinc alloy and brass construction.

Meets OSHA 150 PSI Inlet, Max. Nozzle 30 PSI SCFM 10.0 @ 100 PSI. 1/4" NPT air inlet.

UNIT PACKAGE: 1



**19578**

Siphon Spray Nozzle. Accessory For 19577 Blow Gun. For adding moisture or solvent to the air stream.

Unique dual thread design permits use on all blow guns with 7/16"-27 and 1/8" NPS threads. O-ring seal creates an air-tight assembly. Aluminum body construction.

UNIT PACKAGE: 1



**19577**

Compact safety lever blow gun. Includes a safety nozzle and a non-safety rubber tip nozzle. Features an easy to use hang-up hook. Chrome plated zinc alloy construction.

Meets OSHA 150 PSI Inlet, Max. Nozzle 30 PSI. Safety tip SCFM 11.7 @ 100 PSI. Non-safety tip 12.9 @ 100 PSI. 1/4" NPT air inlet

UNIT PACKAGE: 1



**19579**

Rubber Blow Gun Tip. Accessory For 19577 Blow Gun. For positive leak-proof connection when blowing out any fluids where a metal tip could mar the finish.

Unique dual thread design permits use on all blow guns with 7/16"-27 and 1/8" NPS threads. O-ring seal creates an air-tight assembly. Brass body construction.

UNIT PACKAGE: 2

# Sec. 11

## CLEAR FLEXIBLE VINYL (PVC) TUBING

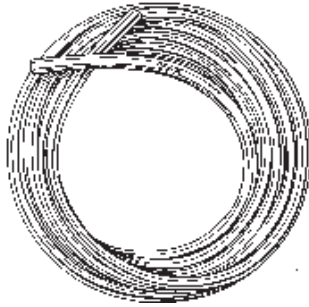

Our tubing has a broad range of chemical resistance to acids, alkalis and solvents. It's ideal for use in industrial air pressure line applications, in the food industry (FDA approved), for potable water, and for various gases and chemicals. Not for use with gasoline.

The Clear Flexible Tubing can be used with our connectors which are cataloged on pages 136. The tubing can also be installed with our Hose Clamps. Refer to the alphabetical index.

Auveco Part No.	I.D.	O.D.	Wall Thickness	*Maximum Suggested Working Pressure (PSI @ 70 F)	Unit Pkg.
14801	1/8"	1/4"	1/16"	59	100 Ft.
14802	3/16"	5/16"	1/16"	51	100 Ft.
14803	1/4"	3/8"	1/16"	51	100 Ft.
14804	5/16"	7/16"	1/16"	48	100 Ft.
14805	3/8"	1/2"	1/16"	41	100 Ft.
14806	3/8"	5/8"	1/8"	55	100 Ft.
14807	1/2"	5/8"	1/16"	28	100 Ft.
14808	1/2"	3/4"	1/8"	41	100 Ft.

\*We recommend verification by testing of the size and material to be used.

Female Brass Fitting

**Red Air Hose**

Male Brass Fitting

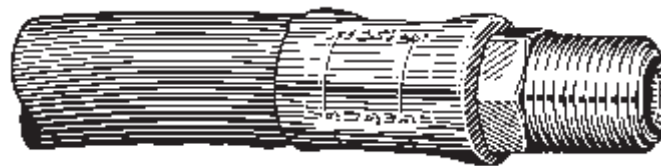

Four spiral reinforced EPDM rubber construction offers superior durability and excellent flexibility. Limited oil resistance. Coupled with brass fittings. Maximum working pressure is 300 P.S.I.

Auveco Part No.	I.D.	Description	Unit Pkg.
-----------------	------	-------------	-----------

Impact Tool Air Hose

15538	3/8"	1/4" Male Pipe Thread Fittings	25' Roll
15539	3/8"	1/4" Male Pipe Thread Fittings	50' Roll

### Black O.E.M. Heater Hose

Meets or exceeds SAE20R3 specifications. O.E.M. grade EPDM hose that withstands the abuse of corrosive additives, heat, cold, ozone, weather and abrasion



Auveco Part No.	I.D.	Unit Pkg.
15540	1/2"	50' Roll
15541	5/8"	50' Roll
15542	3/4"	50' Roll

# VACUUM & WINDSHIELD WASHER TUBING

# Sec. 11

For a Complete Listing of Barbed Brass Fittings See Page 233.

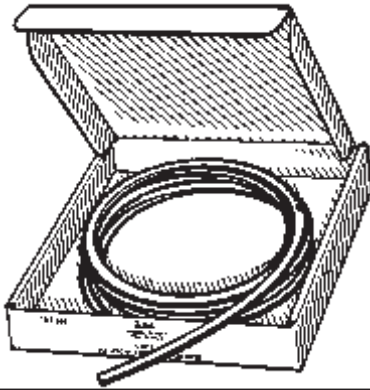

- Meets SAE J1037 Type 2 Specifications
- EPDM Rubber
- Packed in coils of 25 and 50 ft. lengths

Auveco Part No.	I.D.	O.D.		Unit Pkg.
4453	7/64"	9/32"	Fits 1/8" Nipple	25'
4454	7/64"	9/32"	Fits 1/8" Nipple	50'
4456	5/32"	5/16"	Fits 3/16" Nipple	25'
4457	5/32"	5/16"	Fits 3/16" Nipple	50'
4459	7/32"	13/32"	Fits 1/4" Nipple	25'
4460	7/32"	13/32"	Fits 1/4" Nipple	50'
4462	9/32"	15/32"	Fits 5/16" Nipple	25'
4463	9/32"	15/32"	Fits 5/16" Nipple	50'

## Fuel Line Hose

(Not For Electronic Fuel Injection)

For a Complete Listing of Barbed Brass Fittings See Page 233.

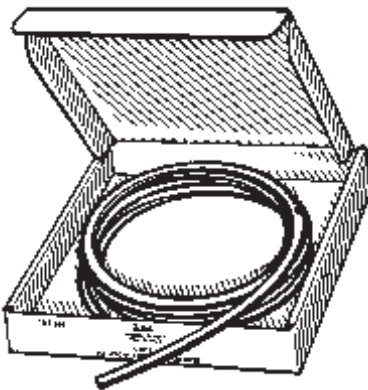

- Meets the following O.E.M. Specifications: (GM: 6165-M) (SAE J30R7) (Chrysler MSEA219)
- Packaged in coils of 25 and 50 ft. lengths
- Auveco Fuel Line Hose is of the highest quality and meets all O.E.M. specifications. It has a special chemical resistant interior, a single braid, and a neoprene exterior for maximum life and durability. For temperature range from -29°F to 257°F.
- Auveco Hose is designed for gas and diesel fuel lines (except Electronic Fuel Injection), emission control devices, and crankcase ventilation. In addition to the automotive applications, this hose is widely used on lawn mowers, marine motors, tractors and construction equipment to mention only a very few.

Auveco Part No.	Size	Working Pressure	Unit Pkg.
17085	3/16" I.D. x 13/32" O.D.	50 PSI	25'
4464	1/4" I.D. x 1/2" O.D.	50 PSI	25'
4465	1/4" I.D. x 1/2" O.D.	50 PSI	50'
4466	5/16" I.D. x 9/16" O.D.	50 PSI	25'
4467	5/16" I.D. x 9/16" O.D.	50 PSI	50'
4468	3/8" I.D. x 5/8" O.D.	35 PSI	25'

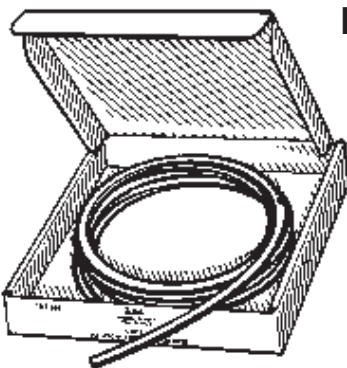

## Electronic Fuel Injection Hose

- Meets or exceeds SAE 30R9 specifications.
- Quality fluoroelastomer tube and CM cover handles virtually every fuel on the market.
- Burst strength exceeds 900 PSI.
- 180 PSI working pressure

Auveco Part No.	Size	Unit Pkg.	Use With Auveco Clamp No.
19271	1/4" I.D. x 1/2" O.D.	10 Ft.	15860
19272	5/16" I.D. x 9/16" O.D.	10 Ft.	15861
19273	3/8" I.D. x 5/8" O.D.	10 Ft.	15862

## Vacuum & Emission System Rigid Tubing

Black Hytrel Nylon • Used With Santoprene & EDPM Rubber Connectors  
Listed On Auveco Catalog Page 137.







Auveco Part No.	I.D.	O.D.	Unit Pkg.
19497	.120"	3/16"	10 Ft.

# Sec. 12

# SOLDERLESS TERMINALS

## Nylon Insulated - Our Finest



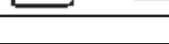



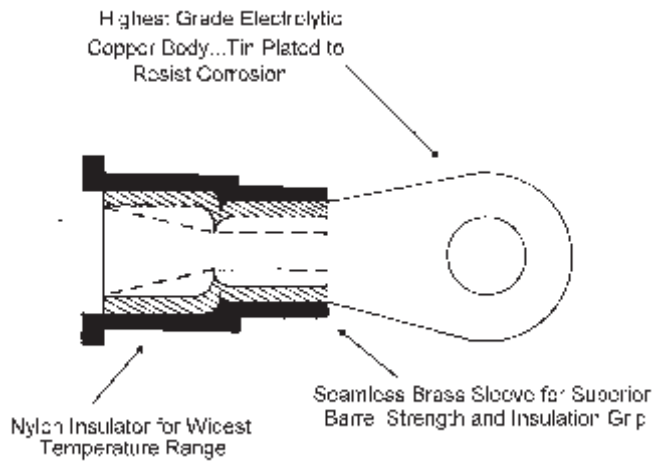



22-18 Gauge Wire Range (Red)

Actual Size	Stud Size	Auveco Part No.	Unit Pkg.
	#4 - #6	12149	25
	#8 - #10	12150	25
	#12 - 1/4"	17041	50
	#8 - #10	12163	25
	#4 - #6	12164	25
	Butt Connector	5791	50
		16487	1000

Nylon Insulated with Insulation Grip



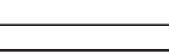



16-14 Gauge Wire Range (Blue)

Actual Size	Stud Size	Auveco No.	Unit Pkg.
	#4 - #6	9052	25
	#8 - #10	9055	25
	#12 - 1/4"	9056	25
	1/4" - 5/16"	9057	25
	5/16" - 3/8"	9058	25
	#4 - #6	9059	25
	#8 - #10	9060	25
	#8 - #10	9064	25
	Butt Connector	5792	50
		16488	1000
	1/4" Female Quick Connect	12148	25
	1/4" Male Quick Connect	12147	25

## Auveco's Finest

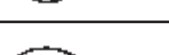
- \* Superior Vibration Resistance with Insulation Grip
- \* Superior Barrel Strength
- \* Constructed to Meet the Highest Military and Industrial Standards

12-10 Gauge Wire Range (Yellow)









Actual Size	Stud Size	Auveco No.	Unit Pkg.
	#8 - #10	12151	25
	#12 - 1/4"	12152	25
	5/16" - 3/8"	12153	25
	#8 - #10	12162	25
	Butt Connector	5793	50
		16489	500

# SOLDERLESS TERMINALS









For an assortment of Solderless Terminals see the Fix-Kits in the green pages.

## Vinyl Insulated - Copper - Electro Tin Plated

22-18 Gauge Wire Range (Red)

Actual Size	Stud Size	Auveco Part No.	Unit Pkg.
	#4 - #6	<b>5021</b>	100
	#8 - #10	<b>5023</b>	100
	#12 - 1/4"	<b>17040</b>	50
	#4 - #6	<b>5033</b>	100
	#8 - #10	<b>5034</b>	100
	#4 - #6	<b>5038</b>	100
	Butt Connector	<b>5047</b>	100
		<b>16484</b>	1000
	Closed End Butt Connector 22-14 Ga.	<b>9065</b>	100

16-14 Gauge Wire Range (Blue)

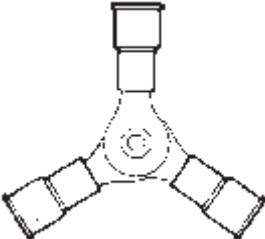
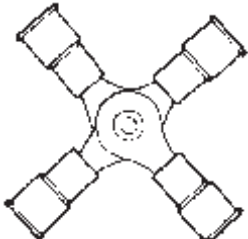
Actual Size	Stud Size	Auveco Part No.	Unit Pkg.
	#4 - #6	<b>5024</b>	100
	#8 - #10	<b>5026</b>	100
	#12 - 1/4"	<b>5027</b>	100
	5/16" - 3/8"	<b>12144</b>	25
	#4 - #6	<b>5035</b>	100
	#8 - #10	<b>5036</b>	100
	#8 - #10	<b>5040</b>	100
	Butt Connector	<b>5048</b>	100
		<b>16485</b>	1000
	Closed End Butt Connector 16-10 Ga.	<b>5072</b>	100
	3-Way Connector	<b>5055</b>	25
	4-Way Connector	<b>5057</b>	25

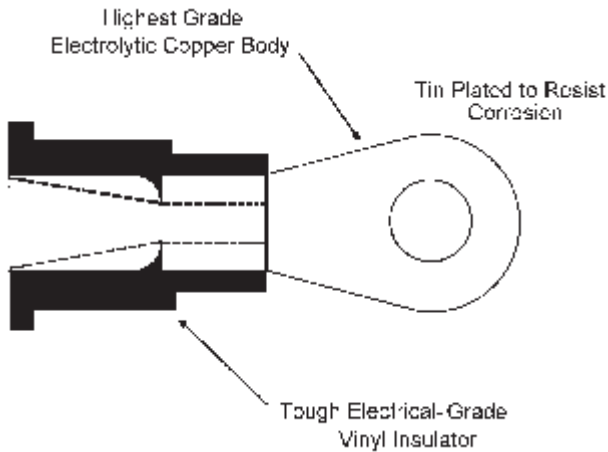

- \*Funnel Barrel for Easy Wire Insertion
- \*Friction Groove in Barrel Resists Wire Pullout
- \*Heat Treated for Maximum Strength







# Sec. 12



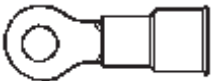
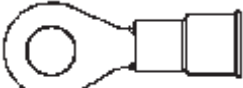

## SOLDERLESS TERMINALS

Vinyl Insulated - Copper - Electro Tin Plated

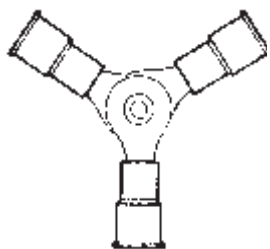
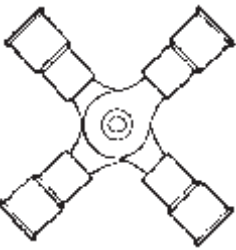

12-10 Gauge Wire Range (Yellow)

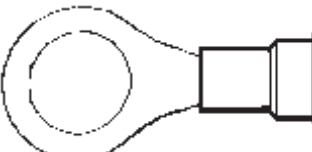
8 Gauge Wire Range (Red)

Actual Size	Stud Size	Auveco Part No.	Unit Pkg.
	#8 - #10	5028	100
	#12 - 1/4"	5029	100
	1/4" - 5/16"	5030	100
	5/16" - 3/8"	5031	100
	7/16" - 1/2"	5032	100
	#8 - #10	5037	100
	#8 - #10	5041	100
	Butt Connector	5049	100
		16486	500
	3-Way Connector	5056	25
	4-Way Connector	5058	25

Actual Size	Stud Size	Auveco Part No.	Unit Pkg.
	#12 - 1/4"	17042	25
	1/4" - 5/16"	17043	25
	5/16"-3/8"	17044	25
	7/16" - 1/2"	17045	15
	Butt Connector	17037	10

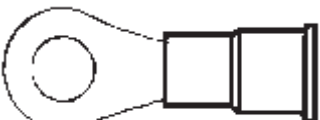
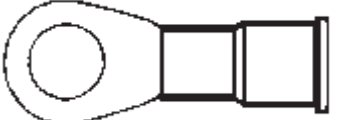
6 Gauge Wire Range (Blue)



Actual Size	Stud Size	Auveco Part No.	Unit Pkg.
	#12 - 1/4"	17046	15
	1/4" - 5/16"	17047	15
	5/16" - 3/8"	17048	15
	7/16" - 1/2"	17049	10
	Butt Connector	17038	10



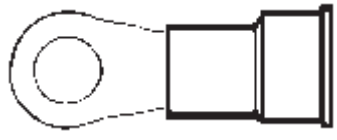

# SOLDERLESS TERMINALS

## Vinyl Insulated - Copper - Electro Tin Plated

4 Gauge Wire Range (Yellow)



Actual Size	Stud Size	Auveco Part No.	Unit Pkg.
	#12 - 1/4"	<b>17050</b>	10
	1/4"-5/16"	<b>17051</b>	10
	5/16"-3/8"	<b>17052</b>	10

4 Gauge Wire Range (Yellow)

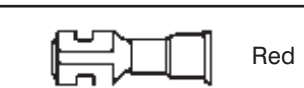

Actual Size	Stud Size	Auveco Part No.	Unit Pkg.
	7/16"-1/2"	<b>17053</b>	10
	Butt Connector	<b>17039</b>	10

### Quick-Connect Terminals

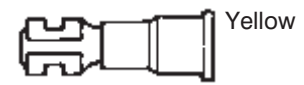



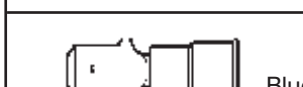

1/4" Female Terminals Vinyl Insulated

Actual Size	Wire Size	Auveco Part No.	Unit Pkg.
 Red	22-18 Ga.	<b>12155</b>	25
 Blue	16-14 Ga.	<b>5068</b>	100
 Yellow	12-10 Ga.	<b>12157</b>	25



1/4" Male Tabs - Vinyl Insulated

Actual Size	Wire Size	Auveco Part No.	Unit Pkg.
 Red	22-18 Ga.	<b>12154</b>	25
 Blue	16-14 Ga.	<b>5067</b>	100
 Yellow	12-10 Ga.	<b>12156</b>	25



Fully Insulated Nylon - Mating 1/4" Quick-Connects

 Red	22-18 Ga. Female	<b>11827</b>	50
 Red	22-18 Ga. Male	<b>11828</b>	50
 Blue	16-14 Ga. Female	<b>11606</b>	50
 Blue	16-14 Ga. Male	<b>11605</b>	50
 Yellow	12-10 Ga. Female	<b>11829</b>	25
 Yellow	12-10 Ga. Male	<b>11830</b>	25

.187 (3/16") Sizes - Vinyl Insulated

 Red	Male 22-18 Ga.	<b>17462</b>	25
 Red	Female 22-18 Ga.	<b>12159</b>	25
 Blue	Male 16-14 Ga.	<b>12165</b>	25
 Blue	Female 16-14 Ga.	<b>8781</b>	50

**1/4" Female Fully Insulated Nylon Piggyback Terminals**

Actual Size	Wire Range	Auveco Part No.	Unit Pkg.
	22-18 Ga. 1/4" Tab Std. Barrel (Red)	<b>19298</b>	15
	16-14 Ga. 1/4" Tab Std. Barrel (Blue)	<b>19299</b>	15
	12-10 Ga. 1/4" Tab Std. Barrel (Yellow)	<b>19300</b>	15

Actual Size	Wire Range	Auveco Part No.	Unit Pkg.
	16-14 Ga. 1/4" Tab Expanded Barrel For Two Wires (Blue)	<b>19302</b>	15

**Fully Insulated Tap-Disconnect**

	Wire Range	Auveco Part No.	Unit Pkg.
	22-18 Ga. (Red)	<b>12791</b>	10
	18-14 Ga. (Blue)	<b>12161</b> <b>14898</b> <b>14899</b>	10 100 500
	12 Ga. (Yellow)	<b>12792</b>	10
Mates with 11828, 11605 & 11830			

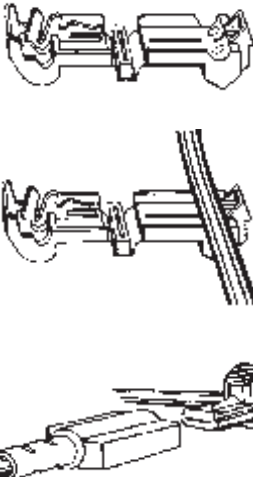

Fully insulated connector for tapping into a line without stripping the insulation. No special tools are required.

Place wire to be tapped in locating notch. Then close with pliers.

Complete connection with Auveco fully insulated male terminal:  
11828 (22-18 ga.),  
11605 (16-14 ga.) or  
11830 (12 ga.)

**Specialty Terminal - Vinyl Insulated**

	1/4" Tab 16-14 Ga.	<b>12158</b>	25
---	-----------------------	--------------	----

**Fuse Block Accessory Clip**

	For Add-on Electrical Equipment	<b>11405</b>	50
---	---------------------------------	--------------	----

**Blade Type Fuse Tap**

	For tapping "hot side" of fuse block	<b>14474</b>	25
Refer To Page 176.			

**Mini Fuse Blade Type Fuse Tap**

	For tapping "hot side" of mini fuse type fuse block	<b>17686</b>	50
Refer To Page 176.			

# SNAP PLUGS AND CONNECTORS

**Sec. 12**

Snap Plugs - 22-18 Ga.  
Universal - .157" Dia.

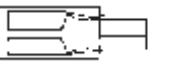

Snap Plugs - 22-18 Ga.  
Ford - .176" Dia.

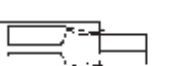
Actual Size	Description	Auveco Part No.	Unit Pkg.
 Red	Vinyl Insulated	<b>11604</b>	50
 Red	Insulated Crimp-on Female Mates with 11604	<b>10720</b>	10

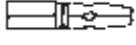

Actual Size	Description	Auveco Part No.	Unit Pkg.
 Red	Vinyl Insulated	<b>11603</b>	<b>50</b>
 Red	Insulated Crimp-On Female, Mates With 11603	<b>11601</b>	<b>25</b>

Snap Plugs 16-14 Ga.  
Universal (.157")

Snap Plugs 16-14 Ga.  
Ford (American & Lucas) (.176")

Actual Size	Description	Auveco Part No.	Unit Pkg.
	Non Insulated	<b>5060</b>	100
 Blue	Vinyl Insulated	<b>5063</b>	100
 Blue	Nylon Insulated	<b>12146</b>	25

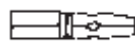
Use w/5073 & 10719 Connectors

Actual Size	Description	Auveco Part No.	Unit Pkg.
	Non Insulated	<b>5059</b>	100
 Blue	Vinyl Insulated	<b>5062</b>	100
 Blue	Nylon Insulated	<b>12145</b>	25

Use w/11600 & 11602 Connector

Universal Snap Plug Connectors (.157")

Ford Snap Plug Connectors (.176")

Actual Size	Description	Auveco Part No.	Unit Pkg.
 Clear	Vinyl Insulated 2 Way Use w/Universal Plugs	<b>5073</b>	50

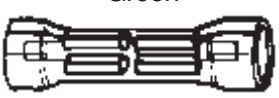
Actual Size	Description	Auveco Part No.	Unit Pkg.
 Green	Vinyl Insulated 2 Way Use w/Ford Snap Plugs	<b>11600</b>	50

Fully Insulated Crimp-On Female (.157")

Fully Insulated Crimp-on Female (.176")

Actual Size	Description	Auveco Part No.	Unit Pkg.
 Blue	Nylon 16-14 Ga. Mates with 5063 & 12146	<b>10719</b>	10
		<b>17494</b>	25

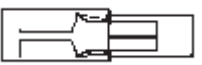
Actual Size	Description	Auveco Part No.	Unit Pkg.
 Blue	Nylon 16-14 Ga. Mates with 5062 & 12145	<b>11602</b>	25
		<b>17493</b>	50

Snap Plug Tap-Disconnect

Dual Male-Female Adaptor

Actual Size	Description	Auveco Part No.	Unit Pkg.
	18-14 Ga. Use Universal Snap Plugs (above)	<b>10319</b>	10

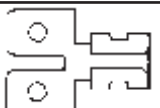
Actual Size	Description	Auveco Part No.	Unit Pkg.
	Converts .250" x .032" Male Tab to 2 Male Tabs	<b>8009</b>	100

Dual Male Female Adapter

1/4" Tab Inline Connector

Actual Size	Description	Auveco Part No.	Unit Pkg.
	Converts .250" x .032" Male Tab to 2 Male Tabs	<b>8788</b>	25







Actual Size	Description	Auveco Part No.	Unit Pkg.
		<b>5905</b>	50

# Sec. 12







# KRIMP & SEAL TERMINALS

Special polyolefin tubing when heated shrinks with a 3-1 ratio to completely seal entire connection, making penetration by any foreign material impossible.





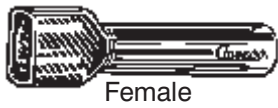

22-18 Gauge Wire Range (Red)

Actual Size	Stud Size	Auveco Part No.	Unit Pkg.
	#6	13656	10
	#10	13657	10
	Butt Connector	13659	10
		19258	25
 Female	.250"	13660	10
 Male	.250"	13661	10
	#10	13658	10





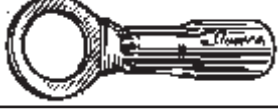

16-14 Gauge Wire Range (Blue) (Continued)

Actual Size	Stud Size	Auveco Part No.	Unit Pkg.
	Butt Conn.	13669	10
		19259	25
	.157"	13681	10
	.157"	13682	10
	.250"	13670	10
	.250"	13671	10
 Female	.250"	13672	10
		19260	25
 Male	.250"	13673	10
		19261	25

16-14 Gauge Wire Range (Blue)

Actual Size	Stud Size	Auveco Part No.	Unit Pkg.
	#6	13662	10
	#10	13663	10
	1/4"	13664	10
	5/16"	13665	10
	3/8"	13666	10
	#10	13667	10

12-10 Gauge Wire Range (Yellow)

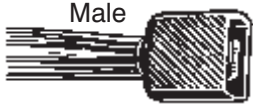
Actual Size	Stud Size	Auveco Part No.	Unit Pkg.
	#10	13674	10
	1/4"	13675	10
	3/8"	13676	10
	Butt Connector	13678	10
		19262	25
	#10	13677	10
 Female	.250"	13679	10
 Male	.250"	13680	10

**TERMINALS**

**Moisture Resistant Nylon Insulated Butt Connectors**

Protects electrical connections from corrosive environments - road chemicals, salt spray, etc. Insert wire and crimp twice (electrical and mechanical) at each end - no need for heat or chemicals.

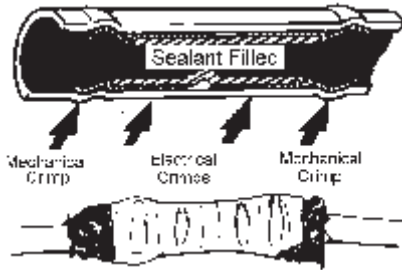

Auveco Part No.	Wire Range	Unit Pkg.
<b>13683</b>	22-18 Ga.	10
<b>13684</b>	16-14 Ga.	10
<b>13685</b>	12-10 Ga.	10

**Heat-Shrinkable, Solder-Type Closed-End Connectors And Terminals**

These terminators consist of a heat-shrinkable thermoplastic sleeve containing a spiral wound copper insert that is fitted with a prefluxed solder band. The unique combination of wire sizing and controlled soldering technology provides dependable electrical termination of as many as 10 wires of different sizes in a single connector.

Easy installation: Insert stripped wires into the terminator, then twist slightly. Twisting causes the copper insert to tightly grip, compress and hold the wires together. Apply heat. The tubing shrinks and the solder melts and flows through the copper insert into the center of the termination area, leaving the wires soldered together. The result is a reliable, insulated termination.



**Insulated Closed-End Connectors**

Auveco Part No.	Wire Range	Minimum Combination	Maximum Combination	Color Code	Unit Pkg.
<b>18712</b>	22-14 Ga.	2 22 Ga.	1 14 Ga. & 1 22 Ga.	Green	10
<b>18713</b>	18-14 Ga.	4 20 Ga.	1 14 Ga. & 2 18 Ga.	Red	10
<b>18715</b>	16-8 Ga.	1 10 Ga. & 1 12 Ga.	1 8 Ga. & 1 12 Ga.	Yellow	10



**Insulated & Sealed Closed-End Connectors**

Auveco Part No.	Wire Range	Minimum Combination	Maximum Combination	Color Code	Unit Pkg.
<b>18716</b>	22-14 Ga.	3 22 Ga.	1 14 Ga., & 1 22 Ga.	Green	10



**Insulated Ring Tongue Terminals**



Auveco Part No.	Wire Range	Stud Size	Minimum Combination	Maximum Combination	Unit Pkg.
<b>18720</b>	20-14 Ga.	#8	3 20 Ga.	1 14 Ga. & 1 18 Ga.	10
<b>18721</b>	20-14 Ga.	1/4"	3 20 Ga.	1 14 Ga. & 1 18 Ga.	10
<b>18722</b>	18-10 Ga.	1/4"	1 12 Ga.	3 16 Ga. & 3 18 Ga.	10
<b>18723</b>	18-10 Ga.	5/16"	1 12 Ga.	3 16 Ga. & 3 18 Ga.	10
<b>18724</b>	16-8 Ga.	1/4"	1 14 Ga. & 4 16 Ga.	1 8 Ga. & 2 16 Ga.	10
<b>18725</b>	16-8 Ga.	5/16"	1 14 Ga. & 4 16 Ga.	1 8 Ga. & 2 16 Ga.	10

# Sec. 12



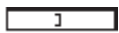

# SOLDERLESS TERMINALS

## Non-Insulated







### 22-18 Gauge Wire Range

Actual Size	Stud Size	Auveco Part No.	Unit Pkg.
	#4-#6	5000	100
	#8-#10	5002	100
	Butt Connector	5044	100



### 12-10 Gauge Wire Range

Actual Size	Stud Size	Auveco Part No.	Unit Pkg.
	#8-#10	5007	100
	#12-1/4"	5008	100
	5/16"	5009	100
	3/8"	5010	100
	Butt Connector	5046	100





### 16-14 Gauge Wire Range

	#4-#6	5003	100
	#8-#10	5005	100
	#12-1/4"	5006	100
	#4-#6	5014	100
	#8-#10	5015	100
	#8-#10 Flag Type	5043	100
	Butt Connector	5045	100

### Parallel Connectors (Fusible Link Connectors)

Actual Size	Wire Range	Auveco No.	Unit Pkg.
 Non-Insulated	16-14 Ga.	12630	100
 Non-Insulated	12-10 Ga.	12631	50

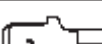
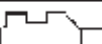

### 16-14 Gauge Wire Range - High Temperature

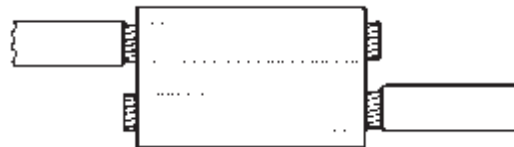
	#8-#10	17491	50
	#12-1/4"	17492	50
	.187" Female	10724	25
	.187" Male	10721	25
	1/4" Female	5066	100
	1/4" Male	17490	50



Parallel Connectors  
Proper Wire Insertion





### Splice Clips

Actual Size	Wire Range	Auveco Part No.	Unit Pkg.
	Max. of 3 #16 Ga.	18952	50
	Max. of 3 #12 Ga.	18953	50

# SOLDERLESS TERMINALS

## Non-Insulated

8 Gauge Wire Range

Actual Size	Stud Size	Auveco Part No.	Unit Pkg.
	1/4"	<b>15158</b>	25
	5/16"	<b>15159</b>	25
	3/8"	<b>15160</b>	25
	1/2"	<b>15161</b>	25



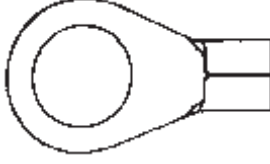

6 Gauge Wire Range (Continued)

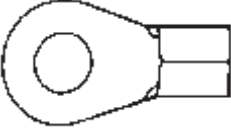
Actual Size	Stud Size	Auveco Part No.	Unit Pkg.
	3/8"	<b>15164</b>	25
	1/2"	<b>15165</b>	25

6 Gauge Wire Range

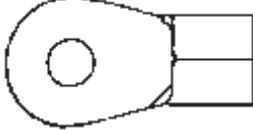
	1/4"	<b>15162</b>	25
	5/16"	<b>15163</b>	25

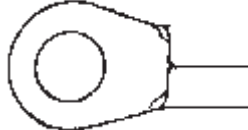
4 Gauge Wire Range

	1/4"	<b>15166</b>	10
	5/16"	<b>15167</b>	10
	3/8"	<b>15168</b>	10
	1/2"	<b>15169</b>	10

## Spark Plug Wire Terminals



Type 1



Type 2



Type 3

Auveco Part No.	Type	Description	Unit Pkg.
<b>5069</b>	1	7mm Coil and Distributor Cap Terminal	100
<b>5070</b>	2	7mm 90° Spark Plug Terminal	100
<b>5071</b>	3	7mm Straight Spark Plug Terminal	100

# Sec. 12

# SOLDERLESS TERMINALS



Make quick, reliable pre-insulated tap splices, in-line splices, pass-through connections and pigtail connections without stripping, twisting, soldering or using special tools.

Easy to use - Open the connector making sure the piercing barb is clear of the wire channels. Insert unstripped wires in the proper channels. Use pliers to squeeze down the piercing barb until the top is flush with the connector body. Close the hinged cover so it locks securely.

Auveco Part No.	Wire Size	Color	Unit Pkg.
17036	22-18 Ga.	Red	25
9481	18-14 Ga.	Blue	25
14896	18-14 Ga.	Blue	100
14897	18-14 Ga.	Blue	500

Tap connector with patented application system forces protective gel around the wire and element, providing a moisture-resistant barrier to destructive substances such as salt water and other corrosive environments. Withstands continuous operating temperatures of -40°C to 75°C (-40°F to 167°F).

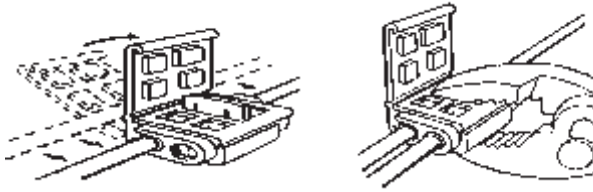

Auveco Part No.	Wire Size	Color	Unit Pkg.
17360	18-14 Ga.	Blue	50



## 10385

Tan

Heavy duty self-stripping connector designed for 14, 16, 18 gauge wire connected on to 10 or 12 gauge automotive wire. Ideal for over the road equipment where tap, in-line, and pigtail splices are required.

UNIT PACKAGE: 10



Fully insulated connector for tapping into a line without stripping the insulation. No special tools are required.

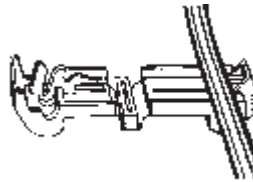

Place wire to be tapped in locating notch. Then close with pliers.

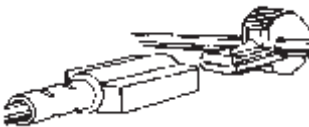

Complete connection with Auveco fully insulated male terminal:

- 11828 (22-18 ga.),
- 11605 (16-14 ga.) or
- 11830 (12 ga.)

Auveco Part No.	Wire Size	Color	Unit Pkg.
12791	22-18 Ga.	Red	10
12161	18-14 Ga.	Blue	10
14898	18-14 Ga.	Blue	100
14899	18-14 Ga.	Blue	500
12792	12 Ga.	Yellow	10

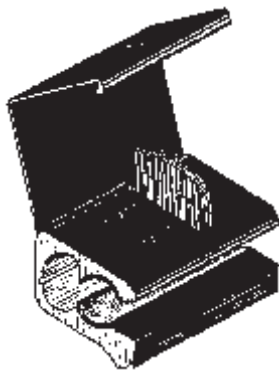

## 10386

Yellow

Designed exclusively for 10 or 12 gauge splicing on heavy duty vehicle wiring. Tap, in-line, and pigtail splices made quick and easy with this self-stripping connector.

UNIT PACKAGE: 10

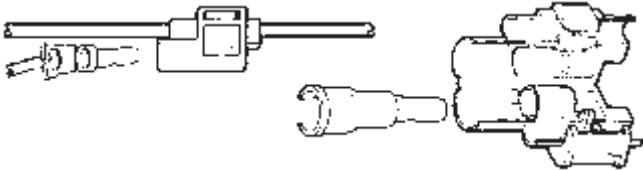

## 10319

Bullet receptacle connector for use with 18-14 gauge wire. Mates with Auveco snap plugs 5063 and 12146. Place wire to be tapped into connector channel, snap body together and lock into place with pliers.

UNIT PACKAGE: 10



## 14920 (with Sealant)

Self-stripping connector for making 2 or 3 wire pigtail connections with a wire range of 22-14 gauge. Simply insert 2 or 3 unstripped wires completely into the connector. Hold a crimping tool perpendicular to the wires and make the connection by driving the cap down. For use to 600V maximum.







UNIT PACKAGE: 10





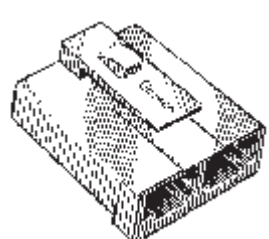





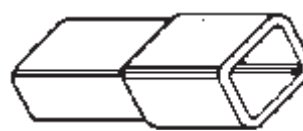





# O.E.M. TERMINALS & SHELLS



## GM 56 Series

**Sec. 12**

 <p><b>15957</b> (2965142) Tin Plated</p> <p>16-14 Ga. Insulated with shell 8777 Mates w/term. 15956 UNIT PACKAGE: 25</p>	 <p><b>8774</b> (2084421, 2962447) Unplated Brass</p> <p>16-14 Ga. Insulated with shell 8777 Mates w/term. 8776 UNIT PACKAGE: 50</p>	 <p><b>17001</b> (2962574; 2977615) Copper Alloy</p> <p>12 Ga. Insulated With Shell 8777 Mates w/Term. 17002 UNIT PACKAGE: 25</p>	 <p><b>12564</b> (6294493)</p> <p>Alternator Connector Shell Insulates 8774 terminals GM 1973-On UNIT PACKAGE: 10</p>
 <p><b>15956</b> (2971962) Tin Plated</p> <p>16-14 Ga. Insulated with shell 8775 Mates w/term. 15957 UNIT PACKAGE: 25</p>	 <p><b>8776</b> (2962987) Unplated Brass</p> <p>16-14 Ga. Insulated with 8775 Mates w/term. 8774 UNIT PACKAGE: 50</p>	 <p><b>17002</b> (8917283; 12015878) Tin Plated Copper</p> <p>12-10 Ga. Insulated with shell 8775 Mates w/term. 17001 UNIT PACKAGE: 25</p>	

 <p><b>8775</b> (2962984)</p> <p>Insulates 8776 and 15956 Mates with shell 8777 UNIT PACKAGE: 25</p>	 <p><b>8777</b> (2962448)</p> <p>Insulates 8774 and 15957 Mates with shell 8775. UNIT PACKAGE: 25</p>
---	---

<b>GM Weather Pack Series</b>			
 <p><b>14150</b> (12033674, 12089040) Tin Plated</p> <p>20-18 Ga. Mates with 14151. UNIT PACKAGE: 50</p>	 <p><b>15948</b> (12010085, 12089305) Tin Plated</p> <p>16-14 Ga. Mates with 15937 UNIT PACKAGE: 50</p>	 <p><b>18325</b> (12089306, 12124587) Tin Plated</p> <p>12 Ga. 20 Amp Max. Mates With 18324 UNIT PACKAGE: 25</p>	 <p><b>14152</b> (12015323) Green Silicone</p> <p>Cable seal Use w/14150, 14151, 15937 &amp; 15948 UNIT PACKAGE: 50</p>
 <p><b>14151</b> (12034051, 12089188) Tin Plated</p> <p>20-18 Ga. Mates with 14150 UNIT PACKAGE: 50</p>	 <p><b>15937</b> (12010182, 12124580) Tin Plated</p> <p>16-14 Ga. Mates with 15948 UNIT PACKAGE: 50</p>	 <p><b>18324</b> (12015917,12124581) Tin Plated</p> <p>12 Ga. 20 Amp. Max. Mates With 18325 UNIT PACKAGE: 25</p>	 <p><b>18326</b> (12010293) Gray Silicone</p> <p>Use With 14 Gauge GPT &amp; Cross-Link Polyethylene Primary Wire UNIT PACKAGE: 25</p>
 <p><b>14153</b> (12014836)</p> <p>20-18 Ga. Set of 14150 &amp; 14152 UNIT PKG: 25 Sets</p>	 <p><b>14154</b> (12014837)</p> <p>20-18 Ga, Set of 14151 and 14152 UNIT PKG: 25 Sets</p>	 <p><b>15955</b> (12010300) Silicone</p> <p>Cavity Plug Used to plug empty cavities in connector shell UNIT PACKAGE: 25</p>	 <p><b>20618</b> (12015193) Blue Silicone</p> <p>Use w/12 Gauge Auveco Terminals 18324 &amp; 18325 UNIT PACKAGE: 25</p>

 <p><b>15921</b></p> <p>20-18 Ga. Repair Lead 10" of 18 Ga. wire. UNIT PACKAGE: 5</p>	 <p><b>15922</b></p> <p>20-18 Ga. Repair Lead 10" of 18 Ga. wire. UNIT PACKAGE: 5</p>
--	---

**Sec. 12**

**O.E.M. SHELLS**



Not Actual Size  
**15949**  
(12010996)  
Nylon

Single cavity  
Mates w/15950  
UNIT PACKAGE: 25

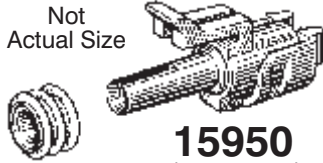

**15950**  
(12015791)  
Nylon

Single cavity  
Mates w/15949  
UNIT PACKAGE: 25

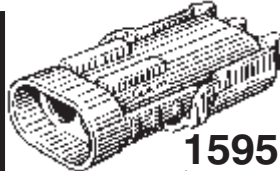

Not Actual Size  
**15951**  
(12010973)  
Nylon

Double cavity  
Mates w/15952  
UNIT PACKAGE: 25

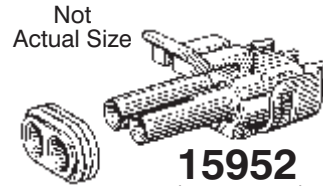

**15952**  
(12015792)  
Nylon

Double cavity  
Mates w/15951  
UNIT PACKAGE: 25

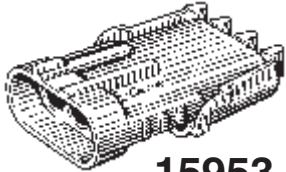

Not Actual Size  
**15953**  
(12010717)  
Nylon

Triple cavity  
Mates w/15954  
UNIT PACKAGE: 15

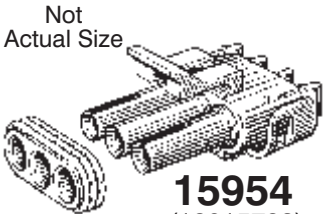

**15954**  
(12015793)  
Nylon

Triple cavity  
Mates w/15953  
UNIT PACKAGE: 15



Not Actual Size  
**18145**  
(12015797)  
Nylon

4 cavity flat tower  
Mates with 18146  
UNIT PACKAGE: 5

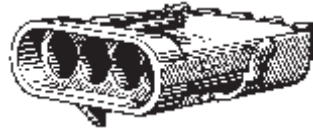

Not Actual Size  
**18146**  
(12010974)  
Nylon

4 cavity flat shroud  
Mates with 18145  
UNIT PACKAGE: 5

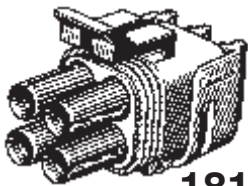

Not Actual Size  
**18147**  
(12015798)  
Nylon

4 cavity square tower  
Mates with 18148  
UNIT PACKAGE: 5

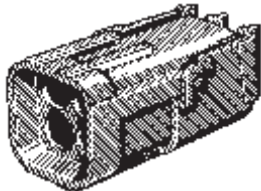

Not Actual Size  
**18148**  
(12015024)  
Nylon

4 cavity square shroud  
Mates with 18147  
UNIT PACKAGE: 5

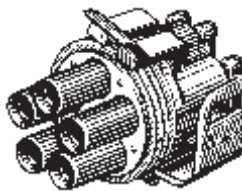

Not Actual Size  
**18149**  
(12034342)  
Nylon

5 cavity round tower  
Mates with 18150  
UNIT PACKAGE: 2

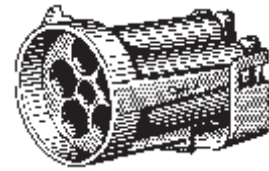

Not Actual Size  
**18150**  
(12065158)  
Nylon

5 cavity round shroud  
Mates with 18149  
UNIT PACKAGE: 5

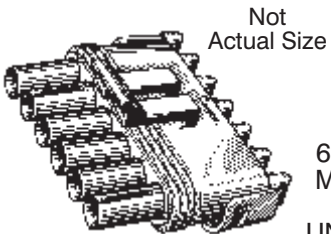

**18151**  
(12015799)  
Nylon

6 cavity flat tower  
Mates with 18152  
UNIT PACKAGE: 3



Not Actual Size  
**18152**  
(12010975)  
Nylon

6 cavity flat shroud  
Mates with 18151  
UNIT PACKAGE: 5

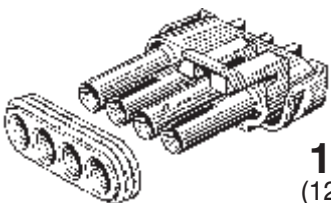

Not Actual Size  
**15923**  
(12015387)  
Nylon

Four cavity. For male terminal. Connects wiring harness to Idle Control Solenoid (ICS) Actuator on GM vehicles 1985-On

UNIT PACKAGE: 5

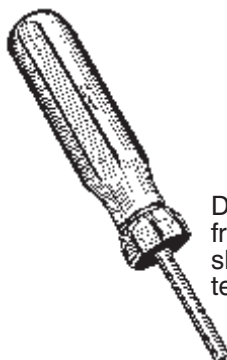

**14462**  
(12014012)

Weather Pack Terminal Extractor Tool  
Designed for extracting Weather Pack terminals from their connector housing. Slide the hollow shaft of the tool over the retention barbs of the terminal. Then pull the terminal out of its shell.

UNIT PACKAGE: 1

# O.E.M. TERMINALS

**Sec. 12**

## GM Electronic Control Module Terminal



**14882**  
(12034053,  
12004610)  
Tin Plated

20-18 Ga.

UNIT PACKAGE: 10

## GM Micro - Pack Terminals



**14883**  
(12020757)  
Tin Plated

20-18 Ga.

UNIT PACKAGE: 10



**15925**  
(12020758)  
Tin Plated

16-14 Ga.

UNIT PACKAGE: 50



**15924**  
(12040902)  
Tin Plated

22 Ga.

UNIT PACKAGE: 50

## GM Pack-Con I Series Terminals



**11948**  
(8900524,  
12020320)  
Tin Plated

16-14 Ga.  
Mates w/15935

UNIT PACKAGE: 25



**15936**  
(6294511)  
Tin Plated

20-18 Ga.  
Mates w/11947.

UNIT PACKAGE: 50



**15935**  
(12020347)

16-14 Ga.  
Mates w/11948

UNIT PACKAGE: 50



**18648**  
(8911640)  
Tin Plated

16-14 Ga.

UNIT PACKAGE: 25



**11947**  
(6294512,  
12020346)

20-18 Ga.  
Mates w/15936

UNIT PACKAGE: 25

## GM Pack-Con H.D. I Series Terminals



**15960**  
(12033817)  
Tin Plated

12-10 Ga.

UNIT PACKAGE: 25



**18649**  
(12033816)  
Tin Plated

16-14 Ga.

UNIT PACKAGE: 25



**15959**  
(8905087)  
Tin Plated

16-14 Ga.

UNIT PACKAGE: 25



**15958**  
(12004996)  
Tin Plated

16-14 Ga.

UNIT PKG: 25



**18650**  
(12020321)  
Brass

16-14 Ga.

UNIT PKG: 25

## GM Pack - Con II Series Terminals

## GM Pack Con III Series Terminals

## GM Metri-Pack 150 Series Terminals



**18653**  
(12045773)  
Tin Plated

20-18 Ga.

UNIT PKG: 25



**15498**  
(12047581)  
Tin Plated

20-18 Ga.  
Mates w/15497

UNIT PKG: 25



**15497**  
(12047680)  
Tin Plated

20-18 Ga.  
Mates w/15498

UNIT PKG: 25



**18654**  
(12048074)  
Tin Plated

20-18 Ga.

UNIT PKG: 25



**15499**  
(GM: 12047767;  
Chrys: 4368618)  
Tin Plated

20-16 Ga.

UNIT PKG: 25



**15500**  
(12052466)  
Tin Plated

24 Ga.

UNIT PKG: 25

## GM Metri-Pack 150 Series

## GM Metri-Pack 150.2 Pull To Seat

## GM Metri-Pack 150.1 Series Terminal



**20212**  
(12129484)  
Tin Plated

18 - 16 Ga.  
UNIT PKG: 15



**20213**  
(12129373)  
Tin Plated

22 - 20 Ga.  
UNIT PKG: 15



**20214**  
(12124075)  
Tin Plated

18 - 16 Ga.  
UNIT PKG: 15



**20215**  
(12124076)  
Tin Plated

22 - 20 Ga.  
UNIT PKG: 15



**16806**  
(12052922, 12089340)

20-18 Ga.  
Not For Use w/150.2 Series  
UNIT PACKAGE: 25

## GM 59 Series Terminal

## GM 59 Series Terminal

## GM Printed Circuit Board Terminal



**18690**  
(2973215)  
Tin Plated

Two 16-14 Ga. Leads  
Or One 12 Ga. Lead  
Fits 5/16" Male Tab

UNIT PACKAGE: 25



**18651**  
(2973216)  
Tin Plated

16-14 Ga.  
5/16" Blade Size

UNIT PACKAGE: 25















**20208**  
(12066272)  
Tin Plated

22 - 20 Ga.





UNIT PACKAGE: 10

# Sec. 12

## GM Metri-Pack 280 Series Terminals

 <b>18659</b> (12129497) Tin Plated  16-14 Ga.  UNIT PKG: 25	 <b>14880</b> (12020116) Tin Plated  18-14 Ga. Mates w/14881  UNIT PKG: 25	 <b>15946</b> (12034047) Tin Plated  20-18 Ga. Mates w/15947  UNIT PKG: 50	 <b>18658</b> (12129493) Tin Plated  16-14 Ga.  UNIT PKG: 25
 <b>14881</b> (12015857) Tin Plated  18-14 Ga. Mates w/14880  UNIT PKG: 25	 <b>15947</b> (12034046) Tin Plated  20-18 Ga. Mates w/15946  UNIT PKG: 50	 <b>18657</b> (12077411) Tin Plated  20-18 Ga.  UNIT PKG: 25	 <b>20216</b> (12015858) Tin Plated  12-10 Ga.  UNIT PKG: 15
 <b>20220</b> (12186456) Tin Plated  14 - 12 Ga. Mates w/20226  UNIT PKG: 15	 <b>20226</b> (12092344) Tin Plated  14 - 12 Ga. Mates w/20220  UNIT PKG: 15	 <b>20221</b> (12186457) Tin Plated  18 - 16 Ga. Mates w/ 20227  UNIT PKG: 15	 <b>20227</b> (12092345) Tin Plated  18 - 16 Ga. Mates w/ 20221  UNIT PKG: 15

## GM Metri-Pack 280 Series Tangless

 <b>20217</b> (12110842) Tin Plated  14-12 Ga. Used without cable seal  UNIT PKG: 15	 <b>20222</b> (12110845) Tin Plated  14 - 12 Ga. Used with cable seal  UNIT PKG: 15	 <b>20223</b> (12129409) Tin Plated  16 - 14 Ga. Used with cable seal  UNIT PKG: 15	 <b>20218</b> (12110844) Tin Plated  18 - 6 1Ga. Used without cable seal  UNIT PKG: 15	 <b>20224</b> (12110847) Tin Plated  18 - 16 Ga. Used with cable seal  UNIT PKG: 15
--	---	---	--	---

## GM Metri-Pack 280 Series Tangless

  
**20219**  
 (12110843)  
 Tin Plated  
  
 22 - 20 Ga.  
 Used without  
 Cable seal  
  
 UNIT PKG: 15

  
**20225**  
 (12110846)  
 Tin Plated  
  
 22 - 20 Ga.  
 Used with  
 Cable seal  
  
 UNIT PKG: 15

## GM Metri-Pack 280 Fuel Injector

  
**20230**  
 (12103360)  
 Tin Plated  
  
 22 - 20 Ga.  
  
 UNIT PKG: 15

## GM Metri-Pack 280 Series-Bus Bar

  
**20228**  
 (12110652)  
 Tin Plated  
  
 14 - 12 Ga.  
  
 UNIT PKG: 10

  
**20229**  
 (12110649)  
 Tin Plated  
  
 18 - 16 Ga.  
  
 UNIT PKG: 10

## GM Metri-Pak 480 Series

  
**15939**  
 (12020120)  
 Tin Plated  
  
 16-14 Ga.  
 3/16" Blade Width  
 Mates w/15938  
  
 UNIT PKG: 25

  
**15938**  
 (12015861)  
 Tin Plated  
  
 16-14 Ga.  
 Mates w/15939  
  
 UNIT PKG: 25

  
**18660**  
 (12048451)  
 Tin Plated  
  
 16-14 Ga.  
 For 3/16" Blade  
  
 UNIT PKG: 25

**GM Metri-Pack 630 Series**



**15944**

(12020126)  
Tin Plated  
16-14 Ga.  
1/4" Blade Width  
Mates w/15945

UNIT PKG: 50



**15945**

(12015870)  
Tin Plated  
16-14 Ga.  
Mates w/15944

UNIT PKG: 50

**GM Metri-Pack 630 Pull To Seat**



**20231**

(12066614)  
Tin Plated

16 - 14 Ga.

UNIT PKG: 15

**GM Micro-Pack 100 W Series Terminals**



**20209**

(12084912)  
Gold/Nickel Plated

18 Ga.  
Mates w/ 20211

UNIT PKG: 10



**20211**

(12160551)  
Gold/Nickel Plated

18 Ga.  
Mates w/ 20209

UNIT PKG: 10



**20210**

(12084913)  
Gold/Nickel Plated

22 - 20 Ga.

UNIT PKG: 10



**18655**

(12048247)  
Tin Plated

20-18 Ga.

UNIT PACKAGE: 25

**GM Power Window & Door Lock Terminals**



**15503**

(2965880)  
Tin Plated

16-14 Ga.

UNIT PACKAGE: 25

**Ford Wedgelock Pin Type Terminals**



**18411**

(E8EB-14461-AA)  
Tin Plated

16-14 Ga.  
.110" Dia. Pin  
Mates w/18412

UNIT PACKAGE: 25



**20475**

(E7EB-14461-BA)  
Tin Plated

20-18 Ga.  
.060" Dia. Pin  
Mates w/ 18408

UNIT PACKAGE: 25



**14887**

(D1AB-14461-AA)

20-18 Ga.  
.110" Dia. Pin  
Mates w/14888

UNIT PACKAGE: 25



**18412**

(E8EB-14488-UA)  
Tin Plated

16-14 Ga.  
.110" Dia. Pin  
Mates w/18411

UNIT PACKAGE: 25



**18408**

(E7EB-14487-AA)  
Tin Plated

20-18 Ga.  
.060" Dia. Pin  
Mates w/ 20475

UNIT PACKAGE: 25



**14888**

(D1AB-14488-CA)

20-18 Ga.  
.110 Dia. Pin  
Mates w/ 14887

UNIT PACKAGE: 25

**O.E.M. TERMINALS**  
**Ford Mini Block Terminals**



**16342**  
 (E7EB-14421-EA)  
 20-18 Ga.  
 1/8" Blade  
 Width  
 Mates  
 w/16344  
 UNIT PKG: 25



**16343**  
 (E8E8-14421-LA)  
 16-14 Ga.  
 For 1/8"  
 Blade  
 Mates w/  
 16345  
 UNIT PKG: 25



**16344**  
 (E7EB-14474-CA)  
 20-18 Ga.  
 For 1/8"  
 Blade  
 Mates  
 w/16342  
 UNIT PKG: 25



**16345**  
 (E8EB-14474-AJA)  
 16-14 Ga.  
 For 1/8"  
 Blade  
 Mates  
 w/16343  
 UNIT PKG: 25



**16346**  
 (E8EB-14474-AKA)  
 12-10 Ga.  
 For 1/8"  
 Blade  
 UNIT PKG: 25

**Ford Standard Box Terminals**



**16348**  
 (E8EB-14474-VA)  
 Tin Plated  
 16-14 Ga.  
 For 3/16" Blade  
 Mates w/16347  
 UNIT PACKAGE: 25



**14889**  
 (D8BB-14474-BA,  
 D3AB-14474-DA)  
 20-18 Ga.  
 UNIT PACKAGE: 25

**Ford Micro Female Terminal**



**16805**  
 (E8EB-14474-AMA)  
 16-14 Ga.  
 Fits 1/8" Wide Tab  
 UNIT PACKAGE: 25

**Ford Miniature Pin Type Terminals**



**18852**  
 (E3VB-14488-AA)  
 20-18 Ga.  
 .062" Dia. Pin  
 Mates With 18853  
 Ref. B-8  
 UNIT PACKAGE: 25



**18853**  
 (E3VB-14461-AA)  
 20-18 Ga.  
 .062" Dia. Pin  
 Mates With 18852  
 Ref. A-9  
 UNIT PACKAGE: 25

**Ford Mark I Terminal**



**18854**  
 (E27B-14474-BA)  
 20-14 Ga.  
 Female  
 Ref. D-20  
 UNIT PACKAGE: 15

**Chrysler Terminals**



**16801**  
 (7368261)  
 20-18 Ga.  
 3/32" Dia. Pin; Male  
 Mates w/16802  
 UNIT PACKAGE: 25



**16802**  
 (4368163)  
 20-18 Ga.  
 3/32" Dia. Pin; Female  
 Mates w/16801  
 UNIT PACKAGE: 25



**16803**  
 (4368960)  
 20-18 Ga.  
 1/16" Dia. Pin; Female  
 Fits 60 pin connection  
 block on engine  
 compartment fire wall  
 UNIT PACKAGE: 25



**16804**  
 (4304729)  
 24-18 Ga.  
 Double Cantilever  
 Spring Terminal  
 Used with P.C. board  
 connections & general  
 purpose  
 UNIT PACKAGE: 25

**Chrysler Quick Connect Electrical Terminals**



**14893**  
 (3843386)  
 20-18 Ga.  
 1/4" Blade Width  
 Mates w/14894  
 UNIT PACKAGE: 25



**14894**  
 (3843601)  
 Tin Plated Brass  
 20-18 Ga.  
 For 1/4" Blade  
 Mates w/14893  
 UNIT PACKAGE: 25



**16349**  
 (3843386)  
 16-14 Ga.  
 1/4" Blade  
 Width  
 Mates w/16350  
 UNIT PACKAGE: 25



**16350**  
 (3843601)  
 Tin Plated Brass  
 16-14 Ga.  
 For 1/4" Blade  
 Mates w/16349  
 UNIT PACKAGE: 25

**Chrysler P.C. Terminal**



**18414**  
 (3764556)  
 Brass  
 20-18 Ga.  
 UNIT PACKAGE: 25

# Universal Terminals

**Sec. 12**



**14892**  
(GM: 2965470;  
Ford: C5AB-14474-B;  
Chrys: 2096466)  
Brass

20-18 Ga.  
1/4" Female

UNIT PACKAGE: 25



**15504**  
(GM: 2965580;  
Ford: C1SF-14474-A;  
Chrys: 2096467)  
Unplated

14-12 Ga.  
1/4" Female

UNIT PACKAGE: 25



**17115**  
(GM: 2962953;  
Ford: C2TB-14462A;  
Chry: 2096454)  
Bare Copper

12-10 Ga.  
3/8" (10mm) Stud  
Size

UNIT PACKAGE: 25



**18450**  
(GM: 12004475)  
Tin Plated

12-10 Ga.  
3/8" Stud Size  
Locking Type

UNIT PACKAGE: 25



**17116**  
(GM: 2984375;  
Ford:  
C8AB-14463-D;  
Chry: 2889061)  
Tin Plated

16-14 Ga.  
#10 Stud Size  
Locking Type

UNIT PKG: 25



**17117**  
(GM: 2984626;  
Ford:  
C8AB-14463N;  
Chry: 4274166)  
Tin Plated

16-14 Ga.  
1/4" (6.3mm) Stud  
Size  
Locking Type

UNIT PKG: 25



**18451**  
(GM: 8917225;  
Ford: C8AB-14463-M)

16-14 Ga.  
5/16" Stud Size  
Locking Type

UNIT PACKAGE: 25

## Mate-N-Lock Terminals

Commonly used in cellular phone and communication equipment installations, office machines and machine controls.



**18855**  
20-14 Ga.  
.084" Dia. Pin  
Single Retention Barb  
Mates With 18856

UNIT PACKAGE: 25



**18856**  
20-14 Ga.  
.084" Dia. Pin  
Single Retention Barb  
Mates With 18855

UNIT PACKAGE: 25



**18857**  
20-14 Ga.  
.084" Dia. Pin  
Dual Retention Barbs  
Mates With 18858

UNIT PACKAGE: 25



**18858**  
20-14 Ga.  
.084" Dia. Pin  
Dual Retention Barbs  
Mates With 18857

UNIT PACKAGE: 25

**Visit the Auveco web site at [www.auveco.com](http://www.auveco.com)  
for the information on new items.**

**Terminal Extractor Picks**

Used to release most GM, Ford and Chrysler OEM terminals from their insulating shells. Not suitable for round, pin-type terminals.

**14884**

(12012000)

Narrow Blade (.050")

UNIT PACKAGE: 1

**14885**

(8913369)

Wide Blade (.090")

UNIT PACKAGE: 1

**20583**

(12094429)

Micro Terminal Extractor Pick  
.035" Wide Blade Used to release 150 Metri-Pack, 280 Metri-Pack, 280 Tangless, 280 Bus Bar, 630 Pull to Seat, GT 150, GT 280, Wedge Base Light Socket terminals and indexing Candelabra Bayonet Double Contact Light Socket terminals.

UNIT PACKAGE: 1

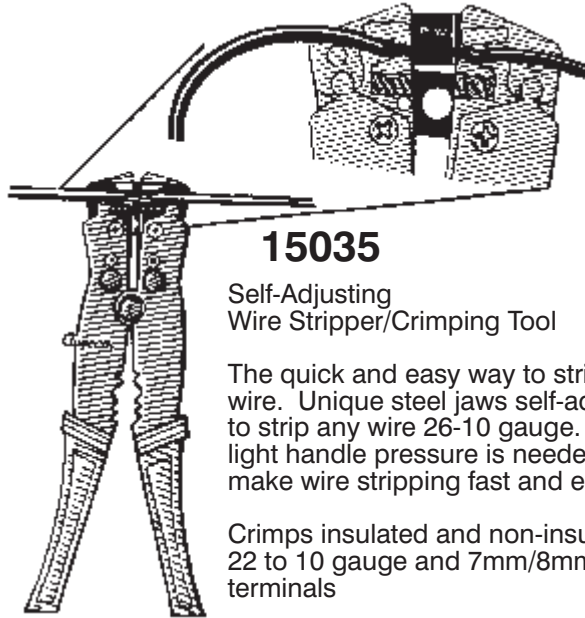

**15035**

Self-Adjusting Wire Stripper/Crimping Tool

The quick and easy way to strip wire. Unique steel jaws self-adjust to strip any wire 26-10 gauge. Only light handle pressure is needed to make wire stripping fast and easy.

Crimps insulated and non-insulated 22 to 10 gauge and 7mm/8mm terminals

Also features precision machined blade for cutting wire sharp and smooth. Overall Length: 8-1/4"

UNIT PACKAGE: 1

**Open Barrel Terminal Crimping Tool**  
For O.E.M. Terminals

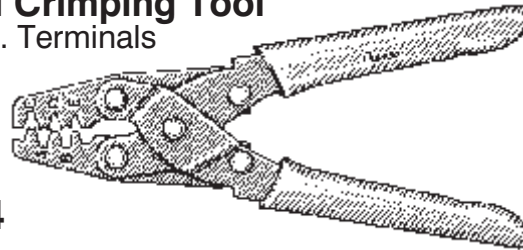

**16004**

Duplicates factory crimps on open barrel terminals used in automotive, computer and control applications. Features five machined and hardened crimp stations for 14 to 24 gauge wire terminations. Parallel jaws eliminate faulty crimps. Overall Length: 8-1/2"

UNIT PACKAGE: 1

Insulation Crimp	}	For Wire Range	Use Crimp Station	Stripped Wire Crimp	}	For Wire Range	Use Crimp Station
		14-18 Ga.	A			14-16 Ga.	C
		20-24 Ga.	B			18-20 Ga.	D
						22-24 Ga.	E

**7711**

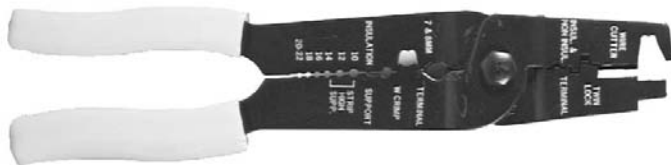

Cuts and strips 22-8 gauge wire. Crimps insulated and non-insulated solderless terminals in sizes from 22-10 gauge. Overall Length: 9"

UNIT PACKAGE: 1



**CONNECTORS**

**Push Type Wire Connectors**

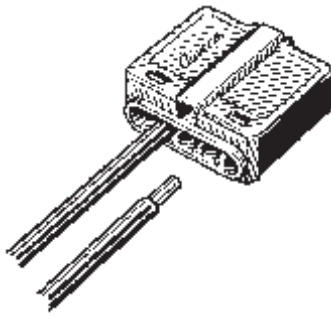

New type connectors that let you push wires into contact for a positive copper-to-copper connection without twisting or taping. Test holes in the front and back of the connectors accept round or flat probes of test equipment to facilitate troubleshooting.

Auveco Part No.	No. of Wires	Gauge	Rated Voltage	Color	Unit Pkg.
<b>15845</b>	3	22-16	300	Gray	25
<b>15849</b>	4	18-12	600	Blue	25

**Wire Nut® Connectors**



**10378** UNIT PACKAGE: 25  
**15204** UNIT PACKAGE: 100  
 Gray

Joins 18 & 16 Ga. Wires  
 Minimum of 2 #18 Ga. Wires  
 Maximum of 2 #16 Ga. Wires

**10379** UNIT PACKAGE: 25  
**15205** UNIT PACKAGE: 100  
 Blue

Joins 18-14 Ga. Wires  
 Minimum of 2 #18 Ga. Wires  
 Maximum of 3 #16 Ga. Wires

**10380** UNIT PACKAGE: 25  
**15206** UNIT PACKAGE: 100  
 Orange

Joins 18-14 Ga. Wires  
 Minimum of 2 #18 Ga. Wires  
 Max. of 3 #16 Ga & 1 #18 Ga. Wires

**10381** UNIT PACKAGE: 25  
**15207** UNIT PACKAGE: 100  
 Yellow

Joins 18-12 Ga. Wires  
 Min. of 1 #14 Ga. & 1 #18 Ga. Wires  
 Max. of 2 #14 Ga. & 3 #16 Ga. Wires

**10382** UNIT PACKAGE: 25  
**15208** UNIT PACKAGE: 100  
 Red

Joins 18-10 Ga. Wires  
 Min. of 1 #12 Ga. & 2 #18 Ga. Wires  
 Max. of 2 #10 Ga. & 1 #12 Ga. Wires

**Wing Wire Nut® Connectors**

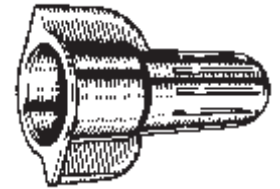

**10384** UNIT PACKAGE: 25  
**15209** UNIT PACKAGE: 50  
 Blue

Joins 14-6 Ga. Wires  
 Minimum of 1 #10 Ga. &  
 1 #12 Ga. Wires  
 Max. of 1 #6 Ga. & 2 #8 Ga.

**15705**  
 Yellow  
 Joins 22-12 Ga. Wires  
 Minimum of 2 #18 Ga. Wires  
 Maximum of 2 #12 Ga. Wires

UNIT PACKAGE: 50

**15706**  
 Red

Joins 20-8 Ga. Wires  
 Min. of 2 #16 Ga. Wires  
 Max. of 4 #12 Ga. Wires

UNIT PACKAGE: 50

**Wing Wire Connectors**

Combines both the wide range and torque of wing-style connectors with a new flexible skirt that provides over-strip protection without taking additional space in the electrical box.

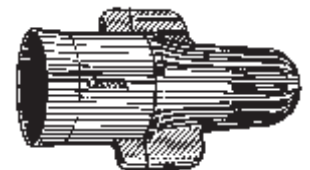

**18312**  
 Orange & Blue  
 Joins from two 22 ga.  
 to two 12 ga. wires  
 UNIT PACKAGE: 25

**Circuit Tester**

For Troubleshooting DC Primary Circuits On 6 & 12 Volt Vehicles

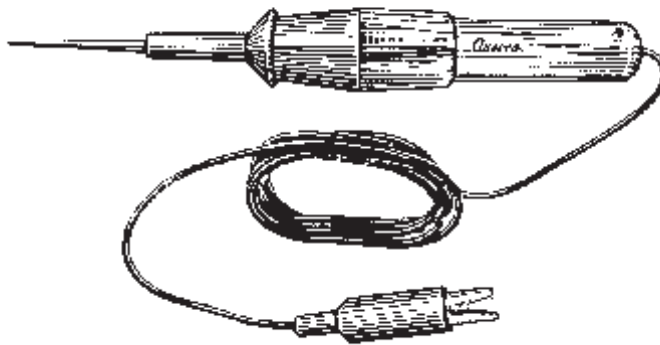

**16420**

UNIT PACKAGE: 1

**Use to Check:**

- Lighting Systems
- Wipers
- Horn
- Electric Clock,
- Windows, Locks
- Fuses
- Relays

**Features:**

- 4 Feet of Wire
- Mechanical Strain Relief
- Impact & Chemical Resistant Housing
- 8" Long Probe/Housing
- Super Sharp Probe, Tempered To Last
- 2" Long Alligator Clip

**Wire Loom**

(Split Flexible Tubing)

Can withstand Maximum Temperature of 345°F



I.D. 1/4" - O.D. 3/8"  
Nylon 6 - Black

**14197** 10' Length  
**14201** 50' Length (Bulk)



I.D. 3/8" - O.D. 9/16"  
Nylon 6 - Black

**14198** 10' Length  
**14202** 50' Length (Bulk)



I.D. 1/2" - O.D. 11/16"  
Nylon 6 - Black

**14199** 10' Length  
**14203** 50' Length (Bulk)



I.D. 5/8" - O.D. 13/16"  
Nylon 6 - Black

**20536** 50' Length



I.D. 3/4" - O.D. 15/16"  
Nylon 6 - Black

**14200** 10' Length  
**14204** 50' Length (Bulk)



I.D. 1" - O.D. 1-1/8"  
Nylon 6- Black

**18194** 25' Length

# PRIMARY WIRE

## General Purpose



Standard PVC Insulation (SE/GPT Type)  
 Suitable for Most Automotive Applications  
 Free Stripping, Abrasion Resistant  
 Meets Most O.E.M. Vehicle Standards

UNIT PACKAGE: 1 Roll



The lower the gauge number, the thicker the wire (i.e. 10 gauge is thicker than 16 gauge)

Gauge	Stranding	O.D.	Auveco Part No				
			Red	White	Black	Blue	Length
18	16 x 30	.092	. . . .	. . . .	<b>20488</b>	<b>20489</b>	45 Ft.
16	19 x 29	.104	<b>20490</b>	<b>20491</b>	<b>20492</b>	<b>20493</b>	35 Ft.
12	19 x 25	.142	<b>20494</b>	<b>20495</b>	<b>20496</b>	<b>20497</b>	15 Ft.
10	19 x 23	.175	. . . .	<b>20499</b>	. . . .	<b>20501</b>	10 Ft.

### 25 Foot Spool

Gauge	Stranding	O.D.	Auveco Part No					
			Red	White	Black	Blue	Green	Yellow
18	16 x 30	.092	<b>12411</b>	<b>12412</b>	. . . .	. . . .	. . . .	<b>15234</b>
16	19 x 29	.104	. . . .	. . . .	<b>12417</b>	. . . .	. . . .	. . . .
14	19 x 27	.117	<b>12419</b>	<b>12420</b>	<b>12421</b>	<b>12422</b>	<b>15239</b>	<b>15240</b>
12	19 x 25	.142	. . . .	. . . .	. . . .	. . . .	. . . .	. . . .
10	19 x 23	.175	<b>15249</b>	. . . .	<b>15251</b>	. . . .	. . . .	. . . .

### 100 Foot Spool

Gauge	Stranding	O.D.	Auveco Part No						
			Red	White	Black	Blue	Green	Yellow	Brown
18	16 x 30	.092	<b>12423</b>	<b>12424</b>	<b>12425</b>	<b>12426</b>	<b>12427</b>	<b>12428</b>	<b>15256</b>
16	19 x 29	.104	<b>12429</b>	<b>12430</b>	<b>12431</b>	<b>12432</b>	<b>12433</b>	<b>12434</b>	<b>15257</b>
14	19 x 27	.117	<b>12435</b>	<b>12436</b>	<b>12437</b>	. . . .	<b>12439</b>	<b>12440</b>	<b>15258</b>
12	19 x 25	.142	<b>12441</b>	<b>12442</b>	<b>12443</b>	<b>12444</b>	<b>15259</b>	<b>15260</b>	. . . .
10	19 x 23	.175	<b>12445</b>	. . . .	<b>12447</b>	<b>12448</b>	. . . .	<b>15263</b>	. . . .

### 1000 Foot Spool

Gauge	Stranding	O.D.	Auveco Part No	
			Blue	Yellow
14	19 x 27	.117	<b>15275</b>	<b>15277</b>

# Sec. 12

## SPOOLED FUSIBLE LINK WIRE

The lower the gauge number, the thicker the wire (i.e. 10 ga. is thicker than 16 ga.)

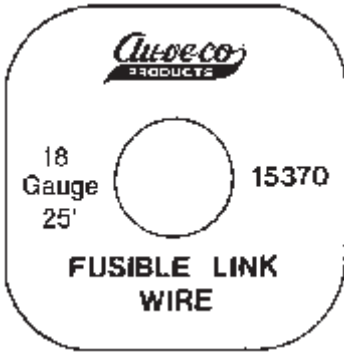

A fusible link is a special section of low tension cable installed by an OEM and designed to open a circuit when subjected to extreme current overload. Its purpose is to minimize wiring system damage when such an overload accidentally occurs in those circuits protected by the fusible link. A short circuit causes the fusible link to act as an element in a "slow-blow" fuse. A fusible link is not intended to be used in place of a fuse but only where a fuse cannot be economically employed. Our fusible line wire meets the requirements of SE J-156 and the insulation has the characteristics as listed for EAE, SE J-1128 Type SXL. The vehicle manufacturer should be consulted about questions on fusible link length and size. General practice has been for a fusible link to be 4 gauges smaller than the circuit wire. Example: if the circuit wire is 12 gauge, use a 16 gauge fusible link. Final determination should be based on O.E.M. application.

Note: Extreme care should be taken to always replace a fusible link with the same gauge and length as installed by the manufacturer.

Auveco Part No.	Gauge	Color*	Length	Replaces	Unit Pkg.
18773	20	Gray or Rust	25 Ft.	GM: 6292997	1 Spool
15370	18	Blue or Rust	25 Ft.	GM: 6293702	1 Spool
15371	16	Black or Rust	25 Ft.	GM: 6292996	1 Spool
15372	14	Gray or Rust	25 Ft.	GM: 6292995	1 Spool
16935	12	Blue or Rust	25 Ft.	GM: 6293923	1 Spool
18193	10	Rust	25 Ft.	GM: 12077140	1 Spool
20484	8	Black or Rust	25 Ft.		1 Spool

\*Color may vary at manufacturer's option.

### Universal Fusible Links



Auveco Part No.	Gauge	Length	Replaces	Unit Pkg.
12627	18	9"	Chry: 3843392 & other 18 Ga. links	5
12628	16	9"	GM: 6292996, 8903489 Ford D3AZ-14526-E & other 16 Ga. links	5
12629	14	9"	GM: 6292995, 8903488 Ford D3AZ-14526D & other 14 Ga. links	5
17465	12	9"	GM: 6293923	5
17464	10	9"	GM: 12077140	5

### Test Clips



Type 1

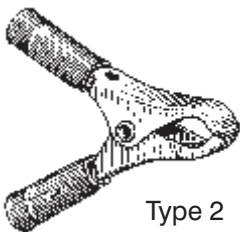

Type 2

Auveco Part No.	Type	Description	Unit Pkg.
20478	1	10 Amp, Alligator Clip, Nickel Plated, 2" Long	5
16969	2	10 Amp, Red Insulation, 2-1/4" Long	5
16970	2	10 Amp, Black Insulation, 2-1/4" Long	5
16971	2	1 Each of 16969 & 16970	1 Pair
16972	2	30 Amp, Red Insulation, 3" Long	5
16973	2	30 Amp, Black Insulation, 3" Long	5
16974	2	1 Each of 16972 & 16973	1 Pair
16975	2	50 Amp, Red Insulation, 3" Long	5
16976	2	50 Amp, Black Insulation, 3" Long	5
16977	2	1 Each of 16975 & 16976	1 Pair

# BATTERY CABLE & TERMINALS

## Battery Cable

**Sec. 12**



Bare Copper Standard Conductor, covered with tough black Polyvinyl Chloride insulation. The thick jacket is easy to strip, resistant to moisture, weather, oil and acids.

Auveco Part No.	Gauge	Stranding	O.D.	Unit Pkg.
11392	4	49 x 21	.375	25' Roll
13850	1/0	133 x 21	.530	25' Roll
13851	2/0	133 x 20	.590	25' Roll



### Solderless Battery Cable Terminals

Tin Plated Copper

Auveco Part No.	Cable Size	Post Size	Unit Pkg.
11360	No. 6 AWG	Universal	2
11361	No. 4 AWG	Universal	2
11362	No. 1 AWG	Positive	2
11363	No. 1 AWG	Negative	2
11364	No. 1/0 AWG	Positive	2
11365	No. 1/0 AWG	Negative	2
11366	No. 2/0 AWG	Positive	2
11367	No. 2/0 AWG	Negative	2
15858	No. 3/0 AWG	Positive	2
15859	No. 3/0 AWG	Negative	2

Note: Use w/ Auveco Tool No. 7996 or 7997

### Engine Ground & Bonding Strap



**19499**

Replacement for body to engine block straps. Solves light dimming problems by grounding charging system. Also reduces radio noise. Copper braided wire with tin-plated brass ring terminals. 8" long. 10 Gauge. 5/16" - 3/8" stud size ring terminal.

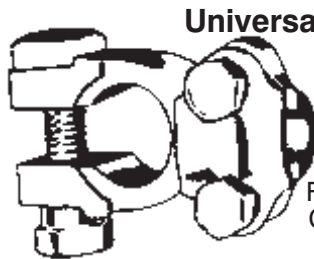

### Universal Battery Terminal

**9948**

For Positive & Negative Posts  
Cable Range 8 thru 2/0 AWG

UNIT PACKAGE: 2

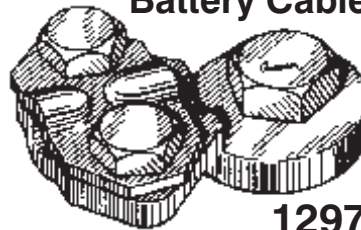

### Universal Side Mount Battery Cable Terminal

**12975**

Fits all small diameter cables - both positive and negative.

UNIT PACKAGE: 2

### Marine Battery Terminals

Lead Plated Brass Terminal  
Nickel Plated Grade 2 Steel Wing Nut  
Zinc Plated Grade 2 Steel Bolt & Nut

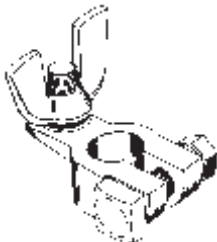

**8772**

For Positive Posts  
3/8"-16 Stud

UNIT PACKAGE: 5

**8773**

For Negative Posts  
5/16"-18 Stud

UNIT PACKAGE: 5

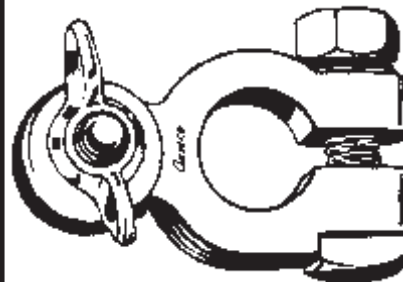

### All Lead Terminal

**10808**

Zinc Plated Steel Bolt & Nuts  
5/16"-18 Stud

UNIT PACKAGE: 2

# Sec. 12

# COMPRESSION BATTERY CABLE TERMINALS

All clamps and lugs are made of cast copper • All clamps, lugs and fasteners are tin plated

Assemble with common hand tools.

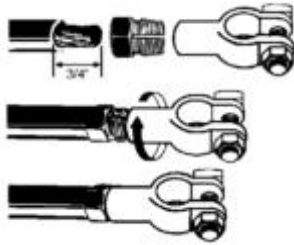
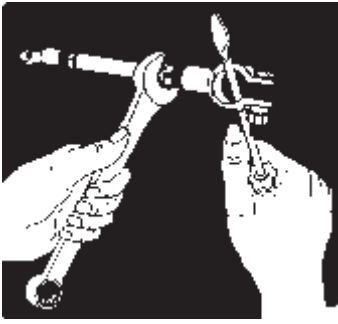

### Three Easy Steps

1. Strip 3/4" of insulation from the end of the cable. Insert bared wire into the compression nut.
2. Thread terminal on compression nut.
3. Grip compression nut with wrench and turn the terminal until the compression nut seats. With larger gauges you may want to hold the terminal in a vise.

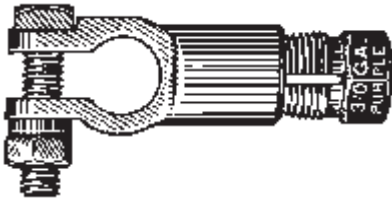

### Straight Clamp

Auveco Part No.	Cable Gauge	Desc.	Color	Unit Pkg.
15602	.....4	.....Neg.	.....Gray	.....2
15603	.....4	.....Pos.	.....Gray	.....2
15604	.....1&2	.....Neg.	.....Green	.....2
15605	.....1&2	.....Pos.	.....Green	.....2
15606	.....1/0	.....Neg.	.....Black	.....2
15607	.....1/0	.....Pos.	.....Black	.....2
15608	.....2/0	.....Neg.	.....Orange	.....2
15609	.....2/0	.....Pos.	.....Orange	.....2
15610	.....3/0	.....Neg.	.....Purple	.....2
15611	.....3/0	.....Pos.	.....Purple	.....2

### Flag Clamp

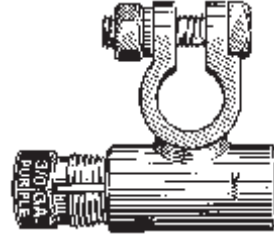

Auveco Part No.	Cable Gauge	Desc.	Color	Unit Pkg.
15612	.....1/0	.....Neg.	.....Black	.....2
15613	.....1/0	.....Pos.	.....Black	.....2
15615	.....2/0	.....Pos.	.....Orange	.....2



### Stud/Side Terminal

Auveco Part No.	Cable Gauge	Color	Unit Pkg.
15626	.....4	.....Gray	.....2
15628	.....1/0	.....Black	.....2
15630	.....3/0	.....Purple	.....2



### Heavy Wall Copper Lug

Auveco Part No.	Cable Gauge	Hole Size	Color	Unit Pkg.
15618	.....4	.....3/8"	.....Gray	.....2
15619	.....1&2	.....3/8"	.....Green	.....2
15620	.....1/0	.....3/8"	.....Black	.....2
15621	.....1/0	.....1/2"	.....Black	.....2
15622	.....2/0	.....3/8"	.....Orange	.....2
15623	.....2/0	.....1/2"	.....Orange	.....2
15624	.....3/0	.....3/8"	.....Purple	.....2
15625	.....3/0	.....1/2"	.....Purple	.....2

### Compression Nut



Auveco Part No.	Cable Gauge	Color	Unit Pkg.
15632	.....2/0	.....Orange	.....5

# BATTERY TERMINALS



## Top Stud Battery Terminals (Crimp Type Battery Rings)

100% Pure Copper w/Tin Plating • Fully Annealed  
A single, double or 3-way connection can be made by stacking parts.

UNIT PACKAGE: 5

Auveco Part No.	Cable Size	Length	Stud Size
12767	4 Ga.	1-1/2"	3/8"
12768	2 Ga.	1-3/4"	3/8"
12769	1 Ga.	1-3/4"	3/8"
12770	1/0 Ga.	2"	3/8"
14464	2/0 Ga.	2"	3/8"
14465	3/0 Ga.	2"	3/8"
14466	4/0 Ga. .559 I.D.	2-1/4"	3/8"
14467	4/0 Ga. .625 I.D.	2-1/2"	3/8"

■ For Rope Stranded 4/0 Cable  
(most common construction)



## Copper Battery Cable Lugs

Auveco Part No.	Cable Size	Stud Size	Unit Pkg.
5794	4 Ga.	3/8"	25
11463	4 Ga.	5/16"	25
11464	2 Ga.	3/8"	10
11465	1 Ga.	3/8"	10
5795	1 Ga.	3/8"	25
5796	1/0 Ga.	3/8"	25
8771	1/0 Ga.	1/2"	10
11466	2/0 Ga.	3/8"	10
11467	2/0 Ga.	1/2"	10
11468	3/0 Ga.	1/2"	10

Use Auveco No. 7996 or No. 7997 Crimping Tool



## Butt Connector (Double Flared)

Pure Copper with Tin Plating

Applications: Field or shop splicing of battery cables and welding cables.

Auveco Part No.	Cable Size	Length	Unit Pkg.
11724	6 Ga.	1"	10
11725	4 Ga.	1-1/4"	10
11726	2 Ga.	1-1/4"	10
11727	1 Ga.	1-3/8"	5
11728	1/0 Ga.	1-1/2"	5
11729	2/0 Ga.	1-3/4"	5
11731	4/0 Ga.	1-7/8"	2

Use Auveco Crimping Tool No. 7997



### Brass Side Terminal Battery Bolt & Connector

**15184**

3/8-16 Thread  
Overall Length:  
1-1/4"

UNIT PACKAGE: 1



### Zinc Plated Battery Side Terminal Bolt

**11083**  
(8917444)

Thread Size 3/8-16  
Overall Length:  
1-1/8"  
GM

UNIT PACKAGE: 10



**19199**

(12004188)  
Zinc

Battery Side Terminal Bolt  
Thread Size: 3/8"-16  
Overall Length: 1-3/4"  
GM

UNIT PACKAGE: 5



## Battery Terminal Bolt & Nut

Zinc Chromate

Auveco Part No.	Size	Unit Pkg.
3186	5/16"-18 x 1-1/4" Bolt W/Collared Nut	100
8003	5/16"-18 x 1-1/4" Bolt W/Hex Nut	50
8870	5/16"-18 x 1-1/2" Bolt W/Collared Nut	100
14974	5/16"-18 x 1-1/4" Bolt Only	50
14975	5/16"-18 Collared Nut Only	50

# Sec. 12

## BATTERY TERMINALS

### Heavy Duty Battery Cable Terminal Ends For Stud-Type Batteries

Double Barrel

Truck Auto  
H.D. Equipment  
Marine

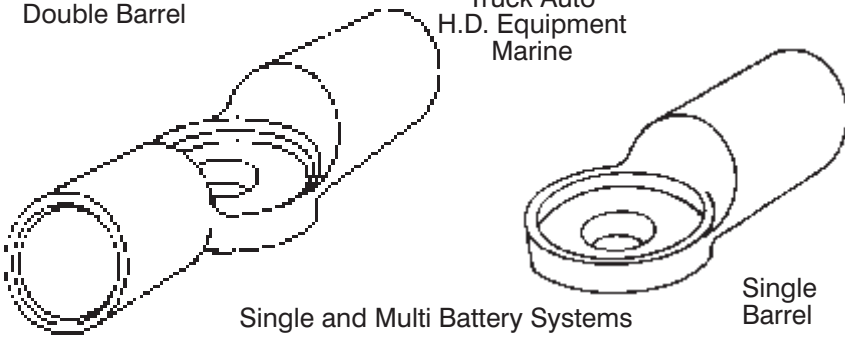

Single and Multi Battery Systems

Single Barrel

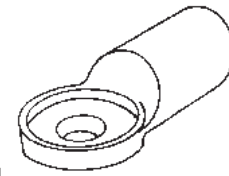

3/8 Stud Size  
Copper/Plated

Auveco Part No.	Cable Size	Unit Pkg.
-----------------	------------	-----------

13810	1/0	2
13811	2/0	2
13812	3/0	2

### Cable Terminal End Kits in 1 and 3/0 Sizes

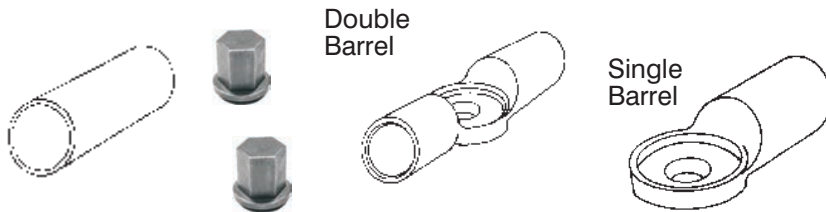

Double Barrel

Single Barrel

3/8 Stud Size  
Copper/Plated

Auveco Part No.	Cable Size	Unit Pkg.
-----------------	------------	-----------

13814	2/0	1
13815	3/0	1

Each Kit Contains The Following:

- 2 crimpable, copper terminals
- 2 battery terminal nuts
- 1 piece of red (+) heat-shrink tubing
- 1 piece of black (-) heat shrink tubing

### 13817

1/0 Cable Size  
2 - Auveco 13810 - Single Barrel  
Nuts/Shrink Tubing

UNIT PACKAGE: 1 Kit

### 13822

3/0 Cable Size  
2 - Auveco 13815 - Double Barrel  
Nuts / Shrink Tubing

UNIT PACKAGE: 1 Kit



### 13816

Battery Hold Down Nuts  
3/8-16  
Stainless Steel  
(18-8)

UNIT PACKAGE: 4

### Suggested Terminal Assemblies

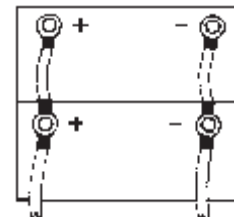
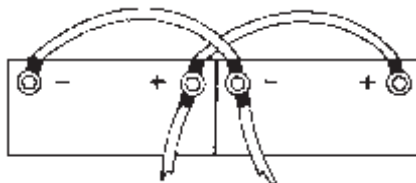
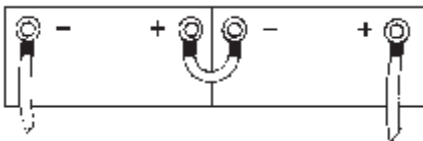



**3-Way Battery Tool**

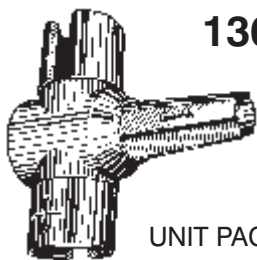

**13628**

This tool cleans both posts and terminals. Tapered reamer assures correct angles on terminal clamps.

UNIT PACKAGE: 1

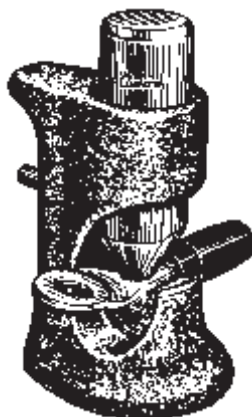

**7996**

Use with vise or hammer  
Crimps cable range  
8 to 4/0 gauge

UNIT PACKAGE: 1

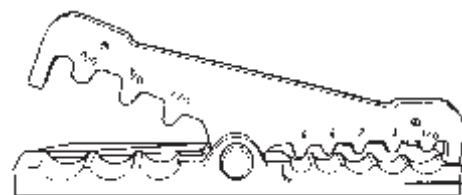

**7997**

Use with vise or hammer  
Crimps terminal and lugs in  
cable range 6 through 4/0

UNIT PACKAGE: 1



**15039**

**Anti-Corrosion  
Protectant**

A non-drying coating protectant, formulated especially for battery terminals and other exposed electrical connections. Each 8 oz. can features a brush-on applicator that cannot clog like aerosol coatings.

UNIT PACKAGE: 1 Can

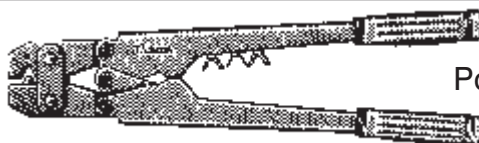

**15036**

**Power Crimper Tool**

UNIT PKG: 1

Crimps battery terminals, splices and heavy-duty rings from 6 gauge through 4/0. Creates a maximum strength crimp that exceeds U.L. cable pullout requirements. Applications up to 600 volts. Unique system of die-insert shims reduces cost, size and weight. Shims are stored on the handle. Length: 17-3/4"

**3M Vinyl Electrical Tape**

Made In U.S.A.

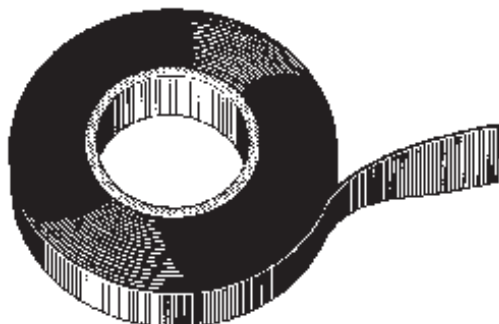

.007" Thick x 3/4" Wide x 60 Ft. Long

**16527**

Unit Package: 5 Rolls

**16578**

Unit Package: 15 Rolls

General purpose vinyl insulating tape with excellent resistance to abrasion, moisture, alkalis, acid, copper corrosion and varying weather conditions. Can be used as a primary electrical insulation for all wire and cable splices rated up to 600 volts.

**Linerless Self-Bonding  
Rubber Tape**

Replace heat shrink tubing with a safe, tight, long-lasting seal that withstands temperature extremes from -50° to 300°F. No heat guns or open flames needed. No paper liner to mess with.

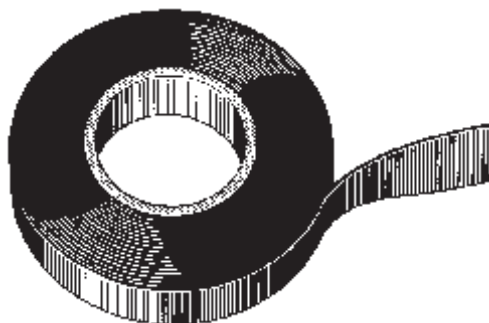

**14389**

3/4" x 15 Ft.  
.030" Thick

UNIT PACKAGE: 1 Roll

Self-bonding rubber tape can be used to replace heat shrink tubing in most automotive applications. It is stretched when applied and retains its elasticity to ensure a tight seal at all points. There isn't a possibility of a leak due to unevenly applied heat as can happen with shrink tubing.

The tape is unaffected by salt spray and common automotive fluids. As long as it is stretched when it is applied, it will not unravel after application due to its self-bonding characteristics.

# Sec. 12

# HEAT SHRINK TUBING

Made In The U.S.A.



## Black Thin Wall Heat Shrink Tubing

- 2 To 1 Shrink Ratio
- Highly Flame Retardant (VW-1)d
- Cross linked Polyolefin

Auveco Part No.	Size	Pre-Shrink I.D.	Post-Shrink I.D.	Length	Unit Pkg.	Auveco Part No.	Size	Pre-Shrink I.D.	Post-Shrink I.D.	Length	Unit Pkg.
18693	3/64"	.046"	.023"	.6"	25	18699	3/8"	.375"	.187"	.6"	15
18694	1/16"	.063"	.031"	.6"	25	18700	1/2"	.500"	.250"	.6"	15
18695	3/32"	.093"	.046"	.6"	25	18701	3/4"	.750"	.375"	.6"	10
18696	1/8"	.125"	.062"	.6"	25	18702	1"	1.00"	.500"	.6"	10
18697	3/16"	.187"	.093"	.6"	25	18703	1-1/2"	1.50"	.750"	.6"	5
18698	1/4"	.250"	.125"	.6"	25	18704	2"	2.00"	1.00"	.6"	5

## Adhesive Lined Heat Shrink Tubing

- 4.5 To 1 Shrink Ratio
- Cross linked, Semi-Rigid Polyolefin Outer Jacket
- Hot-Melt Adhesive Inner Wall Adheres To All Major Types Of Wire
- Environmentally Seals & Insulates
- Meets O.E.M. Specs: Ford: ESB M99 D56 A1 Chrysler: MS-DB56

Auveco Part No.	Pre-Shrink I.D.	Post-Shrink I.D.	Length	Color	Unit Pkg.
18705	.225"	.050"	3-1/2"	Black	10
18706	.293"	.065"	3-1/2"	Black	10
18707	.427"	.095"	3-1/2"	Black	10
18708	.700"	.175"	3-1/2"	Black	5

## Dual Wall Self-Sealing Heat Shrink Tubing

- Provides Waterproofing & Environmental Protection
- & Strain Relief Properties

Auveco Part No.	Size	Pre-Shrink I.D.	Post-Shrink I.D.	Length	Color	Unit Pkg.
16665	22-14 Ga.	.188"	.062"	.12"	Black	4
16666	12-10 Ga.	.250"	.083"	.12"	Black	4
18733	14-10 Ga.	.400"	.150"	.6"	Black	4
19102	14-10 Ga.	.400"	.150"	.6"	Black	25
18734	14-10 Ga.	.400"	.150"	.6"	Red	4
19103	14-10 Ga.	.400"	.150"	.6"	Red	25
18735	8-1 Ga.	.750"	.220"	.6"	Black	4
19104	8-1 Ga.	.750"	.220"	.6"	Black	25
18736	8-1 Ga.	.750"	.220"	.6"	Red	4
19105	8-1 Ga.	.750"	.220"	.6"	Red	25
18737	2-4/0 Ga.	1.100"	.375"	.6"	Black	4
19106	2-4/0 Ga.	1.100"	.375"	.6"	Black	25
18738	2-4/0 Ga.	1.100"	.375"	.6"	Red	4
19107	2-4/0 Ga.	1.100"	.375"	.6"	Red	25

## Part No. 18887

Six inch lengths of black thin wall, cross linked polyolefin, heat shrink tubing in a durable translucent polypropylene box. The tubing has 2:1 shrink ratio.



Part No.	Qty.	Size	Pre-Shrink I.D.	Post-Shrink I.D.
18697	36	3/16"	.187"	.093"
18698	24	1/4"	.250"	.125"
18699	12	3/8"	.375"	.187"
18700	6	1/2"	.500"	.250"
18701	4	3/4"	.750"	.375"
18702	4	1"	1.00"	.500"

UNIT PACKAGE: 1

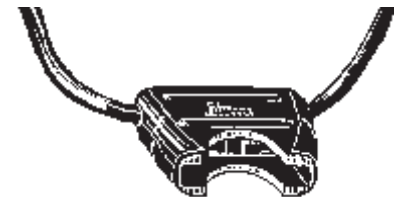
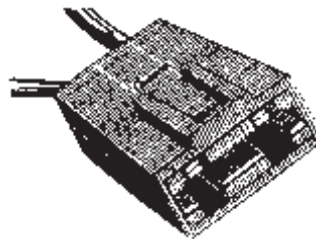
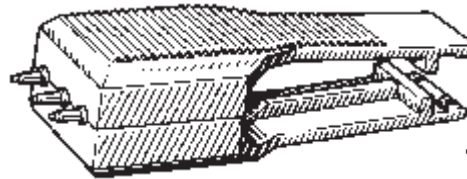
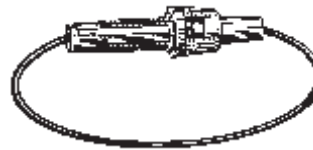
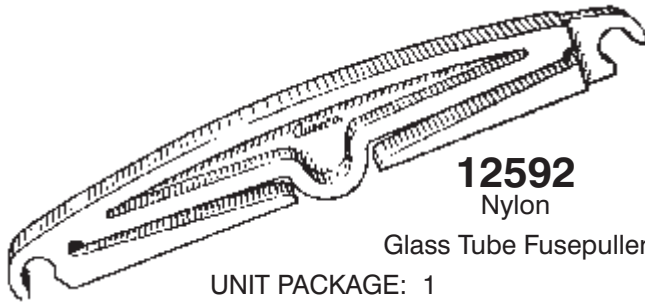

## Environmentally Sealed Blade Type Fuse Holder

Also Used As Fuel Pump Fuseholder on GM Vehicles  
(Fuse Not Included)

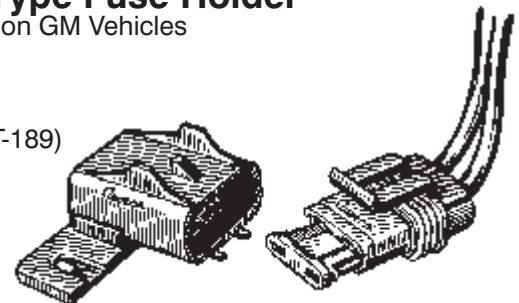
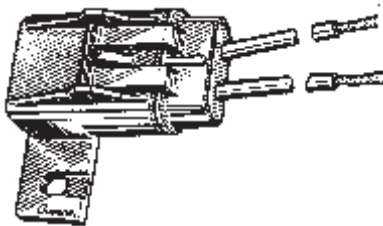

Electrical system protection for fleets, construction equipment, aircraft service vehicles, outdoor power equipment and marine installations.

Resistant to moisture, salt spray and engine compartment fluids. Withstands 50 g physical shock. Operating temperature range from -40° to 125°C.

- Nylon Body with Latching Cap
- Silicone Rubber Seals at Wires and Cap
- 12 Gauge SE/GPT Wire Leads
- 3 to 30 Amp Capacity - Type ATC/ATO Fuses
- 5" Long Wire Leads

## Sec. 12

### Sealed Fuse Holders For ATM Mini® Fuses

Not Actual Size

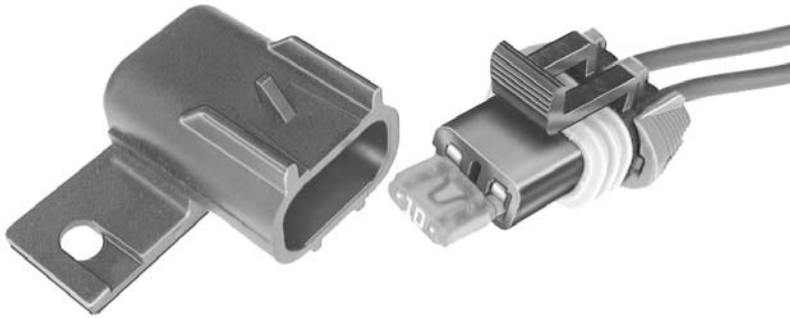

#### 20206

20, 25 & 30 Amp Capacity  
10" Long 12 Ga. Cross-Linked  
Polyethylene Leads  
Fuse Not Included

UNIT PACKAGE: 1

#### 20207

2-15 Amp Capacity  
10" Long  
16 Ga. Cross-Linked  
Polyethylene Leads  
Fuse Not Included

UNIT PACKAGE: 1

### High Power Sealed Fuse Holder



#### 20320

For ATC & ATO Fuses  
40 Amp Capacity  
12" Long 10 Gauge 105 Strand  
EZ Flex Wire Leads  
Fuse Not Included

UNIT PACKAGE: 1

### In-Line Mini Fuse Fuseholder

A uniquely designed in-line fuseholder for Auveco mini fuses 16351-16360. Two part numbers cover all the different amperages and a variety of copper wire sizes.

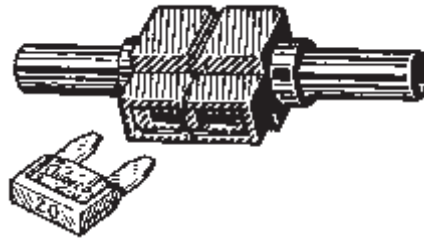

#### 17647

20 Amp. Maximum  
16-22 Ga. Wire  
Use With  
Auveco Mini Fuses  
16351-16358

UNIT PACKAGE: 5

#### 17648

30 Amp. Maximum  
10-14 Ga. Wire  
Use With  
Auveco Mini Fuses  
16359-16360

UNIT PACKAGE: 5

#### Installation:

1. Strip standard copper wire 3/4" from end.
2. Twist stranded copper wire and insert fully into ends of holder to ensure crimping on bare wire. Avoid exposed bare wire.
3. Use Auveco crimping tools 7711 or 15035 and crimp on the matted areas of the terminal and extensions.

# Self-Stripping Fuseholder

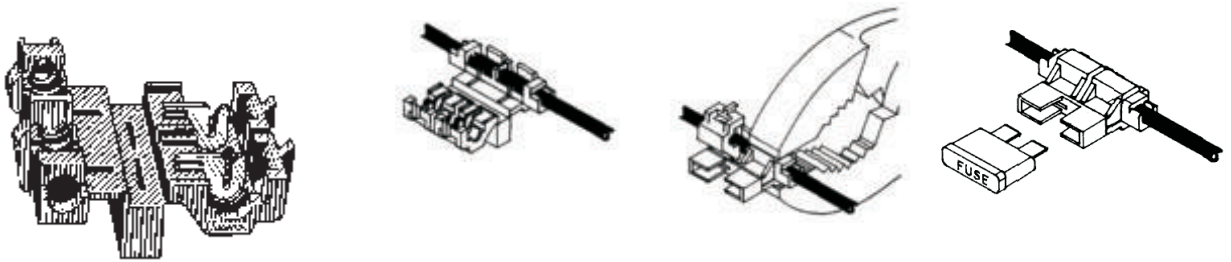

## 12977

Mates with most plug-in blade type fuses found in late-model domestic and some import cars. For 18-14 gauge copper wire.

- 32 volts maximum.
- 20 amp maximum with 14 gauge wire.
- 10 amp maximum with 16 gauge wire.
- 7.5 amp maximum with 18 gauge wire.

UNIT PACKAGE: 5

## Fuse Blocks

For use with SFE-20 Amp. fuse or any 3 AG series fuse. Phosphor bronze fuse clips. Brass screws

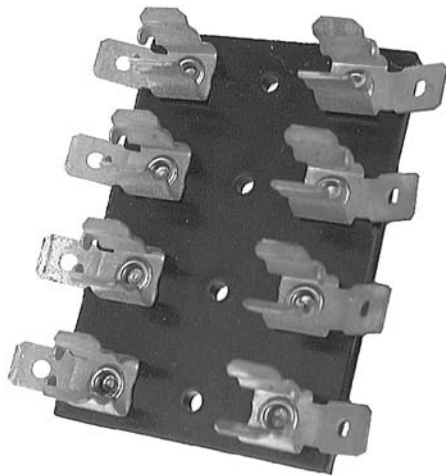

### 13443

Two Gang Fuse Block

UNIT PACKAGE: 1

### 13445

Four Gang Fuse Block

UNIT PACKAGE: 1

## Terminal/Junction Blocks

For marine and exposed applications. Brass nickel plated terminal links and binding head terminal screws. Moisture repellent molded ABS base with protective insulator barrier strips. 20 Amp rating.

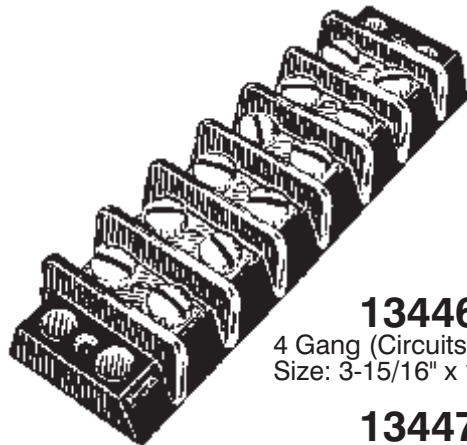

### 13446

4 Gang (Circuits)  
Size: 3-15/16" x 1-5/16" x 11/16"

### 13447

6 Gang (Circuits)  
Size 4-3/8" x 1-5/16" x 11/16"

### 13448

8 Gang (Circuits)  
Size: 5-1/2" x 1-5/16" x 11/16"

### 13449

10 Gang (Circuits)  
Size: 6-5/8" x 1-5/16" x 11/16"

UNIT PACKAGE: 1

# Sec. 12

## Fuses & Circuit Breakers

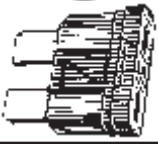

### ATC®/ATO® (Blade Type) Fuses

Auveco Part No.		Amp Rating	Color
Unit Pkg. 5	Unit Pkg. 25		
12534	12548	3	Violet
12535	12549	4	Pink
12536	12550	5	Tan
12537	12551	7-1/2	Brown
12538	12552	10	Red
12539	12553	15	Blue
12540	12554	20	Yellow
12541	12555	25	White
12542	12556	30	Green

### Glass Tube Fuses



Auveco Part No.	Size	Amp	Code	Unit Pkg.
18981	1/4" x 1-1/4"	2	AGC-2	5
17625	1/4" x 1-1/4"	3	AGC-3	5
17626	1/4" x 1-1/4"	5	AGC-5	10
17627	1/4" x 1-1/4"	7.5	AGC-7.5	10
12545	1/4" x 1-1/4"	10	AGC-10	5
12546	1/4" x 1-1/4"	15	AGC-15	5
18982	1/4" x 1-1/4"	20	AGC-20	5
12543	1/4" x 1-1/4"	20	SFE-20	5
18983	1/4" x 1-1/4"	25	AGC-25	5
12544	1/4" x 1-7/16"	30	SFE-30	5
12547	1/4" x 1-1/4"	30	AGC-30	5

### Maxi™ Fuses

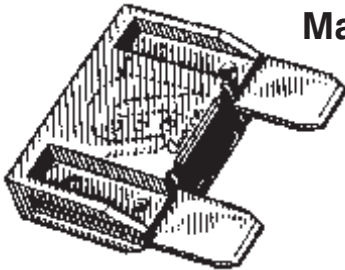

Auveco Part No.	Amp Rating	Color	Unit Pkg.
15505	20	Yellow	2
15506	30	Green	2
15507	40	Orange	2
15508	50	Red	2
15509	60	Blue	2

### Mini Fuses



Auveco Part No.	Amp Rating	Color	Unit Pkg.
16351	2	Gray	5
16352	3	Purple	5
16353	4	Pink	5
16354	5	Tan	5
16355	7.5	Brown	5
16356	10	Red	5
16357	15	Blue	5
16358	20	Yellow	5
16359	25	White	5
16360	30	Green	5

### Midi Fuses



Auveco Part No.	Amp Rating	Unit Pkg.
18984	50	2
18985	80	2

### Mega Fuses



Auveco Part No.	Amp Rating	Unit Pkg.
18986	100	2
18987	125	2
18988	150	2
18989	175	2
18990	200	2
18991	225	2
18992	250	2

### Circuit Breakers Automatic Re-Set



Type 1

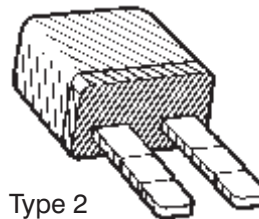

Type 2

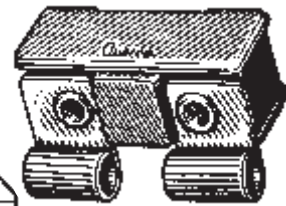

Type 3

Auveco Part No.	Type	Specifications	Unit Pkg.
15046	1	30 Amps At 12 Volts	5
18518	2	10 Amps At 12 Volts	2
18519	2	15 Amps At 12 Volts	2
18520	2	20 Amps At 12 Volts	2
18521	2	30 Amps At 12 Volts	2
18522	2	40 Amps At 12 Volts	2
15047	3	20 Amps At 12 Volts	5
15048	3	30 Amps At 12 Volts	5
15049	3	40 Amps At 12 Volts	5

**PAL™ (Pacific Auto Link) Fuses**



Type 1

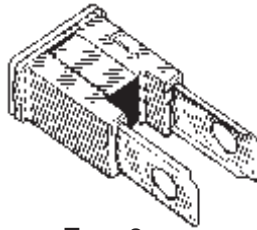

Type 2

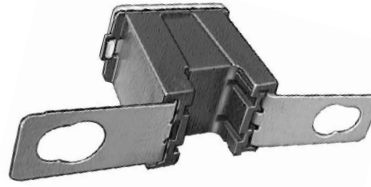

Type 3



Type 4

Auveco Part No.	Type	Amp Rating	Color	Unit Pkg.	Auveco Part No.	Type	Amp Rating	Color	Unit Pkg.
<b>20560</b>	1	20	Beige	1	<b>15933</b>	3	40	Green	1
<b>15926</b>	1	30	Pink	1	<b>15934</b>	3	70	Brown	1
<b>15927</b>	1	40	Green	1	<b>19295</b>	3	80	Black	2
<b>19294</b>	1	50	Red	3	<b>19296</b>	3	100	Blue	2
<b>15928</b>	1	60	Yellow	1	<b>20551</b>	4	20	Blue	2
<b>15929</b>	2	30	Pink	1	<b>20552</b>	4	30	Pink	2
<b>15930</b>	2	60	Yellow	1	<b>20553</b>	4	40	Green	2
<b>15931</b>	2	80	Black	1	<b>20554</b>	4	50	Red	2
<b>15932</b>	3	30	Pink	1	<b>20555</b>	4	60	Yellow	2

**FUSE ASSORTMENTS**



**18997**  
Maxi™/Mini® Fuse Assortment  
66 Fuses

Contents:

Five Mini 2 amp fuses	Five Mini 25 amp fuses
Five Mini 3 amp fuses	Ten Mini 30 amp fuses
Five Mini 4 amp fuses	One Maxi 20 amp fuse
Five Mini 5 amp fuses	Two Maxi 30 amp fuses
Five Mini 7.5 amp fuses	One Maxi 40 amp fuse
Five Mini 10 amp fuses	One Maxi 50 amp fuse
Five Mini 15 amp fuses	One Maxi 60 amp fuse
Ten Mini 20 amp fuses	

UNIT PACKAGE: 1



**18996**  
ATO®/Mini® Fuse Assortment  
80 Fuses & 1 Fuse Puller/Tester

Contents:

Ten ATO 15 amp fuses	Ten Mini 15 amp fuses
Ten ATO 20 amp fuses	Ten Mini 20 amp fuses
Ten ATO 25 amp fuses	Ten Mini 25 amp fuses
Ten ATO 30 amp fuses	Ten Mini 30 amp fuses
One Fuse Puller/Tester	

UNIT PACKAGE: 1



**18994**  
ATO® Blade Type Fuse Assortment  
40 Fuses and 1 Fuse Puller/Tester

Contents:

Five ATO 3 amp fuses	Five ATO 20 amp fuses
Five ATO 5 amp fuses	Five ATO 25 amp fuses
Five ATO 7.5 amp fuses	Five ATO 30 amp fuses
Five ATO 10 amp fuses	One Fuse Puller/Tester
Five ATO 15 amp fuses	

UNIT PACKAGE: 1

## Sec. 12

### FUSE ACCESSORIES



**14474**

Blade Type Fuse Tap

A quick, easy alternative to direct wiring when tapping the "hot side" of the fuse block.

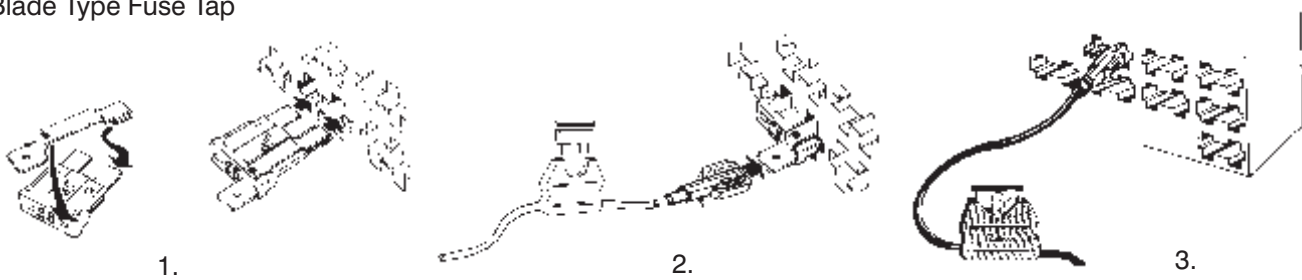

The blade type fuse tap is made of sturdy brass and is engineered for quick connect and disconnect of accessories such as C.B. radios, hand-held lights, etc. Installation can be completed in three steps.

1. Use a test probe to locate the "hot side" of the circuit in the fuseblock. Then snap the tap over the corresponding "hot side" blade of the fuse. Insert the fuse into the fuseblock.
2. Crimp one end of an in-line fuse holder (with the fuse installed) to a fully insulated nylon .250" female quick-connect terminal. Attach the other fuse holder lead to the accessory wire.
3. Complete the connection by sliding the female quick-connect terminal onto the protruding tab of the tap.

UNIT PACKAGE: 25

### Mini Fuse Blade Type Fuse Tap

"Tapping" fuse blocks equipped with mini fuses are No Problem!



**17686**

Now there's a quick, easy alternative to direct wiring for tapping the "hot side" of mini fuse style fuse blocks. The blade type fuse tap is made of .016" thick sturdy brass with a .187" (3/16") wide tab. It is engineered for quick connect and disconnect of accessories.

Insert  
fuse  
blade  
into tap  
slot

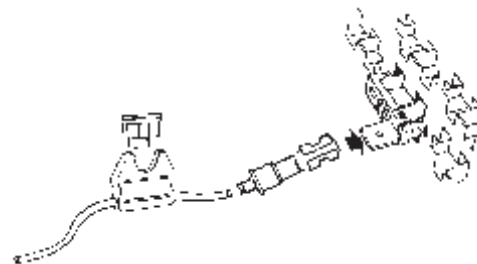

1. Locate "hot side" of circuit in the fuse block with a test probe. Slide the tap onto the corresponding "hot side" blade of the fuse.
2. Insert the fuse into the fuseblock
3. Crimp one end of an in-line fuse holder (with the fuse installed) to the appropriate Auveco female connector 8781 (16-14 ga.) or 12159 (22-18 ga.). Attach the other fuse holder lead to the accessory wire. Slide the female connector onto the protruding tab of the tap.

UNIT PACKAGE: 50



**GM SOCKET ASSY. & HARNESS CONNECTORS**

Use with butt connectors on pages 142 - 149 • Illustrations Not Actual Size



**9905**

(Chrys: 2496279; GM: 2973932; AMC: 3509575; IHC: 374985C1)

Instrument Panel Socket  
for 5/8" Hole  
Bulb No. 158, 194, 194A  
GM, Chrysler, AMC & International

UNIT PACKAGE: 10

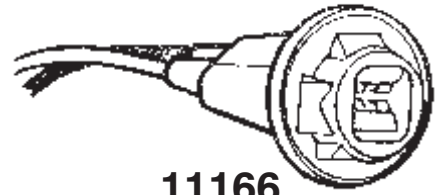

**11166**

(GM: 6294015, 8901283, 8918527; Ford: D40Z-13410E, D7AZ-13412A, D7FZ-13412A)

Side Marker & License Plate Lights  
Bulb Nos. 158, 194, 194A  
GM & Ford

UNIT PACKAGE: 1

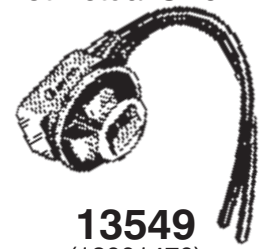

**13549**

(12001470)

Side Marker, License,  
Tail & Stop Lights  
Bulb Nos. 158, 194, 194A  
GM

UNIT PACKAGE: 1



**12237**

(Chrys: 3744750; GM: 12004311, 25015169; Ford: C80Z-13711A)

Instrument Panel Socket  
for 1/2" Hole  
Bulb No. 158, 194, 194A  
GM, Ford & Chrysler

UNIT PACKAGE: 2

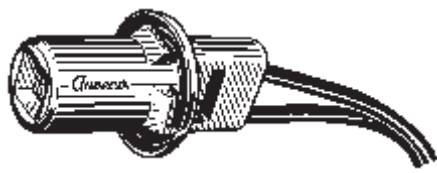

**13540**

(8912750)

Side Marker, License,  
Parking & Tail Lights  
Bulb Nos. 158, 194, 194A  
GM

UNIT PACKAGE: 1



**13558**

(6298892, 6298886)

Side Marker Assembly  
Bulb Nos. 158, 194, 194A  
GM

UNIT PACKAGE: 1

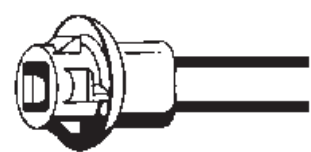

**9883**

(GM: 6298886, 6298892, 6298935; Ford: D0DZ-15A434B)

Side Marker Assembly  
Bulb Nos. 158, 194, 194A  
GM & Ford

UNIT PACKAGE: 5

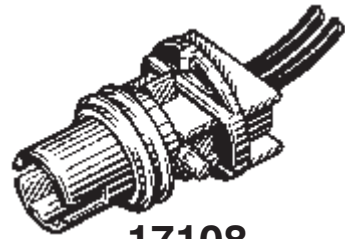

**17108**

(12083007)

Marker Light Pigtail  
Bulb No. 24  
GM 1988-On

UNIT PACKAGE: 1



**8755**

(2978302)

License Plate, Back-Up &  
Instrument Panel Lights  
Bulb Nos. 63, 67, 81, 87, 89, 93, 209,  
1003, 1073, 1129, 1133 & 1141  
For 1-1/8" Hole  
GM

UNIT PACKAGE: 10

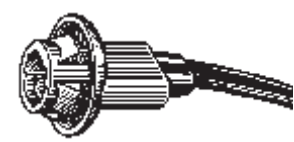

**11441**

Instrument Panel and Marker Lights  
Bulb Nos. 158, 194, 194A  
GM & Ford

UNIT PACKAGE: 10



**18924**

(12083460)

Rear Side Marker Lights  
Bulb number 158, 194, 194A  
GM 1985-On

UNIT PACKAGE: 1



**8759**

Signal, Park, Stop & Tail Lights  
Bulb Nos. 198, 1016, 1034,  
1154 & 1157  
For 3/4" Hole  
GM

UNIT PACKAGE: 5

# Sec. 12

## GM SOCKET ASSY. & HARNESS CONNECTORS

Use with butt connectors on pages 142 - 149 • Illustrations Not Actual Size

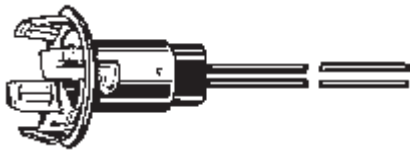

**8756**  
(2974309)

Signal, Park, Stop & Tail Lights  
Bulb Nos. 198, 1016, 1034,  
1154 & 1157  
For 1-1/8" Hole  
GM

UNIT PACKAGE: 10



**8750**  
(2974309, 2983540,  
6299087 & 8912698)

Signal, Park, Stop & Tail Lights  
Bulb Nos. 1034, 1154 & 1157  
GM

UNIT PACKAGE: 5

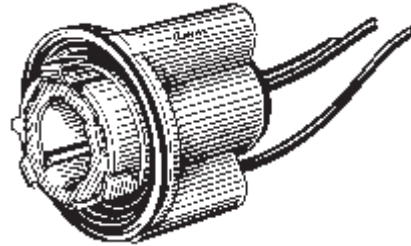

**11476**  
(8903203, 8914823)

Park, Stop & Tail Lights  
Bulb No. 1157  
GM

UNIT PACKAGE: 5

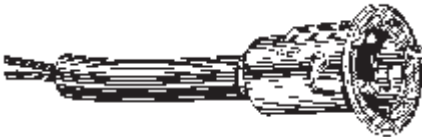

**8754**

Weatherproof Signal, Park,  
Stop & Tail Lights  
Bulb Nos. 198, 1016, 1034,  
1154 & 1157  
For 3/4" Hole  
GM

UNIT PACKAGE: 5

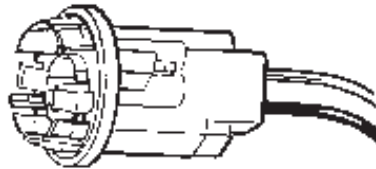

**11157**  
(AMC: 4486948;  
GM: 2983540, 8912698;  
6299087)

Signal, Park, Stop & Tail Lights  
Bulb Nos. 1034, 1154 & 1157  
GM & AMC

UNIT PACKAGE: 1

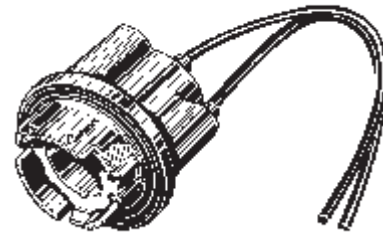

**13544**  
(12003878, 8904251)

Back-up, Cornering & Turn Signal  
Bulb No. 1156  
GM

UNIT PACKAGE: 1

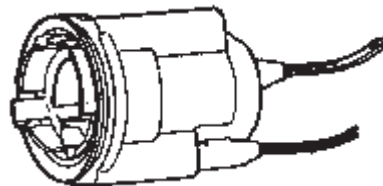

**11156**  
(GM: 5963268, 8904437,  
8909518; IHC: 57172C91)

Back-up & Cornering  
Bulb No. 1156  
GM & IHC

UNIT PACKAGE: 1

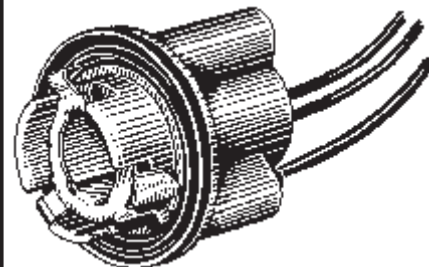

**11446**  
(8902487, 8903283,  
8907701 & 8909908)

Stop & Tail Lights  
Bulb No. 1157  
GM

UNIT PACKAGE: 5

**Please Order In Unit  
Package Quantity  
Not Pieces**

# GM SOCKET ASSY. & HARNESS CONNECTORS

**Sec. 12**

Use with butt connectors on pages 142 - 149 • Illustrations Not Actual Size

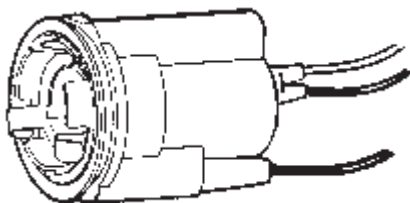

**11154**

(8903202, 8914822)

Park, Stop & Tail Lights  
Bulb Nos. 1034, 1154 & 1157  
GM

UNIT PACKAGE: 1

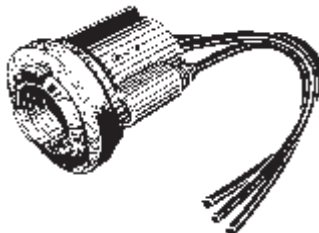

**13543**

(8919916,  
12013813)

Park, Stop & Tail Lights  
Bulb No. 1157  
GM

UNIT PACKAGE: 1



**18923**

(12027133)

Back-Up Lights  
GM 1982-On

UNIT PACKAGE: 1

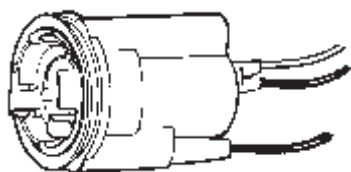

**11475**

(8903202, 8914822)

Park, Stop & Tail Lights  
Bulb Nos. 1034, 1154 & 1157  
GM

UNIT PACKAGE: 5

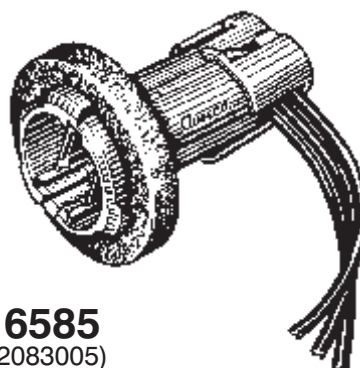

**16585**

(12083005)

Signal, Park, Stop & Tail Lights  
Bulb No. 3057 Dual Filament  
Wedge Base  
GM

UNIT PACKAGE: 1

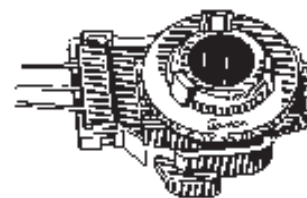

**12600**

(GM: 12003759; AMC: 812893)

90° Pigtail & Socket Assembly  
Bulb Nos. 1016, 1034, 1154 & 1157  
GM & AMC

UNIT PACKAGE: 1

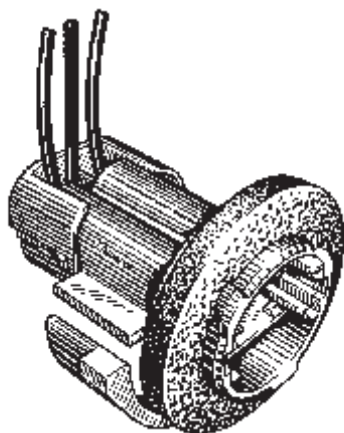

**17175**

(12076946)

Ivory Shell

Stop, Tail, Turn & Parking Lights  
Bulb No. 3057 & 3157  
GM 1988-On

UNIT PACKAGE: 1

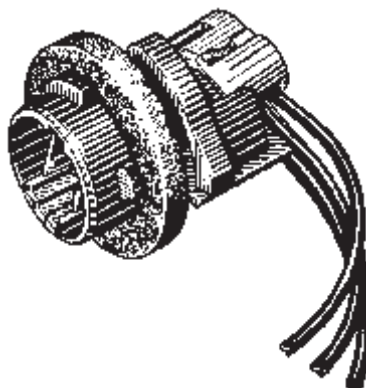

**16586**

(12083006)

Signal, Park, Stop & Tail Lights  
Bulb No. 3057 Dual Filament  
Wedge Base  
GM

UNIT PACKAGE: 1

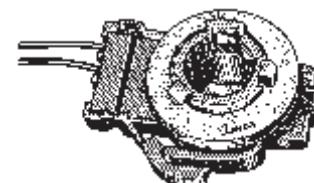

**13545**

(12003758)

Tail Lights  
Single Contact  
Bulb Nos. 87, 93 & 1156  
GM

UNIT PACKAGE: 1

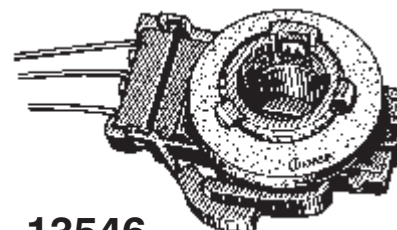

**13546**

(12003757)

Signal & Park Lights  
Bulb Nos. 194, 198 & 2057  
GM

UNIT PACKAGE: 1

**Sec. 12****GM SOCKET ASSY. & HARNESS CONNECTORS**

Use with butt connectors on pages 142 - 149 • Illustrations Not Actual Size

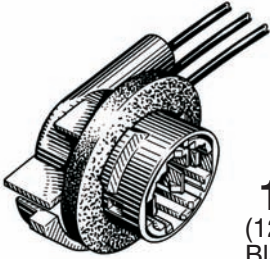
**17172**  
(12083680)  
Black ShellStop, Tail, Turn & Parking Lights  
Bulb No. 3057 & 3157  
GM: 1989-On

UNIT PACKAGE: 1

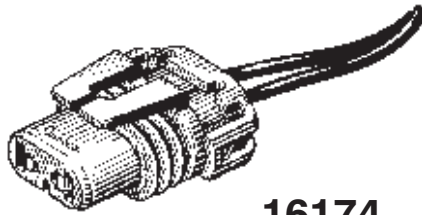
**16174**  
(GM: 12101897)Headlight Socket Assembly  
For Low Beam 9006 Halogen Bulb  
Single Indexing Groove  
GM, Ford, AMC & Imports

UNIT PACKAGE: 4

**17112**

Not Supplied By O.E.M.

Distributor Module Pigtail  
Used on GM distributor module  
1987466 on 6 cylinder 2.8 engines  
1985-On

UNIT PACKAGE: 1

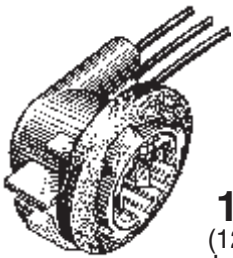
**17173**  
(12083689)  
Ivory ShellStop, Tail, Turn & Parking Lights  
Bulb No. 3057 & 3157  
GM 1990-On

UNIT PACKAGE: 1

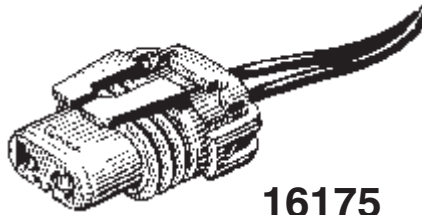
**16175**  
(GM: 12101898)Headlight Socket Assembly  
For High Beam 9005 Halogen Bulb  
Two Indexing Grooves  
GM, Ford, AMC & Imports

UNIT PACKAGE: 4

**18916**  
(12085483)Ignition Module,  
Crankshaft Coolant Sensor &  
Power Steering Pressure Switch  
Harness Connector  
GM 1986-On

UNIT PACKAGE: 1

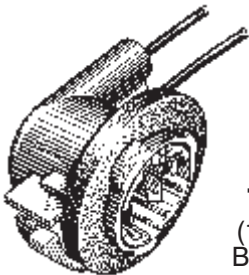
**17174**  
(12085330)  
Brown ShellBack-Up Lights  
Bulb No. 2456 & 3156  
GM 1990-On

UNIT PACKAGE: 1

**16967**  
(12101906)Heater Blower connector pigtail on  
GM 1985-On. Can also be used as  
an ATO/ATC Fuse Holder.  
Features two 9" long 12 gauge  
GXL wire leads.

UNIT PACKAGE: 1

**18870**  
(12101855)Direct Ignition  
Vehicle Speed Sensor  
Harness Connector  
GM  
1987-On

UNIT PACKAGE: 1

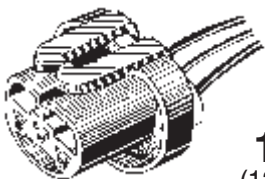
**14918**  
(12048369)Headlight Socket Assembly For  
High-Low 9004 & 9007 Halogen Bulb  
GM, Ford & Imports

UNIT PACKAGE: 1

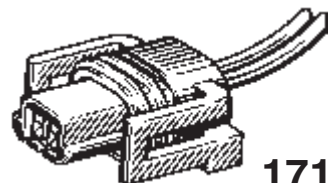
**17114**  
(12085496)Direct Ignition Throttle  
Body Injection Pigtail  
GM 1987-On

UNIT PACKAGE: 2

**18867**  
(12101880)Direct Ignition  
Harness Connector  
GM  
1987-On

UNIT PACKAGE: 1

# GM SOCKET ASSY. & HARNESS CONNECTORS

**Sec. 12**

Use with butt connectors on pages 142 - 149 • Illustrations Not Actual Size

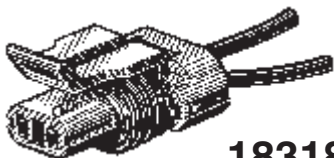

**18318**  
(12101857)

Air Divert Valve  
Harness Connector  
GM 1994-87

UNIT PACKAGE: 1

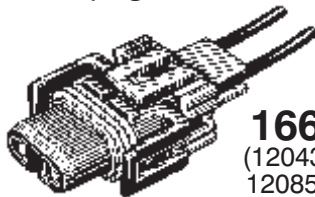

**16694**  
(12043215,  
12085498)

Cornering & Fog Light Socket  
For 881 Halogen Bulb  
GM

UNIT PACKAGE: 1

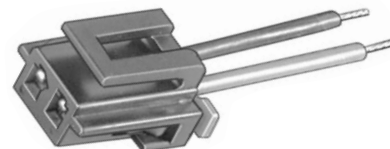

**18925**  
(25117765)

E.F.I. Fuel Pump  
Harness Connector  
GM w/ Fuel Pump  
In Gas Tank 1995-88

UNIT PACKAGE: 1

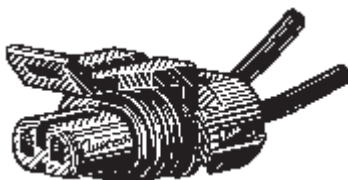

**18320**  
(12101856)

Air Switch Valve  
Harness Connector  
GM 1993-91

UNIT PACKAGE: 1

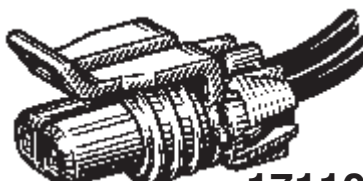

**17110**  
(12102747)

Windshield Washer Pump, Low  
Coolant Sensor Connector Pigtail  
GM Cars & Trucks 1987-On

UNIT PACKAGE: 1



**19891**

Not Available From O.E.M.

Windshield Wiper Motor  
Harness Connector  
GM 1994 - 86

UNIT PACKAGE: 1

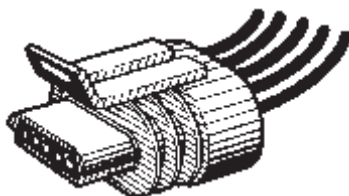

**17111**  
(12116958)

Horn Connector Pigtail  
Fits Horns 1999160, 1999161,  
10456327 and 10456328  
GM 1988-On

UNIT PACKAGE: 1

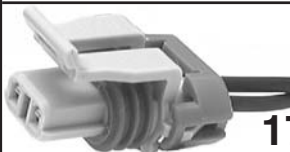

**16693**  
(12046624,  
12102620)

Replacement connector pigtail used  
with 1985-on GM Manifold Air  
Temperature Sensors including  
25036751. Features two 9" long 18  
gauge wire leads.

UNIT PACKAGE: 1



**17109**

(12085525, 12085527, 12085528,  
12101895, 12117361)

3 Wire Alternator Connector Pigtail  
Two 18 gauge and one 12 gauge  
leads. Can be used to replace two  
wire and single wire connector  
pigtails by taping  
(Do Not Cut) the appropriate unused  
leads.

GM 1986-On

UNIT PACKAGE: 1



**18868**  
(12085495)

Mass Air Flow Sensor  
Harness Connector  
GM  
1988-On

UNIT PACKAGE: 1



**18917**  
(12085538)

Camshaft Sensor  
Harness Connector  
Buick, Olds & Pontiac  
1992-86

UNIT PACKAGE: 1

# Sec. 12

## GM SOCKET ASSY. & HARNESS CONNECTORS

Use with butt connectors on pages 142 - 149 • Illustrations Not Actual Size

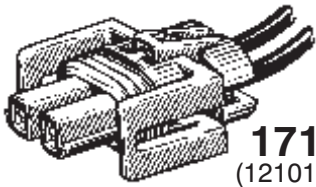

**17113**  
(12101937)

A.C. Compressor  
Clutch Pigtail  
GM Cars & APV 1989-On

UNIT PACKAGE: 1

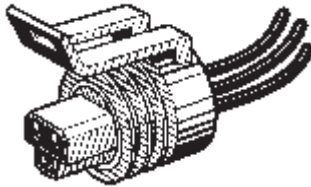

**18527**

(12102748)

Throttle Position Sensor  
Harness Connector  
GM 1994-90

UNIT PACKAGE: 1

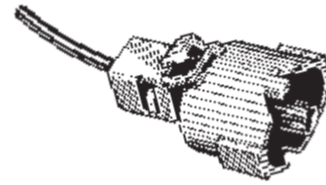

**14580**

(12102621)

Radiator Fan Sensor Switch  
Harness Connector  
Fits electric cooling fan switches  
3040674, 14043275 and 14043276.  
GM 1980-On

UNIT PACKAGE: 1

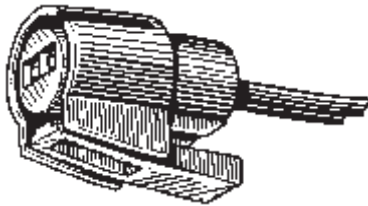

**16513**

(GM: 12085521)

Replacement connector pigtail used  
on GM V-5 Air Conditioning  
Switches. Fits GM High Pressure  
Switch 6551917 and others. Index  
slot is at the one o'clock position.  
Features two 9" long 18 gauge wire  
leads.

UNIT PACKAGE: 1

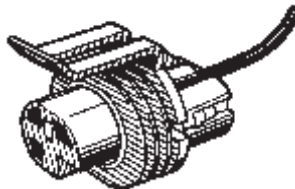

**18529**

(12085500)

Oil Pressure Switch Harness  
Connector  
Chevrolet Beretta & Corsica 1987,  
Chevrolet Corvette 1994-90 and  
Pontiac Firebird 1988

UNIT PACKAGE: 1

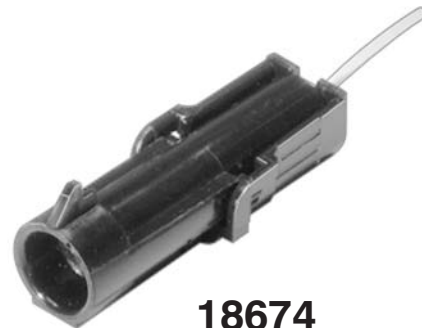

**18674**

(12126451)

Coolant Temperature  
Sensor Harness Connector  
Fits Sensor 10232601  
& 25037203  
GM 1987-On

UNIT PACKAGE: 1

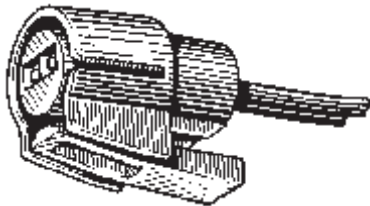

**16514**

(12085503)

Replacement connector pigtail  
used on GM V-5 Air Conditioning  
Compressor Pressure Cut-off  
Switches. Fits GM low Pressure  
Switch 6551946 and others  
Index slot is at three o'clock position  
Features two 9" long 18 gauge  
wire leads

UNIT PACKAGE: 1

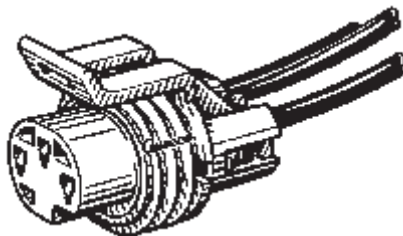

**17197**

(12085499)

Oil Pressure Switch  
Connector Pigtail  
GM 1992-87

UNIT PACKAGE: 1

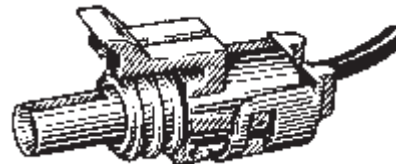

**17107**

(12117385)

Oxygen Sensor Connector Pigtail  
Fits The Following Oxygen Sensors

8990469	(AC-Delco AFS13P)
8990625	(AC-Delco AFS15P)
8990741	(AC-Delco AFS16P)
10042186	(AC-Delco 213-15)
25105107	(AC-Delco AFS20)
25105901	(AC-Delco AFS21)
25106073	(AC-Delco AFS22)

Most GM Models 1982-On

UNIT PACKAGE: 1

# GM SOCKET ASSY. & HARNESS CONNECTORS

**Sec. 12**

Use with butt connectors on pages 142 - 149 • Illustrations Not Actual Size

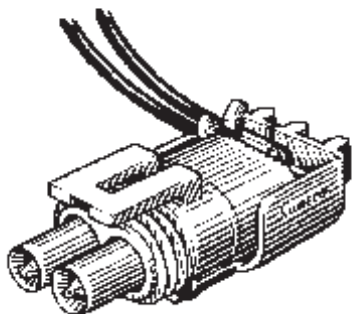

**16962**

Not Supplied By O.E.M.

Harness Connector used with GM Mixture Control Solenoid Kits 17067343, 17067344 and 17111102 on 2 & 4 barrel Rochester Varajet Carburetors. For GM cars and trucks 1980-On

UNIT PACKAGE: 1



**17198**

Not Supplied By O.E.M.

Throttle Position Sensor Harness Connector Fits Sensor 17078051, 17078448 & 17078481 On 2 & 4 Barrel Rochester Carburetors GM 1990-80

UNIT PACKAGE: 1



**18918**

(12085506)

Fuel Injection Idle Air Control Valve, Stoplight Switch & Torque Converter Clutch Valve Harness Connector GM 1985-On

UNIT PACKAGE: 1



**19882**

(12085485)

Back-Up Light Switch & Speed Sensor Harness Connector Used With Switch 23049569, PT107 & IACV Motor GM 1971-On

UNIT PACKAGE: 1

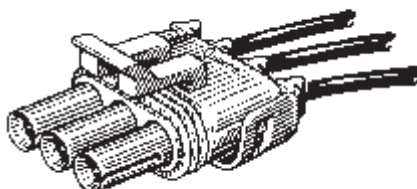

**16964**

(12085502)

Green

Manifold Absolute Pressure (MAP) Harness Connector. Fits GM MAP Sensor 16137039 on GM vehicles (38 models) 1982-on

UNIT PACKAGE: 1

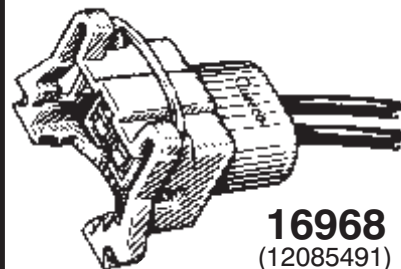

**16968**

(12085491)

Fuel Injector Solenoid Harness Connector. Fits GM Multi-Port Fuel Injector 1711799 on 2.8 and 3.1 liter engines (27 models) 1986-On Also fits Fuel Injectors on Ford, Chrysler & Imports (Bosch)

UNIT PACKAGE: 1



**16965**

(12085507)

Gray

Air Conditioner Pressure Switch Harness Connector Used on GM vehicles (28 models) 1988-84

UNIT PACKAGE: 1

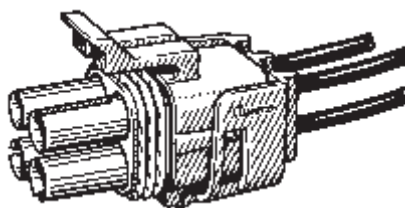

**17199**

(12085533)

Transmission Converter Clutch Harness Connector 3 Wires (Cavity "C" is Not Wired) GM 1990-84

UNIT PACKAGE: 1

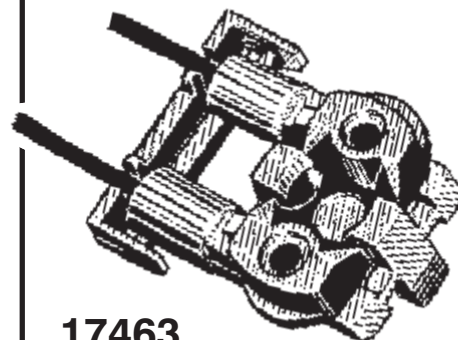

**17463**

(12102568)

Fuel Injector Connector For TBI (Throttle Body Injector) Systems All GM (Including Trucks) 1978-On

UNIT PACKAGE: 1

**Sec. 12**

**GM SOCKET ASSY. & HARNESS CONNECTORS**

Use with butt connectors on pages 142 - 149 • Illustrations Not Actual Size



**18319**  
(12101914)

Power Window  
Motor  
Harness Connector  
GM 1993-90

UNIT PACKAGE: 1



**15368**  
(12085480)  
Black

Trunk Release Switch Connector &  
Electric Choke Harness Connector  
GM (w/o Fuel Injection) 1987-On  
10" Lead of 18 Ga. Cross-Link  
Primary Wire

UNIT PACKAGE: 5

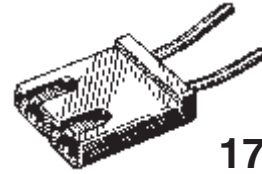

**17690**  
(12101903)

Washer Fluid Sensor  
Harness Connector  
Also Used On Back-Up  
Light Switch & A.C.  
Compressor Switch  
GM 1985-On

UNIT PACKAGE: 5

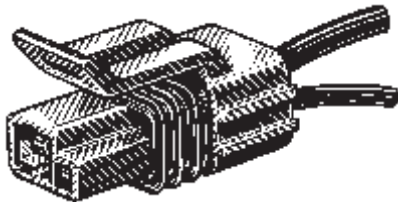

**18316**  
(12101933)

Ignition Coil  
Harness Connector  
GM 1995-87

UNIT PACKAGE: 1



**15369**  
(12010031)  
Gray

Electric Choke Harness Connector  
GM 1987-77  
10" Lead of 18 Ga. Cross Link  
Primary Wire

UNIT PACKAGE: 5



**18872**  
(12085487)

Windshield Wiper Motor  
Harness Connector  
GM  
1984-On

UNIT PACKAGE: 1

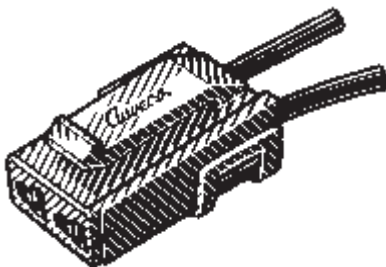

**18315**  
(12085489)

Cooling Fan Temperature  
Sensor Harness Connector  
GM 1987-85

UNIT PACKAGE: 1

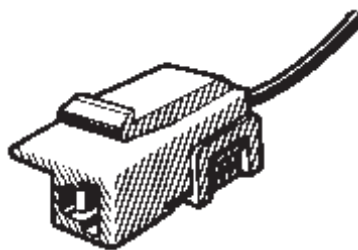

**18526**  
(12117353)

Fuel Pump, Instrument Panel &  
General Purpose  
Harness Connector  
GM 1995-90

UNIT PACKAGE: 2

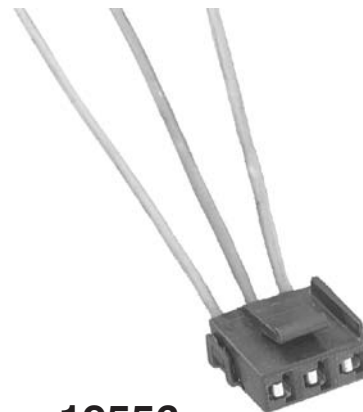

**19556**  
(12117354)

Harness Connector  
Brake Light Switch 25529862  
GM: Camaro, Caprice, Century,  
Firebird, Lumina APV, K,S,  
& T Truck, Silhouette  
& Trans Sport 1991-On

UNIT PACKAGE: 1



# GM SOCKET ASSY. & HARNESS CONNECTORS

Sec. 12

Use with butt connectors on pages 142 - 149 • Illustrations Not Actual Size

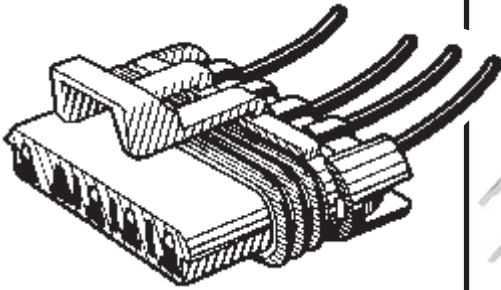

**18525**

Not Supplied  
By O.E.M.

Tail Light Harness Connector  
GM Full Size Pick-Up Trucks  
1995-88

UNIT PACKAGE: 1

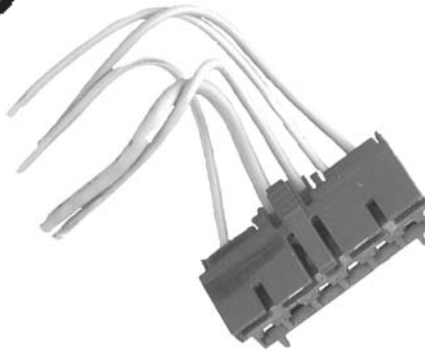

**19554**

(12101927)

Harness Connector  
Headlight and Ignition  
Switches 15693540, 10471139,  
1070881, 26693547 & 15693548  
GM: Astro, Safari, C, K,  
S, T Trucks, Kodiak &  
Grand Am 1990-On

UNIT PACKAGE: 1

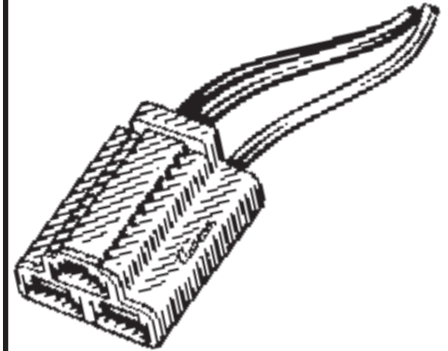

**11440**

(GM: 2962510)

Air Conditioner Blower Relay  
Harness Connector  
18 Ga. Wire  
GM, AMC & Chrysler

UNIT PACKAGE: 10



**11444**

Voltage Regulator Pigtail  
GM

UNIT PACKAGE: 10

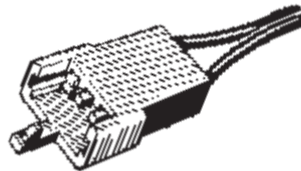

**14752**

(8900444)

GM Speaker Connector  
Used to restore connections at  
speakers or radio in the event of  
damage or theft. Leads are 10" long  
18 gauge wire, color-coded red and  
brown to match the OEM harness.

UNIT PACKAGE: 5

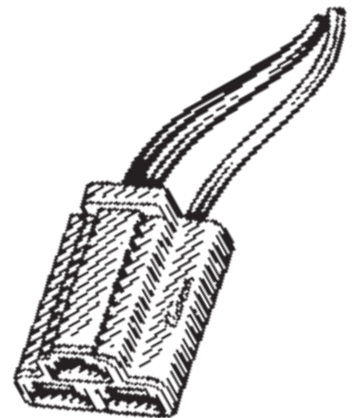

**18317**

Not Supplied  
By O.E.M.

Blower Motor  
Harness Connector  
Heavy Duty Applications  
12 ga. Type GXL Wire  
GM, Ford & Chrysler

UNIT PACKAGE: 1

**Sec. 12**

**GM SOCKET ASSY. & HARNESS CONNECTORS**

Use with butt connectors on pages 142 - 149 • Illustrations Not Actual Size



**11443**  
(6294493)

Alternator Harness Connector  
w/Transistorized Alternators  
GM

UNIT PACKAGE: 10

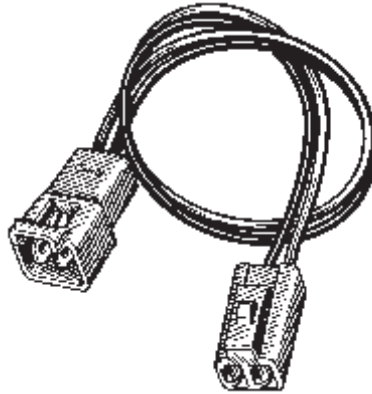

**13547**  
(2977373)

Alternator Extender  
Harness Connector With  
Female Connector  
GM 1974-62

UNIT PACKAGE: 2

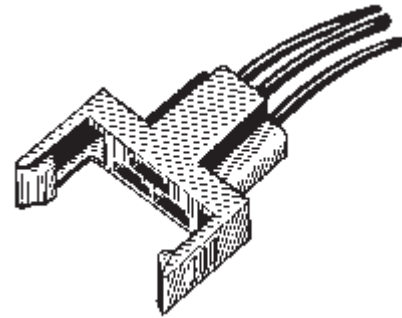

**11436**

Dimmer Switch  
Harness Connector  
GM

UNIT PACKAGE: 10

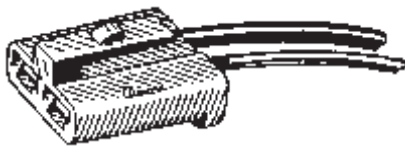

**17691**  
(12101909)

Alternator Harness Connector  
Two 16 Ga. Leads  
Fits Delcotron Models 10-SI, 12-SI,  
15-SI & 27-SI With  
Internal Voltage Regulator  
GM 1980-71

UNIT PACKAGE: 5

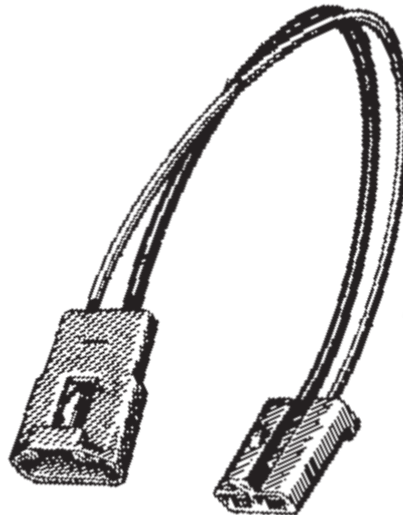

**13548**  
(6294493)

Alternator Extender  
Harness Connector With  
Female Connector  
GM  
1971-On

UNIT PACKAGE: 2



**19555**  
(12102757)

Harness Connector  
Headlight Dimmer Switch  
GM Most Models 1990-On

UNIT PACKAGE: 1

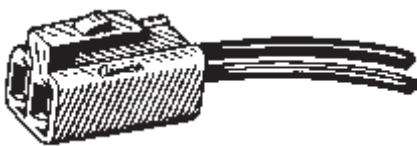

**11442**  
(2977373)

Alternator Harness Connector  
w/External Voltage Regulators  
GM 1977-62

UNIT PACKAGE: 10

**GM SOCKET ASSY. & HARNESS CONNECTORS**

Use with butt connectors on pages 142 - 149 • Illustrations Not Actual Size



**18871**  
(12101939)

Harness Connector For Cooling Fan,  
Fuel Pump, Starter Interrupt Relay &  
Fan Control Switch  
Cadillac  
1988-On

UNIT PACKAGE: 1



**19553**  
(12101885, 12126460)

Harness Connector  
Various Relays: Door  
Locking Control Module  
Blower Motor & Auxiliary Fan, etc.  
GM Most Models 1982-On

UNIT PACKAGE: 1

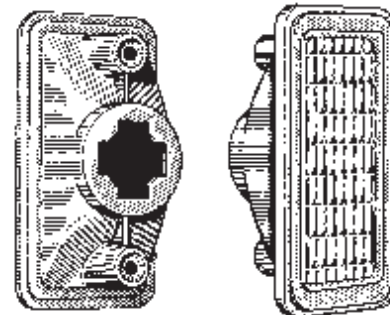

**9885**  
(916638, 916581)  
Plastic

Clear Lens  
Front Fender Marker  
Lamp Assembly  
Use w/Auveco No. 9883  
GM

UNIT PACKAGE: 1

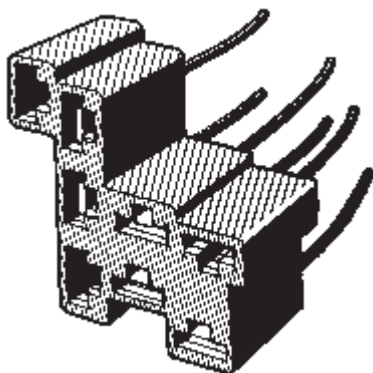

**18530**  
Not Supplied  
By O.E.M

Headlight Switch  
Harness Connector  
Fits Switch 1995217  
GM 1991-68

UNIT PACKAGE: 1

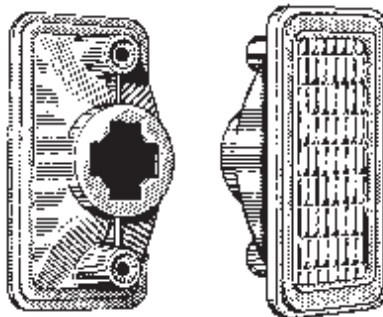

**9884**  
(916638, 916581)  
Plastic

Amber Lens  
Front Fender Marker Lamp Assembly  
Use w/Auveco No. 9883  
GM

UNIT PACKAGE: 1

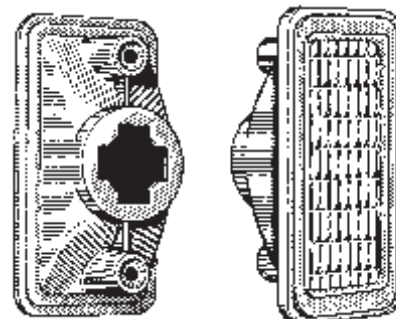

**9916**  
(916632)  
Plastic

Red Lens  
Rear Quarter Marker Lamp Assembly  
Use w/Auveco 9883  
GM

UNIT PACKAGE: 1

**Inquire About Our  
FasTrack Cost  
Recovery Program  
For Body Shops**

**Sec. 12**

**FORD SOCKET ASSY. & HARNESS CONNECTORS**

Use with butt connectors on pages 142 - 149 • Illustrations Not Actual Size



**12237**

(Chrys: 3744750; GM: 12004311, 25015169; Ford: C80Z-13711A)

Instrument Panel Socket  
For 1/2" Hole  
Bulb No. 194  
GM, Ford & Chrysler

UNIT PACKAGE: 2

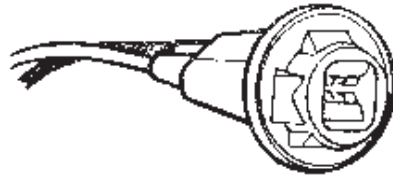

**11166**

(GM: 6294015, 8901283, 8918527;  
Ford: D40Z-13410E, D7AZ-13412A,  
D7FZ-13412A)

Side Marker & License Plate Lights  
Bulb Nos. 158, 194, 194A  
GM & Ford

UNIT PACKAGE: 1

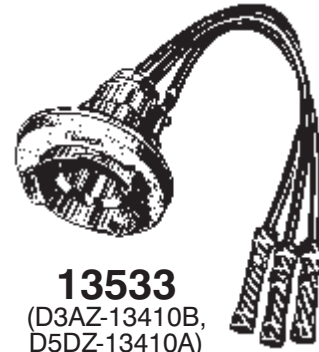

**13533**

(D3AZ-13410B,  
D5DZ-13410A)

Rear Lights  
Bulb No. 1157  
Ford

UNIT PACKAGE: 1

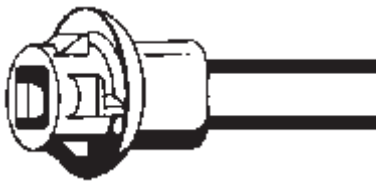

**9883**

(GM: 6298886, 6298892, 6298935;  
Ford: D0DZ-15A434B)

Side Marker Assembly  
Bulb Nos. 158, 194, 194a  
GM & Ford

UNIT PACKAGE: 5



**8761**

License Plate & Instrument  
Panel Lights  
Bulb Nos. 51, 53, 55, 57 & 57X  
For 5/8" Hole  
Ford

UNIT PACKAGE: 10



**13535**

(D3AZ-13410A)

Signal, Stop & Tail Lights  
Bulb No. 1156  
Ford

UNIT PACKAGE: 1

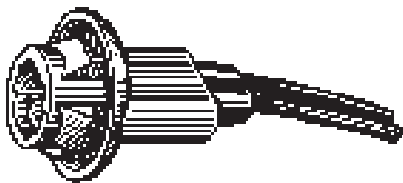

**11441**

Instrument Panel and Marker Lights  
Bulb Nos. 158, 194, 194A  
GM & Ford

UNIT PACKAGE: 10

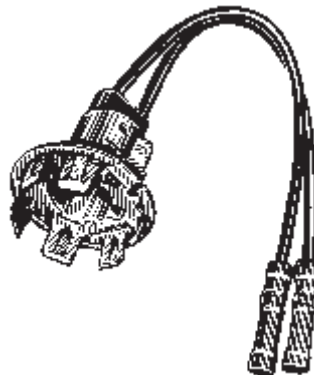

**13537**

(D1AZ-13410B)

Stop & Tail Lights  
With One Ground Male  
Blade Terminal  
Bulb Nos. 1034, 1154 & 1157  
Ford

UNIT PACKAGE: 1

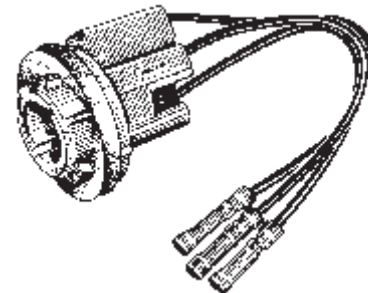

**14136**

(D70Z-13410-A)

Tail & Stop Lights  
Bulb No. 1157  
Ford

UNIT PACKAGE: 1

**FORD SOCKET ASSY. & HARNESS CONNECTORS**

Use with butt connectors on pages 142 - 149 • Illustrations Not Actual Size

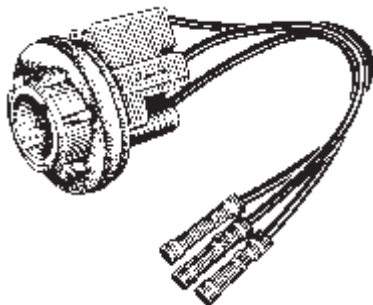

**14133**  
(D4LY-13410-A)

Tail & Stop Lights  
Bulb No. 1157  
Ford

UNIT PACKAGE: 1

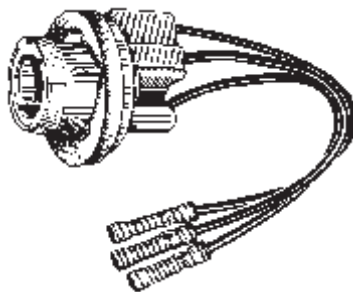

**14132**  
(D3AZ-13410-G)

Tail & Stop lights  
Bulb No. 1157  
Ford

UNIT PACKAGE: 1

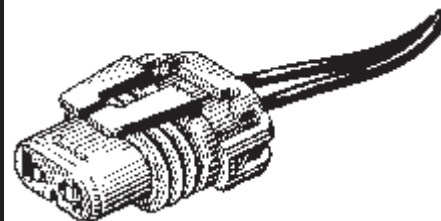

**16174**

Headlight Socket Assembly  
For Low Beam 9006 Halogen Bulb  
Single Indexing Groove  
GM, Ford, AMC & Imports

UNIT PACKAGE: 4

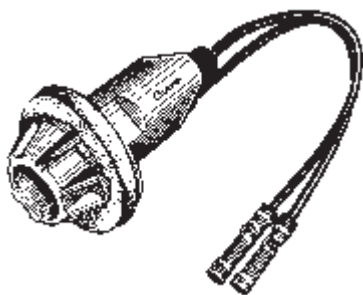

**14131**  
(D3AZ-13410-E)

Back-up/Cornering Lights  
Bulb No. 1141  
Ford

UNIT PACKAGE: 1

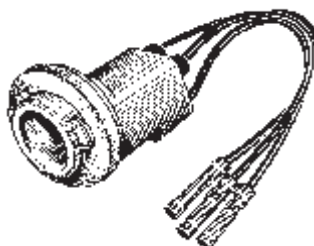

**14135**  
(D1FZ-13234-A)

Parking Lights  
Bulb No. 1157  
Ford

UNIT PACKAGE: 1

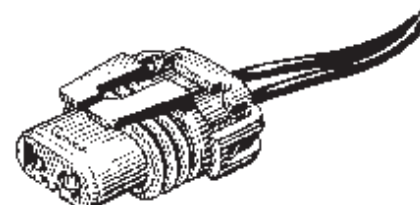

**16175**

Headlight Socket Assembly  
For High Beam 9005 Halogen Bulb  
Two Indexing Grooves  
GM, Ford, AMC & Imports

UNIT PACKAGE: 4

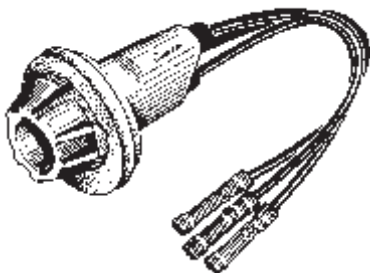

**14128**  
(D4OZ-13234-A)

Signal & Parking Lights  
Bulb No. 1157  
Ford

UNIT PACKAGE: 1

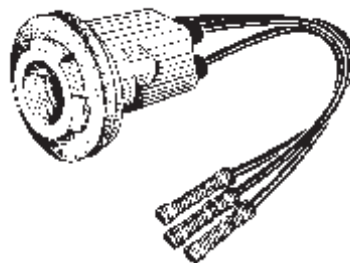

**14130**  
(D4ZZ-13234-A)

Signal & Parking Lights  
Bulb No. 1157  
Ford

UNIT PACKAGE: 1

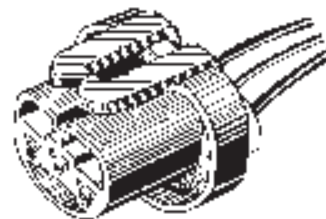

**14918**  
(12048369)

Headlight Socket Assembly For  
High-Low 9004 & 9007 Halogen Bulb  
GM, Ford & Imports

UNIT PACKAGE: 1

**Sec. 12****FORD SOCKET ASSY. & HARNESS CONNECTORS**

Use with butt connectors on pages 142 - 149 • Illustrations Not Actual Size

**19890**

Not Available From O.E.M.

Back-Up Light Switch  
Harness Connector  
Fits Switches C9TZ-15520C &  
SW-849  
Ford Trucks & T-Bird  
1967-On

UNIT PACKAGE: 1

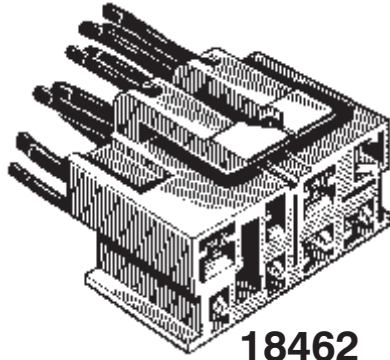
**18462**Not Supplied  
By O.E.M.

Headlight Switch  
Harness Connector  
Fits Switch E64Y-11654-A  
Mercury Sable With  
Rocker Type Knob  
1989-86

UNIT PACKAGE: 1

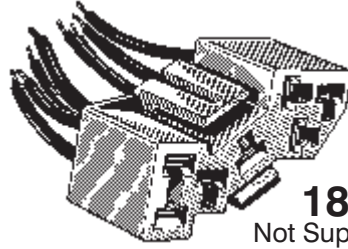
**18464**Not Supplied  
By O.E.M.

Turn Signal Switch  
Harness Connector  
Fits Switch E7FZ-13341-A  
Ford Tempo, Topaz, EXP, LN7, Capri,  
Mustang, LTD, Marquis,  
Escort & Lynx  
1994-85

UNIT PACKAGE: 1

**19125**Not Supplied  
By O.E.M.

Plugs Into Light Socket  
Base For Double Filament  
Wedge Type Bulbs  
Stop, Tail, Turn & Parking Lights  
Ford Ranger, Explorer & Econoline  
1991-On

UNIT PACKAGE: 1

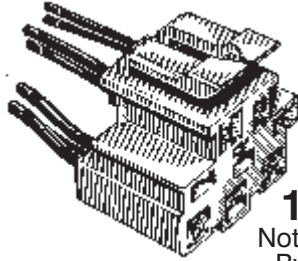
**18463**Not Supplied  
By O.E.M.

Headlight Switch  
Harness Connector  
Fits Headlight Switches  
E6DZ-11654A & F2DZ-11654A  
Ford Taurus & Mercury Sable  
With Rotary Knob  
1994-86

UNIT PACKAGE: 1

**20547**

Not Supplied By O.E.M.

Multi-Function Switch  
Harness Connector  
Fits 13K359 Switches E8DZ-B,  
E8ZZ-B, E9DZ-A,B,C, E90Y-D,  
E9SZ-B,D,E & F0ZZ-A,B  
Ford Taurus, Sable, T-Bird,  
Cougar and Continental  
1993 - 86

UNIT PACKAGE: 1

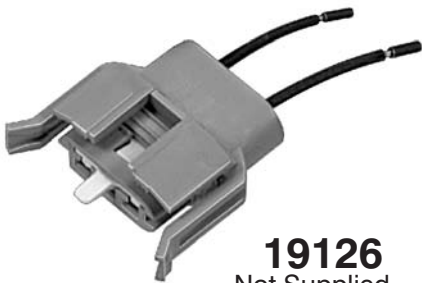
**19126**Not Supplied  
By O.E.M.

Plugs Into Light Socket Base For  
Single Filament Wedge Type Bulbs  
Back-Up Lights  
Ford Ranger, Explorer & Econoline  
1991-On

UNIT PACKAGE: 1

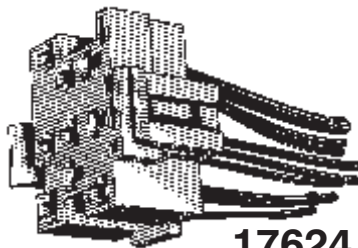
**17624**Not Supplied  
By O.E.M.

Headlight Switch Assembly  
Harness Connector  
Fits Instrument Panel  
Headlight Switch E7TZ-11654-C  
Ford Trucks: F150, F250, F350 &  
Bronco  
1991-87

UNIT PACKAGE: 1

**20548**

Not Supplied By O.E.M.

Multi-Function Switch  
Harness Connector  
Fits 13K359 Switches E8DZ-B,  
E8ZZ-B, E9DZ-A, B, C, E90Y-D,  
E9SZ-B, D, E & F0ZZ-A, B  
Ford Taurus, Sable, T-Bird,  
Cougar and Continental  
1993 - 86

UNIT PACKAGE: 1

# FORD SOCKET ASSY. & HARNESS CONNECTORS

Sec. 12

Use with butt connectors on pages 142 - 149 • Illustrations Not Actual Size



**20550**

Not Supplied  
By O.E.M.

Multi-Function Switch  
Harness Connector  
Fits 13K359 Switches F1AZ-A, B,  
F1DZ-B, F1LY-B, F10Y-D,  
F1VY-C, F3TZ-B, F3UZ-C,  
F4ZZ-AA, F58Z-A, F5AZ-A,  
F5TZ-B, F65Z-AA, F6DZ-A,  
F75Z-AB,AC,BA, F77Z-AA,  
F79Z-CA & F85Z-AA  
Ford Aerostar, Bronco, Continental,  
Cougar, Expedition, Explorer,  
F Pick-Ups, Mark Series,  
Mountaineer, Mustang, Navigator,  
Ranger, Sable, T-Bird, Taurus, Town  
Car & Windstar  
1990 - On

UNIT PACKAGE: 1



**20246**

Not Supplied  
By O.E.M.

Multi-Function Switch  
Repair Harness  
Eleven 18 Ga. Leads  
Aerostar, E Van, Expedition,  
Mustang, Navigator, Sable,  
Taurus & Windstar  
1992 - On

UNIT PACKAGE: 1



**18673**

Not Supplied  
By O.E.M.

Multi-Function Switch  
(Turn Signal & Windshield Wiper)  
Harness Connector  
Fits Switch E9DZ-13K359-A, B, C,  
E8ZZ-13K359-B & F0ZZ-13K359-A  
Ford Mustang 1993-87  
Taurus & Sable 1989-86

UNIT PACKAGE: 1



**17623**

Not Supplied  
By O.E.M.

EEC IV Test Plug  
Repair Harness Connector  
Two Connectors With Eight  
18 Gauge Leads  
Ford 1983-On

UNIT PACKAGE: 1



**19581**

Not Supplied By O.E.M.

EEC IV Test Plug  
Repair Harness Connector  
One 18 Ga. Wire Lead  
Ford 1983-On

**19581 Is A Component Of  
Auveco 17623 Harness Connector**

UNIT PACKAGE: 5



**19881**

Not Available From  
O.E.M.

Ignition Switch  
Harness Connector  
Used With Switch D0TZ-11572A,  
SW944  
Ford Trucks: 100-900 Series  
1970-On

UNIT PACKAGE: 1



**20172**

Not Supplied  
By O.E.M.

EEC Relay  
Harness Connector  
Used With Relay E3AZ-12A646-A  
Two 18 Ga. Wire Leads, Two 16 Ga.  
Wire Leads & One 14 Ga. Wire lead  
Ford Cars & Trucks  
1981-On

UNIT PACKAGE: 1

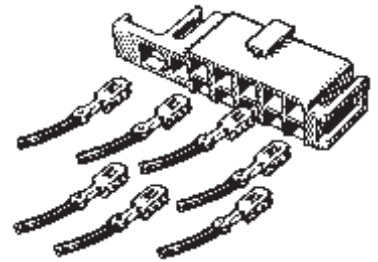

**17684**

Not Supplied  
By O.E.M.

Ignition Switch  
Harness Connector  
Fits Ignition Switch E6FZ-11572A  
Ford 1992-80

UNIT PACKAGE: 1



**18676**

(E6DZ-14A411-A)

Ignition Switch  
Harness Connector  
Fits Switch E7DZ-11572-A  
Ford Taurus, Sable & Lincoln  
Continental  
1986-On

UNIT PACKAGE: 1

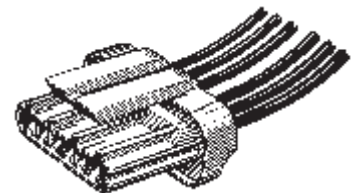

**18214**

Not Supplied  
By O.E.M.

Ignition Module  
Harness Connector  
Fits Ignition Module  
E8TZ-12A297A  
Ford Ranger: 1995-88

UNIT PACKAGE: 1

## Sec. 12

# FORD SOCKET ASSY. & HARNESS CONNECTORS

Use with butt connectors on pages 142 - 149 • Illustrations Not Actual Size

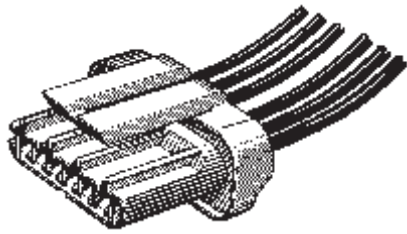

**18217**

(E5ZZ-12A209A)

Ignition Module &  
Neutral Safety Switch  
Harness Connector  
For E.E.C. IV Ignition  
1995-83

Ford Neutral Safety  
Switch E80Z-7A247-A  
1988-On

UNIT PACKAGE: 1

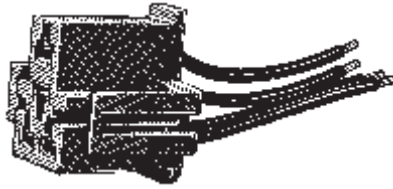

**17620**

Not Supplied  
By O.E.M.

Air Conditioning  
Blower Motor  
Resistor Assembly  
Harness Connector  
Fits Resistor Assembly  
E7TZ-19A706-A  
Ford Trucks 1983-On

UNIT PACKAGE: 1



**18675**

Not Supplied  
By O.E.M.

Air Conditioner Control  
Assembly Switch  
Harness Connector  
Fits Switch E83Z-19980-A, B  
Ford Tempo & Topaz  
1994-88

UNIT PACKAGE: 1



**19623**

Ignition Control Module Harness  
For Modules F1AZ, F4SZ-12072A  
& F5SZ-12072AA

Wire Gauge: 5 of 18 & 7 of 16  
8" Leads

Ford: Full Size Trucks &  
Vans, T-Bird, Cougar  
Lincoln Town & Mark  
1991-On

UNIT PACKAGE: 1



**18819**

Not Supplied  
By O.E.M.

Heater & Air Conditioner  
Blower Switches  
Harness Connector  
Fits Most Ford Switches  
With Base Number 19986  
1973-On

UNIT PACKAGE: 1



**19883**

Not Available From O.E.M.

Blower Motor Switch  
Harness Connector  
Used With Switch E83Z-19986A,  
YH-481  
Tempo & Topaz  
1994-88

UNIT PACKAGE: 1

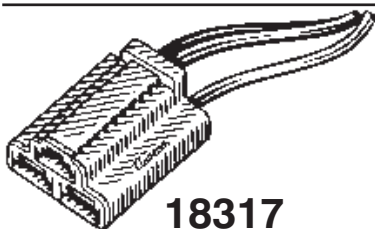

**18317**

Not Supplied  
By O.E.M.

Blower Motor  
Harness Connector  
Heavy Duty Applications  
12 Ga. Type GXL Wire  
GM, Ford & Chrysler

UNIT PACKAGE: 1

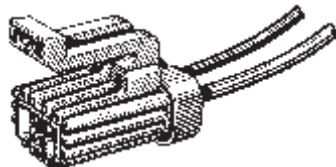

**19582**

Not Supplied  
By O.E.M.

Harness Connector  
For Heater Blower Motor  
& Radiator Cooling Fan Motor  
Ford Truck & Vans  
1986-82

Ford 4-Cyl. Eng. 1979-On  
**Replaces Auveco 18213**

UNIT PACKAGE: 5



**19887**

Not Available  
From O.E.M.

Auxiliary Blower Switch  
Harness Connector  
Fits Switch F2UZ-19986C, YH-538  
Ford Vans E150/350  
1992-On

UNIT PACKAGE: 1



# FORD SOCKET ASSY. & HARNESS CONNECTORS

**Sec. 12**

Use with butt connectors on pages 142 - 149 • Illustrations Not Actual Size

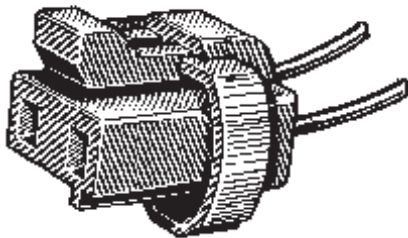

**17598**

Not Supplied  
By O.E.M.

Air Conditioning Clutch  
Cycling Pressure Switch  
Harness Connector  
Fits Switch E35Y-19E561-A  
Ford 1980-On

UNIT PACKAGE: 1

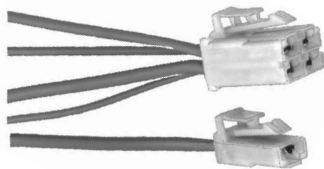

**19661**

Not Supplied By O.E.M.

Blower Motor Resistor  
Harness Connector  
Fits Resistors F1CZ-19A706-A  
& F7CZ-19A706-AA  
One Connector Had One Each Of  
8" Long 20 Ga., 16 Ga., 14 Ga. &  
12 Ga. GXL Wire Leads.  
The Other Connector Has  
One 8" Long 12" Ga. GXL Wire Lead.  
Ford Escort & Tracer  
1991-On

UNIT PACKAGE: 1



**17619**

(E4FZ-8C290-A)

Engine Cooling Fan  
Harness Connector Wiring Kit  
Ford 4 Cyl. (2.3 Eng.)  
With Air Conditioning  
1983-On

UNIT PACKAGE: 1

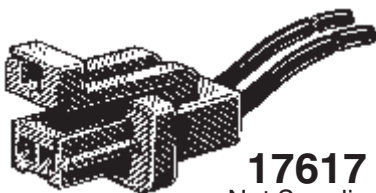

**17617**

Not Supplied  
By O.E.M.  
Gray

Engine Cooling Fan  
Motor Switch  
Harness Connector  
Fits Switch E43Z-8B607-A  
Ford 1984-On

UNIT PACKAGE: 1



**20277**

Not Supplied  
By O.E.M.

Heater/Air Cond.  
Fan Speed Switch  
Harness Connector  
Two 12 Ga., One 14 Ga.  
& One 16 Ga. Leads  
Fits Switches E6DZ-A, E9SZ-A,  
F2DZ-A & F2UZ-19986A,B  
Ford Cougar, E Van,  
Mustang, Sable, Taurus  
& T-Bird  
1986 - On

UNIT PACKAGE: 1

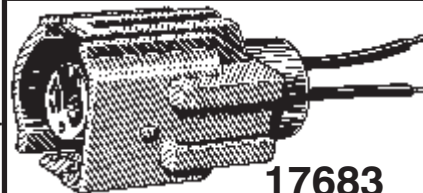

**17683**

Not Supplied  
By O.E.M.

Coolant Temperature Sensor  
Harness Connector  
Fits Sensor E1AZ-12A648A  
Ford 1981-On

UNIT PACKAGE: 1



**18216**

Not Supplied  
By O.E.M.  
Gray Shell

Exhaust Oxygen Sensor  
Harness Connector  
Fits Sensors F0TZ-9F472-A & C,  
F09Z-9F472-A & C,  
F1SZ-9F472-A & F1UZ-9F472-C  
Ford: 1995-89

UNIT PACKAGE: 1

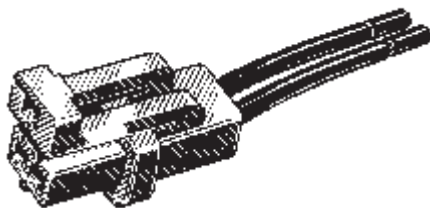

**17618**

Not Supplied  
By O.E.M.  
Black

Engine Cooling Fan  
Motor Switch  
Harness Connector  
Fits Switches E5SZ-8B607-A  
& E4FZ-8B607-A  
Ford 1984-On

UNIT PACKAGE: 1



**20549**

Not Supplied  
By O.E.M.

Radiator Cooling  
Fan Motor  
Harness Connector  
Fits Fan & Shroud Assemblies  
F4DZ-8C607B & F5CA-8C607A  
Ford Contour, Continental, Escort,  
Mystique, Sable & Taurus  
1997 - 90

UNIT PACKAGE: 1



**18215**

Not Supplied  
By O.E.M.  
Black Shell

Exhaust Oxygen Sensor  
Harness Connector  
Fits Sensors F0SZ-9F472-A & B,  
F0TZ-9F472-B & E, F02Z-9F472-C  
& F03Z-9F472-A  
Ford 1995-89

UNIT PACKAGE: 1

# Sec. 12

## FORD SOCKET ASSY. & HARNESS CONNECTORS

Use with butt connectors on pages 142 - 149 • Illustrations Not Actual Size



**19889**

Not Available From O.E.M.

Exhaust Oxygen Sensor  
Harness Connector  
Used With 3 Wire O2 Sensors  
(Base No. 9F472)  
Ford  
1986-On

UNIT PACKAGE: 1

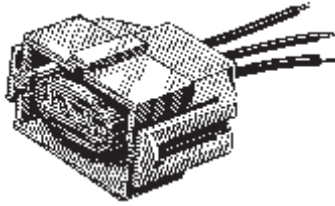

**17662**

Not Supplied  
By O.E.M.

EGR Sensor Harness Connector  
Fits Sensor E6AZ-9J460-A  
Ford Escort, Lynx, Sable & Taurus  
1988-On

UNIT PACKAGE: 1



**17622**

Not Supplied  
By O.E.M.

Fuel Pump  
Relay Assembly  
Harness Connector  
Fits Relay Assembly  
E3FZ-9345-B  
Ford 1983-On

UNIT PACKAGE: 1

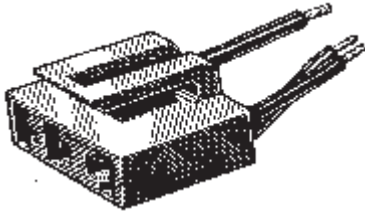

**17661**

Not Supplied  
by O.E.M.

Electronic Ignition Coil  
Harness Connector  
Fits Coil E73Z-12029A  
Ford 1986-On

UNIT PACKAGE: 1

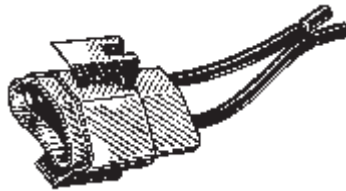

**17621**

Not Supplied  
By O.E.M.

Windshield Washer  
Pump Harness Connector  
Fits Pumps E0AZ-17664-A &  
E30Z-17664-A  
Ford 1968-On

UNIT PACKAGE: 1

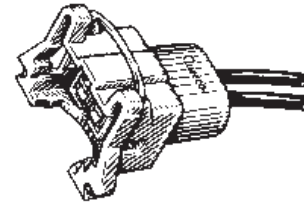

**16968**

(12085491)

Fuel Injector Solenoid Connector  
Pigtail  
Fits GM Multi-Port Fuel Injector  
1711799 on 2.8 and 3.1 liter engines  
(27 models) 1986-On  
Also fits Fuel Injectors on Ford,  
Chrysler & Imports (Bosch)

UNIT PACKAGE: 1



**19660**

Not Supplied  
By O.E.M.

Windshield Washer Pump  
Harness Connector  
Fits Washer Pumps  
E4TZ-17664-A, E5TZ-17664-B,  
F19Z-17664A & E6S3-17664-CA  
Two 8" Long 16 Ga. Wire Leads  
Ford  
1984-On

UNIT PACKAGE: 1



**18677**

Not Supplied  
By O.E.M.

Idle Air By-Pass Valve  
Harness Connector  
Fits Valves With Ford  
Base Part Number 9F715  
Ford

UNIT PACKAGE: 1

**Please Order In  
Unit Package  
Quantity  
Not Pieces**

# FORD SOCKET ASSY. & HARNESS CONNECTORS

Use with butt connectors on pages 142-149 • Illustrations Not Actual Size

**Sec. 12**



**18671**  
Not Supplied  
By O.E.M.

Air Conditioner  
Clutch Field Coil  
Harness Connector  
Ford

UNIT PACKAGE: 10



**19157**  
Not Supplied  
By O.E.M.

Variable Speed Sensor  
Harness Connector  
For Speed Sensors With  
Ford Base No. 9E731.  
Ford 1993-On

UNIT PACKAGE: 1



**20561**  
Not Available  
From O.E.M.

Brake Light Switch  
Harness Connector  
Fits Switches YF1Z-13480-AA  
& YF1Z-13480BA  
Ford, Lincoln & Mercury  
2000 - On  
Ford Explorer & Mercury  
Mountaineer  
1999 - 98

UNIT PACKAGE: 1



**19156**  
Not Supplied  
By O.E.M.

Alternator Regulator &  
Air Cond. Clutch Field  
Harness Connector  
Ford 1994-On

UNIT PACKAGE: 10



**19212**  
Not Supplied  
By O.E.M.

Inertia Fuel Shut-Off  
Switch Harness Connector  
Fits Switch F5AZ-9341-A  
Ford  
1988-On

UNIT PACKAGE: 1



**19880**  
Not Available  
From O.E.M.

Transmission Gear Shift  
Position Sensor Harness Connector  
Eight Wire Leads  
Used With Switch F5TZ-7A247 on  
Ford Trucks w/ E 4 OD Transmission,  
RWD 1989-84 and E, F & U Series  
1989-On

UNIT PACKAGE: 1



**19076**  
Not Supplied  
By O.E.M.

Master Cylinder,  
Door Jamb Switch  
& Power Mirror Harness Connector  
Ford 1987-On

UNIT PACKAGE: 1



**19813**  
(D1AZ-13410-A)

Power Brake  
Harness Connector  
Ford  
1965-On

UNIT PACKAGE: 10



**19004**  
(F2PZ-14A464C,  
F4UB-14A464A)

Transmission MLP Sensor  
Harness Connector  
E150/350, F250/350  
& U150 (Bronco)  
1990-On

UNIT PACKAGE: 1

**Sec. 12**

**FORD SOCKET ASSY. & HARNESS CONNECTORS**

Use with butt connectors on pages 142-149 • Illustrations Not Actual Size



**19885**

F4PZ-14A411C

Windshield Wiper Motor  
Harness Connector  
For New Single Connector  
Replacement Motors (6 Positions)  
Ford 1987-On

UNIT PACKAGE; 1

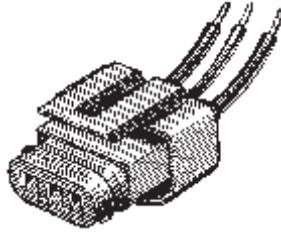

**17659**

Not Supplied  
By O.E.M.

Voltage Regulator Plug  
Harness Connector  
Sable, Taurus, Tempo & Topaz  
With Internal Voltage Regulator  
1986-On

UNIT PACKAGE: 1

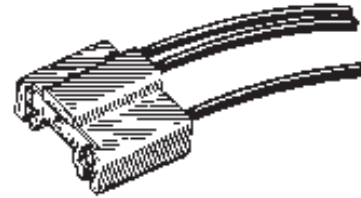

**11437**

Dimmer Switch  
Harness Connector  
Ford & Chrysler

UNIT PACKAGE: 10



**18668**

Not Supplied  
By O.E.M.

In-Tank Fuel Pump &  
Sending Unit Connector  
Ford 1985-On

UNIT PACKAGE: 5

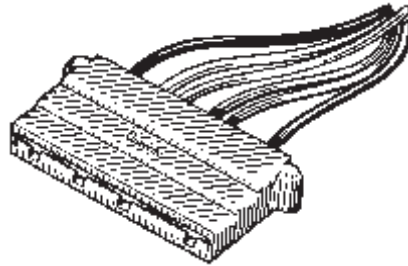

**11445**

Voltage Regulator  
Harness Connector  
Ford

UNIT PACKAGE: 10

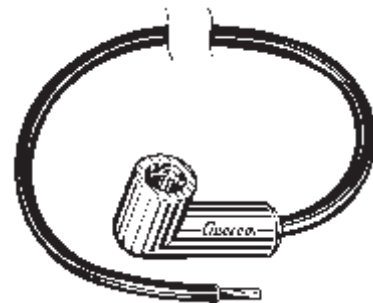

**13644**

Right Angle Pigtail  
General Purpose  
11-1/2" Wire Lead For .160 Stud  
Ford

UNIT PACKAGE: 10

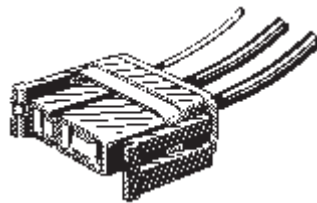

**18218**

Not Supplied  
By O.E.M.

Alternator Harness Connector  
Ford Aerostar, Tempo, Topaz, Taurus  
& Sable w/6 Cyl. Eng. & 75 Amp. Alt.  
1989-On

4 Cyl. Eng. 1985-On

UNIT PACKAGE: 1

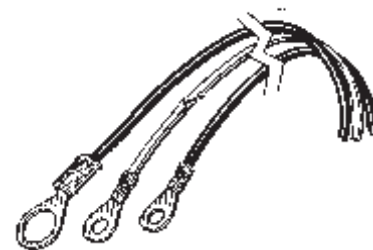

**13551**

Alternator Pigtail  
Repair Harness  
Ford

UNIT PACKAGE: 3

**You Can E-Mail Your  
New Item  
Suggestions To  
mail@auveco.com**

# CHRYSLER SOCKET ASSY. & HARNESS CONNECTORS

**Sec. 12**

Use with butt connectors on pages 142 - 149 • Illustrations Not Actual Size

**12237**

(Chrys: 3744750;  
GM: 12004311,  
25015169; Ford: C8OZ-13711A)



Instrument Panel Socket  
For 1/2" Hole  
Bulb No. 194  
GM, Ford & Chrysler  
UNIT PACKAGE: 2

**9905**

(Chrys: 2496279;  
GM: 2973932;  
AMC: 3509575;  
IHC: 374985C1)



Instrument Panel Socket  
For 5/8" Hole  
Bulb No. 194  
GM, Chrysler, AMC & International  
UNIT PACKAGE: 10

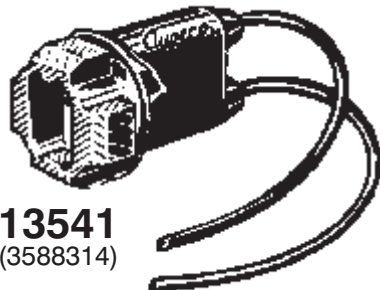

**13541**  
(3588314)

Side Marker Assembly  
Bulb Nos. 194, 194A  
Chrysler  
UNIT PACKAGE: 2

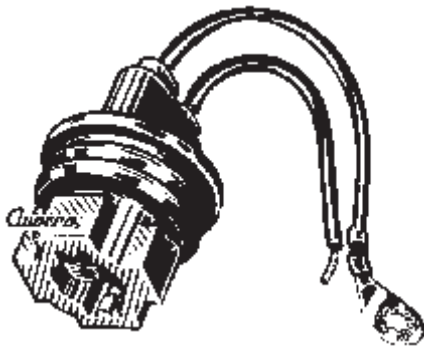

**13542**  
(3513686, 4055028)

Side Marker Assembly  
Bulb Nos. 194, 194A  
Chrysler  
UNIT PACKAGE: 2



**12598**

(3764865, 3843245,  
4124721, 4163003)

Single Contact With Ground  
Bulb Nos. 87, 93, 1073, 1141 & 1156  
Chrysler  
UNIT PACKAGE: 1

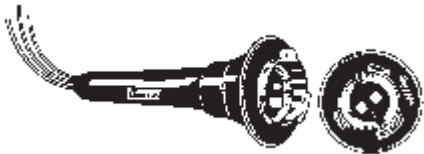

**12599**

(3764863)

Double Contact, With Ground  
Bulb Nos. 1034, 1154 & 1157  
Chrysler  
UNIT PACKAGE: 1



**13233**

(3843432)

Signal & Park Lights  
Bulb Nos. 198, 1016, 1034,  
1154 & 1157  
Chrysler  
UNIT PACKAGE: 1



**20389**

Not Available From O.E.M.  
Signal, Stop, Tail & Turn Lights  
Bulb No. 1157  
Chrysler Including Trucks  
1992 - 89  
UNIT PACKAGE: 1

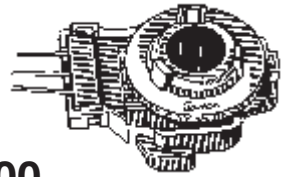

**12600**

(GM: 12003759;  
AMC: 812893)

90° Pigtail & Socket Assembly  
Bulb Nos. 1016, 1034, 1154 & 1157  
GM & AMC  
UNIT PACKAGE: 1



**18919**

(4636359)

Signal & Park Lights  
Chrysler 1984-On  
UNIT PACKAGE: 1



**18921**

(4636360)

Signal, Park & Back-Up Lights  
Chrysler 1993-88  
UNIT PACKAGE: 1



**18920**

(4636362)

Back-Up Lights  
Chrysler 1990-On  
UNIT PACKAGE: 1

## Sec. 12

### CHRYSLER SOCKET ASSY. & HARNESS CONNECTORS

Use with butt connectors on pages 142 - 149 • Illustrations Not Actual Size

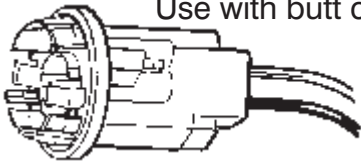

**11157**

(AMC: 4486948;  
GM: 8912698, 6299087)

Signal, Park, Stop & Tail Lights  
Bulb Nos. 1034, 1154 & 1157  
GM & AMC

UNIT PACKAGE: 1

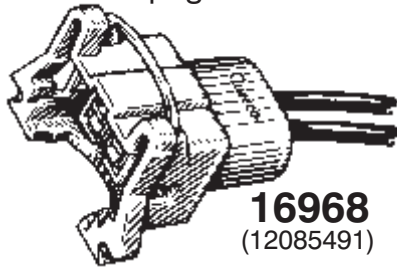

**16968**

(12085491)

Fuel Injector Solenoid  
Connector Pigtail  
Fits GM Multi-Port Fuel Injector  
1711799 on 2.8 and 3.1 liter engines  
(27 models) 1986-On  
Also fits Fuel Injectors on Ford,  
Chrysler & Imports (Bosch)

UNIT PACKAGE: 1

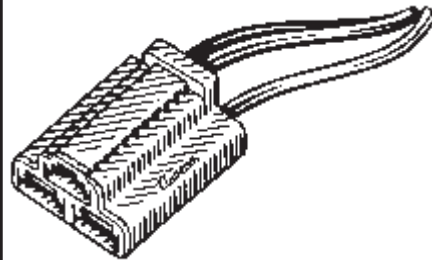

**11440**

(GM: 2962510)

Air Conditioner Blower  
Relay Harness Connector  
GM, AMC & Chrysler

UNIT PACKAGE: 10

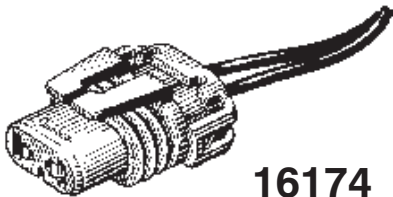

**16174**

Headlight Socket Assembly  
For Low Beam 9006 Halogen Bulb  
Single Indexing Groove  
GM, Ford, AMC & Imports

UNIT PACKAGE: 4



**11437**

Dimmer Switch Harness Connector  
Ford & Chrysler

UNIT PACKAGE: 10

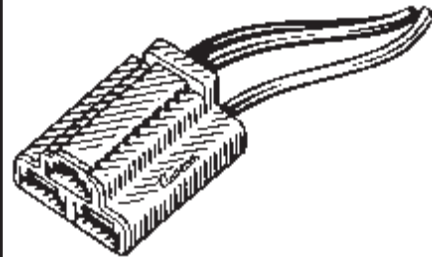

**18317**

Not Supplied By O.E.M.

Blower Motor Harness Connector  
Heavy Duty Applications 12 Ga.  
Type GXL Wire  
GM, Ford & Chrysler

UNIT PACKAGE: 1

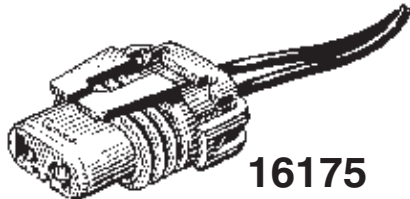

**16175**

Headlight Socket Assembly  
For High Beam 9005 Halogen Bulb  
Two Indexing Grooves  
GM, Ford, AMC & Imports

UNIT PACKAGE: 4

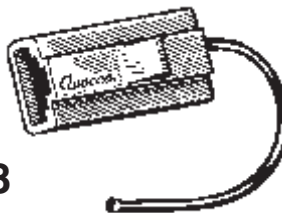

**11438**

Temperature Sending Unit  
Harness Connector  
GM  
Voltage Regulator  
Harness Connector  
Chrysler

UNIT PACKAGE: 10

### UNIVERSAL PIGTAIL SOCKET ASSEMBLIES & HARNESS CONNECTORS



**5219**

Pigtail Connector  
Single Small Wire Lead - 12" Long  
For Sockets Housing Miniature  
Lights

UNIT PACKAGE: 10



**5220**

Pigtail Connector  
Single Large Wire Lead - 12" Long  
For Sockets Housing  
Single Contact Lights

UNIT PACKAGE: 10



**5221**

Pigtail Connector  
Double Wire Lead - 12" Long  
Aligned Ears.  
For Sockets Housing Double  
Contact Lights

UNIT PACKAGE: 10

**UNIVERSAL SOCKET ASSY. & HARNESS CONNECTORS**

Use with butt connectors on pages 142 - 149 • Illustrations Not Actual Size



**8763**  
(13235-A)

Weatherproof Covered Neoprene Signal, Park, Stop & Tail Lights  
Bulb Nos. 198, 1016, 1034, 1154 & 1157

UNIT PACKAGE: 10

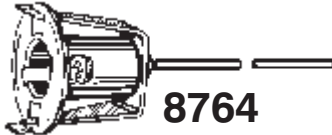

**8764**

Single Contact License Plate Lights  
Bulb Nos. 63, 67, 87, 89, 93, 97, 209, 1003, 1073, 1129, 1133, 1141 & 1156  
For 7/8"-1-1/8" Holes

UNIT PACKAGE: 5



**5226**

Universal Signal, Park, Stop & Tail Lights  
Bulb Nos. 198, 1016, 1034, 1154 & 1157  
For 7/8" to 1-1/8" Hole

UNIT PACKAGE: 10



**5227**

Universal Signal, Park, Stop & Tail Lights  
Bulb Nos. 64, 68, 82, 88, 90, 94, 210, 1004, 1076, 1130, 1142, 1158, 1176 & 1178  
For 7/8" to 1-1/8" Hole

UNIT PACKAGE: 10



**5225**

Pigtail Connector  
Three Wire Sealed Beam  
12" Long - Molded

UNIT PACKAGE: 10

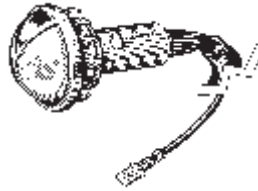

**13554**

Shielded License/Utility Light Sealed Socket Assembly w/ Chrome Plastic Shield  
14" Sealed Plastic Boot  
28" Lead w/Male Spade Terminal  
Bulb Included-Mounts in 1-1/4" Hole

UNIT PACKAGE: 1



**19151**

Shielded License/Utility Light Sealed Socket Assembly with Chrome & Plastic Shield  
12" Lead with Male Spade Terminal  
Bulb Included-Mounts in 1-1/4" Hole

UNIT PACKAGE: 1



**19005**

Fuel Injector Harness Connector  
For Lucas & Bosch Fuel Injectors  
Domestic & Import Vehicles

UNIT PACKAGE: 1

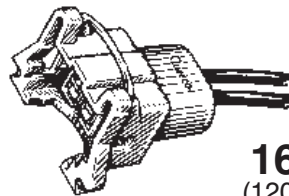

**16968**  
(12085491)

Fuel Injector Solenoid Connector Pigtail  
Fits GM Multi-Port Fuel Injector 1711799 on 2.8 and 3.1 liter engines (27 models) 1986-On  
Also fits Fuel Injector on Ford, Chrysler & Imports (Bosch)

UNIT PACKAGE: 1



**13559**

Headlight & Flasher  
For all Cars using 2 Prong Sealed Headlight Bulb No. 4001

UNIT PACKAGE: 3



**11439**

Headlight & Flasher  
For All Cars Using 3 Prong Sealed Headlight Bulbs 4002, 3, 5, 5040, 2, 5400, 2, 40, 421, 6006, 12 & 13.  
Also fits 2 & 3 Prong Flashers

UNIT PACKAGE: 10



**12751**  
(2973385)

Flasher Pigtail  
Wire Size 14 Gauge  
Wire Lead Length 6"  
All Purpose 2 Terminal Flashers  
Standard & H.D.

UNIT PACKAGE: 5

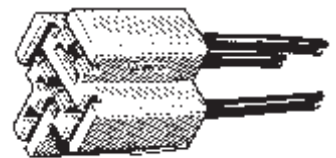

**16966**

Three terminal Flasher connector pigtail designed specifically for heavy duty thermal and electronic flashers with variable and fixed loads - single and alternating flash patterns. Features three 10" long 14 gauge GXL wire leads.

UNIT PACKAGE: 2

# Sec. 12 UNIVERSAL SOCKET ASSY. & HARNESS CONNECTORS

Use with butt connectors on pages 142 - 149 • Illustrations Not Actual Size



**9901**

Pigtail Connector  
Single Wire Lead, 16 Ga., 12" Long  
Receptacle for use wherever there is  
a junction of two or more wires; such  
as behind an instrument panel or in  
an engine compartment. Use  
w/Auveco No. 9900.

UNIT PACKAGE: 20



**9900**

Pigtail Connector  
Single Wire Lead, 16 Ga., 12" Long  
Snap plug for use wherever there is  
a junction of two or more wires; such  
as behind an instrument panel or in  
an engine compartment. Use  
w/Auveco No. 9901.

UNIT PACKAGE: 20



**8770**

2 Way Harness Connector  
7-1/2" Leads, 18 Ga.  
Automotive, Truck and Marine. Use  
where a double harness is required.  
Also used on Trailers and Farm  
Implements.

UNIT PACKAGE: 5



**8768**

3-Way Harness Connector  
7-1/2" Leads  
Color Coded Wire Automotive,  
Truck and Marine. Use where a Triple  
Harness is required.  
Use with Auveco No. 8769

UNIT PACKAGE: 5



**8769**

3-Way Harness Connector  
7-1/2" Leads  
Color Coded Wire Automotive, Truck  
and Marine. Use where a Triple  
Harness is required.  
Use with Auveco No. 8768

UNIT PACKAGE: 5



**10222**

4 Way Harness Connector  
12" Leads, 18 Ga.  
For: Automotive, Truck Trailer Marine  
and Farm Implement Use.  
Use With Auveco No. 10223

UNIT PACKAGE: 5



**10223**

4 Way Harness Connector  
12" Leads, 18 Ga.  
For: Automotive, Truck, Trailer,  
Marine and Farm Implement Use.  
Use w/ Auveco No. 10222

UNIT PACKAGE: 5



**10782**

4 Way Harness Connector  
48" Wire Leads, 18 Ga.  
For: Automotive, Truck, Trailer,  
Marine and  
Farm Implement Use  
Use w/ Auveco No. 10783

UNIT PACKAGE: 2



**10783**

4 Way Harness Connector.  
48" Wire Leads, 18 Ga.  
For: Automotive, Truck, Trailer,  
Marine and  
Farm Implement Use.  
Use w/ Auveco No. 10782

UNIT PACKAGE: 2

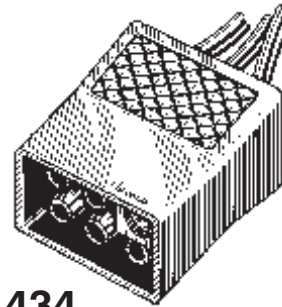

**11434**

Six Way Trailer Connector  
6 Color Coded Wire Leads  
(Male) For Trailer Application  
Use with Auveco No. 11435

UNIT PACKAGE: 5

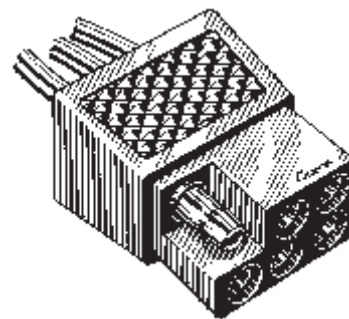

**11435**

Six Way Trailer Connector  
6 Color Coded Wire leads  
(Female) For Trailer Application  
Use with Auveco No. 11434

UNIT PACKAGE: 5



## UNIVERSAL SOCKET ASSY. & HARNESS CONNECTORS

**Sec. 12**

Use with butt connectors on pages 142 - 149 • Illustrations Not Actual Size



**13634**

Complete 4-Way Trailer Connector Polarized four prong. Chrome plated die cast housing. 2-hole flange mounting 1-13/16" on centers. Mounting bracket available.

UNIT PACKAGE: 1 Set

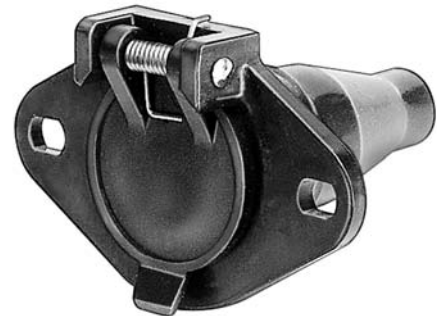

**13640**

6-Way Trailer Connector Socket

UNIT PACKAGE: 1



**13639**

6-Way Trailer Connector Plug

UNIT PACKAGE: 1



**13636**

Complete 6-Way Trailer Connector Assembly consists of 13639 plug and 13640 socket. Specifically designed for Recreational Vehicles. Die cast plug housing is chrome plated and socket is a one piece plastic molded unit complete with plated spring loaded cover and a special moisture and dust-proof boot.

UNIT PACKAGE: 1 Set

**Auveco Pak: The fastest moving, most popular automotive body hardware and specialty fastener items in a one-price bag. Refer to the color pages at the front of the catalog.**



**13643**

Universal Bracket  
For use with 13634 and 13640 electrical connectors. Designed to fit under trailer high ball. Heavy gauge zinc plated steel.

UNIT PACKAGE: 2

# Sec. 12

# MINIATURE BULBS

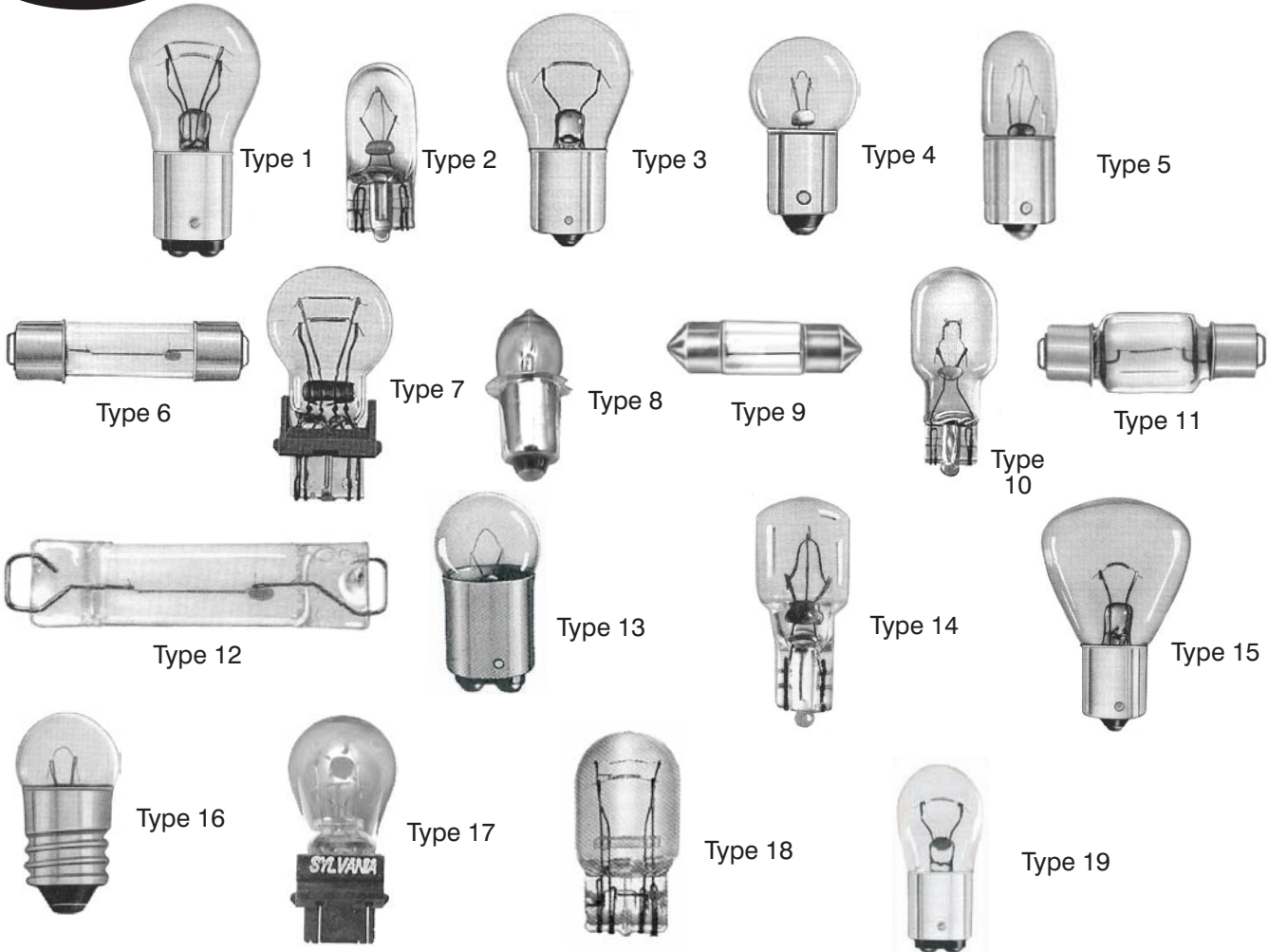

Auveco Part No.	Type	Replaces Bulb No.	Unit Pkg.	Auveco Part No.	Type	Replaces Bulb No.	Unit Pkg.	Auveco Part No.	Type	Replaces Bulb No.	Unit Pkg.
-----------------	------	-------------------	-----------	-----------------	------	-------------------	-----------	-----------------	------	-------------------	-----------

## Wagner Miniature Bulbs

16899	.....1	.....1157	.....10	16925	.....1	.....1034	.....10	18014	.....2	.....158	.....10
16901	.....1	.....1157NA	.....10	16926	.....3	.....93	.....10	18015	.....13	.....90	.....10
16902	.....2	.....194	.....10	16927	.....8	.....PR2	.....10	18016	.....2	.....74	.....10
16904	.....3	.....1156	.....10	17597	.....3	.....1156NA	.....10	18017	.....14	.....24	.....10
16905	.....4	.....67	.....10	17994	.....9	.....13050	.....10	18018	.....14	.....24NA	.....10
16906	.....4	.....1895	.....10	17995	.....9	.....12100	.....10	18465	.....2	.....37	.....10
16907	.....1	.....2057	.....10	17996	.....7	.....3156	.....10	18466	.....3	.....199	.....10
16908	.....1	.....2057NA	.....10	17997	.....7	.....3155	.....10	18467	.....4	.....293	.....10
16909	.....5	.....1893	.....10	17998	.....3	.....2396	.....10	18468	.....4	.....631	.....10
16910	.....4	.....57	.....10	17999	.....1	.....2357	.....10	18469	.....1	.....1076	.....10
16911	.....4	.....89	.....10	18000	.....1	.....2357NA	.....10	18470	.....4	.....1155	.....10
16912	.....4	.....97	.....10	18001	.....7	.....3157NA	.....10	18471	.....15	.....1195	.....10
16913	.....6	.....211-2	.....10	18002	.....5	.....1891	.....10	18472	.....4	.....1445	.....10
16914	.....4	.....53	.....10	18003	.....5	.....1889	.....10	18473	.....16	.....1449	.....10
16915	.....7	.....3057	.....10	18004	.....3	.....1073	.....10	18474	.....5	.....1815	.....10
16916	.....7	.....3057NA	.....10	18005	.....10	.....921	.....10	18475	.....7	.....3156NA	.....10
16917	.....7	.....3157	.....10	18006	.....10	.....916	.....10	18476	.....17	.....3157NA-SA	.....10
16918	.....3	.....1003	.....10	18007	.....10	.....916NA	.....10	18477	.....7	.....3357	.....10
16919	.....5	.....1816	.....10	18008	.....10	.....912	.....10	18478	.....7	.....3357NA	.....10
16920	.....19	.....1004	.....10	18009	.....11	.....577	.....10	18479	.....17	.....3157SA	.....10
16921	.....2	.....168	.....10	18010	.....12	.....561	.....10	19206	.....18	.....7440	.....2
16922	.....10	.....906	.....10	18011	.....6	.....212-2	.....10	19207	.....18	.....7443	.....2
16923	.....3	.....1141	.....10	18012	.....2	.....194NA	.....10	19208	.....3	.....1295NA	.....10
16924	.....1	.....198	.....10	18013	.....2	.....193	.....10				

**MINIATURE BULBS**

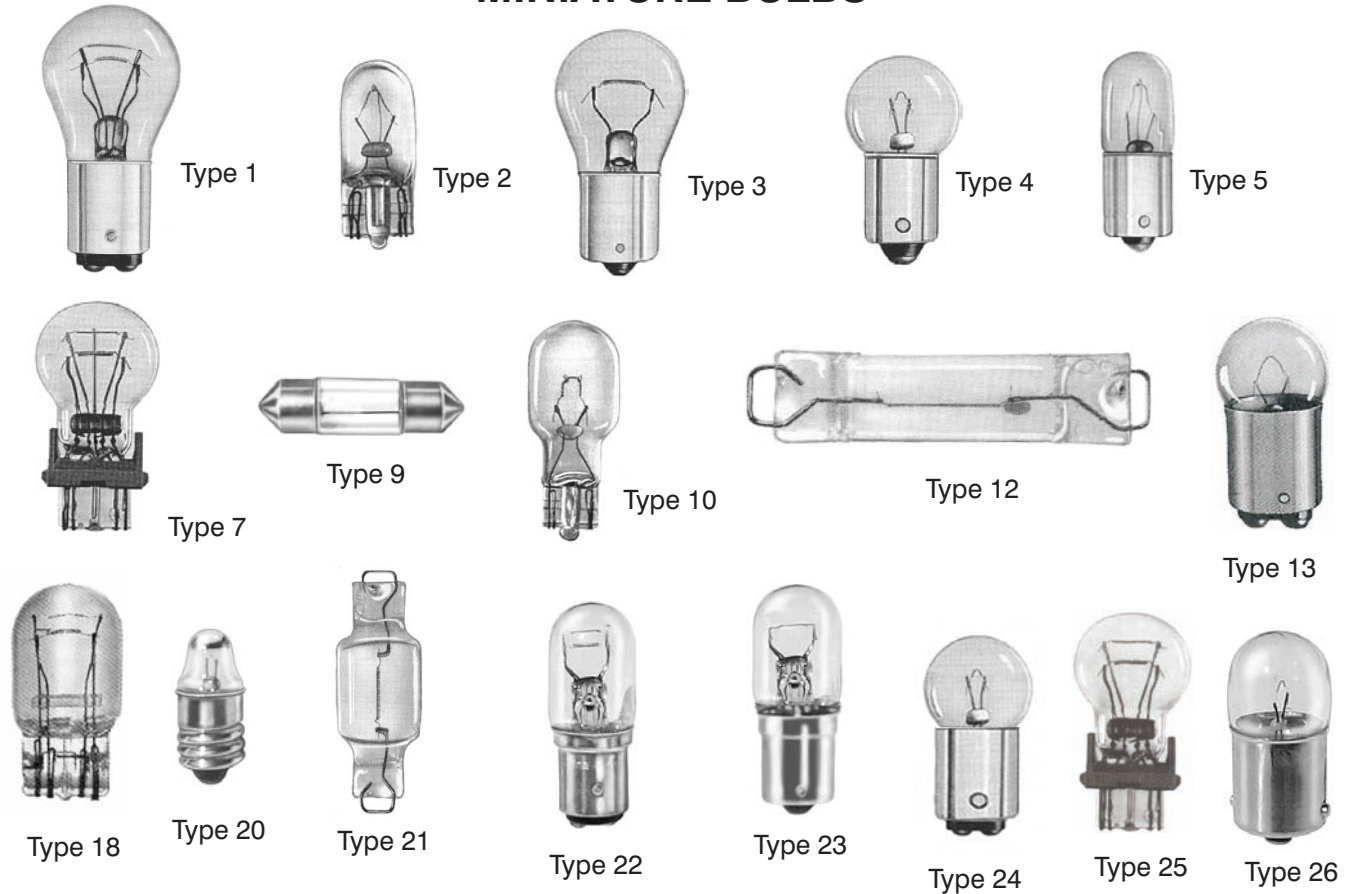

Auveco Part No.	Type	Replaces Bulb No.	Unit Pkg.	Auveco Part No.	Type	Replaces Bulb No.	Unit Pkg.	Auveco Part No.	Type	Replaces Bulb No.	Unit Pkg.
-----------------	------	-------------------	-----------	-----------------	------	-------------------	-----------	-----------------	------	-------------------	-----------

**Wagner Miniature Bulbs**

20282	.....4	.....55	.....10	20293	.....10	.....917	.....10	20587	.....25	.....3457	.....10
20283	.....4	.....63	.....10	20294	.....10	.....922	.....10	20588	.....25	.....3457NA	.....10
20284	.....2	.....73	.....10	20295	.....1	.....1638	.....10	20589	.....5	.....17131	.....10
20285	.....18	.....161	.....10	20296	.....22	.....3496	.....10	20590	.....26	.....17171	.....10
20286	.....18	.....192	.....10	20297	.....23	.....3497	.....10	20591	.....2	.....17177	.....10
20287	.....20	.....222	.....10	20298	.....18	.....3652	.....10	20592	.....3	.....17635	.....10
20288	.....18	.....558	.....10	20299	.....9	.....11005	.....10	20593	.....1	.....17916	.....10
20289	.....12	.....562	.....10	20300	.....9	.....11006	.....10	20620	.....7	.....4157LL	.....2
20290	.....21	.....570	.....10	20585	.....1	.....1176	.....10	20621	.....7	.....4157NALL	.....2
20291	.....10	.....904	.....10	20586	.....24	.....1178	.....10	20681	.....1	.....1142	.....10
20292	.....13	.....68	.....10								

A -Amber (Darker)  
 LL - Long Life  
 NA -Natural Amber (Lighter)  
 SA - Special Application

**Sec. 12**

**WAGNER HALOGEN LIGHT BULBS**  
Illustrations Are Not Actual Size



**16896**

9004/HB1 Bulb  
High-Low Beam  
In Single Headlight Assemblies  
12-18 Volts, 25-65 Watts  
Use With Auveco Socket 14918

UNIT PACKAGE: 1



**20682**

9005LL/HB3 Bulb

UNIT PACKAGE: 1



**20595**

881 Bulb

UNIT PACKAGE: 1



**18662**

9007/HB5 Bulb  
High-Low Beam  
12.8 Volts,  
55-65 Watts  
Use With Auveco  
Socket 14918

UNIT PACKAGE: 1

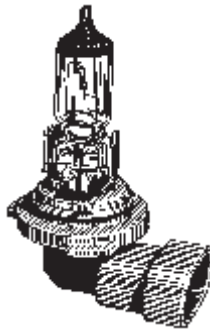

**16898**

9006/HB4 Bulb  
Low Beam  
In Dual Headlight Assemblies  
12.8 Volts, 55 Watts  
Use With Auveco Socket 16174

UNIT PACKAGE: 1



**20597**

889 Bulb

UNIT PACKAGE: 1

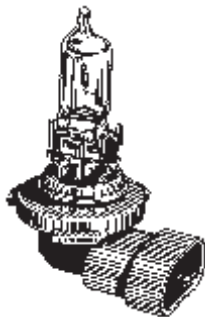

**16897**

9005/HB3 Bulb  
High Beam  
In Dual Headlight Assemblies  
12.8 Volts, 65 Watts  
Use With Auveco Socket 16175

UNIT PACKAGE: 1



**20683**

886 Bulb

UNIT PACKAGE: 1



**20684**

894 Bulb

UNIT PACKAGE: 1

**WAGNER HALOGEN LIGHT BULBS**

Illustrations Are Not Actual Size

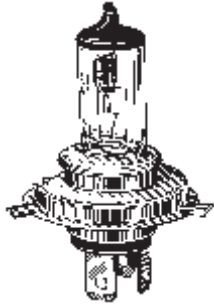

**18661**

9003/HB2 Bulb  
High-Low Beam  
12.0 Volts,  
55-60 Watts  
Use With Auveco  
Socket 5225

UNIT PACKAGE: 1



**20596**

885 Bulb

UNIT PACKAGE: 1



**20598**

891 Bulb

UNIT PACKAGE: 1



**20601**

1260/H4 Bulb

UNIT PACKAGE: 1



**20599**

893 Bulb

UNIT PACKAGE: 1



**20600**

1255/H3 Bulb

UNIT PACKAGE: 1



**20594**

880 Bulb

UNIT PACKAGE: 1



**19209**

2040 Bulb  
Center Grille  
Mercury  
Sable and Villager

UNIT PACKAGE: 1

**Please Order In  
Unit Package  
Quantity  
Not Pieces**

**BULB NUMBER TO AUVECO'S WAGNER BULB PART NUMBER**

Bulb No.	Auveco No.	Bulb No.	Auveco No.	Bulb No.	Auveco No.
PR2.....	16927	904.....	20291	3155.....	17997
24.....	18017	906.....	16922	3156.....	17996
24NA.....	18018	912.....	18008	3156NA.....	18475
37.....	18465	916.....	18006	3157.....	16917
53.....	16914	916NA.....	18007	3157NA.....	18001
55.....	20282	917.....	20293	3157NA-SA.....	18476
57.....	16910	921.....	18005	3157SA.....	18479
63.....	20283	922.....	20294	3357.....	18477
67.....	16905	1003.....	16918	3357NA.....	18478
68.....	20292	1004.....	16920	3457.....	20587
73.....	20284	1034.....	16925	3457NA.....	20588
74.....	18016	1073.....	18004	3496.....	20296
89.....	16911	1076.....	18469	3497.....	20297
90.....	18015	1141.....	16923	3652.....	20298
93.....	16926	1142.....	20681	4157LL.....	20620
97.....	16912	1155.....	18470	4157NALL.....	20621
158.....	18014	1156.....	16904	7440.....	19206
161.....	20285	1156NA.....	17597	7443.....	19207
168.....	16921	1157.....	16899	9003/HB2.....	18661
192.....	20286	1157NA.....	16901	9004/HB1.....	16896
193.....	18013	1176.....	20585	9005/HB3.....	16897
194.....	16902	1178.....	20586	9005LL/HB3.....	20682
194NA.....	18012	1195.....	18471	9006/HB4.....	16898
198.....	16924	1255/H3.....	20600	9007/HB5.....	18662
199.....	18466	1260/H4.....	20601	11005.....	20299
211-2.....	16913	1295NA.....	19208	11006.....	20300
212-2.....	18011	1445.....	18472	12100.....	17995
222.....	20287	1449.....	18473	13050.....	17994
293.....	18467	1638.....	20295	17131.....	20589
558.....	20288	1815.....	18474	17171.....	20590
561.....	18010	1816.....	16919	17177.....	20591
562.....	20289	1889.....	18003	17635.....	20592
570.....	20290	1891.....	18002	17916.....	20593
577.....	18009	1893.....	16909		
631.....	18468	1895.....	16906		
880.....	20594	2040.....	19209		
881.....	20595	2057.....	16907		
885.....	20596	2057NA.....	16908		
886.....	20683	2357.....	17999		
889.....	20597	2357NA.....	18000		
891.....	20598	2396.....	17998		
893.....	20599	3057.....	16915		
894.....	20684	3057NA.....	16916		

***Auveco Pak: The fastest moving,  
most popular automotive body hardware  
and specialty fastener items in a one-price bag.***

***Refer to the color pages at the  
front of the catalog.***

# PREMIUM IMPORTED MINIATURE BULBS

**Sec. 12**

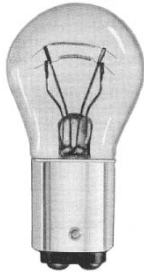

Type 1



Type 2



Type 3



Type 4



Type 5



Type 6

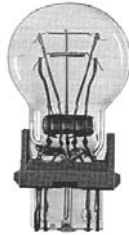

Type 7



Type 10



Type 14



Type 18



Type 22



Type 23



Type 25

Auveco Part No.	Type	Replaces Bulb No.	Unit Pkg.	Auveco Part No.	Type	Replaces Bulb No.	Unit Pkg.	Auveco Part No.	Type	Replaces Bulb No.	Unit Pkg.
-----------------	------	-------------------	-----------	-----------------	------	-------------------	-----------	-----------------	------	-------------------	-----------

## PREMIUM IMPORTED MINIATURE BULBS

19608	.....3	.....1156	.....10	20709	.....10	.....906	.....10	20722	.....7	.....3057	.....10
19609	.....1	.....1157	.....10	20710	.....10	.....912	.....10	20723	.....7	.....3057NA	.....10
19610	.....1	.....1157NA	.....10	20711	.....10	.....916	.....10	20724	.....7	.....3156	.....10
19611	.....2	.....194	.....10	20712	.....10	.....916NA	.....10	20725	.....7	.....3156NA	.....10
19612	.....2	.....194NA	.....10	20713	.....10	.....921	.....10	20726	.....7	.....3157	.....10
20701	.....14	.....24	.....10	20714	.....3	.....1156NA	.....10	20727	.....7	.....3157NA	.....10
20702	.....14	.....24NA	.....10	20715	.....5	.....1893	.....10	20728	.....25	.....3457	.....10
20703	.....4	.....57	.....10	20716	.....4	.....1895	.....10	20729	.....25	.....3457NA	.....10
20704	.....4	.....67	.....10	20718	.....1	.....2057	.....10	20730	.....22	.....3496	.....10
20705	.....4	.....89	.....10	20719	.....1	.....2057NA	.....10	20731	.....23	.....3497	.....10
20706	.....2	.....168	.....10	20720	.....1	.....2357	.....10	20732	.....18	.....7440	.....10
20707	.....6	.....211-2	.....10	20721	.....1	.....2357NA	.....10	20733	.....18	.....7443	.....10

NA - Natural Amber (Lighter)



**20717**

2040 Bulb  
Center Grille  
Mercury  
Sable and Villager

UNIT PACKAGE: 1



**20708**

891 Bulb

UNIT PACKAGE: 1

**BULB NUMBER TO AUVECO'S PREMIUM IMPORTED BULB  
PART NUMBER**

Bulb No.	Auveco No.	Bulb No.	Auveco No.	Bulb No.	Auveco No.
24 .....	20701	916NA .....	20712	3057 .....	20722
24NA .....	20702	921 .....	20713	3057NA .....	20723
57 .....	20703	1156 .....	19608	3156 .....	20724
67 .....	20704	1156NA .....	20714	3156NA .....	20725
89 .....	20705	1157 .....	19609	3157 .....	20726
168 .....	20706	1157NA .....	19610	3157NA .....	20727
194 .....	19611	1893 .....	20715	3457 .....	20728
194NA .....	19612	1895 .....	20716	3457NA .....	20729
211-2 .....	20707	2040 .....	20717	3496 .....	20730
891 .....	20708	2057 .....	20718	3497 .....	20731
906 .....	20709	2057NA .....	20719	7440 .....	20732
912 .....	20710	2357 .....	20720	7443 .....	20733
916 .....	20711	2357NA .....	20721		



**PUSH BUTTON SWITCHES**  
Heavy Duty Construction

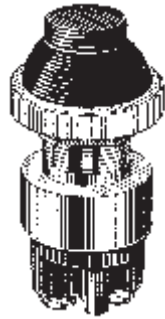

Rubber  
Boot

5/8"-32  
Threaded Mounting Stem

Auveco Part No.	12 Volt Rating	Boot	Unit Pkg.
12761	50 Amp	Yes	1

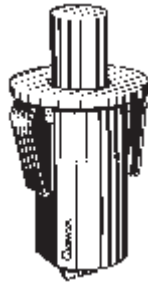

**13435**

(C3AZ-13713A, BOA-13713, OA-13713, B9MF-13713A)

Door Jamb Switch  
Ford Products Insulated Type  
2 Snap in Terminals

UNIT PACKAGE: 1

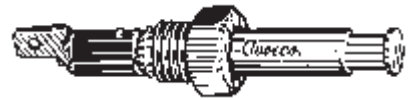

**13437**

(9839085,  
9662505,  
20057138)

Door Jamb Switch  
3/8"-24 x 2-3/16" Long  
Self-grounding

UNIT PACKAGE: 2



**13438**

(C8AB-13713A, C8AZ-13713A, C8OZ-13713A, C9AZ-13713A, C9MY-13713A, C9OB-13713A, C9O2-13713A, D1AB-13713A, C8AZ-13713B, D1AZ-13713C)

Door Jamb Switch  
Fits Into 7/8" Hole  
Ford

UNIT PACKAGE: 1

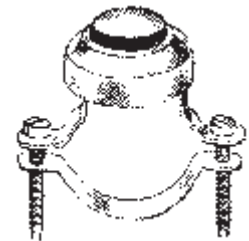

**12078**

Horn Button

UNIT PACKAGE: 1

**PUSH-PULL SWITCHES**

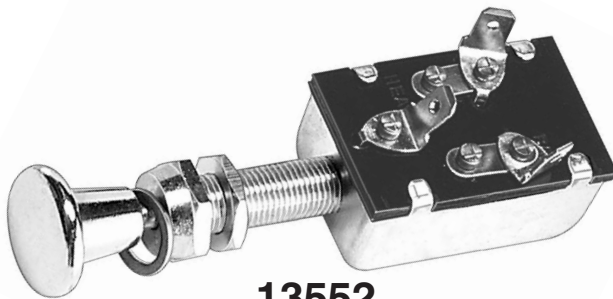

**13552**

Marine Switch  
3 Position "Off-On-On"

First 'On' position energizes one circuit. In second "On" position both circuits are energized. Mounting stem 1-1/4" long. 3/8" diameter. Brass hex back-up nut, brass washer, chrome plated brass face nut and chrome plated knob.  
15 Amps @ 12 Volts

UNIT PACKAGE: 1

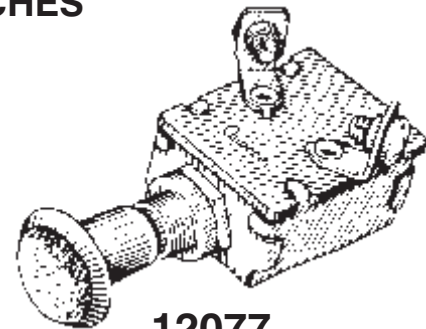

**12077**

Push-Pull Switch  
Heavy duty. 2 position "Off-On"  
switch w/2 Screw Terminals.

25 Amps @ 6 Volts  
15 Amps @ 12 Volts

UNIT PACKAGE: 1

# Sec. 12

## TOGGLE & ROCKER SWITCHES



### 13555

Toggle Switch  
 Rating: 35 Amps @ 6 Volts  
 20 Amps @ 12 Volts  
 S.P. S.T. "Off-On". All brass  
 Furnished with nickel plated brass  
 face nut and brass back-up nut.  
 Mounting stem 3/8" long. 7/16"  
 diameter with 7/16" x 28 threads.

UNIT PACKAGE: 1



Illuminated  
 Toggle Switches

2 Position "Off-On". Handle  
 illuminated in 'On' position. With  
 bezel nut and back-up collar for  
 mounting in 1/2" hole.  
 Rating: 20 Amps @ 12 Volts

Part No. Color

- 13523** Red illuminated toggle
- 13524** Green illuminated toggle
- 12236** Amber illuminated toggle
- 13525** Blue illuminated toggle

UNIT PACKAGE: 1

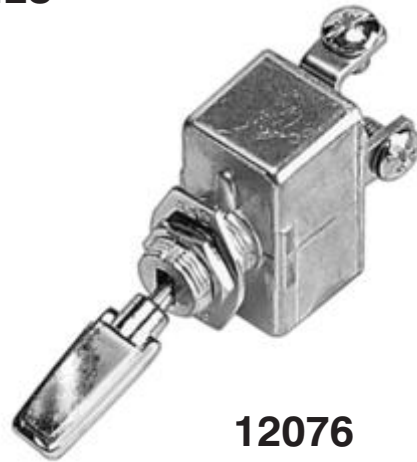

### 12076

Toggle Switch  
 Heavy Duty 2 position "On-Off"  
 For 35 Amp. 6-12 Volt DC. 15/32"  
 Stem Diameter. Low Voltage -High  
 Amp Application. Chrome Plated  
 Handle.

UNIT PACKAGE: 1



### 13556

Toggle Switch  
 2 positions "On-Off"  
 For lights, blower, pump, etc.  
 Black plastic paddle and locking  
 ring with level seal and knurled cap  
 nut. Sealed to resist water  
 penetration. Fits panels up to 1/4"  
 thick; requires 15/32" mounting  
 hole. Rated 20 Amps @ 12 Volts  
 D.C. and has 1/4" spade terminals

UNIT PACKAGE: 1



### 13514

S.P. D.T. Toggle Switch  
 "On-Off-On" Heavy Duty 3 Position  
 With 3 blade terminals. Black  
 molded. Bat handle. Spring  
 loaded for positive snap action.  
 Includes bezel nut and collar. Fits  
 in 1/2" diameter hole.  
 Rated: 16 Amps @ 12 Volts.

UNIT PACKAGE: 1



Terminal Coding:  
 1 -Accessory  
 2 -Ground  
 3 -Power

Illuminated rocker switches  
 2 Position "Off-On". Rocker  
 illuminated in 'On' position. Snaps  
 into 1-1/8" x 7/16" rectangular hole.  
 10 Amps. @ 12 Volts

Auveco  
 Part No. Color

- 12234** Red illuminated rocker
- 13529** Green illuminated rocker
- 13530** Amber illuminated rocker
- 13531** Blue illuminated rocker

UNIT PACKAGE: 1



### 13557

Toggle Switch  
 3 position "On-Off-On"  
 For running and anchor lights,  
 wipers, manual/auto bilge pumps  
 and dual fuel tanks. 20 amps  
 @ 12 Volts

UNIT PACKAGE: 1



### 12070

Toggle Switch  
 2 position w/2 Screw Terminals  
 Rating: 3 Amps. @ 250 Volts AC  
 6 Amps. @ 125 Volts AC

UNIT PACKAGE: 1



### 13528

Non-illuminated rocker switch  
 2 position "Off-On". Fits 1-1/8" x  
 7/16" rectangular hole. Rated 10  
 Amps @ 12 Volts.

UNIT PACKAGE: 1

# TOGGLE SWITCHES

# Sec. 12

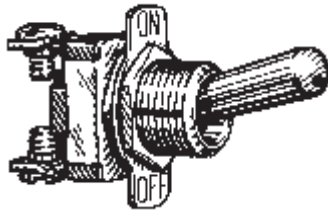

## 13630

S.P. S.T. Toggle Switch - "Off-On"  
 Phenolic housing. Mounting stem 15/32" long  
 15/32" diameter. 2 screw terminals. Bat handle  
 Rating: 15 Amps 125 Volts AC  
 10 Amps 250 Volts AC  
 3/4 HP 120-240 Volts AC

UNIT PACKAGE: 1

## 13632

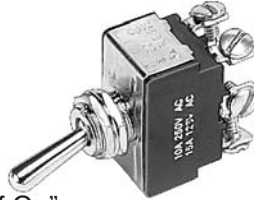

D.P. D.T. Toggle Switch - "On-Off-On"  
 Phenolic housing. Mounting stem 15/32" long.  
 15/32" diameter. 6 screw terminals  
 Rating: 15 Amps 125 Volts AC  
 10 Amps 250 Volts AC  
 3/4 HP 120-240 Volts AC

UNIT PACKAGE: 1

## 13631

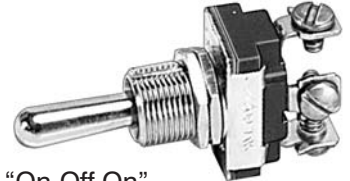

S.P. D.T. Toggle Switch - "On-Off-On"  
 Phenolic housing. Mounting stem 15/32" long.  
 15/32" diameter. 3 screw terminals. Bat handle.  
 Rating: 15 Amps 125 Volts AC  
 10 Amps 250 Volts AC  
 3/4 HP 120-240 Volts AC

UNIT PACKAGE: 1

## 12233



Illuminated Toggle Switch Mounting  
 Panel for use with Auveco Part No.  
 12234, 13529, 13530 & 13531.  
 1-1/8" x 7/16" Rectangular Hole.

UNIT PACKAGE: 1

## 12235



Illuminated toggle mounting panel  
 1/2" Hole Diameter

UNIT PACKAGE: 1



Indicator Lamps  
 Has wire leads for easy installation.  
 Mounts into 1/2" hole. 12 Volt  
 application.

Installs in Auveco Mounting  
 Panel 12235

Auveco Part No.	Color
20477	With Red Lens
13520	With Green Lens
13521	With Amber Lens
13522	With Blue Lens

UNIT PACKAGE: 1



## 12074

2 Position  
 Toggle Switch w/Red 12 Volt Pilot  
 Light On Mounting Plate  
 Each Toggle has 2 Blade Terminals  
 Rated 10 Amps @ 12 Volts

UNIT PACKAGE: 1

## 13629

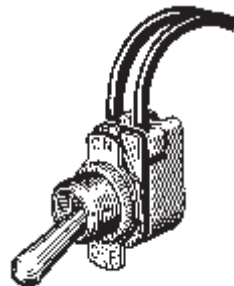

S.P. S.T. Toggle Switch - "Off-On"  
 Two 6" Wire Leads. With nickle  
 plated "Off-On" indicator plate  
 assembled. Mounting stem 15/32"  
 long. 15/32" diameter. Bat handle.  
 Rating: 6 Amps 125 Volts AC  
 3 Amps 250 Volts AC

UNIT PACKAGE: 1

**Sec. 13**

**WIRE LOOM CLIPS**  
(ILLUSTRATIONS ACTUAL SIZE)

**Vinyl (PVC) Cushion  
Clips Are Recommended  
For Underhood Or  
High Heat Applications**



**18161**  
Phosphate

Wire Loom Clips  
With Vinyl (PVC) Cushion  
Truck Body Frame

UNIT PACKAGE: 25



**18160**  
Phosphate

Wire Loom Clips  
With Vinyl (PVC) Cushion  
Truck Body Frame

UNIT PACKAGE: 25



**18162**  
Phosphate  
Wire Loom Clips  
With Vinyl (PVC) Cushion  
Truck Body Frame

UNIT PACKAGE: 25



**18159**  
Phosphate

Wire Loom Clips  
With Vinyl (PVC) Cushion  
Truck Body Frame

UNIT PACKAGE: 25



**2382**

Wire Loom Clips  
Clamps two 3/16" wires

UNIT PACKAGE: 100



**1340**

Wire Loom Clips  
1/4" Clamping Dia.

UNIT PACKAGE: 100



**1341**

Wire Loom Clips  
3/16" Clamping Dia.

UNIT PACKAGE: 100



**3758**

Wire Loom Clips  
3/8" Clamping Dia.

UNIT PACKAGE: 100



**2306**

Wire Loom Clips  
All Cars - All Models

UNIT PACKAGE: 100



**14388**  
(145525)

Heavy Duty Frame Wiring Clip  
3/16" Clamping Diameter  
Fits panels from .030"-.230"

UNIT PACKAGE: 50

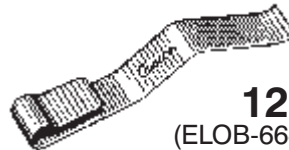

**12229**  
(ELOB-66454A30-AA)

Wire Harness Retainer Clip  
Ford 1980-On

UNIT PACKAGE: 25



**3759**

Wire Loom Clips  
All Cars - All Models

UNIT PACKAGE: 50

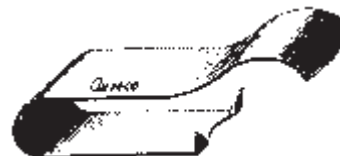

**9864**  
(372741-S100)  
General Purpose Wire Loom Clip

UNIT PACKAGE: 100



**9865**  
(373415)

General Purpose Wire Loom Clip

UNIT PACKAGE: 100



## Nylon Cable Clamps

Auveco Part No.	Cable Size	Screw Size	Unit Pkg.
<b>13939</b>	3/16"	#8-10	50
<b>13940</b>	1/4"	#8-10	50
<b>13941</b>	5/16"	#8-10	50
<b>13944</b>	1/2"	#8-10	50

## Nylon Tubing & Hose Clamps Adhesive Backed



Auveco Part No.	Range	Unit Pkg.
<b>10057</b>	.....5/32" to 1/4" .....	10
<b>10058</b>	.....5/16" to 1/2" .....	10
<b>10059</b>	.....9/16" to 3/4" .....	10



## 13937

Nylon Spring Clip

Width: 3/8"  
Overall Length: 1-5/16"  
Thickness: .060  
Use w/#8 Screw

UNIT PACKAGE: 50

## Cable Clips For Co-Ax Cable

Polyethylene clips with corrosion resistant galvanized steel nail.

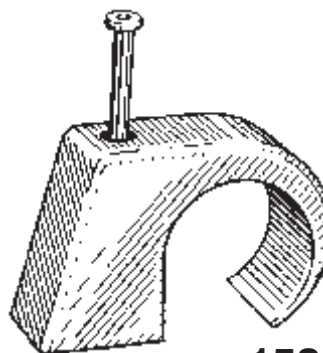

## 15854

3/16"-9/32" Cable Dia.  
Nail Length: 1"

UNIT PACKAGE: 50

## Strain-Relief Cable Connector

Reliable, liquid-tight, nylon strain-relief cable connector for quick and easy installation. They do not have to be disassembled before using. Simply insert a cable into the connector, tighten the cap nut and the cable is automatically fixed, centered, sealed and strain relieved.

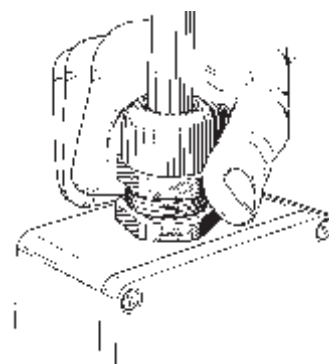
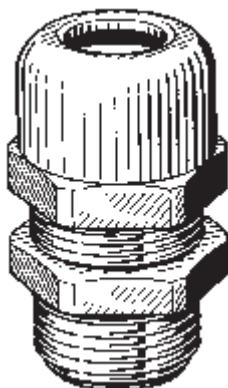

Auveco Part No.	Wire Dia.	Thread	Thread Length (Bottom)	Hex	Unit Pkg.
<b>15851</b>	.236" - .472"	1/2" NPT	.512"	.945"	5

# Sec. 13

## ROUTING CLIPS Wire Loom Routing Clips

Black Nylon routing clips for wire loom (also called split flexible tubing, convoluted conduit or wiring harness).



Type 1



Type 2



Type 3



Type 4



Type 5



Type 6



Type 7

Auveco Part No.	Type	For Conduit Size.		GM No.	Unit Pkg.
		I.D.	O.D.		
19440	3	1/4"	3/8"	12040984	15
19795	4	1/4"	3/8"	12015631	15
14544	1	11/32"	1/2"	8911473	25
20397*	6	10mm	13mm	12160858	15
20471	4	10mm	13mm	8905794	15
14545	1	13/32"	19/32"	8911497	25
14546	1	1/2"	11/16"	8911472	25
19851	5	1/2"	11/16"	12040983	15
14547	1	3/4"	1"	3816659, 8917320	25
20665	7	19mm	24mm	12160374	15
16941	2	1"	1-9/32"	12015983	25

\*Gray Nylon

## Routing Clips

A quick, economical method of fastening wires, tubes, hoses or rods from 1/4" to 1" diameter to metal, plastic or any other surface ranging from 1/32" to 1/8" thickness. Clips are molded of durable black nylon plastic. They snap into 1/4" diameter holes and are held firmly in place by flexible "snubber tips" which compensate for variation in wall thickness.



Auveco Part No.	Tube/Hose/Wire Outside Diameter	Clip Overall Height	Clip Height Above Panel	Unit Pkg.
14529	1/4"	27/32"	7/16"	25
14530	3/8"	29/32"	15/32"	25
14531	1/2"	1-1/16"	5/8"	25
14532	5/8"	1-3/16"	3/4"	25
14533	3/4"	1-5/16"	7/8"	25
14534	1"	1-19/32"	1-5/32"	25

# HARNESS STRAPS

**Sec. 13**



**5879**

Wiring Harness Strap  
5" Long, Natural Nylon  
UNIT PACKAGE: 25

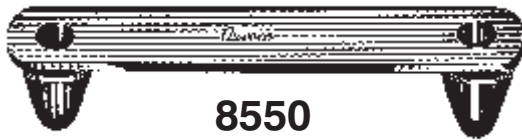

**8550**

Wire Loom Horn & Battery Fastener  
2-1/4" Long, Black Nylon  
UNIT PACKAGE: 25



**3690**

Windshield Washer & Cable to Headlamp and Voltage Regulator  
Strap  
3-1/2" Long, Natural Nylon  
UNIT PACKAGE: 100



**8272**

2-3/4" Long  
For 1/4" Hole  
In .093" Thick Metal  
Black Nylon  
UNIT PKG: 50

**8273**

2-3/4" Long  
For 1/4" Hole  
In .115" Thick Metal  
Black Nylon  
UNIT PKG: 50



**5853**

(4000305)  
2-7/8" Long  
Natural Nylon  
UNIT PKG: 50

**9115**

4" Long  
Black Nylon  
UNIT PKG: 50



**10649**  
(3816659)

6-1/2" Long  
Black Nylon  
UNIT PACKAGE: 10



1 Feed Cable Tie in  
Tool Head, Pull  
Trigger To Tension.

**14568**

Cable Tie Tool



2 Hold Trigger  
Tension And Twist  
Tool 1/2 Turn

A light-weight, durable hand tool that's perfect for installing cable ties. The tool works on 18 pound, 30 pound, 40 pound, and 50 pound tensile rated cable ties. Measures 6-1/4" long. Made of rugged plastic.

UNIT PACKAGE: 1

**Self-Clamping Natural Nylon Straps (Reusable)**

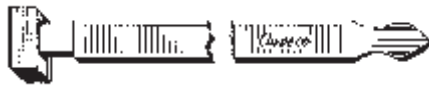

Auveco Part No.	Tensile Strength	Strap Length	Max Bundle Dia.	Width	Unit Pkg.
10217	18 lb.	3-7/8"	3/4"	3/32"	10
9636	50 lb.	6-5/8"	1-3/4"	3/16"	10
9637	50 lb.	14-7/8"	4"	3/16"	10
10218	120 lb.	14-1/2"	4"	9/32"	10

**Black Nylon Cable Ties Self Clamping**



Auveco Part No.	Tensile Strength	Length	Width	Unit Pkg.
15144	18 lb.	4"	3/32"	100
15196	18 lb.	4"	3/32"	1000
15145	30 lb.	5-1/2"	1/8"	100
15197	30 lb.	5-1/2"	1/8"	1000
15146	50 lb.	7"	3/16"	50
15198	50 lb.	7"	3/16"	1000
15147	50 lb.	11"	3/16"	50
15199	50 lb.	11"	3/16"	500
15753	50 lb.	14"	3/16"	25
15148	120 lb.	14"	5/16"	25
15200	120 lb.	14"	5/16"	500

**Natural Nylon Cable Ties Self Clamping**



Auveco Part No.	Tensile Strength	Length	Width	Unit Pkg.
11953	18 lb.	3"	3/32"	50
11954	18 lb.	4"	3/32"	50
14836	18 lb.	4"	3/32"	100
15188	18 lb.	4"	3/32"	1000
11955	30 lb.	5"	1/8"	50
14837	30 lb.	5"	1/8"	100
15189	30 lb.	5"	1/8"	1000
11956	50 lb.	7"	5/32"	25
14838	50 lb.	7"	5/32"	50
15190	50 lb.	7"	5/32"	1000
11957	50 lb.	11"	5/32"	25
14839	50 lb.	11"	5/32"	50
15191	50 lb.	11"	5/32"	500
15754	50 lb.	14"	5/32"	25
11958	120 lb.	14"	9/32"	10
14840	120 lb.	14"	9/32"	25
15192	120 lb.	14"	9/32"	500

**Black Nylon-Cable Ties Self-Clamping With Mounting Hole**

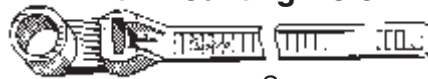

Auveco Part No.	Tensile Strength	Length	Screw Hole Size	Width	Unit Pkg.
15149	30 lb.	6"	#8	1/8"	50
15201	30 lb.	6"	#8	1/8"	500
15150	50 lb.	7-1/2"	#10	3/16"	50
15202	50 lb.	7-1/2"	#10	3/16"	250
15151	120 lb.	14-3/4"	#14	5/16"	25
15203	120 lb.	14-3/4"	#14	5/16"	200

**Natural Nylon-Cable Ties Self-Clamping With Mounting Hole**



Auveco Part No.	Tensile Strength	Length	Screw Hole Size	Width	Unit Pkg.
11960	30 lb.	5"	#8	1/8"	50
15193	30 lb.	5"	#8	1/8"	250
11961	50 lb.	7"	#10	5/32"	50
15194	50 lb.	7"	#10	5/32"	250
11963	120 lb.	13"	#14	9/32"	10
15195	120 lb.	13"	#14	9/32"	100

**12360**  
Natural Nylon



Ideal for light duty applications, it uses a #6 flat head screw or 1/8" flat head rivet. The mount features a 4 way insertion and accepts 18, 30, and 50 pound cable ties. Size: 1" x 1"

UNIT PACKAGE: 10

These 4 way insertion mounts offer the same features as our 12360 mount with the addition of a pressure sensitive adhesive on the back. Size: 1" x 1"

**12361**  
Natural Nylon

UNIT PKG: 10



**16001**  
Black Nylon

UNIT PKG: 10



**12362**

Ideal for high density applications, use a #8 screw. Once the mount is secured the tie is slipped over the mount and applied as usual.

UNIT PACKAGE: 25





## Steel With Rubber Seal Oil Drain Plug Gaskets

Auveco Part No.	I.D.	O.D.	Thick- ness	Unit Pkg.
<b>16026</b> .....	1/2"	1"	3/64"	5
<b>18299</b> .....	14mm	25mm	1mm	10
<b>18931</b> .....	16mm	24mm	2mm	10
<b>18932</b> .....	18mm	27mm	2mm	10

## Oil Drain Plug Rubber Gasket



**18665**  
I.D.: 11mm  
O.D.: 21mm  
Replacement Gasket  
For Auveco No. 18663 & 18664  
GM 12mm-1.75  
Oil Drain Plugs  
UNIT PACKAGE: 10

**19630**  
I.D.: 11mm  
O.D.: 25mm  
Replacement Gasket  
For Auveco. No. 18023  
GM 12mm-1.75  
Oil Drain Plugs  
UNIT PACKAGE: 10

**20453**  
(F5TZ-6734-BA)  
I.D.: 13mm, O.D.: 22mm  
Replacement Gasket  
For Auveco Oil Drain Plug 19279  
Ford Aerostar, Explorer & Ranger  
6 Cyl. 4 Ltr. Eng.  
1996 - On  
UNIT PACKAGE: 10



## Oil Drain Plug Gaskets

On vehicles equipped with aluminum gaskets, a new aluminum gasket must be installed at each oil change

Auveco Part No.	I.D.	O.D.	Thick- ness	Mat.	Unit Pkg.
<b>19538</b> .....	1/2"	3/4"	5/64"	Bk. Fibre	50
<b>8277</b> .....	1/2"	3/4"	3/32"	Nylon	25
<b>15918</b> .....	1/2"	7/8"	1/16"	Copper	25
<b>19590</b> .....	1/2"	7/8"	1/16"	Alum	25
<b>16996</b> .....	1/2"	15/16"	1/16"	Nylon	25
<b>18019</b> .....	1/2"	15/16"	5/64"	Fibre	50
<b>19539</b> .....	9/16"	13/16"	5/64"	BK. Fibre	50
<b>8281</b> .....	9/16"	13/16"	3/32"	Nylon	25
<b>15919</b> .....	9/16"	13/16"	3/32"	Copper	25
<b>8278</b> .....	5/8"	1"	3/32"	Nylon	25
<b>18021</b> .....	3/4"	1"	1/16"	Copper	25
<b>8279</b> .....	3/4"	1-1/16"	3/32"	Nylon	25
<b>8280</b> .....	7/8"	1-1/8"	3/32"	Nylon	25
<b>18849</b> .....	12mm	21mm	1.8mm	Steel*	5
<b>16680</b> .....	12mm	22mm	1.5mm	Nylon	50
<b>19591</b> .....	12mm	22mm	1.5mm	Copper	15
<b>19601</b> .....	12mm	22mm	1.5mm	Alum	50
<b>18726</b> .....	12mm	22mm	2mm	Bk. Fibre	50
<b>17628</b> .....	12mm	22mm	2.5mm	Grn Fibre	25
<b>19621</b> .....	14mm	20mm	1mm	Alum	50
<b>20454</b> .....	14mm	20mm	1.5mm	Copper	15
<b>19592</b> .....	14mm	22mm	1.5mm	Copper	15
<b>16956</b> .....	14mm	22mm	2mm	Alum	50
<b>16681</b> .....	14mm	24mm	1.5mm	Nylon	50
<b>18828</b> .....	14mm	24mm	1.5mm	Grn Fibre	25
<b>16682</b> .....	14mm	24mm	2mm	Bk Fibre	50
<b>19604</b> .....	16mm	22mm	1.5mm	Copper	15
<b>19652</b> .....	16mm	27mm	2mm	Bk Fibre	50
<b>19603</b> .....	16.4mm	27mm	2mm	Bk Fibre	50
<b>16683</b> .....	16.5mm	27mm	1.5mm	Nylon	50
<b>20462</b> .....	18mm	24mm	1.2mm	Aluminum	25
<b>16955</b> .....	18mm	25.5mm	2mm	Alum	50
<b>16957</b> .....	18mm	28mm	2mm	Grn Fibre	50
<b>16684</b> .....	18mm	29mm	1.5mm	Nylon	50
<b>19605</b> .....	18mm	26mm	1.5mm	Copper	10
<b>18829</b> .....	18mm	29mm	1.5mm	Grn Fibre	25
<b>19139</b> .....	20mm	26mm	2mm	Steel	15
<b>16685</b> .....	20mm	28mm	1.5mm	Nylon	50
<b>19593</b> .....	20mm	28mm	1.6mm	Copper	10
<b>18830</b> .....	20mm	28mm	1.5mm	Grn Fibre	25
<b>18020</b> .....	25.5mm	35mm	2mm	Bk Fibre	50

\* Teflon coated steel

## Oil Drain Plug Crushable Gaskets



Auveco Part No.	I.D.	O.D.	Thick- ness	Material	Unit Pkg.
<b>19545</b> .....	1/2"	3/4"	5/64"	Copper	10
<b>19319</b> .....	12mm	17mm	2mm	Steel	15
<b>17261</b> .....	12mm	18mm	2mm	Copper	10
<b>19007</b> .....	14mm	19mm	2mm	Steel	10
<b>17262</b> .....	14mm	20mm	2mm	Copper	10
<b>17263</b> .....	16mm	22mm	2mm	Copper	10
<b>17264</b> .....	18mm	24mm	2mm	Copper	10
<b>17265</b> .....	20mm	26mm	2mm	Copper	10

## Sec. 13

# OIL DRAIN PLUGS (WITH GASKETS)

### 14196

Plain

Thread: 1/2"-20  
Hex: 7/8"  
Length Under Head: 1/2"

Fits the following 1/2"-20 applications:

#### AMC

6 & 8 Cyl. All 64-On

#### Buick

4, 6 & 8 Cyl. All [Exc. 2.5 (151), 3.0, 4.3, 4.9 (301 Eng.)] 59-On

#### Cadillac

6 & 8 Cyl. All (Exc. 4.1 Eng) 66-On

#### Chevrolet (Includes Light Truck)

4, 6 & 8 Cyl. All [Exc. 1.8 (diesel), 2.5 (151), 4.3 (diesel) Eng.] 28-On

#### Chrysler Corp.

6 & 8 Cyl. All 62-On

#### Ford Motor Co.

4, 6 & 8 Cyl. All (Exc. 98, 122, 140, 171 Eng) 57-On

**GMC** (Light Truck) 6 & 8 Cyl. All 39-On

#### Oldsmobile

4, 6 & 8 Cyl. All [Exc. 2.5 (151), 3.0, 4.3, (diesel), 4.3S, 4.9T (301)] 61-On

#### Pontiac

4, 6, & 8 Cyl. All [Exc. 1.8 (diesel), 2.5 (151), 4.3 (diesel), 4.3S, 4.9T (301)] 60-On

UNIT PACKAGE: 10



### 19130

(3921988)

Plain

Thread: 1/2"-20  
Hex: 9/16"  
Length Under Head: 13/16"  
Washer Head O.D.: 7/8"

#### Buick

4, 6 & 8 Cyl. All [Exc. 2.5(151) 3.0, 4.3, 4.9 (301 Eng.)] 59-On

#### Cadillac

6 & 8 Cyl. All (Exc. 4.1 Eng) 66-On

#### Chevrolet (Inc. GMC Light Truck)

4, 6 & 8 Cyl. All [Exc. 1.8 (diesel), 2.5 (151), 4.3 (diesel) Eng.] 28-On

#### Oldsmobile

4, 6 & 8 Cyl. All [Exc. 1.8 (diesel), 2.5 (151), 3.0, 4.3, (diesel), 4.3S, 4.9T (301) Eng.] 61-On

#### Pontiac

4, 6 & 8 Cyl. All [Exc. 1.8 (diesel), 2.5 (151), 4.3 (diesel), 4.3S, 4.9T (301) Eng.] 60-On

UNIT PACKAGE: 15



### 18373

(6034376)

Plain With Rubber Washer Face Gasket

Thread: 1/2"-20  
Hex: 5/8"  
Length Under Head: 13/16"  
Rubber Gasket O.D.: 1-3/32"

Fits the following applications:

#### Chrysler

UNIT PACKAGE: 2



### 18022

(948187-0)

Zinc

Thread: 3/4"-16  
Hex: 1"  
Length Under Head: 1/2"

Fits the following applications:

#### Volvo: 4 Cyl.

UNIT PACKAGE: 2

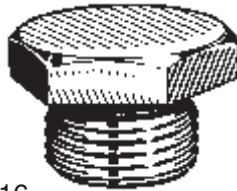

### 15527

Zinc

Thread M12-1.25  
Hex: 14mm  
Length Under Head: 11mm  
Washer Head O.D.: 20mm

Fits the Following M12-1.25 applications:

#### Nissan

Sentra, Stanza & Pulsar w/ FWD 82-On

UNIT PACKAGE: 5



### 19589

Zinc

Thread M12-1.5  
Hex: 13mm  
Length Under Head: 12mm  
Washer Head O.D.: 17mm

Fits The Following Applications:

#### BMW & Mercedes

UNIT PACKAGE: 5



### 19588

Zinc

Thread: M12-1.25  
Hex: 14mm  
Length Under Head: 17mm  
Washer Head O.D.: 20mm

Fits The Following Applications:

#### Nissan

UNIT PACKAGE: 5



### 18023

(21006725)

Black Zinc With Rubber Gasket

Thread: M12-1.75  
Hex: 14mm  
Length Under Head: 19mm  
Rubber Gasket O.D.: 31mm

Fits the following application:

#### GM: Saturn

UNIT PACKAGE: 2

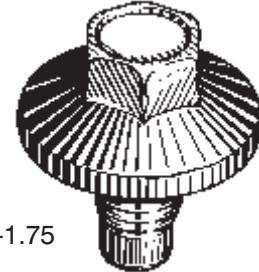

### 18374

(F5AZ-6730)

Plain With Rubber Washer Face Gasket

Thread: M12-1.75  
Hex: 15mm  
Length Under Head: 21mm  
Rubber Gasket O.D.: 28mm

Fits the following applications:

**Ford** 2.5, 3.0 & 4.6 Eng. With Modular & Aluminum Pans

UNIT PACKAGE: 2



### 18664

(3538469)

Black With Rubber Gasket

Thread M12-1.75  
Hex: 15mm  
Length Under Head: 25mm  
Washer Head O.D.: 31mm

Fits the following applications:

#### GM 4.9 Eng. 1985-On

UNIT PACKAGE: 2



# OIL DRAIN PLUGS (WITH GASKETS)

## Sec. 13

**20347**  
(YS4Z-6730AA)  
Plain With  
Rubber Gasket



Thread: M12-1.75  
Hex: 13mm  
Length Under Head: 25mm  
Washer Head O.D.: 26mm  
Fits the following applications:  
**Ford** 1999 - 93  
UNIT PACKAGE: 2

**20372**  
(24100042)  
Zinc & Yellow  
With Rubber  
Gasket



Magnetic  
Thread: M12-1.75  
Hex: 15mm  
Length Under Head: 30mm  
Washer Head O.D.: 26mm  
Fits the following M12-1.75  
Applications:  
**GM** 1990-On  
UNIT PACKAGE: 2

**20426**  
(90009-PY3-000)  
Zinc & Yellow  
With Aluminum  
Gasket



Thread: M14-1.5  
Hex: 17mm  
Length Under Head: 15mm  
Washer Head O.D.: 24mm  
Fits the following M14-1.5  
Applications:  
**Acura & Honda** 2000 - On  
UNIT PACKAGE: 5

**18663**  
(3536964)  
Black With  
Rubber Gasket



Thread: M12-1.75  
Hex: 15mm  
Length Under The Head: 25mm  
Washer Head O.D.: 26mm  
Fits the following applications:  
**GM** 2.2 (4), 3.1 (M), 3.8 (K), 3.8  
(1), & 2.3 Eng. 1992-On  
UNIT PACKAGE: 2

**18024**  
Zinc



Thread: M14-1.25  
Hex: 13mm  
Length Under Head: 16mm  
Washer Head O.D.: 23mm  
Fits the following applications:  
**Jeep**  
UNIT PACKAGE: 5

**18025**  
Zinc

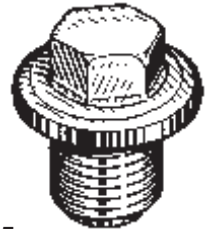

Thread: M14-1.5  
Hex 13mm  
Length Under Head: 16mm  
Washer Head O.D.: 23mm  
Fits the following applications:  
**Ford:** Escort  
UNIT PACKAGE: 5

**14677**  
Zinc

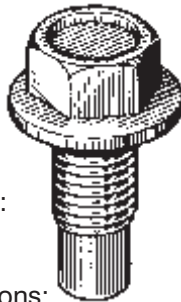

Thread: M12-1.75  
Hex: 15mm  
Length Under  
Head: 26mm  
Washer Head O.D.:  
22mm  
Fits the following  
M12-1.75 applications:  
**Buick**  
4 Cyl. 151 (2.5) Eng. 80-On  
6 Cyl. 3.0, 4.3 (Diesel) Eng. 82-On  
8 Cyl. 4.3, 4.9 Eng. 81-77  
**Cadillac**  
8 Cyl. 4.1 Eng. 82-On  
**Chevrolet**  
4 Cyl. 151 (2.5) Eng. 78-On  
6 Cyl. 4.3 (Diesel) Eng. 82-On  
**Oldsmobile**  
4 Cyl. 151 (2.5) Eng. 78-On  
6 Cyl. 3.0, 4.3 (Diesel) Eng. 82-On  
8 Cyl. 4.3S, 4.9T (301) Eng. 80-79  
**Pontiac**  
4 Cyl. 151 (2.5) Eng. 77-On  
6 Cyl. 4.3 (Diesel) Eng. 82-On  
8 Cyl. 4.3S, 4.9T (301) Eng. 81-77  
UNIT PACKAGE: 5

**16308**  
Zinc



Thread: M14-1.5  
Hex: 16mm  
Length Under Head: 11mm  
Washer Head O.D.: 25mm  
Fits The Following  
M14-1.5 Applications:  
**Chrysler Imports** 83-On  
**Honda** 83-On  
**Isuzu** 87-On  
**Mazda** 72-On  
**Spectrum** 88-On  
**Sprint** 88-On  
**VW-Audi** 74-On  
UNIT PACKAGE: 5

**18375**  
(6503433)  
Plain With  
Rubber Washer  
Face Gasket



Thread: M14-1.50  
Hex: 17mm  
Length Under Head: 18mm  
Rubber Gasket O.D.: 28mm  
Fits the following applications:  
**Chrysler** 1.5 & 2.0 Eng.  
UNIT PACKAGE: 2

**All Items Available  
In Bulk  
Call For A Quotation**

## Sec. 13

## OIL DRAIN PLUGS (WITH GASKETS)

### 19141

(6504018)  
Plain With  
Rubber  
Washer Face  
Gasket



Thread: M14-1.50  
Hex: 13mm  
Length Under Head: 20mm  
Rubber Gasket O.D.: 28mm

Fits the following applications:

**Chrysler** 2.0, 2.4, 2.7, 3.2, 3.5, 3.7  
& 4.7 Eng. 2000 - On

UNIT PACKAGE: 2

### 19773

(F75Z-6730-BA)  
Phosphate With  
Rubber Gasket

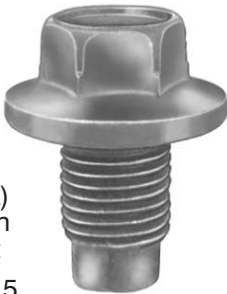

Thread: M14-1.5  
Hex: 16mm  
Length Under Head: 20mm  
Washer Head O.D.: 28mm

Fits the following applications:

**Ford** Vans & Trucks  
With 6.8L Eng. 2000-96

UNIT PACKAGE: 1

### 19279

(Chrysler: 6507741AA;  
Ford: F6TZ-6730BA)  
Phosphate  
With Rubber Gasket



Thread M14-1.50  
Hex: 13mm  
Length Under Head: 20mm  
Washer Head O.D.: 28mm

Fits the following applications:

**Chrysler** with 2.0(F), 2.4(B,G,8),  
2.7(R,T), 3.3(G,S,3) & 3.5(G,4)  
Eng. 2000 - On

**Ford** Aerostar, Explorer & Ranger  
6 Cyl. 4 Ltr. Eng. 1996-On

UNIT PACKAGE: 2

### 14678

Plain

Thread M14-1.5  
Hex 16mm  
Length Under  
Head: 20mm  
Washer Head O.D.:  
25mm

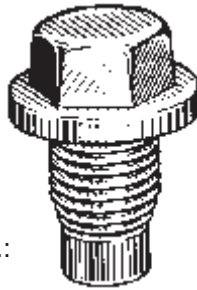

Fits the following M14-1.5  
applications:

**AMC**

4 Cyl. VW 121 Eng. 79-77

**Chevrolet**

4 Cyl. 1.8 (Diesel) Eng. 81-On

**Chrysler Corp** (Exc. Imports)

4 Cyl. All 78-On

**Chrysler Corp.** Imports

4 Cyl. All 83-On

4 Cyl. K & W Engines

(built after 10-81) 82

**Ford Motor Co.**

4 & 6 Cyl. 98, 122, 140, 171 Eng.  
73-On

**Honda** 4 Cyl. Prelude 83-On

**Mazda** 4 Cyl. All 72-On

**Pontiac** 4 Cyl. 1.8 (Diesel) 83-On

**Volkswagen**

4 Cyl. All (Water Cooled Engine)  
74-On

UNIT PACKAGE: 5

### 18026

(601-997-02-30)  
Zinc

Thread: M14-1.5  
Hex: 13mm  
Length Under Head:  
24mm  
Washer Head O.D.:  
19mm



Fits the following applications:

**Mercedes:** 300 Series

UNIT PACKAGE: 2

### 15528

Zinc

Thread M16.4-1.33 O.S.  
Hex 19mm  
Length Under Head: 13mm  
Washer Head O.D.: 26mm

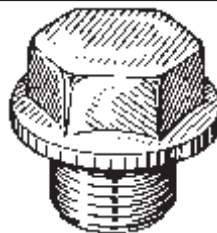

Fits the Following M16.4 O.S.  
applications:

**Nissan:** All (Exc. Sentra, Stanza &  
Pulsar w/FWD 62-On

**Renault:** Fuego & LeCar 80-On

UNIT PACKAGE: 5

### 15529

Zinc

Thread: M18-1.5  
Hex: 19mm  
Length Under Head: 12mm  
Washer Head O.D.: 29mm

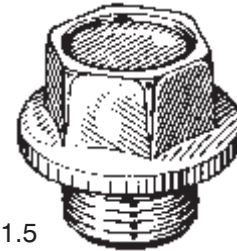

Fits the Following M18-1.5  
applications:

**Chrysler:** All imports 70-On

**Renault:** LeCar 79-76

**Toyota:** All 75-On

UNIT PACKAGE: 5

### 15530

Plain

Thread: M20-1.5  
Hex: 15mm  
Length Under Head: 21mm  
Washer Head O.D.: 29mm

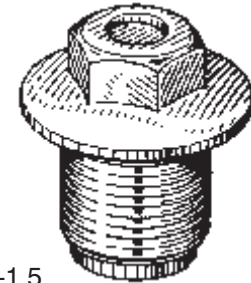

Fits the Following  
M20-1.5 applications:

**Chevrolet Truck:**

Luv 82-75

**Honda:**

All exc. Prelude 73-On

**Subaru:** All 79-On

UNIT PACKAGE: 5

### 18027

Zinc

Thread: M25-1.5  
Hex: 24mm  
Length Under Head: 13mm  
Washer Head O.D.: 35mm

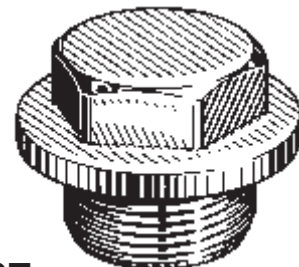

Fits the following applications:

**Toyota**

UNIT PACKAGE: 1

**Magnetic Oil Drain Plugs (With Gaskets)**  
Zinc Plated



Type 1

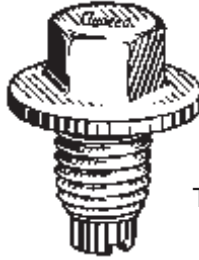

Type 2



Type 3

Auveco Part No.	Type	Thread Size	Hex	Length Under Head	Finish	Unit Pkg.
19365	3	1/2"-20	3/4"	43/64"	Zinc	1
17145	1	1/2"-20 Single Oversize	3/4"	13/16"	Zinc	2
17146	1	1/2"-20 Double Oversize	3/4"	13/16"	Zinc & Yellow	2
17147	1	1/2"-20 Triple Oversize	3/4"	13/16"	Black Zinc	2
17148	2	12mm-1.75	13mm	19mm	Zinc	2

**Oversize "Piggy-Back" Drain Plugs With Gasket**



**11782**

1/2"-20 Single Oversize  
Zinc

UNIT PACKAGE: 5

**11783**

1/2"-20 Double Oversize  
Zinc & Yellow

UNIT PACKAGE: 5

**Oversize Oil Pan Drain Plugs**

With Fibre Gaskets

Self-Tapping



Metric



Standard

Auveco Part No.	Size	Finish	Unit Pkg.
19587	1/2"-20 Single Oversize	Zinc	5
18121	1/2"-20 Double Oversize	Zinc & Yellow	5
18122	1/2"-20 Triple Oversize	Black Zinc	5
8285	5/8"-18 Single Oversize	Zinc	5
8286	11/16"-20 Single Oversize	Zinc	5
8288	3/4"-16 Single Oversize	Zinc	5
8289	7/8"-18 Single Oversize	Zinc	5
19618	M12-1.25 Single Oversize	Zinc	5
19619	M12-1.75 Single Oversize	Zinc	5
19620	M14-1.40 Single Oversize	Zinc	5

**Transmission Drain Plug**

(With Gasket)



**19318**

(Jeep: 83504041;  
Lexus: 90341-10006,  
90341-10012)  
Zinc & Yellow

Thread: M10-1.5; Hex: 14mm

Length Under Head: 9mm

Fits the following applications:

**Jeep** Cherokee, Comanche & XJ 1991-On

**Lexus** GS300, LS400 & SC400 1991-On

UNIT PACKAGE: 2

# Sec. 13

## GREASE FITTINGS (Also Available In Large Bulk Quantities)

Ref. No:  
1792



1/4"-28, Straight  
Thread Length: 9/64"  
Overall Length: 1/2"  
Ball Check, Plated

15055 Unit Pkg: 50  
15074 Unit Pkg: 250  
15075 Unit Pkg: 500  
15440 Unit Pkg: 1000

Ref. No:  
1641



1/4"-28, Straight  
Thread Length: 7/32"  
Overall Length: 9/16"  
Ball Check, Plated

9257 Unit Pkg: 50  
15100 Unit Pkg: 250  
15101 Unit Pkg: 500  
15415 Unit Pkg: 1000

Ref. No:  
1652



1/4"-28 Straight  
Overall Length: 11/16"  
Ball Check, Plated

9258 Unit Pkg: 50  
15102 Unit Pkg: 250  
15103 Unit Pkg: 500  
15416 Unit Pkg: 1000

Ref. No:  
1680



1/4"-28, Straight  
Overall Length: 15/16"  
Ball Check, Plated

9259 Unit Pkg: 25  
15104 Unit Pkg: 100  
15417 Unit Pkg: 1000

Ref. No:  
5530



1/4"-28, Straight  
Self-Tapping  
Overall Length: 9/16"  
Ball Check, Plated

15000 Unit Pkg: 50  
15068 Unit Pkg: 250  
15069 Unit Pkg: 500

Ref. No:  
1637



1/4"-28, 45°  
Overall Length: 29/32"  
Ball Check, Plated

9260 Unit Pkg: 25  
15106 Unit Pkg: 100  
15107 Unit Pkg: 250  
15418 Unit Pkg: 1000

Ref. No:  
1636



1/4"-28, 45°  
Thread Length: .3"  
Overall Length: 1"  
Ball Check, Plated

15056 Unit Pkg: 25  
15076 Unit Pkg: 100  
15077 Unit Pkg: 250  
15441 Unit Pkg: 1000

Ref. No:  
5545



1/4"-28, 45°  
Self-Tapping  
Overall Length: 55/64"  
Ball Check, Plated

19172 Unit Pkg: 25

Ref. No:  
1665



1/4"-28, 65°  
Overall Length: 25/32"  
Ball Check, Plated

15053 Unit Pkg: 25  
15070 Unit Pkg: 100  
15071 Unit Pkg: 250  
15438 Unit Pkg: 1000

Ref. No:  
1911



1/4"-28, 90°  
Overall Length: 45/64"  
Ball Check, Plated

9261 Unit Pkg: 25  
15108 Unit Pkg: 100  
15109 Unit Pkg: 250  
15419 Unit Pkg: 1000

Ref. No:  
5590



1/4"-28, 90°  
Self-Tapping  
Over Length: 43/64"  
Ball Check, Plated

19176 Unit Pkg: 25  
19177 Unit Pkg: 100  
19178 Unit Pkg: 250

Ref. No:  
1743



1/4" Drive Fit  
Straight  
Overall Length: 1/2"  
Ball Check, Plated

15054 Unit Pkg: 25  
15072 Unit Pkg: 100  
15073 Unit Pkg: 250  
15439 Unit Pkg: 1000











Ref. No:  
1952



1/4" Drive Fit, Straight  
Overall Length: 27/64"  
No Check Valve  
Plated

15065 Unit Pkg: 50  
15094 Unit Pkg: 250  
15450 Unit Pkg: 1000

**GREASE FITTINGS**  
(Also Available In Large Bulk Quantities)

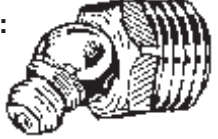
<p><b>Ref No:</b> 1610</p>  <p>1/8" Pipe, St. Overall Length: 5/8" Ball Check, Plated</p> <p><b>9262</b> Unit Pkg: 50 <b>15110</b> Unit Pkg: 250 <b>15111</b> Unit Pkg: 500 <b>15420</b> Unit Pkg: 1000</p>	<p><b>Ref. No:</b> 1688</p>  <p>1/8" Pipe, 45° Overall Length: 1" Ball Check, Plated</p> <p><b>9264</b> Unit Pkg: 25 <b>15114</b> Unit Pkg: 100 <b>15115</b> Unit Pkg: 250 <b>15422</b> Unit Pkg: 1000</p>	<p><b>Ref. No:</b> 1612</p>  <p>1/8" Pipe, 65° Overall Length: 7/8" Ball Check, Plated</p> <p><b>9265</b> Unit Pkg: 25 <b>15116</b> Unit Pkg: 100 <b>15117</b> Unit Pkg: 250 <b>15423</b> Unit Pkg: 1000</p>
<p><b>Ref No:</b> 1607</p>  <p>1/8" Pipe, St. Overall Length: 1-1/4" Ball Check, Plated</p> <p><b>9267</b> Unit Pkg: 25 <b>15120</b> Unit Pkg: 100 <b>15121</b> Unit Pkg: 250</p>	<p><b>Ref. No:</b> 5570</p>  <p>1/8" Pipe, St. Self-Tapping Overall Length: 39/64" Ball Check, Plated Nominal Hole Size: 3/8"</p> <p><b>15066</b> Unit Pkg: 25 <b>15096</b> Unit Pkg: 100 <b>15097</b> Unit Pkg: 250</p>	<p><b>Ref. No:</b> 1613</p>  <p>1/8" Pipe, 90° Overall Length: 53/64" Ball Check, Plated</p> <p><b>9266</b> Unit Pkg: 25 <b>15118</b> Unit Pkg: 100 <b>15119</b> Unit Pkg: 250 <b>15424</b> Unit Pkg: 1000</p>
<p><b>Ref. No:</b> 1728</p>  <p>3/16" Drive Fit, St. Overall Length: 1/2" Ball Check, Plated</p> <p><b>15060</b> Unit Pkg: 50 <b>15084</b> Unit Pkg: 250 <b>15085</b> Unit Pkg: 500</p>	<p><b>Ref. No:</b> 1711</p>  <p>5/16"-24, Straight Overall Length: 5/8" Ball Check, Plated</p> <p><b>15057</b> Unit Pkg: 25 <b>15078</b> Unit Pkg: 100 <b>15079</b> Unit Pkg: 250</p>	<p><b>Ref. No:</b> 1608</p>  <p>5/16" Drive Fit, St. Overall Length: 9/16" Ball Check, Plated</p> <p><b>15061</b> Unit Pkg: 50 <b>15086</b> Unit Pkg: 250 <b>15087</b> Unit Pkg: 500 <b>15446</b> Unit Pkg: 1000</p>
<p><b>Ref. No:</b> 1710</p>  <p>3/8"-24, Straight Overall Length: 5/8" Ball Check, Plated</p> <p><b>15058</b> Unit Pkg: 25 <b>15080</b> Unit Pkg: 100</p>	<p><b>Ref. No:</b> 1627</p>  <p>1/4" Pipe, St. Overall Length: 27/32" Ball Check, Plated</p> <p><b>15059</b> Unit Pkg: 25 <b>15082</b> Unit Pkg: 100 <b>15083</b> Unit Pkg: 250 <b>15444</b> Unit Pkg: 1000</p>	<p><b>Ref. No:</b> 1629</p>  <p>1/4" Pipe, 65° Overall Length: 1" Ball Check, Plated</p> <p><b>15062</b> Unit Pkg: 10 <b>15088</b> Unit Pkg: 50 <b>15089</b> Unit Pkg: 100</p>

# Sec. 13

## METRIC GREASE FITTINGS (Also Available In Large Bulk Quantities)

Ref No:  
8601



6mm-1.00, Straight  
DIN 71412  
Overall Length: 14mm  
Ball Check, Plated

11097 Unit Pkg: 5  
15122 Unit Pkg: 50  
15123 Unit Pkg: 100  
15426 Unit Pkg: 1000

Ref. No:  
7045



6mm-1.00, 45°  
Overall Length: 22mm  
Ball Check, Plated

11775 Unit Pkg: 10  
15132 Unit Pkg: 50  
15133 Unit Pkg: 100  
15431 Unit Pkg: 1000

Ref No:  
7090

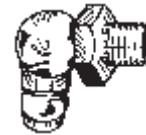

6mm-1.00, 90°  
Overall Length: 18mm  
Ball Check, Plated

11776 Unit Pkg: 10  
15134 Unit Pkg: 50  
15135 Unit Pkg: 100

Ref No:  
8901



8mm-1.00, Straight  
DIN 71412  
Overall Length: 15mm  
Ball Check, Plated

11098 Unit Pkg: 5  
15124 Unit Pkg: 50  
15125 Unit Pkg: 100

Ref No:  
7445



8mm-1.00, 45°  
Overall Length: 23mm  
Ball Check, Plated

11777 Unit Pkg: 10  
15136 Unit Pkg: 50  
15137 Unit Pkg: 100

Ref No:  
7490



8mm-1.00, 90°  
DIN 71412  
Overall Length:  
18mm  
Ball Check, Plated

11099 Unit Pkg: 5  
15126 Unit Pkg: 50  
15127 Unit Pkg: 100

Ref No:  
9201



8mm-1.25, Straight  
Overall Length: 15mm  
Ball Check, Plated

11778 Unit Pkg: 10  
15138 Unit Pkg: 50  
15139 Unit Pkg: 100  
15434 Unit Pkg: 1000

Ref No:  
7545



8mm-1.25, 45°  
Overall Length: 23mm  
Ball Check, Plated

11779 Unit Pkg: 10  
15140 Unit Pkg: 50  
15141 Unit Pkg: 100

Ref No:  
7590



8mm-1.25, 90°  
Overall Length: 18mm  
Ball Check, Plated

11780 Unit Pkg: 10  
15142 Unit Pkg: 50  
15143 Unit Pkg: 100  
15436 Unit Pkg: 1000

Ref No:  
9301



10mm-1.00, Straight  
DIN71412  
Overall Length: 15mm  
Ball Check, Plated

11100 Unit Pkg: 5  
15128 Unit Pkg: 50  
15129 Unit Pkg: 100

Ref No:  
9345



10mm-1.00, 45°  
Overall Length: 23mm  
Ball Check, Plated

15067 Unit Pkg: 25  
15098 Unit Pkg: 100  
15099 Unit Pkg: 250

Ref No:  
9390

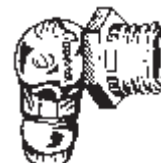

10mm-1.00, 90°  
DIN 71412  
Overall Length:  
19mm  
Ball Check, Plated

11101 Unit Pkg: 5  
15130 Unit Pkg: 50  
15131 Unit Pkg: 100

Ref. No:  
9501







10mm-1.5 Straight  
Overall Length: 15mm  
Ball Check, Plated

17555 Unit Pkg: 50

**Please Order In  
Unit Package Quantity  
Not Pieces.**



**STAINLESS STEEL  
GREASE FITTINGS WITH BALL CHECK**  
303 Series Body • 420 Series Ball • 302 Series Spring

 <p align="center"><b>17154</b></p> <p>Ref. No: 8082</p> <p>1/8" Pipe, Straight Overall Length: 5/8"</p> <p>UNIT PACKAGE: 5</p>	<p align="center"><b>Remember.... All Items In This Catalog Are Available In Bulk. Call For A Quote.</b></p>	 <p align="center"><b>17676</b></p> <p>Ref. No: 8043</p> <p>1/4" Drive Fit, Straight Overall Length: 1/2"</p> <p>UNIT PACKAGE: 10</p>
 <p align="center"><b>17155</b></p> <p>Ref. No: 8036</p> <p>6mm-1.00, Straight Overall Length: 14mm</p> <p>UNIT PACKAGE: 5</p>		 <p align="center"><b>17156</b></p> <p>Ref. No: 8058</p> <p>8mm-1.00, Straight Overall Length: 15mm</p> <p>UNIT PACKAGE: 5</p>

***Do You Want Your Customers  
To Know You Use The Best Body Hardware  
& Specialty Fasteners Available?***

***Promotional Products And Apparel Bearing***

***The  Logo Promote Your Identity  
As A Professional.***

**GREASE FITTING TOOLS & GUNS**

**4-Way Grease Fitting Tools**

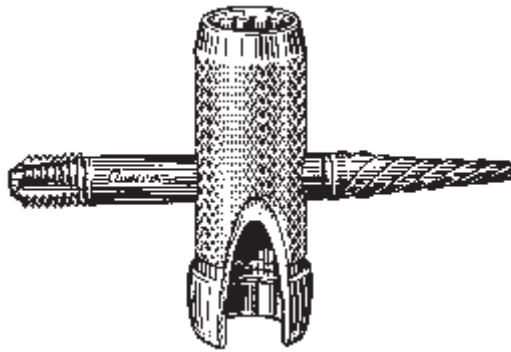

**15693**

For popular 1/4-28 and 6mm fittings. Tap repairs 1/4-28 threads. Wrench removes 5/16" and 3/8" hex fittings and plugs. Installs new 1/4-28 fittings. "Easy-out" removes broken fittings.

UNIT PACKAGE: 1

**15694**

For 1/8" NPT fittings. Tap repairs 1/8" NPT threads. Wrench removes 7/16" and 3/8" hex fittings and plugs. Installs new 1/8" NPT fittings. "Easy Out" removes broken fittings.

UNIT PACKAGE: 1

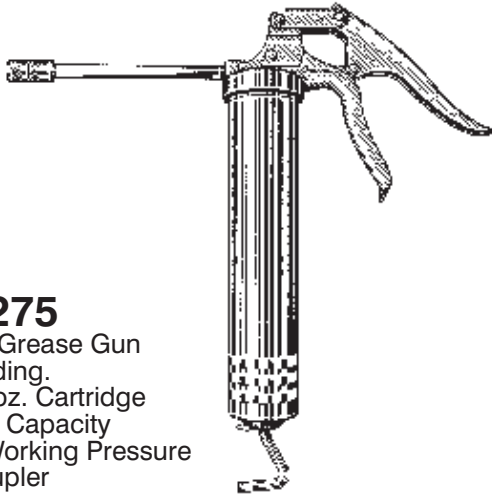

**16275**

One-Hand Grease Gun  
3-Way Loading.  
Uses 14.5 oz. Cartridge  
16 oz. Bulk Capacity  
2500 PSI Working Pressure  
3 Claw Coupler  
Blue

UNIT PACKAGE: 1

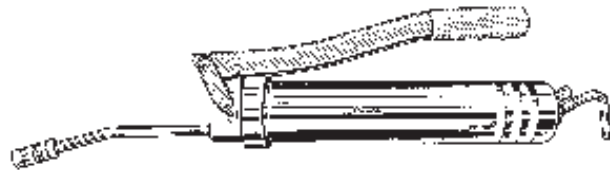

**16276**

Heavy Duty Grease Gun  
3-Way Loading  
Uses 14.5 oz. Cartridge  
16 oz. Bulk Capacity  
10,000 PSI Working Pressure  
3 Claw Coupler  
Blue With Orange Vinyl Grip

UNIT PACKAGE: 1

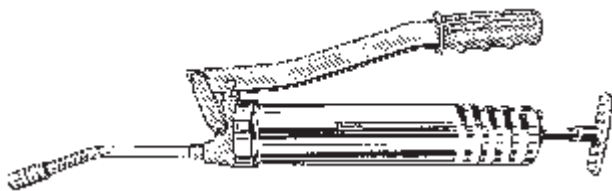

**16277**

Professional Grease Gun  
Delivers Grease At Various Lever Openings  
3-Way Loading  
Uses 14.5 oz. Cartridge  
16 oz. Bulk Capacity  
Variable Pressure  
4 Claw Coupler  
Zinc With Black Rubber Grip

UNIT PACKAGE: 1

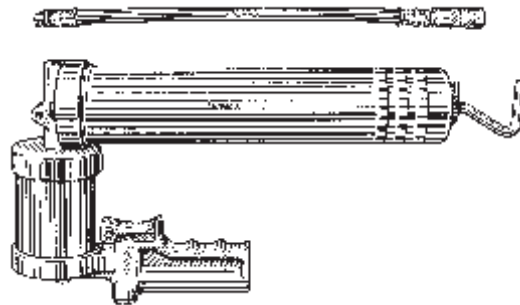

**16278**

Air Operated Grease Gun  
Pressure Ratio 50:1  
Required Air Pressure: 30-120 PSI.  
Suggested Working Air  
Pressure: 90 PSI  
3-Way Loading  
Use 14.5 oz. Cartridge  
16 oz. Bulk Capacity  
4 Claw Coupler  
Gray

UNIT PACKAGE: 1

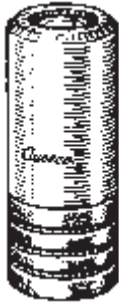

## 15688

Grease Gun Coupler  
With Ball Check

Fits 1/8" NPT Threads  
For hand operated lube equipment. Working pressure:  
3,000 PSI  
Overall Length: 1-3/8"

UNIT PACKAGE: 1

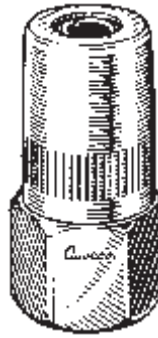

## 15689

Heavy Duty  
Grease Gun  
Coupler  
With Ball Check

Fits 1/8" NPT Threads  
For hand operated lube equipment only.  
Working pressure: 5,000 PSI  
Overall Length: 1-7/16"

UNIT PACKAGE: 1

## Grease Gun Hoses 1/8" NPT Male Fittings



## 15691

12"  
3000 PSI

UNIT PKG: 1

## 15692

18"  
3000 PSI

UNIT PKG: 1

## 16279

12"  
5800 PSI

UNIT PKG: 1

## 16280

18"  
5800 PSI

UNIT PKG: 1

## Grease Fitting Caps

Polyethylene caps that snap over fittings to seal out dirt and moisture. Integral ring keeps cap in place during servicing.



**18109**

Black

U.P. 50

**18110**

Red

U.P. 50

**18111**

Yellow

U.P. 50

## Square Drive Pipe Plug

Cold Rolled Steel



## 16307

Plain

3/8" Pipe Thread  
3/8" Square Drive  
Accommodates Standard 3/8" Drive Ratchet

UNIT PACKAGE: 10

## Hex Head Pipe Plugs

Cold Rolled Steel  
Plain Finish



Auveco  
Part No.

O.E.M.  
No.

Pipe  
Size

Unit  
Pkg.

**9278**.....GM: 444613 .....1/8-27 .....25

**9279**.....GM: 444619, .....1/4-18 .....25  
GM: 444620

**9280** .....3/8-18 .....25

**9281** .....1/2-14 .....25

## Socket Head Pipe Plugs

Cold Rolled Steel  
Plain Finish



Auveco  
Part No.

O.E.M.  
No.

Pipe  
Size

Unit  
Pkg.

**9282**.....GM: 9427882 .....1/8-27 .....25

**9283**.....GM: 444776 .....1/4-18 .....25

**9284**.....GM: 444782 .....3/8-18 .....25

**9285**.....GM: 444667, .....1/2-14 .....25  
GM: 444789

# Sec. 13

# BRASS FITTINGS

## Inverted Flare Fittings



Inverted Nut  
(Brass)

Auveco Part No.	Tube Size	Unit Pkg.
30	3/16"	10
31	1/4"	10
32	5/16"	10
33	3/8"	10
34	1/2"	10



Inverted Nut  
(Steel)

Auveco Part No.	Tube Size	Unit Pkg.
35	1/8"	10
36	3/16"	10
37	1/4"	10
38	5/16"	10
39	3/8"	10
40	1/2"	10



Steel Plug

Auveco Part No.	Tube Size	Unit Pkg.
45	3/16"	10
46	1/4"	10
47	5/16"	10



Sleeve (Brass)

Auveco Part No.	Tube Size	Unit Pkg.
101	1/8"	25
102	3/16"	25
103	1/4"	25
104	5/16"	25
105	3/8"	25
106	7/16"	10
107	1/2"	10
108	5/8"	10
109	3/4"	10



Union: (Brass)

Auveco Part No.	Tube Size	Unit Pkg.
150	1/8"	5
151	3/16"	5
152	1/4"	5
153	5/16"	5
154	3/8"	5
155	1/2"	5



Male Connector  
(Brass)

Auveco Part No.	Tube Size	Pipe Thread	Unit Pkg.
49	1/8"	1/8"	5
50	3/16"	1/8"	5
51	1/4"	1/8"	5
52	5/16"	1/8"	5
53	3/8"	1/4"	5
54	1/2"	3/8"	5



Union  
(Brass)

Auveco Part No.	Tube Size	Unit Pkg.
68	1/8"	5
69	3/16"	5
70	1/4"	5
72	3/8"	5
73	1/2"	5

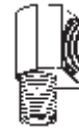

90° Male Elbow  
(Brass)

Auveco Part No.	Tube Size	Pipe Thread	Unit Pkg.
74	1/8"	1/8"	5
75	3/16"	1/8"	5
76	1/4"	1/8"	5
77	5/16"	1/8"	5
78	3/8"	1/4"	5
79	1/2"	3/8"	5



45° Male Elbow  
(Brass)

Auveco Part No.	Tube Size	Pipe Thread	Unit Pkg.
90	3/16"	1/8"	5
91	1/4"	1/8"	5

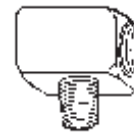

Male Branch  
(Brass)

Auveco Part No.	Tube Size	Pipe Thread	Unit Pkg.
96	3/16"	1/8"	5
97	1/4"	1/8"	5

## Compression Fittings



Nut  
(Brass)

Auveco Part No.	Tube Size	Unit Pkg.
110	1/8"	10
111	3/16"	10
112	1/4"	10
113	5/16"	10
114	3/8"	10
115	7/16"	10
116	1/2"	10

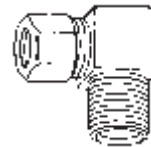

Male Elbow  
(Brass)

Auveco Part No.	Tube Size	Pipe Thread	Unit Pkg.
158	1/8"	1/8"	5
159	3/16"	1/8"	5
160	1/4"	1/8"	5
161	1/4"	1/4"	5
162	5/16"	1/8"	5
163	5/16"	1/4"	5
164	3/8"	1/8"	5
165	3/8"	1/4"	5
166	3/8"	3/8"	5
167	1/2"	3/8"	5
168	1/2"	1/2"	5

# BRASS FITTINGS

## Compression Fittings (continued)



Male Connector  
(Brass)

Auveco Part No.	Tube Size	Pipe Thread	Unit Pkg.
-----------------	-----------	-------------	-----------

119	1/8"	1/8"	5
120	3/16"	1/8"	5
121	1/4"	1/8"	5
122	1/4"	1/4"	5
123	5/16"	1/8"	5
124	5/16"	1/4"	5
125	3/8"	1/8"	5
126	3/8"	1/4"	5
127	3/8"	3/8"	5
128	1/2"	3/8"	5



Male Branch Tee  
(Brass)

Auveco Part No.	Tube Size	Pipe Thread	Unit Pkg.
-----------------	-----------	-------------	-----------

181	3/16"	1/8"	5
182	1/4"	1/8"	5
183	5/16"	1/8"	5
185	1/2"	3/8"	5



Female Connector  
(Brass)

Auveco Part No.	Tube Size	Pipe Thread	Unit Pkg.
-----------------	-----------	-------------	-----------

134	1/8"	1/8"	5
135	3/16"	1/8"	5
136	1/4"	1/8"	5
137	5/16"	1/8"	5



Male Run Tee  
(Brass)

Auveco Part No.	Tube Size	Pipe Thread	Unit Pkg.
-----------------	-----------	-------------	-----------

172	1/4"	1/8"	5
173	5/16"	1/8"	5



Adapter Tee  
(Brass)

Auveco Part No.	Tube Size	Ext. Pipe Thd.	Int. Pipe Thd.
-----------------	-----------	----------------	----------------

177	3/16"	1/8"	1/8"
178	1/4"	1/8"	1/8"

UNIT PACKAGE: 5

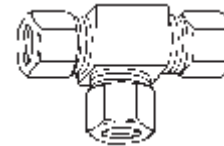

Union Tee  
(Brass)

Auveco Part No.	Tube Size	Unit Pkg.
-----------------	-----------	-----------

186	3/16"	5
187	1/4"	5
188	5/16"	5
189	3/8"	5

For an Assortment of Compression Fittings, see Fix-Kit No. 6119.

## Double Compression (Threaded Sleeve) Fittings



Nut  
(Brass)

Auveco Part No.	Tube Size	Unit Pkg.
-----------------	-----------	-----------

192	1/8"	10
193	3/16"	10
194	1/4"	10



Male Connector  
(Brass)

Auveco Part No.	Tube Size	Pipe Thread	Unit Pkg.
-----------------	-----------	-------------	-----------

198	1/8"	1/8"	5
199	3/16"	1/8"	5
200	1/4"	1/8"	5
201	5/16"	1/8"	5

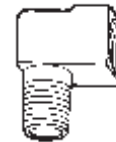

Male Elbow  
(Brass)

Auveco Part No.	Tube Size	Pipe Thread	Unit Pkg.
-----------------	-----------	-------------	-----------

205	1/8"	1/8"	5
206	3/16"	1/8"	5
207	1/4"	1/8"	5
208	5/16"	1/8"	5

## S.A.E. 45° Flared Tube Fittings



SE Flare Nut (Long)  
(Brass)

Auveco Part No.	Tube Size	Unit Pkg.
-----------------	-----------	-----------

211	3/16"	5
212	1/4"	5
213	5/16"	5
214	3/8"	5



SE Flare Nut (Short)  
(Brass)

Auveco Part No.	Tube Size	Unit Pkg.
-----------------	-----------	-----------

219	1/8"	5
221	1/4"	5
222	5/16"	5
223	3/8"	5
224	1/2"	5



Male Elbow  
(Brass)

Auveco Part No.	Tube Size	Pipe Thread	Unit Pkg.
-----------------	-----------	-------------	-----------

228	1/8"	1/8"	5
229	3/16"	1/8"	5
230	1/4"	1/8"	5
231	1/4"	1/4"	5
232	5/16"	1/8"	5
233	5/16"	1/4"	5
234	3/8"	1/4"	5
235	3/8"	1/8"	5
236	3/8"	3/8"	5

# Sec. 13

# BRASS FITTINGS

## S.A.E. 45° FLARED TUBE FITTINGS (continued)



Union  
(Brass)

Auveco Part No.	Tube Size	Unit Pkg.
243	3/16"	5
244	1/4"	5
245	5/16"	5
246	3/8"	5
247	1/2"	5

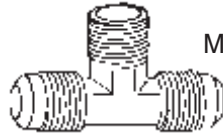

Male Branch Tee  
(Brass)

Auveco Part No.	Tube Size	Pipe Thread	Unit Pkg.
277	3/16"	1/8"	5
278	1/4"	1/8"	5
280	3/8"	1/4"	5



Elbow - Union  
(Brass)

Auveco Part No.	Tube Size	Unit Pkg.
273	1/4"	5



Male Connector  
(Brass)

Auveco Part No.	Tube Size	Pipe Thread	Unit Pkg.
260	3/16"	1/8"	5
261	1/4"	1/8"	5
262	1/4"	1/4"	5
263	5/16"	1/8"	5
264	5/16"	1/4"	5
265	3/8"	1/4"	5
266	3/8"	1/8"	5
267	3/8"	3/8"	5
268	1/2"	3/8"	5
269	1/2"	1/2"	5

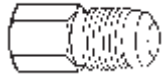

Female Connector  
(Brass)

Auveco Part No.	Tube Size	Pipe Thread	Unit Pkg.
250	3/16"	1/8"	5
251	1/4"	1/8"	5
252	1/4"	1/4"	5
253	5/16"	1/8"	5
254	5/16"	1/4"	5
255	3/8"	1/4"	5
256	3/8"	1/8"	5

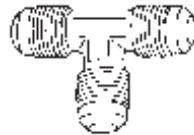

Union Tee  
(Brass)

Auveco Part No.	Tube Size	Unit Pkg.
284	1/4"	5

## Pipe Fittings



Cap  
(Brass)

Auveco Part No.	Pipe Thread	Unit Pkg.
287	1/8"	5
288	1/4"	5



Slotted Plug  
(Brass)

Auveco Part No.	Pipe Thread	Unit Pkg.
289	1/8"	5
290	1/4"	5



Square Head Plug  
(Brass)

Auveco Part No.	Pipe Thread	Unit Pkg.
291	1/8"	5
292	1/4"	5
293	3/8"	5
294	1/2"	5



Hex Head Plug  
(Brass)

Auveco Part No.	Pipe Thread	Unit Pkg.
295	1/8"	5
296	1/4"	5
297	3/8"	5
298	1/2"	5



Bushing  
(Brass)

Auveco Part No.	Ext. Pipe Thd.	Int. Pipe Thd.	Unit Pkg.
299	1/4"	1/8"	5
300	3/8"	1/8"	5
301	3/8"	1/4"	5
302	1/2"	1/8"	5
303	1/2"	1/4"	5
304	1/2"	3/8"	5

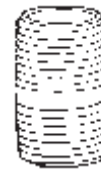

Close Nipple  
(Brass)

Auveco Part No.	Lgth.	Pipe Thread	Unit Pkg.
305	3/4"	1/8"	5
306	7/8"	1/4"	5
307	1"	3/8"	5
308	1-1/8"	1/2"	5



Long Nipple  
(Brass)

Auveco Part No.	Lgth.	Pipe Thread	Unit Pkg.
309	1-1/2"	1/8"	5
310	2"	1/8"	5
311	2-1/2"	1/8"	5
312	3"	1/8"	5
313	1-1/2"	1/4"	5
314	2"	1/4"	5
315	2-1/2"	1/4"	5

Refer to page 231 for "Pipe Thread Identification"

**BRASS FITTINGS**

**Pipe Fittings (continued)**



**Hex Nipple (Brass)**

Auveco Part No.	Pipe Thd. A	Pipe Thd. B	Unit Pkg.
316	1/8"	1/8"	5
317	1/4"	1/4"	5
318	1/4"	1/8"	5
319	3/8"	3/8"	5
320	3/8"	1/8"	5
321	3/8"	1/4"	5
322	1/2"	1/2"	5



**Union (Brass)**

Auveco Part No.	Pipe Thread	Unit Pkg.
340	1/8"	5
341	1/4"	5



**Cross (Brass)**

Auveco Part No.	Pipe Thread	Unit Pkg.
353	1/8"	5
354	1/4"	5

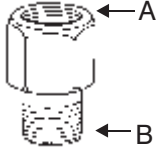

**Adaptor (Brass)**

Auveco Part No.	Pipe Thd. A	Pipe Thd. B	Unit Pkg.
325	1/8"	1/8"	5
326	1/4"	1/8"	5
327	1/4"	1/4"	5
328	3/8"	1/4"	5
329	3/8"	3/8"	5
330	1/2"	3/8"	5



**90° Street Elbow (Brass)**

Auveco Part No.	Int. Pipe Thd.	Ext. Pipe Thd.	Unit Pkg.
342	1/8"	1/8"	5
343	1/4"	1/4"	5
344	3/8"	3/8"	5
345	1/4"	1/8"	5



**Tee (Brass)**

Auveco Part No.	Pipe Thread	Unit Pkg.
355	1/8"	5
356	1/4"	5
357	3/8"	5



**Coupling (Brass)**

Auveco Part No.	Pipe Thread	Unit Pkg.
331	1/8"	5
332	1/4"	5
333	3/8"	5
334	1/2"	5

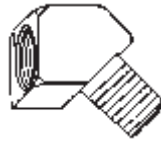

**45° Street Elbow (Brass)**

Auveco Part No.	Pipe Thread	Unit Pkg.
347	1/8"	5
348	1/4"	5
349	3/8"	5

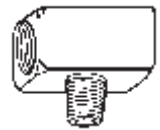

**Male Branch Tee (Brass)**

Auveco Part No.	Pipe Thread	Unit Pkg.
358	1/8"	5

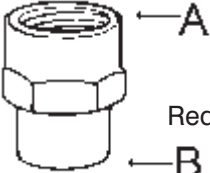

**Reducing Coupling (Brass)**

Auveco Part No.	Pipe Thd. A	Pipe Thd. B	Unit Pkg.
335	1/4"	1/8"	5
336	3/8"	1/8"	5
337	3/8"	1/4"	5
339	1/2"	3/8"	5



**90° Pipe Elbow (Brass)**

Auveco Part No.	Int. Pipe Thd.	Ext. Pipe Thd.	Unit Pkg.
350	1/8"	1/8"	5
351	1/4"	1/4"	5
352	3/8"	3/8"	5



**Street Tee (Brass)**

Auveco Part No.	Pipe Thread	Unit Pkg.
359	1/8"	5
360	1/4"	5

**Pipe Thread Identification**

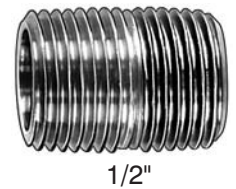
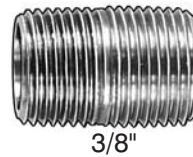
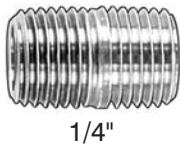

# Sec. 13

# BRASS FITTINGS

## Drain Cocks and Valves



External Seat  
(Brass)

Auveco Part No.	Pipe Thread	Unit Pkg.
370	1/8"	5
371	1/4"	5
372	3/8"	5

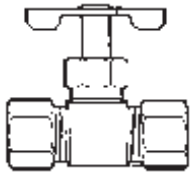

Compression Line  
(Brass)

Auveco Part No.	Tube Size	Unit Pkg.
385	1/4"	3
386	5/16"	3

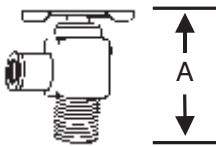

Angle Bib Drain  
(Brass)

Auveco Part No.	Pipe Thd.	A	Unit Pkg.
374	1/4"	1-11/16"	5

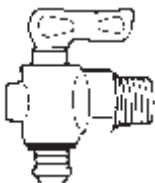

Ground Plug Drain  
(Brass)

Auveco Part No.	Pipe Thread	Unit Pkg.
405	1/8"	5
406	1/4"	5
407	3/8"	5

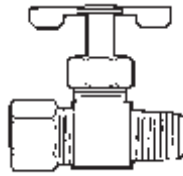

Compression Straightway  
(Brass)

Auveco Part No.	Tube Size	Pipe Thd.	Unit Pkg.
412	3/8"	1/4"	5

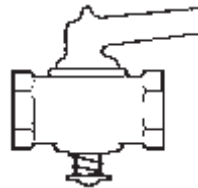

Female Pipe  
Ground Plug Line  
(Brass)

Auveco Part No.	Pipe Thread	Unit Pkg.
399	1/8"	3
401	1/4"	3

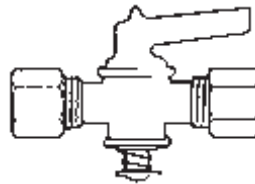

Compression Line  
Ground Plug  
(Brass)

Auveco Part No.	Tube Size	Unit Pkg.
389	5/16"	3



SE Straightway  
(Ground Plug)  
(Brass)

Auveco Part No.	Tube Size	Pipe Thd.	Unit Pkg.
394	3/8"	1/4"	3

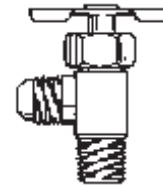

SE Angle  
(Brass)

Auveco Part No.	Tube Size	Pipe Thd.
395	1/4"	1/8"
398	3/8"	1/4"

UNIT PACKAGE: 3



Multiple Shut-Off Valves  
Stem Short  
(Brass)

Auveco Part No.	Desc.
404	3 Way 1/4 Female 3 Ends

UNIT PACKAGE: 1



# BRASS FITTINGS

## Sec. 13



Ball End  
Joint Adapter To  
Taper Male Pipe

Auveco Part No.	Male N.P.S. Thread	Male N.P.T. Thread	Unit Pkg.
445	1/4"	1/4"	10
447	3/8"	3/8"	5
448	1/2"	3/8"	5

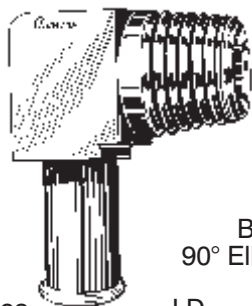

Beaded Hose Barb  
90° Elbow Tube To Male Pipe

Auveco Part No.	I.D. Hose Size	Pipe Thread	Unit Pkg.
461	1/2"	3/8"	3
462	5/8"	1/4"	3
463	5/8"	3/8"	3
464	5/8"	1/2"	3
465	3/4"	1/2"	2

Beaded Hose Barb  
Tube To Male Pipe



Auveco Part No.	I.D. Hose Size	Pipe Thread	Unit Pkg.
413	3/8"	3/8"	5
414	1/2"	1/4"	5
415	1/2"	3/8"	5
416	5/8"	3/8"	5
417	5/8"	1/2"	5
418	3/4"	1/2"	5



Hose Barb To  
Taper Male Pipe

Auveco Part No.	I.D. Hose Size	Pipe Thread	Unit Pkg.
424	3/16"	1/8"	10
425	1/4"	1/8"	10
426	1/4"	1/4"	10
427	1/4"	3/8"	5
428	5/16"	1/8"	10
429	5/16"	1/4"	5
430	3/8"	1/8"	10
431	3/8"	1/4"	10
432	3/8"	3/8"	5
433	1/2"	1/4"	5
434	1/2"	3/8"	5
435	1/2"	1/2"	5



Barbed Hose Coupler

Auveco Part No.	I.D. Hose Size	Overall Length	Unit Pkg.
*419	3/16"	1.44"	5
420	1/4"	2.00"	5
421	5/16"	2.00"	5
422	3/8"	2.00"	5
423	1/2"	2.00"	5

\* 3 Barb Design



Hose Barb To  
Taper Female Pipe

Auveco Part No.	I.D. Hose Size	Pipe Thread	Unit Pkg.
437	1/4"	1/4"	5
438	5/16"	1/4"	5
439	3/8"	1/8"	5
440	3/8"	1/4"	5
441	3/8"	3/8"	5
442	1/2"	3/8"	5
443	1/2"	1/2"	5



Hose Barb 90° Elbow  
Tube To Male Pipe

Auveco Part No.	I.D. Hose Size	Pipe Thread	Unit Pkg.
455	1/4"	1/8"	5
456	1/4"	1/4"	5
457	3/8"	1/4"	5

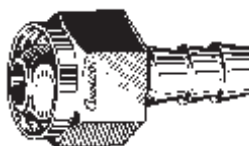

Hose Barb To  
Swivel Female Ball End

Auveco Part No.	I.D. Hose Size	Female N.P.S. Thd.	Unit Pkg.
454	1/2"	1/2"	5

**RIVETS**



**Brazier Head  
Solid Aluminum Rivets**

Auveco Part No.	Dia.	Length	Head Dia.	Unit Pkg.
9643	3/16"	3/8"	15/32"	100
9644	3/16"	3/8"	15/32"	1000
12528	3/16"	1/2"	15/32"	100
12529	3/16"	1/2"	15/32"	1000
9647	1/4"	3/8"	5/8"	100
9648	1/4"	3/8"	5/8"	1000

**Refer To Page 260 For Drill Bits Used With Rivets**



**Pan'1 Blind Rivets**



Dome Head

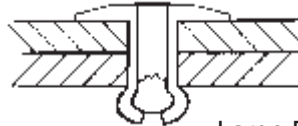

Large Flange



Countersunk

Auveco Part No. Unit Package Quantity					Head (Flange) Type & Diameter	Rivet Dia.	Grip Range	Rivet Length Exc. Flange	Cross Reference		
25	50	100	500	1000					POP®	Marson Klik-Fast	
<b>Steel Rivet - Steel Mandrel - Plated</b>											
—	—	<b>19044</b>	—	—	Dome	3/16"	3/32"	1/32" - 1/8"	15/64"	SD32BS	SB3-2
—	—	<b>19045</b>	—	—	Dome	3/16"	3/32"	1/8" - 1/4"	23/64"	SD34BS	SB3-4
—	—	<b>19046</b>	—	—	Dome	1/4"	1/8"	1/32" - 1/16"	13/64"	SD41BS	SB4-1
—	—	<b>5749</b>	<b>5748</b>	<b>8871</b>	Dome	1/4"	1/8"	1/16" - 1/8"	7/32"	SD42BS	SB4-2
—	—	<b>5751</b>	<b>5750</b>	<b>8872</b>	Cntrsnsk	7/32"	1/8"	1/16" - 1/8"	7/32"	SK42BS	SC4-2
—	—	<b>8291</b>	<b>8290</b>	<b>8873</b>	Lg Flange	3/8"	1/8"	1/16" - 1/8"	7/32"	SD42BSLF	SBL4-2
—	—	<b>8874</b>	<b>8875</b>	—	Dome	1/4"	1/8"	1/8" - 3/16"	5/16"	SD43BS	SB4-3
—	—	<b>5753</b>	<b>5752</b>	<b>8877</b>	Dome	1/4"	1/8"	3/16" - 1/4"	25/64"	SD44BS	SB4-4
—	—	<b>8303</b>	<b>8302</b>	—	Cntrsnsk	7/32"	1/8"	3/16" - 1/4"	25/64"	SK44BS	SC4-4
—	—	<b>8293</b>	<b>8292</b>	<b>8879</b>	Lg Flange	3/8"	1/8"	3/16" - 1/4"	25/64"	SD44BSLF	SBL4-4
—	—	<b>8880</b>	<b>8881</b>	<b>8882</b>	Dome	1/4"	1/8"	5/16" - 3/8"	1/2"	SD46BS	SB4-6
—	—	<b>19047</b>	—	—	Dome	1/4"	1/8"	3/8" - 1/2"	41/64"	SD48BS	SB4-8
—	—	<b>8883</b>	<b>8884</b>	—	Dome	5/16"	5/32"	1/16" - 1/8"	7/32"	SD52BS	SB5-2
—	—	<b>8886</b>	<b>8887</b>	<b>8888</b>	Dome	5/16"	5/32"	3/16" - 1/4"	3/8"	SD54BS	SB5-4
—	—	<b>8889</b>	—	—	Dome	3/8"	3/16"	1/16" - 1/8"	9/32"	SD62BS	SB6-2
—	—	<b>8892</b>	<b>8893</b>	<b>8894</b>	Dome	3/8"	3/16"	1/8" - 1/4"	7/16"	SD64BS	SB6-4
—	<b>18811</b>	—	—	—	Lg Flange	5/8"	3/16"	1/8" - 1/4"	7/16"	SD64BSLF	SBL6-4
—	—	<b>8895</b>	<b>8896</b>	<b>8897</b>	Dome	3/8"	3/16"	1/4" - 3/8"	9/16"	SD66BS	SB6-6
—	—	<b>8305</b>	<b>8304</b>	<b>8898</b>	Lg Flange	5/8"	3/16"	1/4" - 3/8"	9/16"	SD66BSLF	SBL6-6
—	—	<b>8899</b>	<b>8900</b>	<b>8901</b>	Dome	3/8"	3/16"	3/8" - 1/2"	11/16"	SD68BS	SB6-8
—	<b>18812</b>	—	—	—	Lg Flange	5/8"	3/16"	3/8" - 1/2"	11/16"	SD68BSLF	SBL6-8
—	—	<b>8902</b>	<b>8903</b>	—	Dome	3/8"	3/16"	1/2" - 5/8"	13/16"	SD610BS	SB6-10
<b>18813</b>	—	—	—	—	Lg Flange	5/8"	3/16"	1/2" - 5/8"	13/16"	SD610BSLF	SBL6-10
<b>18814</b>	—	—	—	—	Lg Flange	5/8"	3/16"	5/8" - 3/4"	15/16"	SD612BSLF	SBL6-12
<b>19896</b>	—	—	—	—	Dome	1/2"	1/4"	3/8" - 1/2"	23/32"	SD88BS	SB8-8
<b>19048</b>	—	—	—	—	Dome	1/2"	1/4"	3/4" - 1"	1-15/64"	SD816BS	—

# PAN'L BLIND RIVETS (Cont.)

**Sec. 14**

Auveco Part No. Unit Package Quantity					Head (Flange) Type & Diameter	Rivet Dia.	Grip Range	Rivet Length Exc. Flange	Cross Reference		
25	50	100	500	1000					POP®	Marson Klik-Fast	
<b>Aluminum Rivet - Steel Mandrel</b>											
—	—	8905	8906	8907	Dome 1/4"	1/8"	1/16" - 1/8"	7/32"	AD42BS	AB4-2	
—	—	8908	8909	—	Cntrs nk 7/32"	1/8"	1/16" - 1/8"	7/32"	AK42BS	AC4-2	
—	—	8911	8912	8913	Dome 1/4"	1/8"	3/16" - 1/4"	3/8"	AD44BS	AB4-4	
—	—	8914	8915	—	Cntrs nk 7/32"	1/8"	3/16" - 1/4"	3/8"	AK44BS	AC4-4	
—	—	19049	—	—	Dome 1/4"	1/8"	3/8" - 1/2"	41/64"	AD48BS	AB4-8	
—	—	19050	—	—	Dome 5/16"	5/32"	3/16" - 1/4"	27/64"	AD54BS	AB5-4	
—	—	8295	8294	8917	Dome 3/8"	3/16"	1/16" - 1/8"	9/32"	AD62BS	AB6-2	
—	—	8307	8306	8918	Dome 3/8"	3/16"	1/8" - 1/4"	3/8"	AD64BS	AB6-4	
—	—	8297	8296	8919	Dome 3/8"	3/16"	1/4" - 3/8"	9/16"	AD66BS	AB6-6	
—	19051	—	—	—	Lg Flange 5/8"	3/16"	3/8" - 1/2"	11/16"	AD68BSLF	ABL6-8	
<b>Aluminum Rivet - Aluminum Mandrel</b>											
—	—	19053	—	—	Dome 3/16"	3/32"	1/32" - 1/8"	15/64"	AD32ABS	AB3-2A	
—	—	8309	8308	8920	Dome 1/4"	1/8"	1/16" - 1/8"	7/32"	AD42ABS	AB4-2A	
—	—	8299	8298	—	Cntrs nk 7/32"	1/8"	1/16" - 1/8"	7/32"	AK42ABS	AC4-2A	
—	—	8922	8923	8924	Lg Flange 3/8"	1/8"	1/16" - 1/8"	7/32"	AD42ABSLF	ABL4-2A	
—	—	8925	8926	8927	Dome 1/4"	1/8"	3/16" - 1/4"	3/8"	AD44ABS	AB4-4A	
—	—	8928	8929	8930	Cntrs nk 7/32"	1/8"	3/16" - 1/4"	3/8"	AK44ABS	AC4-4A	
—	—	8931	8932	8933	Lg Flange 3/8"	1/8"	3/16" - 1/4"	3/8"	AD44ABSLF	ABL4-4A	
—	—	16031	—	—	Dome 1/4"	1/8"	5/16" - 3/8"	1/2"	AD46ABS	AB4-6A	
—	—	16032	—	—	Dome 1/4"	1/8"	3/8" - 1/2"	5/8"	AD48ABS	AB4-8A	
—	—	20474	—	—	Lg. Flange 3/8"	1/8"	3/8" - 1/2"	5/8"	—	ABL4-8A	
—	—	18727	—	—	Dome 5/16"	5/32"	1/16" - 1/8"	9/32"	AD52ABS	AB5-2A	
—	—	18728	—	—	Dome 5/16"	5/32"	1/8" - 3/16"	11/32"	AD53ABS	AB5-3A	
—	—	18729	—	—	Dome 5/16"	5/32"	3/16" - 1/4"	13/32"	AD54ABS	AB5-4A	
—	18732	—	—	—	Lg Flange 15/32"	5/32"	3/16" - 1/4"	13/32"	AD54ABSLF	—	
—	—	18730	—	—	Dome 5/16"	5/32"	1/4" - 3/8"	1/2"	AD56ABS	AB5-6A	
—	18731	—	—	—	Dome 5/16"	5/32"	3/8" - 1/2"	5/8"	AD58ABS	AB5-8A	
—	—	5755	5754	8934	Dome 3/8"	3/16"	1/16" - 1/8"	9/32"	AD62ABS	AB6-2A	
—	—	8311	8310	8935	Dome 3/8"	3/16"	1/8" - 1/4"	7/16"	AD64ABS	AB6-4A	
—	19055	—	—	—	Lg Flange 5/8"	3/16"	1/8" - 1/4"	7/16"	AD64ABSLF	ABL6-4A	
—	—	8301	8300	8936	Dome 3/8"	3/16"	1/4" - 3/8"	9/16"	AD66ABS	AB6-6A	
—	—	8313	8312	8937	Lg Flange 5/8"	3/16"	1/4" - 3/8"	9/16"	AD66ABSLF	ABL6-6A	
—	—	8938	8939	8940	Dome 3/8"	3/16"	3/8" - 1/2"	11/16"	AD68ABS	AB6-8A	
—	19056	—	—	—	Lg Flange 5/8"	3/16"	3/8" - 1/2"	11/16"	AD68ABSLF	ABL6-8A	
—	—	18489	—	—	Dome 3/8"	3/16"	1/2" - 5/8"	13/16"	AD610ABS	AB6-10A	
19057	—	—	—	—	Lg Flange 5/8"	3/16"	1/2" - 5/8"	13/16"	AD610ABSL F	ABL6-10 A	
19058	—	—	—	—	Dome 1/2"	1/4"	1/4" - 3/8"	39/64"	AD86ABS	AB8-6A	
<b>Stainless Steel Rivet - Stainless Steel Mandrel</b>											
—	19059	—	—	—	Dome 1/4"	1/8"	1/8" - 3/16"	21/64"	SSD43SSBS	SSB4-3S	
—	19060	—	—	—	Dome 1/4"	1/8"	3/16" - 1/4"	25/64"	SSD44SSBS	SSB4-4S	
19061	—	—	—	—	Dome 3/8"	3/16"	3/8" - 1/2"	11/16"	SSD68SSBS	SSB6-8S	
<b>Stainless Steel Rivet - Steel Mandrel</b>											
Replaces Ford No.: 383229-S											
To replace welded studs on body. (Use Auveco Rivet Gun No. 7915 w/ No. 7981 Nose Piece.)											
—	—	11104	11105	11106	Sm. Flange 3/16"	1/8"	3/16" - 1/4"	5/16"	R4357	SSBN4-3	

**RIVET GUNS & ACCESSORIES**

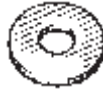

**Steel Rivet Washers**

Zinc

**16791**

For 1/8" Dia.  
1/2" O.D.

U.P.: 100

**15973**

For 5/32" Dia.  
1/2" O.D.

U.P.: 100

**16792**

For 3/16" Dia.  
15/32" O.D.

U.P.: 100

**RIVET GUNS & ACCESSORIES**

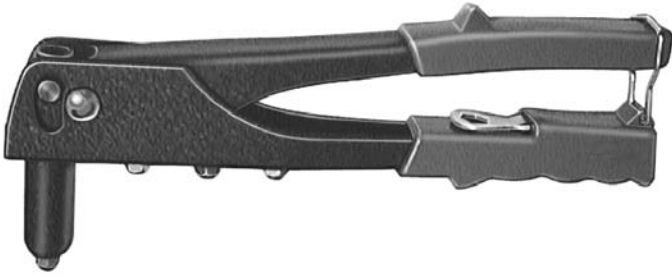

**19234**

Economy Rivet Gun  
With 3/32", 1/8", 5/32" and 3/16"  
nose pieces. Overall Length: 10"  
Replacement accessories are not available

UNIT PACKAGE: 1



**19494**

Ergonomic Rivet Gun  
30 to 1 mechanical advantage makes it  
50% easier to use than other rivet guns.  
Includes 3/32", 1/8", 5/32" & 3/16"  
nose pieces for setting conventional rivets.  
Innovative latch design keeps handles closed  
without cumbersome chains or wires.

UNIT PACKAGE: 1

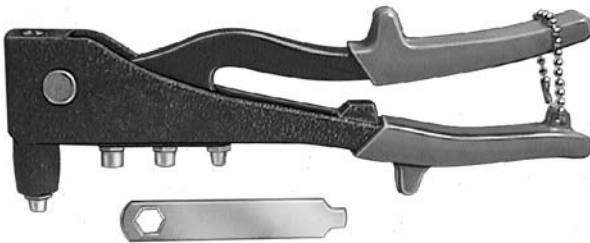

**7915**

Pan'l Rivet Gun  
with 3/32", 1/8", 5/32" and 3/16" nose pieces  
Overall Length: 9-1/2"

UNIT PACKAGE: 1



**19215**

Replacement Jaws  
For Auveco Rivet Gun  
7915

UNIT PKG. 1 Set



Nose Pieces  
For 7915 Rivet Gun

Auveco Part No.	Description	Unit Pkg.
<b>7981</b>	Use with 1/8" rivet 11104 to replace welded studs	1
<b>7982</b>	For 3/32" diameter rivets	1
<b>7983</b>	For 1/8" diameter rivets	1
<b>7984</b>	For 5/32" diameter rivets	1
<b>7985</b>	For 3/16" diameter rivets	1
<b>7986</b>	A set of one each of 7982, 7983, 7984 and 7985	1 Set



**11817**

Rivet gun for setting 3/16" & 1/4" rivets.  
Use to install "Peel-Type" Rivets  
Comes complete with 3/16" and 1/4" standard  
nose pieces plus a nose piece  
for 1/4" "peel type" rivets. 22" long.

UNIT PACKAGE: 1

**11817 Rivet Gun Accessories**



**19132**

Nose piece  
for 1/8"  
standard rivets  
UNIT PKG: 1



**19133**

Nose piece  
for 3/16"  
standard rivets  
UNIT PKG: 1



**19134**

Nose piece  
for 1/4"  
standard rivets  
UNIT PKG: 1



**11853**

Nose piece for  
1/4" "peel type"  
rivets.

UNIT PKG: 1



**14799**

Replacement jaws  
repair kit for rivet gun 11817

UNIT PKG: 1



**13808** For 3/16"  
**13809** For 1/4"

Nose pieces for setting  
Auveco Klamp-Tite Rivets with a  
**Pneumatic Tool.**

UNIT PKG: 1



**19066**

Rivet Gun  
With nose pieces for  
3/32", 1/8", 5/32", 3/16" & 1/4" diameter rivets.  
Overall Length: 21"

UNIT PACKAGE: 1



**17498**

11817 Rivet Gun Extender Nosepiece Adapter Kit  
To retrofit Auveco Rivet Gun 11817 with nosepiece  
that extends the reach by 2-1/2" for a total of 5".

UNIT PACKAGE: 1

# Sec. 14

## RIVET GUNS & ACCESSORIES 12087 Rivet Gun Tool & Accessories

### 12087

Gun for setting Monobolts and conventional Avex and Stavex rivets. Comes complete with nose pieces for 1/8", 3/16" and 1/4" Avex rivets and 3/16" Stavex® rivets. Requires Nose Pieces 13825 and 19622 to set Monobolts. Will not set "Peel-Type" rivets.

UNIT PACKAGE: 1



### 19622

Nose piece for 3/16" monobolts

UNIT PKG: 1



### 13825

Nose piece for 1/4" monobolts

UNIT PKG: 1



### 13829

Nose piece for 3/16" conventional rivets.

UNIT PKG: 1



### 14577

Replacement jaws repair kit for 12087 monobolt setting tool.

UNIT PACKAGE: 1



### 19377

Replacement Jaw Case Housing. For the repair of 12087 rivet guns which have been damaged due to attempted installation of improper rivets. 12087 should be used with the correct nose pieces only for setting Monobolts and Conventional Avex and Stavex rivets. It will *not* set "Peel-Type" rivets.

UNIT PACKAGE: 1

## PLASTIC RIVETS & GUNS



### 14155 Rivet Setter Gun (For Nylon Rivets)

For use with nylon blind rivets. An economical tool that provides the extra long pulling stroke needed to set nylon (plastic) rivets. It features all steel construction and full-size vinyl coated handles for smooth, easy operation. Not for use with metal rivets. 9-1/2" long

UNIT PACKAGE: 1



### 13756 Rivet Setter Gun (For Nylon Rivets)

For use with nylon (plastic) blind rivets. A durable tool that sets all sizes with a single stroke. All steel construction. Not for use with metal rivets. 6-1/2" long.

UNIT PACKAGE: 1

**THE RIVET CONNECTION**

The "Easy to Choose - Easy to Use" Rivet Program  
 "The Packaged Quantity You Want"



The Rivet Connection offers a rivet program whose time has come. The unique flexibility of the merchandising concept makes it the ideal program. While it's designed for the retail/walk-in business at the jobber store, IT IS ALSO THE PERFECT SYSTEM FOR THE MOBILE DISTRIBUTOR THAT CALLS ON AND SERVICES BODY SHOPS DIRECTLY.

The program is built upon our RC Paks which are 56 popular parts packaged in one-price clam shells. Every RC Pak is attractively labeled with a part number, number of pieces, O.E.M. numbers, all the necessary dimensional specifications and is UPC bar coded.

The RC Paks are merchandised on two panel assortments - part number **RC103**. The panels give you the coverage you need in a system with a premium on space. Merchandising rivets has never been easier. The panels come "pre-dressed" with the RC Paks already hung in place. Simply lift a panel out of the shipping carton and mount the panel on a pegboard wall or gondola with the attached hooks. It's that quick and easy.

Each panel measures 16" Wide x 28-1/2" High and accommodates 28 different items. The looped product hooks are 4-3/4" long and will hold up to 5 RC Paks. Back-up labels with UPC bar codes make re-ordering replacement merchandise a snap while panel location information printed on each RC Pak label makes restocking just as quick and easy.

For complete information on The Rivet Connection program including individual RC Paks, request a Rivet Connection 4 page flyer when you place your next Auveco order.



RC Pak Assortment No. RC103 Includes  
 ← Panel # 1 And Panel # 2 →



- Open-End Blind Rivets
- Nylon Rivets
- Drill Bits
- Rivet Washer
- Jack Nuts®
- Well Nuts®

- Special Application Rivets
- GM
- Ford
- Chrysler

# Sec. 14

## RC-103 RC PAK PANEL ASSORTMENTS

### Part No. RC103

### RC Pak Panel Combo Assortment

Consists of 1 panel each of Panel 1 and Panel 2 as listed below. All (56) RC Pak Numbers are included.

#### Panel #1 Assortment of Open-End Blind Rivets, Nylon Rivets, Rivet Accessories, Jack Nuts and Well Nuts

Contains (3) paks each of the (28) part numbers listed below:

53117	1/8" Medium; Steel	53658	Rivet Washer For 1/8" Diameter	58151	1/4" Dia.; 5/32"-13/32"
53121	1/8" Long, Steel	53661	For 3/16" Diameter	58185	17/64" Dia.; 3/32"-3/16"
53212	1/8" Short, Aluminum		<b>Drill Bits</b>	58186	17/64" Dia.; 3/32"-3/16"
53217	1/8" Medium, Aluminum	53670	.125" x 2"	58289	15/64" Dia.; 5/32"-5/16"
53219*	1/8" Medium, Aluminum		<b>Nylon Rivets</b>		<b>Jack Nuts®</b>
53221	1/8" Long, Aluminum	58105	13/64" Dia.; 1/16"-11/64"	91005	1/4"-20
53245	3/16" Short; Aluminum	58106	13/64" Dia.; 1/8"-15/64"	91013	1/4"-20 w/Sealer
53247	3/16" Medium; Aluminum	58107	13/64" Dia.; 1/8"-3/16"	91017	M6-1.0 w/Raintite
53249	3/16" Long; Aluminum	58108	13/64" Dia.; 15/64"-25/64"		<b>Well Nuts®</b>
53250*	3/16" Long; Aluminum	58130	15/64" Dia.; 11/64"-11/32"	91060	1/4"-20, Short
* Large Flange		58150	1/4" Dia.; 5/32"-13/32"	91062	1/4"-20, Long

#### Panel #2 Assortment of Special Application Rivets

Contains (3) paks each of the (28) part numbers listed below:

52371	GM, Ford, Chry.	52378	Ford	53308	Ford	53328	Ford
52372	GM, Ford	52380	GM, Ford	53309	VW	53329	Ford, Chry.
52373	GM	53150	GM	53310	GM	53331	GM
52374	GM, Chry.	53222	Universal	53313	GM	53353	GM, Chry.
52375	Ford	53256	Chry.	53316	GM, Ford	53516	Ford
52376	GM, Ford, Chry.	53303	Ford	53321	Ford	56022	Ford
52377	GM	53304	Ford	53323	Ford	58086	Ford

**Note: All refill RC Paks come (5) Paks in a poly bag i.e. one unit of any RC Pak number equals (5) individual RC Paks**

### RC PAK TO AUVECO CROSS REFERENCE

RC Pak No.	Auveco Unit Pkg. Part No.	RC Pak No.	Auveco Unit Pkg. Part No.	RC Pak No.	Auveco Unit Pkg. Part No.
52371	11620	53249	8301	53670	9316
52372	11852	53250	8313	56022	17410
52373	15684	53256	16940	58086	15187
52374	12655	53303	16834	58105	13747
52375	12653	53304	18304	58106	13748
52376	11621	53308	18461	58107	13754
52377	14106	53309	17006	58108	13755
52378	18167	53310	17177	58130	14004
52380	12658	53313	16864	58150	13750
53117	5753	53316	17121	58151	13751
53121	8880	53321	14127	58185	13752
53150	12657	53323	18331	58186	13753
53212	8309	53328	12652	58289	14023
53217	8925	53329	17639	91005	13016
53219	8931	53331	18170	91013	12995
53221	16031	53353	16687	91017	12999
53222	16032	53516	11104	91060	13004
53245	5755	53658	16791	91062	13010
53247	8311	53661	16792		



# POP® MULTI-GRIP BLIND RIVETS

Functions In A Wide Range Of Material Thicknesses



The Multi-Grip rivet will serve in applications where solid and soft materials and thicknesses normally require several rivet sizes. Oversize, irregular or misaligned holes are automatically compensated for by the self-adjusting hole-filling capability. The mandrel head is retained in the rivet body, forming a tight, weather resistant seal.

Auveco Part No.	Head Style & Diameter		Rivet Dia.	Hole Size	Grip Range	Rivet Length Excluding Flange	Unit Pkg.	POP® No.
<b>Aluminum Rivet, Steel Mandrel</b>								
18742	Dome	1/4"	1/8"	.129"-.142"	1/32"-3/16"	21/64"	100	AD41-43BS
19033	Large Flange	3/8"	1/8"	.129"-.142"	1/32"-3/16"	21/64"	100	AD41-43BSLF
19025	Dome	1/4"	1/8"	.129"-.142"	5/32"-5/16"	15/32"	100	AD43-45BS
19034	Large Flange	3/8"	1/8"	.129"-.142"	5/32"-5/16"	15/32"	100	AD43-45BSLF
19026	Dome	1/4"	1/8"	.129"-.142"	1/4"-7/16"	39/64"	100	AD45-47BS
18743	Dome	5/16"	5/32"	.160"-.173"	3/64"-1/4"	13/32"	100	AD52-54BS
17468	Large Flange	15/32"	5/32"	.160"-.173"	3/64"-1/4"	13/32"	50	AD52-54BSLF
19027	Dome	5/16"	5/32"	.160"-.173"	1/8"-5/16"	1/2"	50	AD53-55BS
18744	Dome	3/8"	3/16"	.192"-.205"	1/16"-1/4"	7/16"	50	AD62-64BS
19036	Large Flange	5/8"	3/16"	.192"-.205"	1/16"-1/4"	7/16"	50	AD62-64BSLF
19028	Dome	3/8"	3/16"	.192"-.205"	3/16"-3/8"	5/8"	50	AD63-66BS
19029	Dome	3/8"	3/16"	.192"-.205"	1/4"-1/2"	47/64"	50	AD66-68BS
19037	Large Flange	5/8"	3/16"	.192"-.205"	1/4"-1/2"	47/64"	50	AD66-68BSLF
19030	Dome	3/8"	3/16"	.192"-.205"	7/16"-3/4"	1-1/16"	50	AD68-612BS
19031	Dome	1/2"	1/4"	.261"-.275"	5/64"-11/32"	39/64"	25	AD82-86BS
<b>Aluminum Rivet, Stainless Steel Mandrel</b>								
19038	Dome	3/8"	3/16"	.192"-.205"	1/16"-1/4"	7/16"	50	AD62-64SSBS
19040	Large Flange	5/8"	3/16"	.192"-.205"	1/16"-1/4"	7/16"	25	AD62-64SSBSLF
19039	Countersunk	11/32"	3/16"	.192"-.205"	3/16"-3/8"	9/16"	50	AK64-66SSBS
19041	Large Flange	5/8"	3/16"	.192"-.205"	1/8"-1/2"	47/64"	25	AD64-68SSBSLF

# Sec. 14

# AUTOMOTIVE O.E.M. NYLON BLIND RIVETS

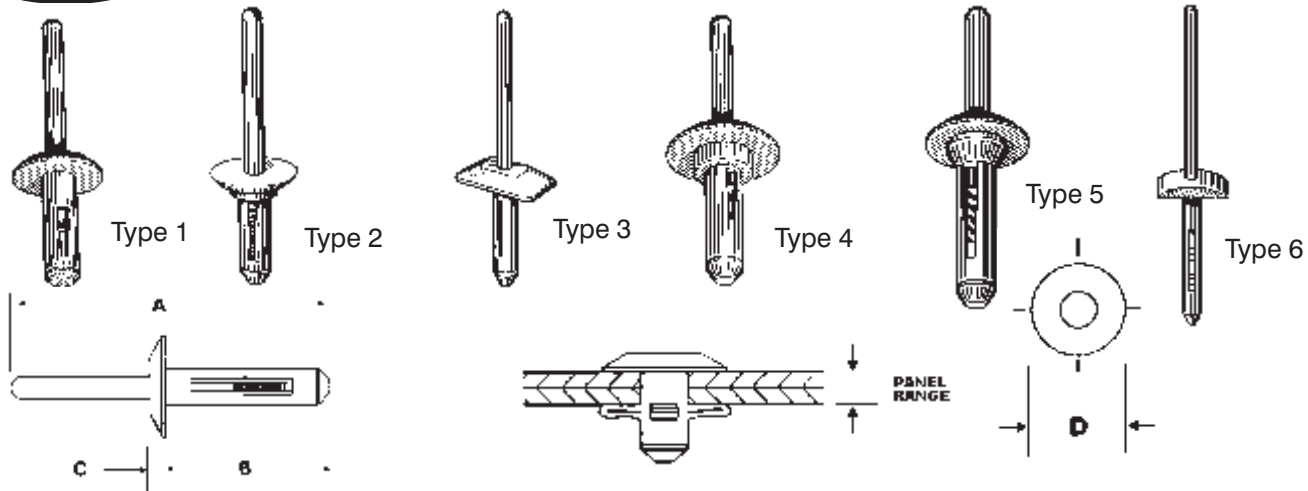

Auveco No.	Type	Color	O.E.M. Number	Hole Dia.	Panel Range (Grip)	A	B	C	D	Unit Pkg
17220	3	Black	GM: 21094747	5/32"	7/64"-7/32"	1-7/8"	3/4"	3/32"	**	50
15187	6	Black	Ford: N804583S	4mm	6mm-10.5mm	65mm	26mm	2.5mm	***	25
13746	1	Black	GM: 20612732	3/16"	1/16"-9/64"	1-7/8"	23/32"	3/32"	11/32"	25
18501	1	Black	Chry: 6502689	3/16"	5/32"-1/4"	1-27/32"	21/32"	1/16"	11/32"	25
13747	1	Black	GM: 20423647 Ford: N804189S	13/64"	1/16"-11/64"	1-7/8"	23/32"	1/8"	15/32"	25
14005	1	Black	GM: 20465395, Chry: 6004212	13/64"	1/8"-5/32"	1-13/16"	21/32"	1/16"	11/32"	25
13748	1	Black	GM: 20432975 VW: 175-853-57701C	13/64"	1/8"-15/64"	1-7/8"	25/32"	1/16"	15/32"	25
13754	1	Black	Chry: 6500859	13/64"	1/8"-3/16"	1-7/8"	25/32"	1/16"	15/32"	25
13755	1	Black	Chry: 6500898	13/64"	15/64"-25/64"	2"	1"	1/16"	15/32"	25
14004	1	Black	GM: 25524005	15/64"	11/64"-11/32"	2-3/64"	1-1/8"	3/32"	1/2"	25
14023	1	Black	GM: 10036503	15/64"	5/32"-5/16"	2-1/8"	1-5/32"	3/32"	5/8"	25
18913	1	Black	Chry: 6503938	15/64"	5/32"-9/32"	2-5/32"	1-1/16"	3/32"	1/2"	25
18028	2	Black	Chry: 4630088	1/4"	1/32"-11/64"	2-3/16"	13/16"	3/32"	21/32"	25
18031	2	Black*	Chry: 4630660	1/4"	1/32"-3/16"	2-1/8"	3/4"	3/32"	21/32"	25
15488	4	Black	GM: 10069112	1/4"	3/64"-5/32"	2-3/16"	15/16"	7/64"	13/16"	50
18242	5	Black	Chry: 6501509	1/4"	3/64"-3/16"	2-7/32"	1-1/8"	3/32"	25/32"	25
13749	1	White	GM: 14070914	1/4"	5/32"-15/64"	2-3/16"	23/32"	3/32"	21/32"	25
18502	1	Black	General Purpose	1/4"	5/32"-1/4"	2-3/16"	23/32"	3/32"	21/32"	25
15495	1	Black	Ford: N804472S AMC: 8934-202-078	1/4"	5/32"-9/32"	2-3/16"	1-1/8"	3/32"	1/2"	25
18108	1	Black	Chry: 34201631	1/4"	5/32"-3/8"	2-7/32"	1-1/8"	3/32"	11/16"	25
17496	1	Gray	AMC: 8934-201-835	1/4"	5/32"-3/8"	2-7/32"	1-1/8"	3/32"	11/16"	25
14012	1	White	GM: 15506827	1/4"	5/32"-13/32"	2"	1-1/8"	3/32"	21/32"	25
13751	1	Black	GM: 20452072 Ford: N803862-S Chry: 6501559	1/4"	5/32"-13/32"	2-3/16"	1-3/32"	3/32"	1/2"	25
13750	1	Black	GM: 14063981 Ford: N803043-S Chry: 6500911	1/4"	5/32"-13/32"	2-3/16"	1-3/32"	3/32"	21/32"	25
15491	1	Black	Ford: N804759-S	1/4"	19/64"-27/64"	2-1/8"	13/16"	3/32"	21/32"	25
17101	1	Black	Chry: 4370138, 6503860 Ford: N804675S	1/4"	5/16"-15/32"	2-9/32"	1-1/4"	3/32"	21/32"	25
13752	1	Black	GM: 20421672	17/64"	3/32"-3/16"	1-7/8"	25/32"	3/32"	1/2"	25
13753	1	Black	GM: 20433026 VW: 175-853-577A	17/64"	3/32"-3/16"	1-7/8"	25/32"	3/32"	23/32"	25
15490	1	Black	GM: 10109689, 12337915	9/32"	3/32"-15/64"	2-3/16"	15/16"	3/32"	23/32"	25

\* Black Rivet Body, White Mandrel

\*\* 5/16" x 19/32"

\*\*\*8.5mm x 15.5mm

Note: Use rivet guns 13756 or 14155 to install all of the above rivets.

# AVEX® BLIND RIVETS



## What Makes Avex® Different...And Better?

The Avex® rivet adds important... and exclusive...features to those offered by ordinary blind rivets. The unique advantages designed into the Avex® rivet allow for its use:

**In wide-tolerance holes.** Since the rivet can expand up to its own head diameter, accurate hole sizing or alignment is not necessary.

**To pull sheets together.** The extraordinary rivet tail expansion automatically effects superior clamp-up action on the parts being assembled.

**Over a vast range of thicknesses.** The "dubble-bubble" expansion feature offers the capability to fasten securely in both thick and thin grip ranges with a single length rivet.

**While providing a sealed stem.** The rivet material flows both behind and in front of the mandrel insuring a positively retained and sealed stem.

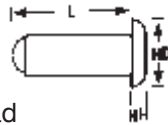

Dome Head

Aluminum Rivets  
Steel mandrels  
(Zinc & Yellow)

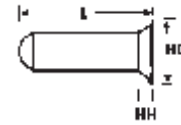

120° Countersunk

Auveco Part No.				Head (Flange) Style	Rivet Dia.	Grip	Length L	Flange Dia. HD	Flange Height HH	Hole Size
Unit Package										
50	100	500	1000							
.....	<b>10336</b>	<b>10337</b>	.....	Countersunk	1/8"	To 1/4"	15/32"	.205"	.030"	.136"
.....	<b>10348</b>	<b>10349</b>	<b>10350</b>	Dome	1/8"	To 5/16"	1/2"	.215"	.044"	.136"
.....	<b>10351</b>	<b>10352</b>	.....	Dome	5/32"	To 1/4"	15/32"	.255"	.057"	.166"
.....	<b>10339</b>	.....	.....	Countersunk	5/32"	To 5/16"	17/32"	.245"	.032"	.166"
.....	<b>10354</b>	<b>10355</b>	<b>10356</b>	Dome	3/16"	To 1/4"	17/32"	.349"	.070"	.199"
.....	<b>10357</b>	<b>10358</b>	<b>10359</b>	Dome	3/16"	To 7/16"	23/32"	.349"	.070"	.199"
.....	<b>10342</b>	<b>10343</b>	.....	Countersunk	3/16"	To 5/16"	19/32"	.339"	.050"	.199"
.....	<b>10345</b>	<b>10346</b>	.....	Countersunk	3/16"	To 1/2"	25/32"	.339"	.050"	.199"
<b>17654</b>	<b>17655</b>	.....	.....	Dome	1/4"	To 11/32"	21/32"	.500"	.094"	.268"

## Avex® Brazier Head Rivets



Auveco Part No.	Rivet Dia.	Grip Range	Rivet Body Length	Head Dia.	Unit Pkg.
<b>Aluminum Rivet -Steel Mandrel (Zinc &amp; Yellow)</b>					
<b>17432</b>	3/16"	1/16"-1/4"	1/2"	15/32"	50
<b>17433</b>	3/16"	3/16"-7/16"	11/16"	15/32"	50

## Stavex® Large Flange Rivets

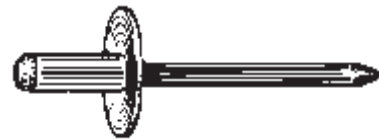

- Large flange head enables soft, pliable materials to be fastened
- All steel construction (zinc plated) provides high shear and tensile values.
- Typical applications:
  - Plastic energy absorber strip to automotive bumper
  - Plywood liners to both sidewalls and roofs in truck bodies and trailers

Auveco Part No.	Dia.	Grip	Flange Dia.	Hole Size	Unit Pkg.
<b>16988</b>	3/16"	3/16"-1/4"	5/8"	.192-.196"	25
<b>16989</b>	3/16"	1/4"-3/8"	5/8"	.192-.196"	25
<b>16990</b>	3/16"	3/8"-1/2"	5/8"	.192-.196"	25

# Sec. 14

## AUVECO KLAMP-TITE RIVET

Largest Blind Head  
Mandrel Breaks Flush With  
Top Of Rivet Head Anywhere  
Within Grip Range.  
Fills Hole Tightly, High Clamp-Up,  
Water Tight Capability, Fully Cored



Structural - Self Plugging  
Head Style - Protruding

Material:  
Rivet Sleeve -  
5056 Aluminum  
Mandrel -7075 Aluminum  
Finish: Wax (Do Not Remove)

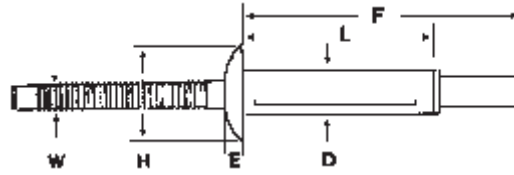

**Note: For use with  
(13808-3/16") and  
(13809-1/4") nose pieces  
with pneumatic tool.**

Auveco Part No.	Unit Pkg.	Rivet Dia.	Grip Range	Hole And Drill Size	W Mand. Dia.	D Rivet Dia.	H Head Dia.	E Head Thick	L Rivet Length Max.	F O.A. Length Max.
<b>13766</b>	50	3/16	3/64"-1/4"	.204-.209 (#5)	.103	.200	.445	.088	.890	1.211
<b>13767</b>			3/16"-3/8"						.985	1.303
<b>13768</b>			3/8"-9/16"						1.045	1.286
<b>13769</b>	25	1/4	3/64"-1/4"	.252-.262 (F)	.136	.245	.560	.113	.920	1.292
<b>13770</b>			3/16"-3/8"						1.045	1.417

### Large Head 3/16" Plywood Rivets



Non-Structural -Break Mandrel Rivets  
Aluminum Rivet, Steel Mandrel (Plated)

Auveco Part No.	Grip	Hd. Dia.	Head Thick.	Hole Size & Drill	Unit Pkg.
<b>13805</b>	3/8"-1/2"	5/8"	3/32"	.192 To .196"	50
<b>13806</b>	5/8"-3/4"	5/8"	3/32"		50
<b>13807</b>	7/8"-1"	5/8"	3/32"	#11	50

# BLIND TACKING RIVETS

**Sec. 14**

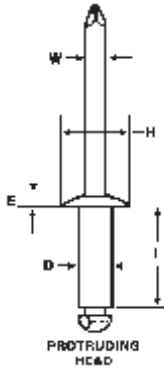

Nom. Rivet Dia.	Hole Size And Drill Number	W Mand. Dia.	D Rivet Dia.	Protruding Head		Large Flange Head	
				H Head Dia.	E Max. Head Thick	H Head Dia.	E Max
1/4"	.257-.261 (F)	.151	.250	.500	.080	.750	.107

\*L -Length varies with each grip length

Steel Rivet -Plated  
Steel Mandrel -Coated

Non-structural -Break mandrel rivets  
Conform to IFI-114 Standards

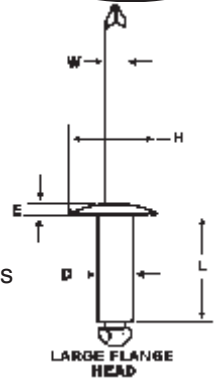

Auveco Part No.			Head Style	Rivet Dia.	Grip	Rivet Length L
Unit Package						
25	50	100				
<b>13779</b>	—	<b>13780</b>	Protruding	1/4"	1/8"-1/4"	1/2"
—	<b>13793</b>	—	Large Flange	1/4"	1/8"-1/4"	1/2"
<b>13781</b>	—	<b>13782</b>	Protruding	1/4"	1/4"-3/8"	5/8"
—	<b>13794</b>	—	Large Flange	1/4"	1/4"-3/8"	5/8"
<b>13783</b>	—	<b>13784</b>	Protruding	1/4"	3/8"-1/2"	3/4"
—	<b>13795</b>	—	Large Flange	1/4"	3/8"-1/2"	3/4"
<b>13796</b>	—	—	Large Flange	1/4"	1/2"-5/8"	13/16"
<b>13787</b>	—	<b>13788</b>	Protruding	1/4"	5/8"-3/4"	1"
<b>13797</b>	—	—	Large Flange	1/4"	5/8"-3/4"	1"
<b>13798</b>	—	—	Large Flange	1/4"	3/4"-7/8"	1-1/8"
<b>13799</b>	—	—	Large Flange	1/4"	7/8"-1"	1-1/4"

## Patching Rivets

- Sealing Capability • Vibration Resistant • Hole Filling
- 325 PSI Shear Strength • 500 PSI Tensile Strength
- Non-Structural -Break mandrel rivets

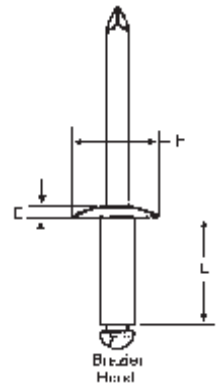

Auveco Part No.	Rivet Dia.	Grip	Length L	Head Dia.	Head Thick. E	Hole & Drill Size	Unit Pkg.
<b>13801</b>	3/16"	1/16"-1/4"	.490"	15/32"	.099"	.199" to .216"	50

Aluminum Rivet, Steel Mandrel



Type 1

## Large Secondary Head Rivets



Type 2

Rivets that fasten securely into thick and thin materials.  
Will pull soft or brittle materials. Can be used in an oversized hole.

Auveco Part No.	Illustration Type	Head (Flange) Type & Diameter	Rivet Dia.	Grip Range	Rivet Length Excluding Flange	Unit Pkg.
<b>Aluminum Rivet, Aluminum Mandrel</b>						
<b>17471</b>	1*	Dome	5/16"	1/8"	5/64"-3/8"	25
<b>19062</b>	1	Dome	5/16"	5/32"	0-1/4"	25
<b>16895</b>	2	Dome	15/32"	3/16"	5/64"-3/8"	25

\* Not A Split Type

# Sec. 14

# MONOBOLT® FASTENING SYSTEM

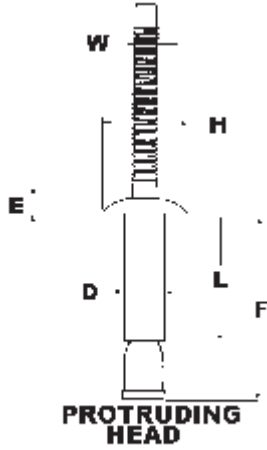

Nom. Rivet Dia.	Hole Size And Drill Number	W Mand. Dia.	D Rivet Dia.	Protruding Head	
				H Head Dia.	E Head Thick
3/16	.191-.201 (#11)	.118	.187	.390	.070
1/4	.261-.272(G)	.157	.257	.515	.100

Typical Rivet Shear And Tensile Strength (lbs) and Mandrel Push-Out When Installed In Nominal Grip.

Rivet Dia.	Aluminum Rivet Aluminum Mandrel			Steel Rivet Steel Mandrel		
	Shear	Tensile	Mandrel Push-Out	Shear	Tensile	Mandrel Push-Out
3/16	625	500	50	1300	1000	100
1/4	1300	890	100	2400	2150	250



Auveco Part No.	Dia	Grip	DIM "L"	DIM "F"	Head Style	Material	Unit Pkg.
12080	3/16"	.062/.270	.406	.748	Protruding	Steel-Zinc Plated	25
12088	3/16"	.062/.270	.406	.748	Protruding	Steel-Zinc Plated	100
12081	3/16"	.214/.420	.531	.882	Protruding	Steel-Zinc Plated	25
12089	3/16"	.214/.420	.531	.882	Protruding	Steel-Zinc Plated	100
12083	3/16"	.214/.420	.531	.846	Protruding	Aluminum	25
12091	3/16"	.214/.420	.531	.846	Protruding	Aluminum	100
12084	1/4"	.080/.375	.550	.971	Protruding	Steel-Zinc Plated	25
12092	1/4"	.080/.375	.550	.971	Protruding	Steel-Zinc Plated	100
12085	1/4"	.350/.625	.855	1.123	Protruding	Steel-Zinc Plated	25
12093	1/4"	.350/.625	.855	1.123	Protruding	Steel-Zinc Plated	100
12086	1/4"	.080/.375	.550	.961	Protruding	Aluminum	25
12094	1/4"	.080/.375	.550	.961	Protruding	Aluminum	100
13773	1/4"	.350/.625	.810	1.174	Protruding	Aluminum	25
13774	1/4"	.350/.625	.810	1.174	Protruding	Aluminum	100

Nose pieces for 12087 Gun  
Refer to page 238 for illustrations

## Monobolt Nosepiece

19622 For 3/16" Monobolt  
13825 For 1/4" Monobolt

UNIT PACKAGE: 1

### The System

**Blind Installation** -The single side installation feature of the Auveco Monobolt System allows one operator to produce high quality structural joints in seconds. Use of the Monobolt power tool does not require special skill or training, because the tool completely controls the installation cycle.

**Multi-Grip** One size Monobolt fastener will function effectively in a wide range of material thicknesses (Example: .080" to .375"). This versatility decreases the potential for production errors and reduces fastener inventory requirements.

**Uniform Clamping Action** Monobolt fasteners are engineered to draw materials together by developing positive clamping action.



### And Its Advantages

**Structural Fastening** An installed Monobolt fastener yields high shear and tensile values. Conventional fasteners can be replaced by Monobolt without compromising structural requirements.

**Positive Stem Retention:** At the completion of the installation cycle, the stem is mechanically locked into the Monobolt shell, creating a vibration-proof joint of assured structural quality.

**Flush Break Stem:** Within the specific grip range for each size, Monobolt fastener, the stem is designed to break flush with the low profile head. Secondary finishing operations, such as grinding or milling, are not necessary to achieve good product appearance.

**Complete Hole Fill:** During installation, the Monobolt shell expands into 360° contact with the walls of the parent material. This feature, in conjunction with positive stem retention, produces weather resistant joints.

**Quiet, Safe Installation:** The Monobolt System, operating at 85db ("A" Weighted), complies with OSHA regulation governing plant noise levels and operator safety

### How It Works



1. The Monobolt fastener is loaded into the nose of the placing tool and inserted in a prepared hole. As the tool is actuated, the pulling jaws grip the Monobolt stem.



2. An axial pull draws the stem through the shell, expanding it radially. During this phase, the hole is completely filled and work pieces are drawn together.



3. When the stem reaches a pre-determined position within the Monobolt shell, it separates flush with the head profile regardless of work piece thickness. Simultaneously, the stem section remaining in the shell is mechanically locked in place by the Monobolt tool.

## 12087

Gun for setting Monobolts and conventional Avex and Stavex rivets.  
Comes complete with nose pieces for 1/8", 3/16"  
and 1/4" Avex rivets and 3/16" Stavex rivets.  
Requires Nose Pieces 19622 and 13825 to set Monobolts.  
Will not set "Peel-Type" rivets.

UNIT PACKAGE: 1



# ULTRA GRIP DOME HEAD HIGH STRENGTH RIVETS



High strength Ultra grip rivets feature a positive mechanical locking system that provides superior holding power. This system also guarantees 100% mandrel retention that's visually verifiable. Can be set with Auveco rivet gun 11817.

Auveco Part No.	Rivet Dia.	Grip Range	Rivet Body Length	Head Dia.	Unit Pkg.	Conversion			
						Pop® Ultra Grip	Cherry Monobolt	Avdel Monobolt	Huck Magna-Lock
<b>Aluminum Rivet -Aluminum Mandrel</b>									
17421	3/16"	1/16" -17/64"	13/32"	3/8"	25	AD627OUG	BAPV-64	2774-0613	MGLP-B6-4
17422	3/16"	1/16" -7/16"	9/16"	3/8"	25	AD6437UGX	—	2774-0617	MGLP-B6-E
17423	1/4"	5/64" -3/8"	9/16"	1/2"	25	AD8375UG	BAPV-86	2774-0817	MGLP-B8-6
17424	1/4"	5/64" -5/8"	13/16"	1/2"	15	AD8625UGX	—	2774-0824	MGLP-B8-E
<b>Steel Rivet -Steel Mandrel</b>									
17425	3/16"	1/16" -17/64"	13/32"	3/8"	25	SD627OUG	SSPV-64	2771-0613	MGLP-R6-4
17426	3/16"	1/16" -7/16"	9/16"	3/8"	25	SD6437UGX	—	2771-0617	MGLP-R6-4
17427	1/4"	5/64" -3/8"	9/16"	1/2"	25	SD8375UG	SSPV-86	2771-0817	MGLP-R8-6
17428	1/4"	5/64" -5/8"	13/16"	1/2"	15	SD8625UGX	—	2771-0824	MGLP-R8-E
<b>Stainless Steel Rivet -Stainless Steel Mandrel</b>									
17429	3/16"	1/16" -17/64"	13/32"	3/8"	10	SSD627OUG	CCPV64	2711-0613	MGLP-U6-4
17430	1/4"	5/64" -3/8"	9/16"	1/2"	10	SSD8375UG	CCPV-86	2711-0817	MGLP-U8-6



## Closed -End Rivets

Can Be Set With Auveco Rivet Gun 7915.

Auveco Part No.	Head (Flange) Type & Diameter	Rivet Dia.	Grip Range	Rivet Length Excluding Flange	Unit Pkg.
<b>Black Aluminum Rivet -Black Aluminum Mandrel</b>					
17408	Dome	15/64"	1/8"	13/64" - 9/32"	50
17409	Dome	3/8"	3/16"	1/8" - 3/16"	25
17410	Dome	3/8"	3/16"	3/8" -1/2"	25
<b>Aluminum Rivet -Aluminum Mandrel</b>					
17417	Dome	15/64"	1/8"	1/16" - 1/8"	50
17419	Dome	3/8"	3/16"	1/16" - 1/8"	50
17420	Dome	3/8"	3/16"	1/8" - 1/4"	50
<b>Aluminum Rivet -Steel Mandrel</b>					
17411	Dome	15/64"	1/8"	1/16" - 1/8"	50
17412	Dome	15/64"	1/8"	3/16" - 1/4"	50
17413	Dome	15/64"	1/8"	5/16" - 3/8"	50
19065	Countersunk	5/16"	5/32"	1/8" - 3/16"	100
17414	Dome	3/8"	3/16"	1/16" - 1/8"	50
17415	Dome	3/8"	3/16"	1/8" - 1/4"	50
17416	Dome	3/8"	3/16"	1/4" - 3/8"	50

## Sec. 14

# "PEEL-TYPE" SPECIALTY RIVETS

Rivets Are Listed In Columns By Diameter Then By Flange Diameter & Lastly By Minimum Grip



### 19462

(W525170-S)

"Peel-Type Rivet  
3/16" Diameter  
Grip: 1/32"-1/4"  
Flange Diameter: 1/2"  
Aluminum Rivet  
Steel Mandrel (Zinc)  
Heat Shield &  
Outer Moulding  
Ford Continental,  
Crown Victoria,  
Explorer, Grand Marquis,  
Mark VII, Ranger, Sable  
Taurus & Town Car  
1995-On

UNIT PACKAGE: 25



### 19110

(W525172-S)

"Peel-Type" Rivet  
1/4" Diameter  
Grip: 1/32"-7/32"  
Flange Diameter: 1/2"  
Aluminum Rivet  
Steel Mandrel (Zinc)  
Glass, Regulator Assembly  
& Remote Latch Assembly  
Ford Mustang &  
Lincoln Continental  
1994-On

UNIT PACKAGE: 25



### 11852

(Ford: 388047-S100;  
GM: 14078435)

"Peel-Type" Rivet  
1/4" Diameter  
Grip: 5/64" - 7/64"  
Flange Diameter 1/2"  
Recess Under Head  
Aluminum Rivet  
Steel Mandrel  
Attaches Outside  
Door Handle  
Ford 1978-On  
Heat Shield Attachment  
GM

UNIT PACKAGE: 25



### 19414

(W525170-S417)

"Peel-Type" Rivet  
3/16" Diameter  
Grip: 1/32"-1/4"  
Flange Diameter: 1/2"  
Aluminum Rivet (Black)  
Steel Mandrel (Zinc)  
Side Door  
Lock Attachment  
Mercury Villager  
1995-On

UNIT PACKAGE: 25



### 19461

(W525172-S417)

"Peel-Type" Rivet  
1/4" Diameter  
Grip: 1/32"-7/32"  
Flange Diameter: 1/2"  
Aluminum Rivet (Black)  
Steel Mandrel (Zinc)  
Outside Door Handle  
Ford Crown Victoria,  
Econoline, Explorer,  
Grand Marquis, Ranger,  
Sable, Taurus & Windstar  
1995-On

UNIT PACKAGE: 15



### 12653

(388047-S102)

"Peel-Type" Rivet  
Dia: 1/4"  
Grip: 3/32"-1/8"  
Flange Dia: 1/2"  
Aluminum Rivet (Black)  
Steel Mandrel  
Door Handle Assembly  
Ford 1981-On

UNIT PACKAGE: 25



### 11620

(GM: 9436175;  
Ford: 385189-S100;  
Chrys: 6031115)

"Peel-Type" Rivet  
1/4" Diameter  
Grip: 1/32" - 9/64"  
Flange Diameter: 1/2"  
Aluminum Rivet  
Steel Mandrel  
Window Regulators  
GM, Ford & Chrysler  
1971-On  
Use with Auveco Tool  
11817 & Nose Piece  
11853

UNIT PACKAGE: 25

### 16837

Same as 11620 Except For  
Packing

UNIT PACKAGE: 50

**The Auveco FC-1  
Flip Chart  
Is A Great Selling Tool.  
Use It To Help Boost Your  
Sales. Refer To The Color  
Pages At The Front Of The  
Book.**



### 15684

(20713843)

"Peel-Type" Rivet  
1/4" Diameter  
Grip 7/64" - 11/64"  
Flange Diameter 1/2"  
Recess Under Head  
Aluminum Rivet,  
Steel Mandrel  
Used On Window  
Regulators  
& Door Lock Assemblies  
GM A & J Cars

UNIT PACKAGE: 25



# "PEEL-TYPE" SPECIALTY RIVETS

Sec. 14

Rivets Are Listed In Columns By Diameter Then By Flange Diameter & Lastly By Minimum Grip



## 12655

(GM: 9437486;  
Chry: 6032926)

"Peel-Type" Rivet  
1/4" Diameter  
Grip: 9/64" - 3/16"  
Flange Diameter: 1/2"  
Aluminum Rivet  
Steel Mandrel  
Window Regulators  
GM 1981-On

UNIT PACKAGE: 25



## 11621

(Ford: 385323-S100;  
Chrys: 6031091;  
GM: 9437938)

"Peel-Type" Rivet  
1/4" Diameter  
Grip: 33/64" - 19/32"  
Flange Diameter: 1/2"  
Aluminum Rivet  
Steel Mandrel  
Window Regulator  
GM, Ford & Chrysler  
1976-On

Use with Auveco  
Tool 11817 &  
Nose Piece 11853

UNIT PACKAGE: 10

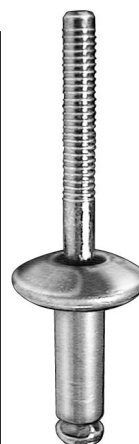

## 19420

(W525174S)

"Peel-Type" Rivet  
1/4" Diameter  
Grip: 13/64" - 13/32"  
Flange Diameter: 5/8"  
Aluminum Rivet  
Steel Mandrel (Zinc)  
Door Handle  
Ford Ranger  
1997-On

UNIT PACKAGE: 25



## 14486

(GM: 9437486;  
Chry: 6032926)

"Peel-Type" Rivet  
1/4" Diameter  
Grip: 9/64" - 3/16"  
Flange Diameter: 1/2"  
Aluminum Rivet  
Steel Mandrel  
Used On Window  
Regulators,  
Quarter Vent Handle  
Assemblies & Electrical Door  
Lock Linkage.  
GM & Chrysler 1981-On

UNIT PACKAGE: 25



## 12658

(GM: 12338153,  
20184399;  
Ford: 389268-S100)

"Peel-Type" Rivet  
1/4" Diameter  
Grip 11/16" - 3/4"  
Flange Diameter 1/2"  
Aluminum Rivet  
Steel Mandrel  
Window Regulator  
GM & Ford 1979-On

UNIT PACKAGE: 25



## 19456

(W525175-S)

"Peel-Type" Rivet  
1/4" Diameter  
Grip: 25/64" - 21/32"  
Flange Diameter: 5/8"  
Aluminum Rivet  
Steel Mandrel (Zinc)  
Front Door Window  
Ford Continental,  
Crown Victoria,  
Explorer, Grand Marquis,  
Mark VIII, Mustang,  
Ranger, Sable,  
Taurus, Town Car  
& Windstar  
1996-On

UNIT PACKAGE: 15



## 20402

(9437643)

"Peel-Type" Rivet  
1/4" Diameter  
Grip: 3/16" - 1/4"  
Flange Diameter: 1/2"  
Aluminum Rivet  
Steel Mandrel (Zinc)  
Window Regulator  
Saturn  
1993 - On

UNIT PACKAGE: 25



## 18396

(N808594-S100)

"Peel-Type" Rivet  
1/4" Diameter  
Grip: 1/8" - 5/16"  
Flange Diameter: 5/8"  
Aluminum Rivet  
Steel Mandrel  
(Zinc & Yellow)  
Door Lock Actuator  
Ford

UNIT PACKAGE: 25



## 18167

(Ford: N804193-S100;  
GM: 9441592, 15672713)

"Peel-Type" Rivet  
1/4" Diameter  
Grip: 3/32" - 9/64"  
Flange Diameter: 3/4"  
Aluminum Rivet (Black)  
Steel Mandrel  
Front Door Handle  
& Door Lock Actuator  
Tempo, Topaz, T-Bird  
& Cougar 1984-On  
Rocker Panel Moulding  
Chevrolet Beretta & Corsica  
1996 - 92

UNIT PACKAGE: 25

# Sec. 14

# SPECIALTY RIVETS

Rivets Are Listed In Columns By Diameter Then By Flange Diameter & Lastly By Minimum Grip



**19458**  
(N808689-S417)  
"Peel-Type" Rivet  
1/4" Diameter  
Grip: 1/8"-21/64"  
Flange Diameter: 3/4"  
Aluminum Rivet (Black)  
Aluminum Mandrel  
Door Lock Actuator  
Ford Continental,  
Crown Victoria,  
F Series Truck,  
Grand Marquis,  
Marx VII, Mustang,  
Ranger, Sable, Taurus,  
Town Car & Windstar  
1995-On  
UNIT PACKAGE: 10



**11104** U.P.: 100  
**11105** U.P.: 500  
**11106** U.P.: 1000  
(Ford: 383229-S)  
Dia: 1/8"  
Grip: 3/16"-1/4"  
Flange Dia: 3/16"  
Stainless Steel Rivet  
Steel Mandrel  
REPLACES WELDED STUDS  
ON BODY PANELS.  
USE AUVECO RIVET GUN 7915  
& NOSE PIECE 7981.



**17469**  
(375936-S)  
Diameter: 1/8"  
Grip: 1/32"-1/8"  
Flange Dia: 1/4"  
Stainless Steel Rivet  
Stainless Steel Mandrel  
Attaches Body Side Mouldings  
(Sets flush, does not leave a raised stud)  
UNIT PACKAGE: 100



**10658**  
Dia: 3/32"  
Grip: 1/8"-1/4"  
Flange Dia: 3/16"  
Aluminum Rivet  
Aluminum Mandrel  
REPLACES WELDED STUDS ON  
BODY PANELS.  
UNIT PACKAGE: 100



**7981**  
Rivet Gun Nose Piece  
Used to set Auveco  
Rivet 11104  
With Rivet Gun 7915  
UNIT PACKAGE: 1



**18303**  
1/8" Diameter  
Grip: 1/16"-1/8"  
Flange Diameter: 1/4"  
Aluminum Rivet (Black)  
Aluminum Mandrel  
Attachment Of Rear  
Window Trim  
Moulding  
Ford Explorer  
1990-On  
UNIT PACKAGE: 50



**18499**  
1/8" Diameter  
Grip: 1/8"-3/16"  
Flange Dia: 3/16"  
Aluminum Rivet  
Aluminum Mandrel  
Trim Moulding Attachment  
UNIT PACKAGE: 100



**17470**  
(378527)  
Diameter: 1/8"  
Grip: 1/8"-3/16"  
Flange Dia: 1/4"  
Aluminum Rivet  
Aluminum Mandrel  
Attaches Climate Controls  
Ford  
UNIT PACKAGE: 50



**17408**  
(N803933-S101)  
1/8" Diameter  
Grip: 13/64"-9/32"  
Flange Diameter: 15/64"  
Closed End  
Aluminum Rivet (Black)  
Aluminum Mandrel (Black)  
Luggage Rack  
Ford  
UNIT PACKAGE: 50



**18500**  
1/8" Diameter  
Grip: 3/16"-1/4"  
Flange Dia: 3/16"  
Aluminum Rivet  
Aluminum Mandrel  
Trim Moulding Attachment  
UNIT PACKAGE: 100



**17467**  
(375203S)  
Diameter: 1/8"  
Grip: 1/8"-3/16"  
Flange Dia: 1/4"  
Stainless Steel Rivet; Steel Mandrel  
Attaches Body Side Moulding Ret.  
(Sets flush, does not  
leave a raised stud)  
Ford  
UNIT PACKAGE: 100

# SPECIALTY RIVETS

## Sec. 14

Rivets Are Listed In Columns By Diameter Then By Flange Diameter & Lastly By Minimum Grip



### 19202

1/8" Diameter  
Grip: 3/16"-1/4"  
Flange Diameter: 1/4"  
Aluminum Rivet (Black)  
Aluminum Mandrel  
GM & General Purpose

UNIT PACKAGE: 100



### 12656

(20325696)

Dia: 1/8"  
Grip: 1/8" - 3/16"  
Flange Dia: 5/16"  
Aluminum Rivet  
Steel Mandrel  
Rear Window Gasket Attachment  
GM 1981-On

UNIT PACKAGE: 50



### 16834

(N805759-S100)

Diameter: 1/8"  
Grip: 1/8"-3/16"  
Flange Diameter: 3/8"  
Aluminum Rivet (Black)  
Aluminum Mandrel  
Windshield Side Rail  
Ford T-Bird &  
Mercury Cougar  
1989-On

UNIT PACKAGE: 50



### 19657

(6034848)

1/8" Diameter  
Grip: 1/32"-3/16"  
Flange Diameter: 5/16"  
Aluminum Rivet  
Steel Mandrel  
(Zinc & Yellow)  
Rocker Panel & Cladding  
Chrysler LH Series  
1993-On

UNIT PACKAGE: 50



### 20628

(90269-04050)

1/8" (3.2mm) Diameter  
Grip: 5/32" - 5/16"  
(4mm - 8mm)  
Flange Diameter:  
5/16" (8mm)  
Aluminum Rivet  
Steel Mandrel  
With Plastic Cap  
Windshield, Side &  
Trunk Moulding  
Lexus GS300, 400, 430  
& SC430  
1998 - On

UNIT PACKAGE: 15



### 16686

(9432552)

Dia: 1/8"  
Grip: 1/8" - 3/16"  
Flange Dia: 3/8"  
Aluminum Rivet  
Steel Mandrel  
Large Flange  
Multi-Purpose Rivet  
GM  
1978-On

UNIT PACKAGE: 100



### 20627

(90269-04053)

1/8" (3.2mm) Diameter  
Grip: 3/64" - 3/16"  
(1mm - 4.8mm)  
Flange Diameter:  
5/16" (8mm)  
Aluminum Rivet (Black)  
Steel Mandrel (Black)  
With Plastic Cap  
Mouldings  
Toyota Landcruiser  
1998 - On

UNIT PACKAGE: 10



### 17615

(6032856)

Diameter: 1/8"  
Grip: 3/16"-3/8"  
Flange Diameter: 5/16"  
Aluminum Rivet (Black)  
Steel Mandrel  
Body Side Moulding  
& Universal Applications  
Chrysler

UNIT PACKAGE: 50



### 19419

(N811460-S100)

1/8" Diameter  
Grip: 1/8"-3/16"  
Flange Diameter: 3/8"  
Steel Rivet (Black)  
Steel Mandrel  
(Zinc & Yellow)  
Door Moulding  
Ford Taurus  
1996-On

UNIT PACKAGE: 15

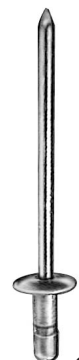

### 19406

(6035414)

Diameter: 1/8"  
Grip: 1/16"-1/4"  
Flange Diameter: 5/16"  
Aluminum Rivet  
Steel Mandrel  
(Zinc & Yellow)  
Cladding To  
Fender Attachment  
Chrysler Concorde, Eagle  
& Intrepid  
1997-On

UNIT PACKAGE: 50



### 18304

1/8" Diameter  
Grip: 1/16"-1/8"  
Flange Diameter: 3/8"  
Aluminum Rivet (Black)  
Steel Mandrel  
Attachment Of Door  
Glass Moulding  
Ford 1993-On

UNIT PACKAGE: 50



### 18461

(N807620-S100)

Split-Type Rivet  
5/32" Diameter  
Grip: 3/64"-1/4"  
Flange Diameter: 5/16"  
Aluminum Rivet (Black)  
Aluminum Mandrel  
Wheel Openings  
Lincoln 1994-On

UNIT PACKAGE: 25

**Sec. 14****SPECIALTY RIVETS**

Rivets Are Listed In Columns By Diameter Then By Flange Diameter &amp; Lastly By Minimum Grip

**20383**

(90084-26002)

5/32" (4mm) Diameter  
 Grip: 1/16" - 1/4"  
 (1.6mm - 6.3mm)  
 Flange Diameter: 5/16" (8mm)  
 Aluminum Rivet  
 Aluminum Mandrel  
 Door Window Moulding  
 Toyota Camry  
 1997 - On

UNIT PACKAGE: 50

**20629**

(6036148-AA)

Split-Type Rivet  
 5/32" Diameter  
 Grip: 3/64" - 1/4"  
 Flange Diameter: 7/16"  
 Aluminum Rivet (Black)  
 Aluminum Mandrel  
 Front Bumper, Trim Panel,  
 Instrument Panel &  
 Running Boards  
 Chrysler  
 1999 - On

UNIT PACKAGE: 25

**17006**

(N900-845-01)

Diameter: 5/32"  
 Grip: 1/4" - 3/8"  
 Flange Dia. 15/32"  
 Aluminum Rivet (Black)  
 Steel Mandrel  
 Wheel Opening  
 Moulding Attachment  
 Jetta, Rabbit & Golf

UNIT PACKAGE: 25

**16687**(GM: 9432137;  
Chrys: 6032138)

Diameter: 5/32"  
 Grip: 1/8"-3/16"  
 Flange Diameter: 5/16"  
 Aluminum Rivet,  
 Steel Mandrel  
 Countersunk Head  
 Trunk Lock  
 Swivel Emblem Rivet  
 Requires nosepiece 16688  
 GM 1973-On

UNIT PACKAGE: 25

**20398**

(W700636-S303)

11/64" (4.4mm) Diameter  
 Grip: Up to 15/64" (6mm)  
 Flange Diameter:  
 3/8" (9.5mm)  
 Aluminum Rivet  
 (Black) With Plastic Cap  
 Stainless Steel Mandrel  
 Luggage Rack,  
 Trunk & Bumpers  
 Ford  
 2000 - On

UNIT PACKAGE: 15

**15187**(N804583S)  
Black Nylon

Cowl Vent Grille  
 Retainer Rivet  
 5/32" (4mm) Diameter  
 Grip: 15/64" - 13/32"  
 (6mm-10.5mm)  
 Flange Size: 11/32" x 5/8"  
 (8.5mm x 15.5mm)  
 Ford Aerostar 1986-On

UNIT PACKAGE: 25

**16688**

Rivet Gun Nosepiece  
 Used to set Auveco Rivet 16687

UNIT PACKAGE: 1

**17468**

(16715497)

Dia: 5/32"  
 Grip: 3/64"-1/4"  
 Flange Dia: 15/32"  
 Aluminum Rivet  
 Steel Mandrel  
 Attaches Support  
 Rails To Load  
 Floor  
 GM

UNIT PACKAGE: 50

**17177**

(22093245)

Dia: 5/32"  
 Grip: 1" - 1-15/64"  
 Flange Dia: 5/16"  
 Aluminum Rivet  
 Aluminum Mandrel  
 Door Lock Actuator  
 GM 1990-On

UNIT PACKAGE: 25

**19376**

(979878-6)

5/32" (4mm) Diameter  
 Grip: 1/8"-11/32"  
 (3mm-8.5mm)  
 Flange Diameter: 15/32"  
 (12mm)  
 Aluminum Rivet  
 (Black Polyethylene  
 Coating)  
 Aluminum Mandrel  
 Bumper & Wheel Housing  
 Volvo  
 1993-On

UNIT PACKAGE: 15

**18169**

(15956062)

3/16" Diameter  
 Grip: 1/8"-1/4"  
 Flange Diameter: 11/32"  
 Aluminum Rivet &  
 Steel Mandrel  
 Door Assembly  
 GM Trucks  
 C, K Models  
 1994-On

UNIT PACKAGE: 25

# SPECIALTY RIVETS

Sec. 14

Rivets Are Listed In Columns By Diameter Then By Flange Diameter & Lastly By Minimum Grip



## 19514

(10125439, 10201332)

Split-Type Rivet  
3/16" Diameter  
Grip: 3/64"-15/64"  
Flange Diameter: 3/8"  
Aluminum Rivet (Black)  
Aluminum Mandrel  
Door Actuator, Door,  
Body & Fender  
Moulding and Dash  
Panel Insulation  
Buick Regal,  
Chev. Lumina APV,  
K & T Trucks,  
Olds Silhouette and  
Pontiac Trans Sport  
1990-On

UNIT PACKAGE: 25



## 16864

(10125439)

Split-Type Rivet  
Dia: 3/16"  
Grip: 3/64"-11/32"  
Flange Dia: 3/8"  
Aluminum Rivet (Black)  
Aluminum Mandrel  
Moulding Attachment  
APV Vans 1990-On

UNIT PACKAGE: 25



## 18912

(22585836,  
22641917)

3/16" Diameter  
Grip: 1/16" - 17/64"  
Flange Diameter: 3/8"  
Steel Rivet (Black)  
Steel Mandrel (Zinc)  
Rear Side Door  
Outside Handle Attachment  
Cadillac DeVille & Seville,  
Chevrolet Cavalier And  
Pontiac Sunfire 1994-On

UNIT PACKAGE: 25



## 19459

(384432-S)

3/16" Diameter  
Grip: 1/16"-1/8"  
Flange Diameter: 3/8"  
Aluminum Rivet  
Steel Mandrel  
Outer Moulding  
Ford F Series & Villager  
And Nissan Quest  
1995-On

UNIT PACKAGE: 25



## 18329

(3828472)

3/16" Diameter  
Grip: 1/4"-3/8"  
Flange Dia.: 3/8"  
Aluminum Rivet (Black)  
Aluminum Mandrel  
Attachment Of Front  
Fender Lower Rocker  
Moulding  
Chevrolet Astro & GMC Safari  
Mini-Vans  
1995-On

UNIT PACKAGE: 50



## 19808

(20743322)

3/16" Diameter  
Grip: 1/4"-13/32"  
Flange Diameter: 3/8"  
Aluminum Rivet  
Steel Mandrel  
Mount Door  
Glass To Frame  
GM

1985-On

UNIT PACKAGE: 50



## 17410

(390428-S100)

3/16" Diameter  
Grip: 3/8"-1/2"  
Flange Diameter: 3/8"  
Closed End  
Aluminum Rivet (Black)  
Aluminum Mandrel  
(Black)  
Luggage Rack  
Ford

UNIT PACKAGE: 25



## 19751

(6035122)

3/16" Diameter  
Grip: 3/8"-1/2"  
Flange Diameter: 3/8"  
Steel Rivet (Zinc & Black)  
Steel Mandrel (Zinc)  
Rear Bumper,  
Carpets & Mats  
Jeep Cherokee,  
XJ & Grand ZJ  
1994-On

UNIT PACKAGE: 25



## 18328

(22580569)

3/16" Diameter  
Grip: 25/64"-27/64"  
Flange Diameter: 3/8"  
Aluminum Rivet  
Steel Mandrel  
(Zinc & Yellow)  
Attachment Of Front  
Door Window Stabilizer  
Chevrolet Beretta  
& Corsica 1994-On

UNIT PACKAGE: 25



## 19515

(15704030)

3/16" Diameter  
Grip: 3/16"-3/8"  
Flange Diameter: 25/64"  
Aluminum Rivet (Black)  
Steel Mandrel (Zinc & Yellow)  
Body Moulding,  
Bumper Fascia,  
Hood Prop Rod and  
Window Hinge  
Chev. Beretta, Camaro,  
Corsica & Trucks,  
Olds Silhouette,  
Pontiac Firebird, Grand Am and  
Trans Sport  
1992-On

UNIT PACKAGE: 25

# Sec. 14

# SPECIALTY RIVETS

Rivets Are Listed In Columns By Diameter Then By Flange Diameter & Lastly By Minimum Grip



### 17121

(GM: 25618730;  
Ford: N805592-S100)

Split-Type Rivet  
Dia: 3/16"  
Grip: 5/64"-15/64"  
Flange Dia: 7/16"  
Aluminum Rivet (Black)  
Aluminum Mandrel  
Wheel House Moulding  
& General Purpose

UNIT PACKAGE: 25



### 18946

(25551202)

3/16" Diameter  
1/4" Shoulder Diameter  
Grip: 1/32"-1/8"  
Flange Diameter: 1/2"  
Steel Rivet (Zinc)  
Steel Mandrel (Zinc)  
Front & Rear Bumper Fascia  
Buick LeSabre 1992-On

UNIT PACKAGE: 25



### 18749

(9439559,  
21021319)

3/16" Diameter  
Grip: 1/16"-1/4"  
Flange Diameter: 9/16"  
Aluminum Rivet  
(Black)  
Steel Mandrel  
Rocker Panel Cover  
GM Saturn 1991-On

UNIT PACKAGE: 50



### 18927

(22569178,  
22579423)

3/16" Diameter  
Grip: 5/16" - 7/16"  
Flange Diameter: 7/16"  
Aluminum Rivet  
Steel Mandrel (Zinc)  
Front & Rear Door  
Window Sash Attachment  
Buick Skylark, Chevrolet Cavalier,  
Olds Achieva & Pontiac Grand Am  
1992-On

UNIT PACKAGE: 25



### 17431

(N804523-S)

Diameter: 3/16"  
Grip: 1/32"-9/64"  
Flange Dia: 9/16"  
Aluminum Rivet  
Steel Mandrel  
Attaches Heat Shield  
Ford

UNIT PACKAGE: 50



### 20626

(90269-05054)

3/16" (5mm) Diameter  
Grip: 1/8" - 5/16"  
(3mm - 8mm)  
Flange Diameter: 9/16"  
(14mm)  
Aluminum Rivet  
Steel Mandrel  
With Plastic Cap  
Windshield Side Moulding  
& Gas Filler Cap  
Toyota Camry & Sienna  
1997 - On

UNIT PACKAGE: 10



### 18244

(GM: 15614774)

Split-Type Rivet  
3/16" Diameter  
Grip: 3/16"-3/8"  
Flange Diameter: 29/64"  
Aluminum Rivet (Black)  
Aluminum Mandrel  
For Camper Style  
Mirrors On GM Trucks

UNIT PACKAGE: 10



### 17641

(9442361, 25609048)

Dia: 3/16"  
Grip: 3/64"-13/64"  
Flange Dia: 9/16"  
Aluminum Rivet (Black)  
Steel Mandrel (Zinc)  
Used In Place Of Screws  
When Attaching New Catalytic  
Converter Heat Shield  
Buick LeSabre & Roadmaster,  
Cadillac Brougham And  
Oldsmobile 98 & 88  
1986-On

UNIT PACKAGE: 25



### 14127

(388664-S100)

Dia: 3/16"  
Grip: 3/8"-1/2"  
Flange Dia: 9/16"  
Aluminum Rivet (Black)  
Aluminum Mandrel  
Fascia & Bumper  
Ford 1982-On

UNIT PACKAGE: 25



### 12651

(N801638-S43)

Dia: 3/16"  
Grip: Up To 1/4"  
Flange Dia: 5/8"  
Steel Rivet (Green)  
Steel Mandrel  
Attaches Heat Shield  
Ford 1981-On

UNIT PACKAGE: 25

# SPECIALTY RIVETS

**Sec. 14**

Rivets Are Listed In Columns By Diameter Then By Flange Diameter & Lastly By Minimum Grip

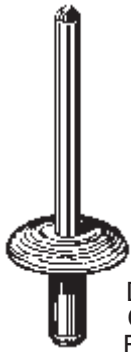

**17653**  
(9433185)

Diameter: 3/16"  
Grip: 1/8"-7/32"  
Flange Dia: 5/8"  
Steel Rivet (Zinc)  
Steel Mandrel  
Attachment of Bumper  
Impact Absorption Panel  
Buick Regal,  
Chevrolet Lumina,  
Olds Cutlass  
& Pontiac Grand Prix  
1988-On

UNIT PACKAGE: 50



**12657**  
(9439719)

Dia: 3/16"  
Grip: 1/4"-3/8"  
Flange Dia: 5/8"  
Steel Rivet (Black)  
Steel Mandrel  
Attaches Fascia To  
Underside Bumper  
GM 1981-On

UNIT PACKAGE: 50



**18935**  
(10160960)

3/16" Diameter  
Grip: 1/2" - 25/32"  
Flange Diameter: 5/8"  
Aluminum Rivet  
Steel Mandrel  
(Zinc & Yellow)  
Liftgate Strut Gate Side  
Bracket  
Lumina APV, Silhouette  
& Trans Sport 1992-On

UNIT PACKAGE: 25



**19460**  
(385974-S)

3/16" Diameter  
Grip: 3/16"-1/4"  
Flange Diameter: 5/8"  
Aluminum Rivet  
Steel Mandrel  
General Purpose  
Ford Econoline & Windstar  
1995-On

UNIT PACKAGE: 50



**16940**

(Not Supplied by OEM)

3/16" Diameter  
Grip: 1/2" - 5/8"  
Flange Diameter: 5/8"  
Aluminum Rivet & Mandrel  
Glass Stop/Roller Rivet  
Chrysler

UNIT PACKAGE: 25



**17977**

Not Supplied  
By O.E.M.

3/16" Diameter  
Grip: 5/8"-3/4"  
Flange Diameter: 5/8"  
Aluminum Rivet & Mandrel  
Glass Stop/Roller Rivet  
Chrysler

UNIT PACKAGE: 25

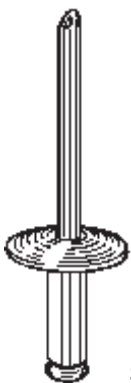

**18168**  
(9433186)

3/16" Diameter  
Grip 1/4"-3/8"  
Flange Diameter: 5/8"  
Steel Rivet (Zinc)  
Steel Mandrel  
Front & Rear Bumper  
GM Saturn 1991-On

UNIT PACKAGE: 50



**17466**  
(N905150-S)

Diameter: 3/16"  
Grip: 1/2"-5/8"  
Flange Dia: 5/8"  
Aluminum Rivet  
Steel Mandrel  
Attaches License  
Plate Bracket  
Ford

UNIT PACKAGE: 25



**19111**  
(N807168-S)

3/16" Diameter  
Grip: 11/16"-13/16"  
Flange Diameter: 3/4"  
Aluminum Rivet  
Aluminum Mandrel  
Grille & Bumper  
Ford Windstar 1995-On

UNIT PACKAGE: 25

**Sec. 14****SPECIALTY RIVETS**

Rivets Are Listed In Columns By Diameter Then By Flange Diameter & Lastly By Minimum Grip



**17637**  
(21093072)

1/4" Diameter  
Grip: 1/16" - 1/8"  
Flange Dia: 1/2"  
Steel Rivet (Olive Drab)  
Steel Mandrel (Zinc)  
Front Fender Support  
GM Saturn 1991-On

UNIT PACKAGE: 25



**16939**  
(10157547)

1/4" Diameter  
Grip: 5/64" - 3/8"  
Flange Diameter: 1/2"  
Aluminum Rivet,  
Steel Mandrel  
(Yellow Dichromate Coated)  
Front Door Window Regulator  
GM APV Vans 1990-On

UNIT PACKAGE: 10



**12654**  
(372820-S36, S40)

Dia: 1/4"  
Grip: 1/8"-1/4"  
Flange Dia: 1/2"  
Steel Rivet  
(Zinc & Gold Chrome)  
Steel Mandrel  
Front Bumper Assembly  
Ford 1979-On

UNIT PACKAGE: 25



**18889**  
(22643056)

1/4" Diameter  
Grip: 1/16" - 5/32"  
Flange Diameter: 1/2"  
Steel Rivet  
Steel Mandrel (Zinc &  
Yellow Dichromate)  
Door Window Regulator  
Buick Skylark, Chev. Cavalier,  
Olds Achieva & Aurora, And  
Pontiac Grand Am & Sunfire  
1995-On

UNIT PACKAGE: 25



**18810**  
(6033688)

1/4" Diameter  
Grip: 7/64"-3/16"  
Flange Diameter: 1/2"  
Steel Rivet  
(Zinc & Yellow)  
Steel Mandrel  
(Zinc & Yellow)  
Glass & Frame Assembly  
And Floor Pan  
Reinforcement Attachment  
Dodge Shadow, Plymouth  
Sundance  
& Jeep Cherokee  
1991-On

UNIT PACKAGE: 25



**19457**  
(N806685-S900)

1/4" Diameter  
Grip: 1/4"-3/8"  
Flange Diameter: 1/2"  
Steel Rivet (Zinc)  
Steel Mandrel (Zinc)  
Brake Shield  
Ford Windstar  
1995-On

UNIT PACKAGE: 15



**18938**  
(2024778)

1/4" Diameter  
Grip: 1/16"-1/4"  
Flange Diameter: 1/2"  
Steel Rivet (Zinc)  
Steel Mandrel (Zinc)  
Front Side Door  
Window Regulator  
Chevrolet Lumina APV,  
Olds Silhouette & Pontiac  
Trans Sport 1990-On

UNIT PACKAGE: 25



**19396**  
(N808426-S100)

1/4" Diameter  
Grip: 1/8"-1/4"  
Flange Diameter: 1/2"  
Aluminum Rivet (Black)  
Aluminum Mandrel  
Bumper Fascia  
Ford Taurus & Sable  
1996-On

UNIT PACKAGE: 25



**18171**  
(10204265)

1/4" Diameter  
Grip: 1/2"-5/8"  
Flange Diameter: 1/2"  
Aluminum Rivet  
Aluminum Mandrel  
Trunk Lock Cylinder  
Chevrolet Camaro  
1994-On

UNIT PACKAGE: 15



# SPECIALTY RIVETS

**Sec. 14**

Rivets Are Listed In Columns By Diameter Then By Flange Diameter & Lastly By Minimum Grip



**18170**  
(10204266)

1/4" Diameter  
Grip: 3/4"-1"  
Flange Diameter: 1/2"  
Aluminum Rivet  
Aluminum Mandrel  
Trunk Lock Cylinder  
Pontiac Firebird  
1994-On

UNIT PACKAGE: 10



**20170**  
(11518091)

Split-Type Rivet  
Diameter: 1/4"  
Grip: 3/16"-3/8"  
Flange Diameter: 9/16"  
Aluminum Rivet  
Aluminum Mandrel  
Front & Rear  
Bumper Fascia  
Saturn  
2000-On

UNIT PACKAGE: 15



**17639**

(Ford: N806830-S100;  
Chrys: 6035201)

Split-Type Rivet  
Diameter: 1/4"  
Grip: 3/16"-3/8"  
Flange Dia: 11/16"  
Aluminum Rivet  
(Black)  
Aluminum Mandrel  
Attachment of  
Bumper Cover  
To Bumper &  
Front License  
Plate Bracket To  
Bumper Cover  
Ford 1992-On  
Air Dam To Fascia  
Chrysler 1993-On

UNIT PACKAGE: 15



**19516**  
(N804851-S100)

Split-Type Rivet  
1/4" Diameter  
Grip: 3/64"-1/4"  
Flange Diameter: 9/16"  
Aluminum Rivet (Black)  
Aluminum Mandrel  
Front Bumper  
Ford Taurus  
1996-On

UNIT PACKAGE: 15



**19395**  
(15022087)

Diameter: 1/4"  
Grip: 3/64"-5/64"  
Flange Diameter: 19/32"  
Shoulder Diameter: 13/32"  
Steel Rivet (Zinc)  
Steel Mandrel (Zinc)  
Headlight Retainer  
GM Jimmy, Blazer &  
Bravada  
1998-On

UNIT PACKAGE: 25

**19263**

Same As 17639  
Except For Packing

UNIT PACKAGE: 25



**18929**  
(10120608)

TLR Rivet  
1/4" Diameter  
Grip: 1/8"-13/32"  
Flange Diameter: 9/16"  
Aluminum Rivet,  
Aluminum Mandrel  
Side Door Lock  
Actuator Rod Rivet  
Chevrolet Lumina APV,  
Olds Silhouette &  
Pontiac Trans Sport  
1994-90

UNIT PACKAGE: 15

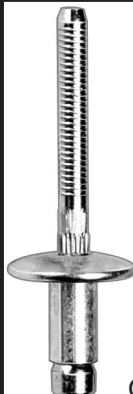

**18945**  
(3548690)

1/4" Diameter  
Grip: 1/16"-5/64"  
Flange Diameter: 11/16"  
Steel Rivet (Zinc)  
Steel Mandrel (Zinc & Yellow)  
Window Moulding  
GM 1993-On

UNIT PACKAGE: 15



**18331**

(N805995-S100,  
W701566-S417)

Diameter: 1/4"  
Grip: 1/32"-7/32"  
Flange Diameter: 3/4"  
Aluminum Rivet (Black)  
Aluminum Mandrel (Yellow)  
Attachment Of Power Door Lock  
Actuator  
Mustang & Lincoln  
Continental 1994-On

UNIT PACKAGE: 10

**SPECIALTY RIVETS**

Rivets Are Listed In Columns By Diameter Then By Flange Diameter & Lastly By Minimum Grip



**17640**  
(3540146,  
3548011)

1/4" Diameter  
Grip: .070"-.083"  
Flange Diameter: 3/4"  
Steel Rivet  
Steel Mandrel (Zinc & Yellow  
Dichromate)  
Front Door Window  
Channel Retainer Rivet  
Buick Riviera, Cadillac DeVille &  
Eldorado And Olds Toronado  
1993-On

UNIT PACKAGE: 15



**19509**  
(388442-S309)

1/4" Diameter  
Grip: 1/8"-1/4"  
Flange Diameter: 3/4"  
Steel Rivet (Zinc)  
Steel Mandrel (Zinc)  
Front Bumper  
Ford Trucks E150/350 &  
F150/250  
1997-On

UNIT PACKAGE: 15



**19796**  
(9441955)

1/4" Diameter  
Grip: 1/4"-3/8"  
Flange Diameter: 3/4"  
Steel Rivet (Zinc)  
Steel Mandrel (Zinc)  
Front & Rear Bumpers  
Buick Regal &  
Rivera, Chevrolet Camaro  
& Lumina,  
Oldsmobile Aurora,  
Pontiac 6000, Firebird,  
Le Mans & Trans Am  
1989-On

UNIT PACKAGE: 25



**12652**  
(388442-S100)

Dia: 1/4"  
Grip: 1/8"-1/4"  
Flange Dia: 3/4"  
Steel Rivet (Black)  
Steel Mandrel  
Bumper Assembly  
Escort & Lynx 1981-On

UNIT PACKAGE: 25



**20413**  
(N811090-S100)

1/4" Diameter  
Grip: 1/2" - 5/8"  
Flange Diameter: 3/4"  
Steel Rivet (Zinc)  
Steel Mandrel (Zinc & Yellow)  
Brake Rotors & General Purpose  
Lincoln Town Car,  
Ford Crown Vic  
& Mercury Grand Marquis  
1999 - On

UNIT PACKAGE: 10

**HIGH SPEED JOBBER LENGTH DRILLS**



**Straight Shank - Black Finish  
135° Split Point**

Auveco Part No.	Unit Pkg.	Size	Dec. Equiv.	Flute Length	Overall Length
13039	5	3/32"	.0938	1-1/4"	2-1/4"
13040	5	7/64"	.1094	1-1/2"	2-5/8"
13041	5	1/8"	.1250	1-5/8"	2-3/4"
13095	5	3/16"	.1285	1-5/8"	2-3/4"
13042	5	9/64"	.1406	1-3/4"	2-7/8"
13043	5	5/32"	.1562	2"	3-1/8"
13044	5	11/64"	.1719	2-1/8"	3-1/4"
13080	5	15/64"	.1800	2-3/16"	3-3/8"
13045	5	3/16"	.1875	2-5/16"	3-1/2"
13077	5	12/64"	.1890	2-5/16"	3-1/2"
13075	5	10/64"	.1935	2-7/16"	3-5/8"
13072	5	7/32"	.2010	2-7/16"	3-5/8"
13095	5	3/16"	.1285	1-5/8"	2-3/4"
13046	5	13/64"	.2031	2-7/16"	3-5/8"
13047	5	7/32"	.2188	2-1/2"	3-3/4"
13048	5	15/64"	.2344	2-5/8"	3-7/8"
13049	5	1/4"	.2500	2-3/4"	4"
13050	5	17/64"	.2656	2-7/8"	4-1/8"
13051	5	9/32"	.2812	2-15/16"	4-1/4"
13052	5	19/64"	.2969	3-1/16"	4-3/8"
13053	5	5/16"	.3125	3-3/16"	4-1/2"
13054	5	21/64"	.3281	3-5/16"	4-5/8"
13055	5	11/32"	.3438	3-7/16"	4-3/4"
13056	5	23/64"	.3594	3-1/2"	4-7/8"
13057	5	3/8"	.3750	3-5/8"	5"
13058	5	25/64"	.3906	3-3/4"	5-1/8"
13059	5	13/32"	.4062	3-7/8"	5-1/4"
13060	5	27/64"	.4219	3-15/16"	5-3/8"
13061	5	7/16"	.4375	4-1/16"	5-1/2"
13062	5	29/64"	.4531	4-3/16"	5-5/8"
13063	5	15/32"	.4688	4-5/16"	5-3/4"
13064	5	31/64"	.4844	4-3/8"	5-7/8"
13065	3	1/2"	.5000	4-1/2"	6"



**Masonry Drills  
Chrome Finish - Carbide Tipped  
M2 High Speed Steel - ASA Standard**

Auveco Part No.	Unit Pkg.	Size	Shank Size	Overall Length
13106	3	3/16"	11/64"	3"
13108	3	1/4"	7/32"	6"

**COBALT STEEL SPOT WELD DRILLS**



Auveco Part No.	Unit Pkg.	Size	Flute Length	Overall Length
20479	3	8mm (5/16")	27mm (1-1/16")	58mm (2-1/4")
20480	3	10mm (3/8")	27mm (1-1/16")	58mm (2-1/4")

**Sec. 14**

**HIGH SPEED JOBBER LENGTH DRILL SETS**  
Plastic Indexes

**13140**

Jobbers Length, Straight Shank  
135° Split Point, Blue/Bright Finish  
Sizes 1/16" thru 1/4" by 64ths - 13 Pieces

UNIT PACKAGE: 1 Set



**High Speed Jobber Length Drill Sets**

Metal Drill Indexes



**13136**

Jobbers Length  
Straight Shank 135°  
Split Point  
Blue/Bright Finish  
Sizes 1/16" thru  
1/2" by 64th  
29 Pieces

UNIT PACKAGE: 1 Set

**13138**

Jobbers Length  
118° Standard Point  
Blue Finish  
Sizes 1/16" thru 1/2" by 64th with 1/4" Shanks  
on Sizes 1/4" and Larger - 29 Pieces

UNIT PACKAGE: 1 Set



**Screw Machine Length Drills**  
**Blue Finish - Straight Shank**  
**135° Split Point**

Auveco Part No.	Unit Pkg.	Size	Dec. Equiv.	Flute Length	Overall Length
<b>13120</b>	5	1/16"	.0625	5/8"	1-5/8"
<b>13121</b>	5	5/64"	.0781	11/16"	1-11/16"
<b>13122</b>	5	3/32"	.0938	3/4"	1-3/4"
<b>13124**</b>	5	1/8"	.1250	7/8"	1-7/8"
<b>13127</b>	5	11/64"	.1719	1-1/16"	2-1/8"
<b>13128</b>	5	3/16"	.1875	1-1/8"	2-3/16"
<b>13132</b>	5	1/4"	.2500	1-3/8"	2-1/2"
<b>13133</b>	5	5/16"	.3125	1-5/8"	2-13/16"
<b>13134</b>	2	3/8"	.3750	1-13/16"	3-1/8"

\*\* - for 1/8" Pop Rivets

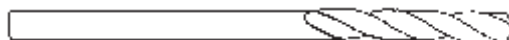

**135° Split Point**  
**For use w/ Auveco Pan'l Rivets**

Auveco Part No.	Decimal Size	Fractional Equivalent	Unit Pkg.
<b>9316</b> .....	.125 .....	1/8" .....	12
<b>9317</b> .....	.1285 .....	1/8" .....	12



Double-End Drill Bit  
1/8" (.125) Dia., 2" Length  
135° Split Point

**12676**  
Black Finish  
UNIT PKG: 5

# AuvecoPak AP256 RETAIL MERCHANDISER

**NOTE:** The AuvecoPak part number is the same as the standard Auveco part number with an "AP" prefix. Thus AP11146 is the AuvecoPak version of 11146.



**Note: Gondola Is Not Included**

Refer to the color pages in the front of the catalog for a better view of the merchandiser and individual bags.

The **AuvecoPak AP256** provides a Jobber with 256 of the fastest moving, most popular automotive body hardware and specialty fastener items in a **one-price bag** all on one 4-panel merchandiser. Each panel contains two bags each of 32 part numbers per side for a **total of 512 bags**. The attractive green AuvecoPak bags feature eye-appealing, contemporary graphics with all the necessary application and descriptive information in **trilingual verbiage** (English, Spanish and French-Canadian).

Initial set-up is as easy as 1-2-3 since the panels come "**pre-dressed**" with the AuvecoPaks already in place. Simply position the top and bottom brackets on a gondola. Insert the panels into the brackets and you're ready for business. An individual panel measures 6-1/2" (wide) x 17-1/2" (front to back) x 44-1/2" (high). The AuvecoPak AP256 4-panel merchandiser fits on a 48" x 48" gondola or on any pegboard wall. **A gondola is not included as part of the merchandiser.**

Re-order information, including the AuvecoPak part number and a **UPC-A bar code**, appears on the panel back-up boards beneath each hook. Restocking the merchandiser is also quick and easy since the AuvecoPak bags contain locator codes that identify their specific location on the panels.

## EXAMPLE OF TYPICAL AuvecoPak BAG

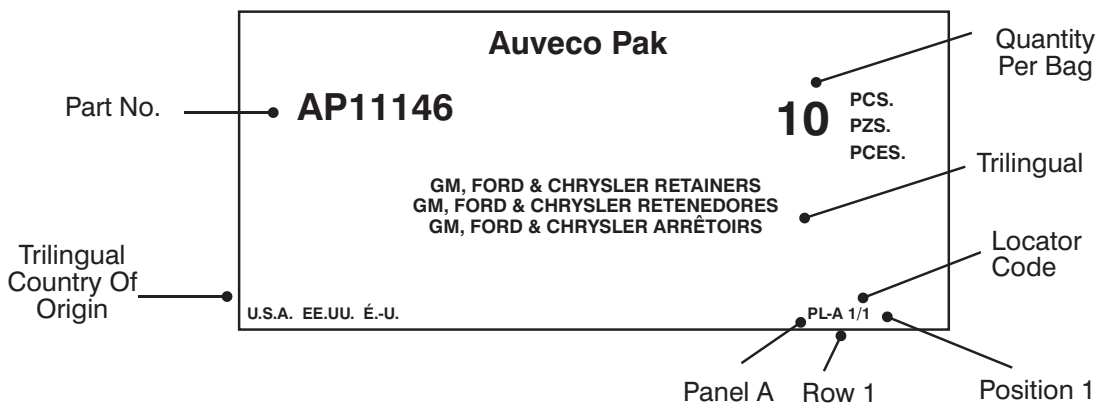

# Sec. 15

## AuvecoPak AP256 RETAIL MERCHANDISER CONTENTS

**NOTE: The AuvecoPak part number is the same as the standard Auveco part number with an "AP" prefix. Thus AP11146 is the AuvecoPak version of 11146.**

### PANEL A Retainers

AP11146	AP10831	AP10832	AP17664
AP11120	AP14921	AP14021	AP11612
AP11721	AP15367	AP17612	AP11679
AP16818	AP12731	AP14032	AP14036
AP12766	AP15543	AP20316	AP11351
AP12137	AP15481	AP15480	AP12571
AP12909	AP15479	AP15457	AP12759
AP15456	AP11130	AP19386	AP18915

### PANEL B Retainers

AP12565	AP13470	AP11671	AP11797
AP17075	AP19270	AP16695	AP15970
AP12992	AP15461	AP11678	AP13461
AP10621	AP12737	AP11796	AP17339
AP18877	AP18033	AP14328	AP10744
AP8853	AP18114	AP19114	AP14291
AP18297	AP14736	AP14737	AP17975
AP14738	AP19655	AP17004	AP14163

### PANEL C Push-Type Retainers

AP12567	AP14011	AP19239	AP19118
AP16782	AP11706	AP14010	AP12757
AP14697	AP14696	AP14260	AP16007
AP17379	AP17632	AP17267	AP16858
AP17439	AP14992	AP14753	AP17472
AP17057	AP17143	AP16835	AP18119
AP17144	AP18353	AP14016	AP19233
AP17222	AP13993	AP17216	AP13996

### PANEL D Push-Type Retainers & Rivets

AP18873	AP19422	AP14019	AP14020
AP13748	AP13755	AP13751	AP13750
AP14023	AP13752	AP13753	AP12655
AP11620	AP11621	AP12658	AP12653
AP18167	AP16834	AP18304	AP17006
AP16864	AP14127	AP5753	AP8880
AP8309	AP8925	AP8931	AP16032
AP16031	AP8311	AP8301	AP8313

### PANEL E Tapping Screws & Body Bolts

AP12215	AP12216	AP12953	AP12954
AP12060	AP17650	AP12820	AP12957
AP11788	AP11789	AP11791	AP11792
AP10165	AP10167	AP10181	AP10182
AP15775	AP15373	AP11922	AP11923
AP12324	AP12160	AP12065	AP12066
AP11633	AP12348	AP13614	AP9480
AP10362	AP11320	AP5711	AP11110

### PANEL F Tapping Screws & Body Bolts

AP16421	AP12351	AP11369	AP9603
AP14473	AP16826	AP2775	AP2751
AP2772	AP3466	AP3467	AP10642
AP2805	AP12095	AP13708	AP15172
AP2806	AP13027	AP2710	AP1799
AP2713	AP1483	AP1717	AP2730
AP9615	AP11914	AP8443	AP11297
AP9355	AP3099	AP3102	AP12660

### PANEL G Nuts: "U", Tubular & Thread Cutting

AP8359	AP10051	AP10053	AP8814
AP10054	AP10055	AP12669	AP12575
AP16322	AP11628	AP11629	AP11630
AP11631	AP10064	AP10065	AP9880
AP9879	AP10066	AP10666	AP13225
AP11292	AP5197	AP2293	AP2099
AP2595	AP10073	AP3403	AP3404
AP2896	AP3405	AP10733	AP2288

### PANEL H Nylon Nuts, Shims & Specialty Items

AP13232	AP11691	AP9862	AP13932
AP13933	AP11719	AP8435	AP14267
AP2744	AP19626	AP2619	AP2752
AP19378	AP8941	AP11067	AP9639
AP11152	AP14550	AP14553	AP14559
AP11243	AP11826	AP11655	AP11848
AP11863	AP2310	AP3155	AP3156
AP8863	AP8865	AP19916	AP19922

**AuvecoPak AP256 RETAIL MERCHANDISER CONTENTS  
PART NUMBER LOCATION CHART**

<b>Auveco Pak No.</b>	<b>Location</b>			<b>Auveco Pak No.</b>	<b>Location</b>		
AP1483	Panel-F	Row 6	Position 2	AP10165	Panel-E	Row 4	Position 1
AP1717	Panel-F	Row 6	Position 3	AP10167	Panel-E	Row 4	Position 2
AP1799	Panel-F	Row 5	Position 4	AP10181	Panel-E	Row 4	Position 3
AP2099	Panel-G	Row 6	Position 4	AP10182	Panel-E	Row 4	Position 4
AP2288	Panel-G	Row 8	Position 4	AP10362	Panel-E	Row 8	Position 1
AP2293	Panel-G	Row 6	Position 3	AP10621	Panel-B	Row 4	Position 1
AP2310	Panel-H	Row 7	Position 2	AP10642	Panel-F	Row 3	Position 4
AP2595	Panel-G	Row 7	Position 1	AP10666	Panel-G	Row 5	Position 3
AP2619	Panel-H	Row 3	Position 3	AP10733	Panel-G	Row 8	Position 3
AP2710	Panel-F	Row 5	Position 3	AP10744	Panel-B	Row 5	Position 4
AP2713	Panel-F	Row 6	Position 1	AP10831	Panel-A	Row 1	Position 2
AP2730	Panel-F	Row 6	Position 4	AP10832	Panel-A	Row 1	Position 3
AP2744	Panel-H	Row 3	Position 1	AP11067	Panel-H	Row 4	Position 3
AP2751	Panel-F	Row 2	Position 4	AP11110	Panel-E	Row 8	Position 4
AP2752	Panel-H	Row 3	Position 4	AP11120	Panel-A	Row 2	Position 1
AP2772	Panel-F	Row 3	Position 1	AP11130	Panel-A	Row 8	Position 2
AP2775	Panel-F	Row 2	Position 3	AP11146	Panel-A	Row 1	Position 1
AP2805	Panel-F	Row 4	Position 1	AP11152	Panel-H	Row 5	Position 1
AP2806	Panel-F	Row 5	Position 1	AP11243	Panel-H	Row 6	Position 1
AP2896	Panel-G	Row 8	Position 1	AP11292	Panel-G	Row 6	Position 1
AP3099	Panel-F	Row 8	Position 2	AP11297	Panel-F	Row 7	Position 4
AP3102	Panel-F	Row 8	Position 3	AP11320	Panel-E	Row 8	Position 2
AP3155	Panel-H	Row 7	Position 3	AP11351	Panel-A	Row 5	Position 4
AP3156	Panel-H	Row 7	Position 4	AP11369	Panel-F	Row 1	Position 3
AP3403	Panel-G	Row 7	Position 3	AP11612	Panel-A	Row 2	Position 4
AP3404	Panel-G	Row 7	Position 4	AP11620	Panel-D	Row 4	Position 1
AP3405	Panel-G	Row 8	Position 2	AP11621	Panel-D	Row 4	Position 2
AP3466	Panel-F	Row 3	Position 2	AP11628	Panel-G	Row 3	Position 2
AP3467	Panel-F	Row 3	Position 3	AP11629	Panel-G	Row 3	Position 3
AP5197	Panel-G	Row 6	Position 2	AP11630	Panel-G	Row 3	Position 4
AP5711	Panel-E	Row 8	Position 3	AP11631	Panel-G	Row 4	Position 1
AP5753	Panel-D	Row 6	Position 3	AP11633	Panel-E	Row 7	Position 1
AP8301	Panel-D	Row 8	Position 3	AP11655	Panel-H	Row 6	Position 3
AP8309	Panel-D	Row 7	Position 1	AP11671	Panel-B	Row 1	Position 3
AP8311	Panel-D	Row 8	Position 2	AP11678	Panel-B	Row 3	Position 3
AP8313	Panel-D	Row 8	Position 4	AP11679	Panel-A	Row 3	Position 4
AP8359	Panel-G	Row 1	Position 1	AP11691	Panel-H	Row 1	Position 2
AP8435	Panel-H	Row 2	Position 3	AP11706	Panel-C	Row 2	Position 2
AP8443	Panel-F	Row 7	Position 3	AP11719	Panel-H	Row 2	Position 2
AP8814	Panel-G	Row 1	Position 4	AP11721	Panel-A	Row 3	Position 1
AP8853	Panel-B	Row 6	Position 1	AP11788	Panel-E	Row 3	Position 1
AP8863	Panel-H	Row 8	Position 1	AP11789	Panel-E	Row 3	Position 2
AP8865	Panel-H	Row 8	Position 2	AP11791	Panel-E	Row 3	Position 3
AP8880	Panel-D	Row 6	Position 4	AP11792	Panel-E	Row 3	Position 4
AP8925	Panel-D	Row 7	Position 2	AP11796	Panel-B	Row 4	Position 3
AP8931	Panel-D	Row 7	Position 3	AP11797	Panel-B	Row 1	Position 4
AP8941	Panel-H	Row 4	Position 2	AP11826	Panel-H	Row 6	Position 2
AP9355	Panel-F	Row 8	Position 1	AP11848	Panel-H	Row 6	Position 4
AP9480	Panel-E	Row 7	Position 4	AP11863	Panel-H	Row 7	Position 1
AP9603	Panel-F	Row 1	Position 4	AP11914	Panel-F	Row 7	Position 2
AP9615	Panel-F	Row 7	Position 1	AP11922	Panel-E	Row 5	Position 3
AP9639	Panel-H	Row 4	Position 4	AP11923	Panel-E	Row 5	Position 4
AP9862	Panel-H	Row 1	Position 3	AP12060	Panel-E	Row 2	Position 1
AP9879	Panel-G	Row 5	Position 1	AP12065	Panel-E	Row 6	Position 3
AP9880	Panel-G	Row 4	Position 4	AP12066	Panel-E	Row 6	Position 4
AP10051	Panel-G	Row 1	Position 2	AP12095	Panel-F	Row 4	Position 2
AP10053	Panel-G	Row 1	Position 3	AP12137	Panel-A	Row 6	Position 1
AP10054	Panel-G	Row 2	Position 1	AP12160	Panel-E	Row 6	Position 2
AP10055	Panel-G	Row 2	Position 2	AP12215	Panel-E	Row 1	Position 1
AP10064	Panel-G	Row 4	Position 2	AP12216	Panel-E	Row 1	Position 2
AP10065	Panel-G	Row 4	Position 3	AP12324	Panel-E	Row 6	Position 1
AP10066	Panel-G	Row 5	Position 2	AP12348	Panel-E	Row 7	Position 2
AP10073	Panel-G	Row 7	Position 2	AP12351	Panel-F	Row 1	Position 2

**AuvecoPak AP256 CONTENTS (Continued)**

<b>Auveco Pak No.</b>	<b>Location</b>			<b>Auveco Pak No.</b>	<b>Location</b>		
AP12565	Panel-B	Row 1	Position 1	AP15367	Panel-A	Row 3	Position 2
AP12567	Panel-C	Row 1	Position 1	AP15373	Panel-E	Row 5	Position 2
AP12571	Panel-A	Row 6	Position 4	AP15456	Panel-A	Row 8	Position 1
AP12575	Panel-G	Row 2	Position 4	AP15457	Panel-A	Row 7	Position 3
AP12653	Panel-D	Row 4	Position 4	AP15461	Panel-B	Row 3	Position 2
AP12655	Panel-D	Row 3	Position 4	AP15479	Panel-A	Row 7	Position 2
AP12658	Panel-D	Row 4	Position 3	AP15480	Panel-A	Row 6	Position 3
AP12660	Panel-F	Row 8	Position 4	AP15481	Panel-A	Row 6	Position 2
AP12669	Panel-G	Row 2	Position 3	AP15543	Panel-A	Row 5	Position 2
AP12731	Panel-A	Row 4	Position 2	AP15775	Panel-E	Row 5	Position 1
AP12737	Panel-B	Row 4	Position 2	AP15970	Panel-B	Row 2	Position 4
AP12757	Panel-C	Row 2	Position 4	AP16000	Panel-C	Row 3	Position 4
AP12759	Panel-A	Row 7	Position 4	AP16031	Panel-D	Row 8	Position 1
AP12766	Panel-A	Row 5	Position 1	AP16032	Panel-D	Row 7	Position 4
AP12820	Panel-E	Row 2	Position 3	AP16322	Panel-G	Row 3	Position 1
AP12909	Panel-A	Row 7	Position 1	AP16421	Panel-F	Row 1	Position 1
AP12953	Panel-E	Row 1	Position 3	AP16695	Panel-B	Row 2	Position 3
AP12954	Panel-E	Row 1	Position 4	AP16782	Panel-C	Row 2	Position 1
AP12957	Panel-E	Row 2	Position 4	AP16818	Panel-A	Row 4	Position 1
AP12992	Panel-B	Row 3	Position 1	AP16826	Panel-F	Row 2	Position 2
AP13027	Panel-F	Row 5	Position 2	AP16834	Panel-D	Row 5	Position 2
AP13225	Panel-G	Row 5	Position 4	AP16835	Panel-C	Row 6	Position 3
AP13232	Panel-H	Row 1	Position 1	AP16858	Panel-C	Row 4	Position 4
AP13461	Panel-B	Row 3	Position 4	AP16864	Panel-D	Row 6	Position 1
AP13470	Panel-B	Row 1	Position 2	AP17004	Panel-B	Row 8	Position 3
AP13614	Panel-E	Row 7	Position 3	AP17006	Panel-D	Row 5	Position 4
AP13708	Panel-F	Row 4	Position 3	AP17057	Panel-C	Row 6	Position 1
AP13748	Panel-D	Row 2	Position 1	AP17075	Panel-B	Row 2	Position 1
AP13750	Panel-D	Row 2	Position 4	AP17143	Panel-C	Row 6	Position 2
AP13751	Panel-D	Row 2	Position 3	AP17144	Panel-C	Row 7	Position 1
AP13752	Panel-D	Row 3	Position 2	AP17216	Panel-C	Row 8	Position 3
AP13753	Panel-D	Row 3	Position 3	AP17222	Panel-C	Row 8	Position 1
AP13755	Panel-D	Row 2	Position 2	AP17267	Panel-C	Row 4	Position 3
AP13932	Panel-H	Row 1	Position 4	AP17339	Panel-B	Row 4	Position 4
AP13933	Panel-H	Row 2	Position 1	AP17379	Panel-C	Row 4	Position 1
AP13993	Panel-C	Row 8	Position 2	AP17439	Panel-C	Row 5	Position 1
AP13996	Panel-C	Row 8	Position 4	AP17472	Panel-C	Row 5	Position 4
AP14010	Panel-C	Row 2	Position 3	AP17612	Panel-A	Row 3	Position 3
AP14011	Panel-C	Row 1	Position 2	AP17632	Panel-C	Row 4	Position 2
AP14016	Panel-C	Row 7	Position 3	AP17650	Panel-E	Row 2	Position 2
AP14019	Panel-D	Row 1	Position 3	AP17664	Panel-A	Row 1	Position 4
AP14020	Panel-D	Row 1	Position 4	AP17975	Panel-B	Row 7	Position 4
AP14021	Panel-A	Row 2	Position 3	AP18033	Panel-B	Row 5	Position 2
AP14023	Panel-D	Row 3	Position 1	AP18114	Panel-B	Row 6	Position 2
AP14032	Panel-A	Row 4	Position 3	AP18119	Panel-C	Row 6	Position 4
AP14036	Panel-A	Row 4	Position 4	AP18167	Panel-D	Row 5	Position 1
AP14127	Panel-D	Row 6	Position 2	AP18297	Panel-B	Row 7	Position 1
AP14163	Panel-B	Row 8	Position 4	AP18304	Panel-D	Row 5	Position 3
AP14260	Panel-C	Row 3	Position 3	AP18353	Panel-C	Row 7	Position 2
AP14267	Panel-H	Row 2	Position 4	AP18873	Panel-D	Row 1	Position 1
AP14291	Panel-B	Row 6	Position 4	AP18877	Panel-B	Row 5	Position 1
AP14328	Panel-B	Row 5	Position 3	AP18915	Panel-A	Row 8	Position 4
AP14473	Panel-F	Row 2	Position 1	AP19114	Panel-B	Row 6	Position 3
AP14550	Panel-H	Row 5	Position 2	AP19118	Panel-C	Row 1	Position 4
AP14553	Panel-H	Row 5	Position 3	AP19233	Panel-C	Row 7	Position 4
AP14559	Panel-H	Row 5	Position 4	AP19239	Panel-C	Row 1	Position 3
AP14696	Panel-C	Row 3	Position 2	AP19270	Panel-B	Row 2	Position 2
AP14697	Panel-C	Row 3	Position 1	AP19378	Panel-H	Row 4	Position 1
AP14736	Panel-B	Row 7	Position 2	AP19386	Panel-A	Row 8	Position 3
AP14737	Panel-B	Row 7	Position 3	AP19422	Panel-D	Row 1	Position 2
AP14738	Panel-B	Row 8	Position 1	AP19626	Panel-H	Row 3	Position 2
AP14753	Panel-C	Row 5	Position 3	AP19655	Panel-B	Row 8	Position 2
AP14921	Panel-A	Row 2	Position 2	AP19916	Panel-H	Row 8	Position 3
AP14992	Panel-C	Row 5	Position 2	AP19922	Panel-H	Row 8	Position 4
AP15172	Panel-F	Row 4	Position 4	AP20316	Panel-A	Row 5	Position 3



# BODY HARDWARE MASTER ASSORTMENTS

(6000 & 6500 Series Fix-Kits are listed on pages 280 - 300)

**A Great Introduction to Prospective Accounts or an Exciting New Program to Increase Sales at Existing Customers**

**Free Cabinet (\$109.55 Resale Value)**  
when you buy  
4 different assortments

**The Most Popular Body Hardware & Specialty Fasteners**



Based on Auveco's very popular **DB-370 Plus Display Boards**, we have developed **18** different large metal drawer assortments. These assortments contain 371 of the most popular domestic and foreign Body Hardware Clips and Fasteners. Each drawer is set up to accommodate the Auveco unit package quantity - **no more problems with refills.**

**Part No. 6650BHM:** Buy a combination of any four different 6600BHM series individual drawer assortments and you'll receive one **FREE 2-96** four drawer cabinet (a **\$109.55 savings for the Collision Shop.**)



### 6601BHM

Small Retainers & Retaining Clips  
23 varieties, 1085 pieces

Contains the following Auveco part numbers:  
10621, 10831, 11612, 11796,  
12565, 12737, 12992, 13470,  
14021, 14291, 14328, 14736,  
14737, 15367, 15414, 15970,  
16818, 17339, 17664, 18114,  
18297, 18877 & 19114



### 6602BHM

Large Retainers  
19 varieties, 640 pieces

Contains the following Auveco part numbers:  
11130, 11136, 12137, 12571,  
12731, 12759, 12766, 12909,  
14036, 14163, 14738 15456,  
15479, 15543, 15998, 17004,  
17612, 17975 & 19655



### 6603BHM

Push-Type Retainers & Trim Panel Fasteners  
24 varieties, 545 pieces

Contains the following Auveco part numbers:  
11863, 12134, 14260, 14753,  
14992, 14997, 16000, 16858,  
17057, 17143, 17144, 17222,  
17267, 17379, 17472, 17632,  
18119, 19118, 19233, 19239,  
19246, 19274, 19453 & 20247

## Sec. 15

# BODY HARDWARE MASTER ASSORTMENTS



### 6604BHM

Push-Type Retainers,  
Rubber Caps, Hole Plugs  
& Wire Loom Clips  
23 varieties, 737 pieces

Contains the following  
Auveco part numbers:  
4439, 4440, 9288, 11746, 12209,  
12210, 12567, 12757, 12907,  
12908, 13993, 13996, 14010,  
14011, 14019, 14020, 14545,  
14546, 14547, 17216, 18353,  
18873 & 19422

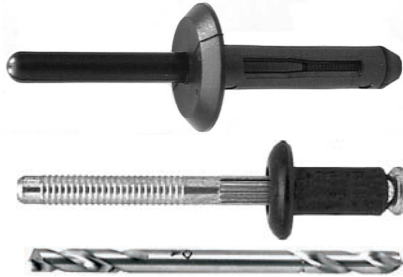

### 6605BHM

Nylon Rivets, Specialty Rivets &  
Double End Drill  
23 varieties, 660 pieces

Contains the following  
Auveco part numbers:  
12652, 12653, 12655, 12658,  
12676, 13748, 13750, 13751,  
13753, 13755, 14023, 14127,  
16834, 16837, 16838, 16864,  
17006, 17121, 17410, 17639,  
18108, 18167 & 19376



### 6606BHM

Pan'l Blind Rivets,  
Moulding Clips &  
Universal Moulding Fasteners  
22 varieties, 1120 pieces

Contains the following  
Auveco part numbers:  
2619, 2744, 2752, 8301, 8311, 8313,  
8925, 8931, 8941, 9633, 9749, 9965,  
14642, 16865, 19115, 19378, 19415,  
19626, 19752, 20390, 20391  
& 20392



### 6607BHM

Phillips Oval Head,  
Phillips Pan Head &  
Specialty Tapping Screws  
(Chrome & Zinc)  
23 varieties, 2350 pieces

Contains the following  
Auveco part numbers:  
1423, 1483, 1717, 1794, 1796,  
1799, 1940, 1943, 2027, 2365,  
2366, 2367, 2710, 2713, 2728,  
2730, 2731, 3079, 3090, 9603,  
9605, 12095 & 15172

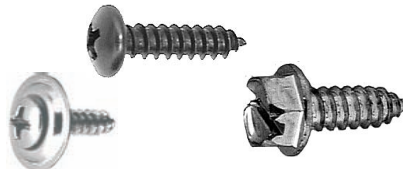

### 6608BHM

Phillips Oval Hd. Sems (Chrome),  
Phillips Pan Hd. (Black Oxide) &  
Hex Hd. (Zinc) Tapping Screws  
24 varieties, 1925 pieces

Contains the following  
Auveco part numbers:  
2751, 2772, 2773, 2775, 3466,  
3467, 9611, 9615, 10180,  
10181, 10182, 11369, 11450,  
11451, 11914, 11917, 11921,  
11922, 11923, 12799, 15170,  
16828, 16960 & 17098

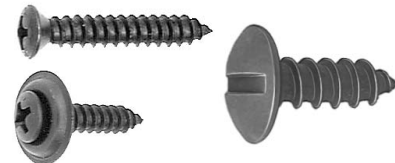

### 6609BHM

Phillips Oval Hd. (Black Oxide) &  
Phillips Pan Hd. Sems (Bk. Phos.)  
Tapping Screws  
23 varieties, 2025 pieces

Contains the following  
Auveco part numbers:  
10162, 10164, 10165, 10166,  
10167, 10168, 11086, 11087,  
11088, 11089, 11455, 11456,  
11788, 11789, 11790, 11791,  
11792, 12796, 12797, 12820,  
12957, 16323 & 20259



### 6610BHM

Phillips Flat Top Washer Hd. (Black),  
Hex Head Sems (Black) & Hex  
Slotted Hd. (Black) Tapping Screws  
22 varieties, 1700 pieces

Contains the following  
Auveco part numbers:  
12060, 12213, 12214, 12215,  
12216, 12217, 12218, 12339,  
12351, 12738, 12742, 12953,  
12954, 13026, 15373, 15774,  
15775, 16421, 17459, 17650,  
18340 & 18354

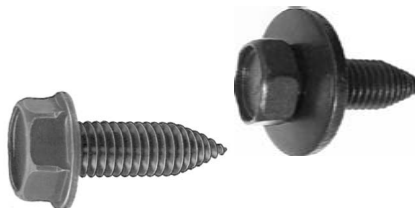

### 6611BHM

Hex Head Sems & Hex Washer Hd.  
Body Bolts (Black)  
21 varieties, 810 pieces

Contains the following  
Auveco part numbers:  
9480, 10362, 10823, 11109,  
11110, 11320, 11641, 12065,  
12066, 12160, 12232, 12324,  
12336, 12343, 12693, 13613,  
13614, 13618, 13619, 18416  
& 18769

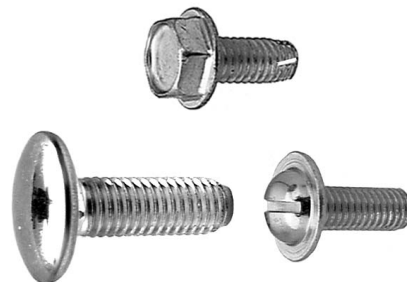

### 6612BHM

Hex Head Sems & Hex Washer Hd.  
Body Bolts (Zinc) & Bumper Bolts  
11 varieties, 430 pieces

Contains the following  
Auveco part numbers:  
4474, 5242, 5246, 8443, 11295,  
12335, 14473, 14976, 16826,  
16986 & 17316

**BODY HARDWARE MASTER ASSORTMENTS**



**6613BHM**

Spin Lock Nuts, Hex Flange Nuts, Free Spinning Washer Nuts, Jack Nuts & Well Nuts  
22 varieties, 690 pieces

Contains the following Auveco part numbers:  
11644, 11645, 12595, 12596, 12995, 12999, 13004, 13007, 13008, 13009, 13010, 13014, 13016, 14855, 15326, 15329, 15334, 15335, 16470, 16769, 16830 & 16883



**6614BHM**

"J" Nuts, Spring Type "U" Nuts & Extruded "U" Nuts  
23 varieties, 965 pieces

Contains the following Auveco part numbers:  
5586, 5589, 8359, 8814, 9879, 9880, 10051, 10053, 10054, 10055, 10064, 10065, 10066, 10067, 11628, 11629, 11630, 11631, 12575, 12669, 14750, 15677 & 15752



**6615BHM**

Flat Nuts, Tubular Nuts & Shims  
11 varieties, 950 pieces

Contains the following Auveco part numbers:  
1903, 2089, 2099, 2293, 2595, 3155, 3156, 5076, 5077, 5196 & 11292



**6616BHM**

Washer Lock Nuts, Thread Cutting Nuts, Push-On Retainers & Pushnut Bolt Retainers  
23 varieties, 2300 pieces

Contains the following Auveco part numbers:  
2555, 2557, 2896, 2897, 3404, 3405, 8863, 8864, 8865, 8868, 8869, 9297, 9299, 10086, 10087, 10374, 10733, 12123, 12127, 12253, 12255, 12259 & 14980



**6617BHM**

Nylon Nuts & Specialty Metal Fasteners  
22 varieties, 880 pieces

Contains the following Auveco part numbers:  
3682, 8435, 9829, 9862, 11368, 11691, 11719, 13450, 13932, 13933, 13960, 14031, 14267, 14268, 14274, 14275, 14695, 18153, 18262, 18816, 19194 & 19339



**6618BHM**

Door Hinge Pins & Bushings, Headlight Adjusting Screw Assemblies, Headlight Component Retaining Clips, Door Lock Rod Clips, Window Crank Handle Retaining Clips & Cable Straps  
12 varieties, 309 pieces

Contains the following Auveco part numbers:  
2288, 3178, 11243, 14298, 14550, 14553, 14559, 15518, 15940, 16936, 16937, & 19424

## SMALL EMPTY DRAWERS AND CABINETS

Cabinet and drawers with plastic inserts are sturdily built of heavy gauge steel. The Kits are designed with scoop compartments and slide easily on the cabinet slide. All items are available in Unit Packages. For refills, order by Auveco number on lid label.



**6-60 Cabinet & 6 Empty Small Drawers**  
 (24 Compartment Drawers With Locking Latches)  
 15-1/4" W x 11-3/4" D x 16-3/8" H  
 Finish: Light Green Enamel  
 Drawer Size: 13-5/16" Wide x 9-1/4" Deep x 2" High

**3-60 Empty Cabinet.** Holds 6 Small Drawers

**4-60 Empty Cabinet.** Will Hold 4 Small Drawers.  
 15-1/4" Wide x 11-3/4" Deep x 10-3/4" High  
 Finish: Light Green Enamel  
 Drawer Size: Same as the 6-60



**Empty Drawers** (13-5/16" Wide x 9-1/4" Deep x 2" High) Are Available  
 In 8, 12, 16, 20, 21 And 24 Compartment Layouts:

- |              |  |
|--------------|--|
| <b>2-608</b> | 8 Compartment Empty Drawer With Locking Latch  |
| <b>2-612</b> | 12 Compartment Empty Drawer With Locking Latch |
| <b>2-616</b> | 16 Compartment Empty Drawer With Locking Latch |
| <b>2-620</b> | 20 Compartment Empty Drawer With Locking Latch |
| <b>2-621</b> | 21 Compartment Empty Drawer With Locking Latch |
| <b>2-624</b> | 24 Compartment Empty Drawer With Locking Latch |

# LARGE EMPTY DRAWERS AND CABINETS



**4-96 Cabinet & 4 Empty Large Drawers**  
 (24 Compartment Drawers With Locking Latches).  
 20" Wide x 15-3/4" Deep x 14-1/2" High  
 Finish: Light Green Enamel  
 Drawer Size: 18" Wide x 12" Deep x 3" High

**2-96 Empty Cabinet.** Will Hold 4 Large Drawers



**3-96 Empty Cabinet.** Will Hold 2 Large Drawers.  
 20" Wide x 15-3/4" Deep x 8" High  
 Finish: Light Green Enamel  
 Drawer Size: Same As 4-96

**Base B-3 for cabinets 2-96, 3-96 and 4-96 is pictured on page 293**



No. 1-924



No. 1-901



No. 1-900

Empty Drawers With Locking Latches (18" Wide x 12" Deep x 3" High) Are Available In 12, 16, 20, 21, 24, and 32 Compartment Layouts:

<p><b>1-900</b> Adjustable Compartment Empty Drawer with 3 Vertical &amp; 3 Horizontal Dividers</p> <p><b>1-901</b> Adjustable Compartment Empty Drawer with 9 dividers.</p> <p><b>1-912</b> 12 Compartment Empty Drawer</p>	<p><b>1-916</b> 16 Compartment Empty Drawer</p> <p><b>1-920</b> 20 Compartment Empty Drawer</p> <p><b>1-921</b> 21 Compartment Empty Drawer</p> <p><b>1-924</b> 24 Compartment Empty Drawer</p> <p><b>1-932</b> 32 Compartment Empty Drawer</p>	<p><b>1-916</b> 16 Compartment Empty Drawer</p> <p><b>1-920</b> 20 Compartment Empty Drawer</p> <p><b>1-921</b> 21 Compartment Empty Drawer</p> <p><b>1-924</b> 24 Compartment Empty Drawer</p> <p><b>1-932</b> 32 Compartment Empty Drawer</p>
--	---	---

**“FIX-KIT”® LID LABELS**

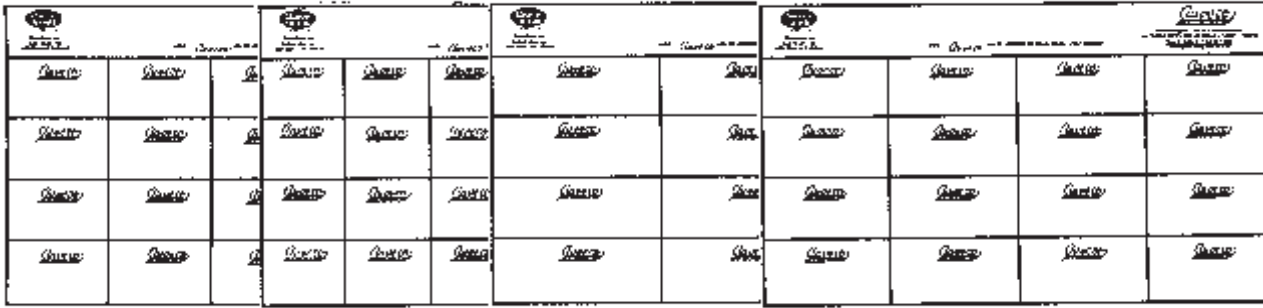

Printed lid labels in 12, 16, 20 and 24 compartment layouts. Same size and layout as current Fix-Kit® lid labels. Available in small and large drawer sizes. These labels have a peel-away liner and self-adhesive backing for permanent adhesion.

**Large Drawer Lid Labels**

**1-900L**  
Assortment of 1 each  
of 1-912L, 1-916L,  
1-920L & 1-924L.  
UNIT PKG: 1 Set

**1-912L**  
Large Drawer  
12 Compartment  
Lid Label  
UNIT PKG: 5

**1-916L**  
Large Drawer  
16 Compartment  
Lid Label  
UNIT PKG: 5

**1-920L**  
Large Drawer  
20 Compartment  
Lid Label  
UNIT PKG: 5

**1-924L**  
Large Drawer  
24 Compartment  
Lid Label  
UNIT PKG: 5

**Small Drawer Lid Labels**

**2-600L**  
Assortment of  
1 each of 2-612L,  
2-616L, 2-620L &  
2-624L  
UNIT PKG: 1 Set

**2-612L**  
Small Drawer  
12 Compartment  
Lid Label  
UNIT PKG: 5

**2-616L**  
Small Drawer  
16 Compartment  
Lid Label  
UNIT PKG: 5

**2-620L**  
Small Drawer  
20 Compartment  
Lid Label  
UNIT PKG: 5

**2-624L**  
Small Drawer  
24 Compartment  
Lid Label  
UNIT PKG: 5

Even though we offer more than 375 assortments, we know you have some great ideas for additional ones. Call our New Product Development Manager or e-mail your new assortment suggestions to [mail@auveco.com](mailto:mail@auveco.com)

# CABINETS AND RACKS

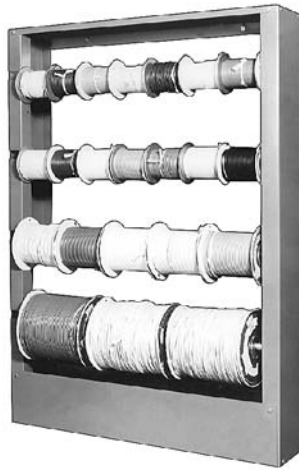

**No. 1-WSR**  
**Wire Spool Rack**  
 26-1/8" Wide x 6" Deep x 37-1/8" High  
 Four sturdy steel rods provide secure and convenient storage for reels as large as 11" in diameter. Heavy duty steel with enamel finish. Does not include wire.  
 Weight: 20 lbs.

**No. 2-WSR**  
**Wire Spool Rack**  
 26" Wide x 5-3/4" Deep x 18" High  
 Two sturdy steel rods for storing and dispensing spools of wire. May be counter, wall or vehicle mounted.  
 Shipping Weight 15 lbs. per carton  
 Can be shipped Via UPS

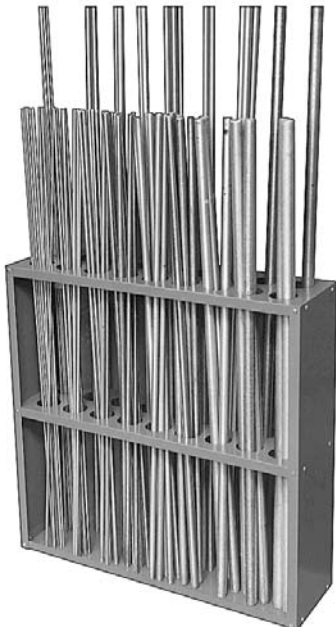

**No. 1-TR**  
**Threaded Rod Rack**  
 24" Wide x 6-7/8" Deep x 24-3/8" High  
 Separates and protects threaded rods, in 18 separate compartments, 2-1/8" (54.0mm) in diameter. Does not include threaded rod stock.  
 Heavy duty steel with enamel finish  
 Weight: 14 lbs.



**No. 1-KS**  
**Key Stock Rack**  
 12-1/4" Wide x 6-1/8" Deep x 12" High  
 Designed to hold material used in the manufacture of keyways which generally run from 1/8" square up to 3/4" square and approximately 12" long. Offers a total of 12 compartments for the convenient storage of stock of 12 different sizes. A 3" panel is furnished for both wall protection or use as a sign. Keyhole slots permit wall mounting. Does not include key stock. Heavy duty steel with enamel finish.  
 Weight: 7 lbs.



**BINS**

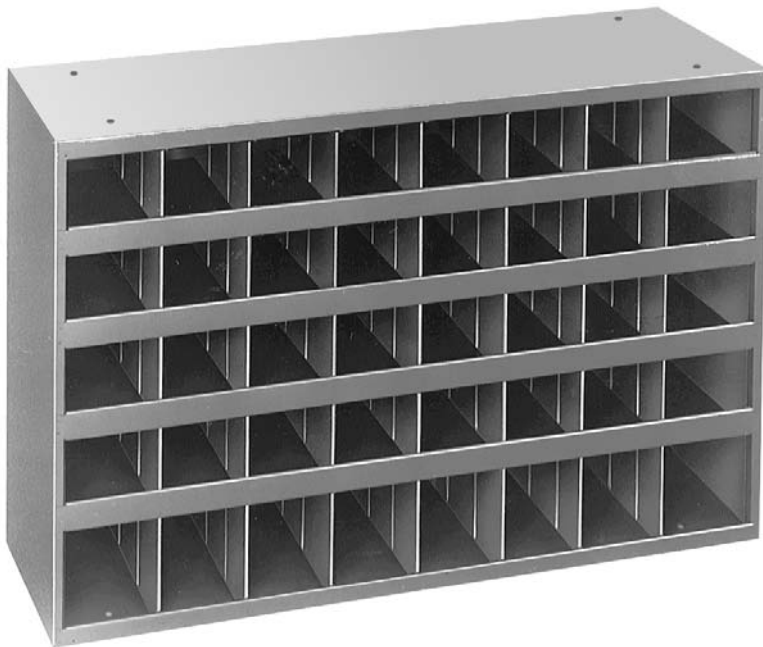

**P277**

**40 Compartment Bin**  
 33-3/4" Wide x 12" Deep x 24" High  
 Shipping Wt. 47 lbs. per carton  
 Packing: 1 Set up unit per carton  
 Color: green or gray enamel finish  
 (illustrated)

Can be shipped via UPS

**P40-S**

**40 Compartment Bin**  
 33-3/4" Wide x 9" Deep x 24" High  
 Shipping Wt. 38 lbs. per carton  
 Packing: 1 set up unit per carton  
 Color: green enamel finish

Can be shipped via UPS

**72B-9**

**72 Compartment Bin**  
 33-3/4" Wide x 9" Deep x 42" High  
 Shipping Weight: 75 lbs.  
 Packing: 1 Set up in two cartons  
 Color: green enamel finish  
 (Sold as a set only)

Can be shipped via UPS

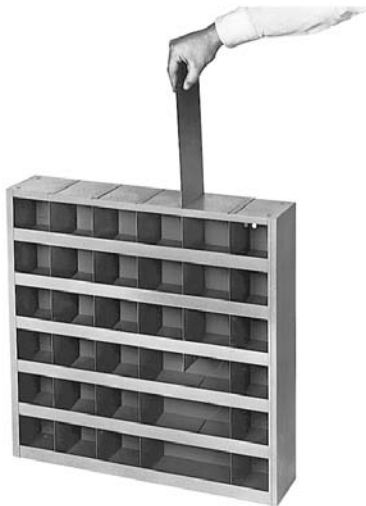

**MB-36**

**Multi-Purpose Bin**  
 23-5/8" Wide x 4-3/4" Deep x 23-5/8" High.  
 Removable vertical dividers allow the creation of double-width openings, each with scoops. Keyhole slots are provided for wall mounting.  
 Shipping Weight: 25 lbs. per carton

Can be shipped via UPS



**18-CB**

**18 Compartment Bin**  
 33-3/4" Wide x 12" Deep x 19-1/4" High  
 Shipping Weight: 38 lbs. Per carton

Can be shipped via UPS



# BIN ACCESSORIES & CABINETS

## Bin Bases



### B-1

Base For Bins P277, P52-C, & 18-D

Raises units 4 or 8 inches off the floor  
Color: green enamel finish

### B-2

Base for Bin P40-S

Raises unit 4 or 8 inches off the floor  
Color: green enamel finish

UNIT PACKAGE: 1



### 18-D

**18 Drawer Cabinet (With 36 Dividers)**

34" Wide x 11-1/4" Deep x 11" High

Shipping Wt. 47 lbs.

Color: standard green enamel finish

Can be shipped via UPS



### Dividers

For 18-D and 9-D

Plastic

2-1/2" x 5-3/16"

UNIT PACKAGE: 1



### 1-ACC

**Aerosol Can Caddy**

21-1/2" Wide x 3-1/8" Deep x 5-1/4" High

Holds 6 cans with a maximum can diameter of 3"

Holes are provided for wall mounting.

Shipping Weight: 2 lbs. per carton

Can be shipped via UPS



### 9-D

**9 Drawer Cabinet (With 18 Dividers)**

17-1/4" Wide x 11-5/8" Deep x 10-7/8" High

Shipping Wt. 28 lbs. per carton

Can be shipped via UPS

**BIN LABELS**



2" x 3/4" Pressure Sensitive Bin Labels Covering Popular Size U.S.S., S.A.E. and Metric Fasteners. 36 Labels Per Each 6-1/4" x 9" Page.

**15531**

U.S.S. Fastener Labels for Cap Screws, Nuts, Lock Washers, Flat Washers and Blanks

Diameters: 1/4", 5/16", 3/8", 7/16", 1/2", 9/16", 5/8", 3/4", 7/8", & 1"  
Lengths: 1/2" thru 6"

Total of 6 pages

UNIT PACKAGE: 1 Set

**15532**

S.A.E. Fastener Labels for Cap Screws, Nuts, Lock Washers, Flat Washers and Blanks

Diameters: 1/4", 5/16", 3/8", 7/16", 1/2", 9/16", 5/8", 3/4", 7/8", & 1"  
Lengths: 1/2" thru 6"

Total of 6 pages

UNIT PACKAGE: 1 Set

**14773**

Miscellaneous Fastener Labels for Carriage Bolts, Nuts, Flat Washers, Stove Bolts, Sheet Metal Screws, Cotter Pins and No. 3 Head Plow Bolts

Total of 6 pages

UNIT PACKAGE: 1 Set

**14774**

Metric Fastener Labels for Hex Cap Screws (Regular & Fine Thread), Hex Nuts, Nylon Insert Lock Nuts, Split Lock Washers, Flat Washers, Wave Washers, Socket Cap Screws and Socket Set Screws

Diameters: 4mm, 5mm, 6mm, 7mm, 8mm, 10mm, 12mm, 14mm, 16mm, 20mm & 24mm.

Total of 9 pages

UNIT PACKAGE: 1 Set

**14775**

Blank Labels  
5 pages of blank labels that can be written on with a ball point pen.

UNIT PACKAGE: 1 Set

**15533**

Bin Labels Assortment  
Consists of 1 set each of 15531, 15532, 14773, 14774 & 14775

UNIT PACKAGE: 1 Set



**BODY SHOP BIN LABELS**

**DB-370L**

Self-adhesive, pre-printed labels for 371 very popular Auveco body shop items. These labels are based on the contents of our DB-370 Plus Display Boards, the 371 items that we recommend everyone stock.

Each label measures 2-13/16" x 1" and contains an Auveco part number, description, O.E.M. number, photograph and unit package quantity. There are 14 pages in one set.

UNIT PACKAGE: 1 Set

# BODY SHOP BIN ASSORTMENTS



Having the right part for the job is a cinch with our assortments for domestic and import vehicle applications. Each assortment contains 36 of the top selling retainers and clips along with a pre-labeled Auveco MB-36 bin.

This 36 compartment bin measures 23-5/8" wide x 4-3/4" deep x 23-5/8" high and can be shipped via UPS. In addition to showing the Auveco part number and bar code, the labels include O.E.M. Numbers as well

## Domestic Vehicle "Xmas Tree" & Push-Type Retainers

**1052** 1 Box each (1115 pieces) of the following parts and a MB-36 bin:



10831	12737	14011	16818
11130	12757	14019	16835
11146	12766	14020	17004
11796	12909	14753	17216
12137	12992	14992	17222
12565	13470	14997	17339
12567	13993	15456	17612
12571	13994	15479	17664
12731	14010	15970	18353

**1053** Same as 1052 except without MB-36 bin.

## Import Vehicle Retaining Clips, Push-Type Retainers & Screw Grommets

**1054** 1 Box each (734 pieces) of the following parts and a MB-36 bin:



14260	14738	17267	18873
14267	14750	17347	18877
14291	16000	17379	19114
14298	16782	17439	19118
14328	16784	17472	19233
14695	16858	17632	19239
14696	17057	18114	19246
14736	17143	18119	19274
14737	17144	18297	19453

**1055** Same as 1054 except without MB-36 bin.

# Sec. 15

## FASTENER CABINET ASSORTMENTS



Auveco offers **one-price package** assortments of popular U.S.S. and metric fasteners. Each assortment contains one box each of 60 different fasteners that are all priced the same. The assortments come in a sturdy, 5 shelf steel cabinet (15-1/2" x 32-1/2" x 4-1/4") that sits on a bench or can be wall mounted.

The assortments are shipped with the product already placed in the cabinet which is labeled with the fastener part numbers for easy re-stocking. Dimensions are clearly printed on the box labels to aid in quick selection of the proper part. All parts are available individually.

### Assortment No. 70000

U.S.S. Coarse Thread Fasteners: Contains one box each of the 60 numbers listed below. Includes cabinet.

Part No.	Size	U.P. Qty.	Part No.	Size	U.P. Qty.	Part No.	Size	U.P. Qty.	Part No.	Size	U.P. Qty.
<b>GRADE 5 U.S.S. CAP SCREWS</b>			<b>GRADE 5 U.S.S. CAP SCREWS (Cont'd.)</b>			<b>U.S.S. HEX NUTS</b>			<b>U.S.S. WASHERS</b>		
70100	1/4-20 x 1/2	27	70117	3/8-16 x 1-1/2	7	70132	1/4-20	42	70147	1/4"	80
70101	1/4-20 x 3/4	23	70118	3/8-16 x 1-3/4	7	70133	5/16-18	34	70148	5/16"	50
70102	1/4-20 x 1	20	70119	3/8-16 x 2	6	70134	3/8-16	26	70149	3/8"	40
70103	1/4-20 x 1-1/4	17	70120	3/8-16 x 2-1/4	6	70135	7/16-14	15	70150	7/16"	20
70104	1/4-20 x 1-1/2	14	70121	3/8-16 x 2-1/2	5	70136	1/2-13	10	70151	1/2"	15
70105	1/4-20 x 2	10	70122	3/8-16 x 3	4	<b>LOCK WASHERS</b>			<b>COTTER PINS</b>		
70106	5/16-18 x 3/4	17	70123	7/16-14 x 1	7	70137	1/4"	100	70152	1/16 x 1	125
70107	5/16-18 x 1	14	70124	7/16-14 x 1-1/4	6	70138	5/16"	85	70153	3/32 x 1	100
70108	5/16-18 x 1-1/4	11	70125	7/16-14 x 1-1/2	5	70139	3/8"	50	70154	3/32 x 1-1/2	80
70109	5/16-18 x 1-1/2	10	70126	7/16-14 x 2	4	70140	7/16"	40	70155	1/8 x 1-1/2	50
70110	5/16-18 x 1-3/4	9	70127	7/16-14 x 2-1/2	4	70141	1/2"	23	70156	1/8 x 2	35
70111	5/16-18 x 2	7	70128	1/2-13 x 1-1/2	4	<b>S.A.E. WASHERS</b>			70157	5/32 x 1-1/2	30
70112	5/16-18 x 2-1/2	6	70129	1/2-13 x 2	3	70142	1/4"	90	70158	5/32 x 2	25
70113	5/16-18 x 3	5	70130	1/2-13 x 2-1/2	3	70143	5/16"	80	70159	3/16 x 2	20
70114	3/8-16 x 3/4	11	70131	1/2-13 x 3	2	70144	3/8"	60			
70115	3/8-16 x 1	10				70145	7/16"	50			
70116	3/8-16 x 1-1/4	9				70146	1/2"	27			

### Assortment No. 71000

Metric Standard Pitch & Fine Pitch Fasteners: Contains one box each of the 60 numbers listed below. Includes cabinet.

Part No.	Size	U.P. Qty.	Part No.	Size	U.P. Qty.	Part No.	Size	U.P. Qty.	Part No.	Size	U.P. Qty.
<b>STANDARD PITCH CAP SCREWS</b>			<b>STANDARD PITCH CAP SCREWS (Cont'd.)</b>			<b>LOCK WASHERS</b>			<b>FINE PITCH CAP SCREWS</b>		
71101	M5-.80 x 12MM	25	71118	M8-1.25 x 45MM	7	71134	5MM	60	71147	M8-1.0 x 35MM	6
71102	M5-.80 x 25MM	20	71119	M8-1.25 x 50MM	7	71135	6MM	45	71148	M8-1.0 x 50MM	5
71103	M6-1.0 x 10MM	20	71120	M8-1.25 x 60MM	6	71136	8MM	25	71149	M10-1.0 x 30MM	4
71104	M6-1.0 x 12MM	20	71121	M8-1.25 x 75MM	5	71137	10MM	20	71150	M10-1.0 x 50MM	3
71105	M6-1.0 x 16MM	18	71122	M10-1.5 x 20MM	6	<b>FLAT WASHERS</b>			71151	M10-1.25 x 20MM	5
71106	M6-1.0 x 20MM	17	71123	M10-1.5 x 25MM	6	71138	5MM	60	71152	M10-1.25 x 25MM	4
71107	M6-1.0 x 25MM	16	71124	M10-1.5 x 30MM	5	71139	6MM	50	71153	M10-1.25 x 30MM	4
71108	M6-1.0 x 30MM	14	71125	M10-1.5 x 35MM	5	71140	8MM	42	71154	M10-1.25 x 35MM	4
71109	M6-1.0 x 40MM	13	71126	M10-1.5 x 40MM	5	71141	10MM	24	71155	M10-1.25 x 40MM	3
71110	M6-1.0 x 45MM	11	71127	M10-1.5 x 50MM	4	<b>COTTER PINS</b>			71156	M10-1.25 x 50MM	3
71111	M8-1.25 x 12MM	12	71128	M10-1.5 x 60MM	4	71142	2MM x 22MM	82	71157	M10-1.25 x 60MM	2
71112	M8-1.25 x 16MM	12	71129	M10-1.5 x 70MM	3	71143	3MM x 25MM	60			
71113	M8-1.25 x 20MM	12	<b>STANDARD PITCH HEX NUTS</b>			71144	5MM x 45MM	20	<b>FINE PITCH HEX NUTS</b>		
71114	M8-1.25 x 25MM	11	71130	M5-.80	41	<b>STUDS</b>			71158	M8-1.00	17
71115	M8-1.25 x 30MM	10	71131	M6-1.0	25	71145	M8-1.25 x 35MM	3	71159	M10-1.00	12
71116	M8-1.25 x 35MM	9	71132	M8-1.25	17	71146	M8-1.25 x 45MM	3	71160	M10-1.25	9
71117	M8-1.25 x 40MM	8	71133	M10-1.5	15						

## FASTENER ASSORTMENTS

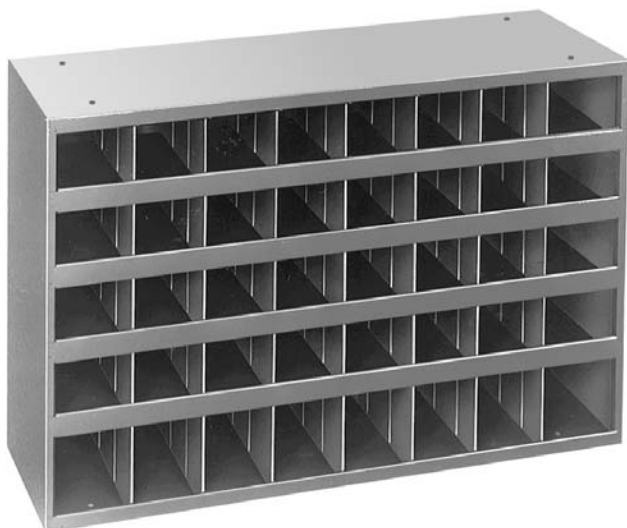

Two assortments of Grade 5 and Grade 8 fasteners. As always all parts are certified to meet or exceed the proper S.A.E. specifications both physically and chemically.

Each assortment includes a pre-labeled Auveco 40 compartment bin P40-S (33-3/4" Wide x 9" Deep x 24" High, can be shipped via UPS). The reorder labels contain the fastener part number, size, description and bar code.

**1020 Grade 5 U.S.S. (Coarse Thread) Fastener Assortment.** Over 2800 pieces of Grade 5 U.S.S. cap screws, hex nuts, high alloy lock washers and high alloy S.A.E. flat washers. Diameters: 1/4"-20, 5/16"-18, 3/8"-16, 7/16"-14 and 1/2"-13. Lengths: 1/2" through 3". All fasteners are zinc plated. Refer to contents listing on next page.

**1021** Same as 1020 except without P40-S bin. Includes planogram and reorder labels.

**1030 Grade 8 U.S.S. (Coarse Thread) Fastener Assortment.** Over 2000 pieces of Grade 8 U.S.S. cap screws, hex nuts, high alloy lock washers and high alloy S.A.E. flat washers. Diameters: 1/4"-20, 5/16"-18, 3/8"-16, 7/16"-14, 1/2"-13 and 5/8"-11. Lengths: 1/2" through 4". All fasteners are zinc plated. Refer to contents listing on next page.

**1031** Same as 1030 except without P40-S bin. Includes planogram and reorder labels.

## Metric Fastener Assortments

**1040 Metric Fastener (Regular Pitch) Assortment.** Over 1200 metric cap screws, hex nuts, lock washers and flat washers with a pre-labeled Auveco 40 compartment bin, P40-S (33-3/4" Wide x 9" Deep x 24" High can be shipped via UPS). The reorder labels contain the fastener part number, size, description and bar code. Diameters: 6mm-1.00, 8mm-1.25, 10mm-1.50 and 12mm-1.75. Lengths: 10mm through 50mm. All fasteners are zinc plated. Refer to contents listing on next page.

**1041** Same as 1040 except without P40-S Bin. Includes planogram and reorder labels.

**1042 Metric Fastener (Regular Pitch & Fine Pitch) Assortment.** Over 1995 metric cap screws, hex nuts, lock washers and flat washers with an Auveco 72B-9 (72 compartment bin). The 72B-9 measures 33-3/4" wide x 9" deep x 42" high and can be shipped via UPS. The bin is pre-labeled showing the Auveco part number, a bar code, size and description. Diameters: M5-.8, M6-1.0, M8-1.25, M8-1.0, M10-1.5, M10-1.25, M10-1.0 & M12-1.75. Lengths: 10mm through 75mm. All fasteners are zinc plated except fine pitch cap screws which have a black finish. Refer to contents listing on following pages.

**1043** Same as 1042 except without 72-9 Bin. Includes planogram and reorder labels.

(Continued on next page)

**FASTENER ASSORTMENT CONTENTS**

**1020 & 1021** Grade 5 U.S.S. (Coarse Thread) Fastener Assortments. Contain 1 Box each of:

5434	1/4"-20 x 1/2" Cap Screw	5480	7/16"-14 x 2" Cap Screw
5436	1/4"-20 x 3/4" Cap Screw	5488	1/2"-13 x 1-1/2" Cap Screw
5438	1/4"-20 x 1" Cap Screw	5490	1/2"-13 x 2" Cap Screw
5439	1/4"-20 x 1-1/4" Cap Screw	5491	1/2"-13 x 2-1/2" Cap Screw
5440	1/4"-20 x 1-1/2" Cap Screw	5492	1/2"-13 x 3" Cap Screw
5442	1/4"-20 x 2" Cap Screw	11925	1/4" High Alloy Lock Washer
5449	5/16"-18 x 3/4" Cap Screw	11926	5/16" High Alloy Lock Washer
5451	5/16"-18 x 1" Cap Screw	11927	3/8" High Alloy Lock Washer
5452	5/16"-18 x 1-1/4" Cap Screw	11928	7/16" High Alloy Lock Washer
5453	5/16"-18 x 1-1/2" Cap Screw	11929	1/2" High Alloy Lock Washer
5455	5/16"-18 x 2" Cap Screw	12781	1/4" High Strength SAE Washer
5463	3/8"-16 x 3/4" Cap Screw	12782	5/16" High Strength SAE Washer
5465	3/8"-16 x 1" Cap Screw	12783	3/8" High Strength SAE Washer
5466	3/8"-16 x 1-1/4" Cap Screw	12784	7/16" High Strength SAE Washer
5467	3/8"-16 x 1-1/2" Cap Screw	12785	1/2" High Strength SAE Washer
5468	3/8"-16 x 1-3/4" Cap Screw	15586	1/4"-20 Grade 5 Hex Nut
5469	3/8"-16 x 2" Cap Screw	15587	5/16"-18 Grade 5 Hex Nut
5471	3/8"-16 x 2-1/2" Cap Screw	15588	3/8"-16 Grade 5 Hex Nut
5476	7/16"-14 x 1" Cap Screw	15589	7/16"-14 Grade 5 Hex Nut
5478	7/16"-14 x 1-1/2" Cap Screw	15590	1/2"-13 Grade 5 Hex Nut

**1030 & 1031** Grade 8 U.S.S. (Coarse Thread) Fastener Assortments. Contain 1 box each of:

9118	1/4"-20 x 1/2" Cap Screw	9164	5/8"-11 x 4" Cap Screw
9119	1/4"-20 x 3/4" Cap Screw	11925	1/4" High Alloy Lock Washer
9120	1/4"-20 x 1" Cap Screw	11926	5/16" High Alloy Lock Washer
9122	1/4"-20 x 1-1/2" Cap Screw	11927	3/8" High Alloy Lock Washer
9128	5/16"-18 x 3/4" Cap Screw	11928	7/16" High Alloy Lock Washer
9129	5/16"-18 x 1" Cap Screw	11929	1/2" High Alloy Lock Washer
9131	5/16"-18 x 1-1/2" Cap Screw	11931	5/8" High Alloy Lock Washer
9137	3/8"-16 x 1" Cap Screw	12781	1/4" High Strength SAE Washer
9138	3/8"-16 x 1-1/4" Cap Screw	12782	5/16" High Strength SAE Washer
9139	3/8"-16 x 1-1/2" Cap Screw	12783	3/8" High Strength SAE Washer
9140	3/8"-16 x 2" Cap Screw	12784	7/16" High Strength SAE Washer
9141	3/8"-16 x 2-1/2" Cap Screw	12785	1/2" High Strength SAE Washer
9146	7/16"-14 x 1-1/2" Cap Screw	12787	5/8" High Strength SAE Washer
9147	7/16"-14 x 2" Cap Screw	15640	1/4"-20 Grade 8 Hex Nut
9153	1/2"-13 x 1-1/2" Cap Screw	15641	5/16"-18 Grade 8 Hex Nut
9155	1/2"-13 x 2" Cap Screw	15642	3/8"-16 Grade 8 Hex Nut
9156	1/2"-13 x 2-1/2" Cap Screw	15643	7/16"-14 Grade 8 Hex Nut
9157	1/2"-13 x 3" Cap Screw	15644	1/2"-13 Grade 8 Hex Nut
9161	5/8"-11 x 2" Cap Screw	15645	5/8"-11 Grade 8 Hex Nut
9163	5/8"-11 x 3" Cap Screw	17499	5/8"-11 x 3-1/2" Cap Screw

**1040 & 1041** Metric Fastener (Regular Pitch) Assortments. Contain 1 box each of:

14584	6mm-1.00 x 10mm Cap Screw (DIN 933)	14434	10mm-1.50 x 40mm Cap Screw (DIN 931)
14407	6mm-1.00 x 12mm Cap Screw (DIN 933)	14435	10mm-1.50 x 45mm Cap Screw (DIN 931)
14408	6mm-1.00 x 16mm Cap Screw (DIN 933)	14436	10mm-1.50 x 50mm Cap Screw (DIN 931)
14409	6mm-1.00 x 20mm Cap Screw (DIN 933)	14440	12mm-1.75 x 25mm Cap Screw (DIN 933)
14410	6mm-1.00 x 25mm Cap Screw (DIN 933)	14441	12mm-1.75 x 30mm Cap Screw (DIN 933)
14411	6mm-1.00 x 30mm Cap Screw (DIN 931)	14442	12mm-1.75 x 35mm Cap Screw (DIN 933)
14412	6mm-1.00 x 35mm Cap Screw (DIN 931)	14443	12mm-1.75 x 40mm Cap Screw (DIN 933)
14413	6mm-1.00 x 40mm Cap Screw (DIN 931)	14445	12mm-1.75 x 50mm Cap Screw (DIN 931)
14419	8mm-1.25 x 16mm Cap Screw (DIN 933)	14450	6mm-1.00 Hex Nut (DIN 934)
14420	8mm-1.25 x 20mm Cap Screw (DIN 933)	14452	8mm-1.25 Hex Nut (DIN 934)
14421	8mm-1.25 x 25mm Cap Screw (DIN 933)	14454	10mm-1.50 Hex Nut (DIN 934)
14422	8mm-1.25 x 30mm Cap Screw (DIN 933)	14455	12mm-1.75 Hex Nut (DIN 934)
14423	8mm-1.25 x 35mm Cap Screw (DIN 931)	10579	6mm Flat Washer (DIN 125)
14424	8mm-1.25 x 40mm Cap Screw (DIN 931)	10581	8mm Flat Washer (DIN 125)
14425	8mm-1.25 x 45mm Cap Screw (DIN 931)	10582	10mm Flat Washer (DIN 125)
14426	8mm-1.25 x 50mm Cap Screw (DIN 931)	10583	12mm Flat Washer (DIN 125)
14430	10mm-1.50 x 20mm Cap Screw (DIN 933)	10586	6mm Lock Washer (DIN 127)
14431	10mm-1.50 x 25mm Cap Screw (DIN 933)	10588	8mm Lock Washer (DIN 127)
14432	10mm-1.50 x 30mm Cap Screw (DIN 933)	10589	10mm Lock Washer (DIN 127)
14433	10mm-1.50 x 35mm Cap Screw (DIN 933)	10590	12mm Lock Washer (DIN 127)

**FASTENER ASSORTMENT CONTENTS**

**1042 & 1043** Metric Fastener (Regular Pitch & Fine Pitch) Assortments. Contain one box each of:

<b>14583</b> 5mm-.8 x 12mm Cap Screw	(DIN 933)	<b>14441</b> 12mm-1.75 x 30mm Cap Screw	(DIN 933)
<b>14403</b> 5mm-.8 x 16mm Cap Screw	(DIN 933)	<b>14442</b> 12mm-1.75 x 35mm Cap Screw	(DIN 933)
<b>14404</b> 5mm-.8 x 20mm Cap Screw	(DIN 933)	<b>14443</b> 12mm-1.75 x 40mm Cap Screw	(DIN 933)
<b>14405</b> 5mm-.8 x 25mm Cap Screw	(DIN 933)	<b>14445</b> 12mm-1.75 x 50mm Cap Screw	(DIN 931)
<b>14406</b> 5mm-.8 x 30mm Cap Screw	(DIN 933)	<b>14446</b> 12mm-1.75 x 60mm Cap Screw	(DIN 931)
<b>15512</b> 5mm-.8 x 40mm Cap Screw	(DIN 933)	<b>14447</b> 12mm-1.75 x 70mm Cap Screw	(DIN 931)
<b>14584</b> 6mm-1.0 x 10mm Cap Screw	(DIN 933)	<b>14449</b> 5mm-.8 Hex Nut	(DIN 934)
<b>14407</b> 6mm-1.0 x 12mm Cap Screw	(DIN 933)	<b>14450</b> 6mm-1.0 Hex Nut	(DIN 934)
<b>14408</b> 6mm-1.0 x 16mm Cap Screw	(DIN 933)	<b>14452</b> 8mm-1.25 Hex Nut	(DIN 934)
<b>14409</b> 6mm-1.0 x 20mm Cap Screw	(DIN 933)	<b>14454</b> 10mm-1.5 Hex Nut	(DIN 934)
<b>14410</b> 6mm-1.0 x 25mm Cap Screw	(DIN 933)	<b>14455</b> 12mm-1.75 Hex Nut	(DIN 934)
<b>14411</b> 6mm-1.0 x 30mm Cap Screw	(DIN 931)	<b>10578</b> 5mm Flat Washer	(DIN 125)
<b>14412</b> 6mm-1.0 x 35mm Cap Screw	(DIN 931)	<b>10579</b> 6mm Flat Washer	(DIN 125)
<b>14413</b> 6mm-1.0 x 40mm Cap Screw	(DIN 931)	<b>10581</b> 8mm Flat Washer	(DIN 125)
<b>14585</b> 6mm-1.0 x 50mm Cap Screw	(DIN 931)	<b>10582</b> 10mm Flat Washer	(DIN 125)
<b>14588</b> 8mm-1.25 x 12mm Cap Screw	(DIN 933)	<b>10583</b> 12mm Flat Washer	(DIN 125)
<b>14419</b> 8mm-1.25 x 16mm Cap Screw	(DIN 933)	<b>10585</b> 5mm Lock Washer	(DIN 127)
<b>14420</b> 8mm-1.25 x 20mm Cap Screw	(DIN 933)	<b>10586</b> 6mm Lock Washer	(DIN 127)
<b>14421</b> 8mm-1.25 x 25mm Cap Screw	(DIN 933)	<b>10588</b> 8mm Lock Washer	(DIN 127)
<b>14422</b> 8mm-1.25 x 30mm Cap Screw	(DIN 933)	<b>10589</b> 10mm Lock Washer	(DIN 127)
<b>14423</b> 8mm-1.25 x 35mm Cap Screw	(DIN 931)	<b>10590</b> 12mm Lock Washer	(DIN 127)
<b>14424</b> 8mm-1.25 x 40mm Cap Screw	(DIN 931)	<b>11258</b> 8mm-1.0 x 35mm Fine Cap Screw	(DIN 961)
<b>14425</b> 8mm-1.25 x 45mm Cap Screw	(DIN 931)	<b>14604</b> 8mm-1.0 x 50mm Fine Cap Screw	(DIN 960)
<b>14426</b> 8mm-1.25 x 50mm Cap Screw	(DIN 931)	<b>14605</b> 10mm-1.25 x 20mm Fine Cap Screw	(DIN 961)
<b>14428</b> 8mm-1.25 x 60mm Cap Screw	(DIN 931)	<b>11265</b> 10mm-1.25 x 25mm Fine Cap Screw	(DIN 961)
<b>14429</b> 8mm-1.25 x 70mm Cap Screw	(DIN 933)	<b>11266</b> 10mm-1.25 x 30mm Fine Cap Screw	(DIN 961)
<b>14589</b> 8mm-1.25 x 75mm Cap Screw	(DIN 931)	<b>11267</b> 10mm-1.25 x 35mm Fine Cap Screw	(DIN 961)
<b>14430</b> 10mm-1.5 x 20mm Cap Screw	(DIN 933)	<b>11268</b> 10mm-1.25 x 40mm Fine Cap Screw	(DIN 961)
<b>14431</b> 10mm-1.5 x 25mm Cap Screw	(DIN 933)	<b>11269</b> 10mm-1.25 x 50mm Fine Cap Screw	(DIN 961)
<b>14432</b> 10mm-1.5 x 30mm Cap Screw	(DIN 933)	<b>14606</b> 10mm-1.25 x 60mm Fine Cap Screw	(DIN 961)
<b>14433</b> 10mm-1.5 x 35mm Cap Screw	(DIN 933)	<b>11262</b> 10mm-1.0 x 30mm Fine Cap Screw	(DIN 961)
<b>14434</b> 10mm-1.5 x 40mm Cap Screw	(DIN 931)	<b>11264</b> 10mm-1.0 x 50mm Fine Cap Screw	(DIN 961)
<b>14435</b> 10mm-1.5 x 45mm Cap Screw	(DIN 931)	<b>14453</b> 8mm-1.0 Fine Pitch Hex Nut	(DIN 934)
<b>14436</b> 10mm-1.5 x 50mm Cap Screw	(DIN 931)	<b>14457</b> 10mm-1.25 Fine Pitch Hex Nut	(DIN 934)
<b>14438</b> 10mm-1.5 x 60mm Cap Screw	(DIN 931)	<b>14456</b> 10mm-1.0 Fine Pitch Hex Nut	(DIN 934)
<b>14439</b> 10mm-1.5 x 70mm Cap Screw	(DIN 931)		
<b>14440</b> 12mm-1.75 x 25mm Cap Screw	(DIN 933)		

# Sec. 15

# "6000" SERIES SMALL DRAWER "FIX-KITS"



Auveco offers more than 60 prepackaged "FIX-KITS"® in the "6000" series small drawer. Each drawer measures 13-5/16" wide x 9-1/4" deep x 2" high.

Printed lid labels identify the correct Auveco part number for ordering refills.

## "6000 Series Small Drawer "Fix-Kit"® Numeric Listing

Auveco Part No.	Description	Auveco Part No.	Description
6001	Slotted Pan Head Tapping Screws	6124	Spring Pins
6003	Phillips Oval Head Tapping Screws	6125	Spring Pins
6004	Special Tapping Screws	6128	Grease Fittings
6007	Tubular, Flat, "U" & "J" Nuts	6133	Insulated Closed Clamps
6011	Round Head Machine Screws & Nuts	6139	Clevis Pins
6025	Hex Washer Head Tapping Screws	6144	Teks® Tapping Screws
6036	Phillips Oval Head Tapping Screws	6148	Tubular Nuts
6037	Phillips Oval Head Tapping Screws	6156	Phillips Black Oxide Tapping Screws
6038	Phillips Pan Head Tapping Screws	6158	Metric Cotter Pins
6043	Thread Cutting & Washer Lock Nuts	6160	Metric Cap Screws & Nuts
6049	Phillips Oval Head Sems® Tapping Screws	6161	Metric Cap Screws & Nuts
6051	Cotter Pins	6162	"Xmas Tree" Retainers
6059	Solderless Terminals	6164	Pushnut Bolt Retainers
6060	Universal Clevis Pins	6166	Body & Fender Shims
6062	Plug Buttons	6167	Tee Connectors
6065	Woodruff Keys	6168	Hose Connectors
6067	Expansion Plugs	6169	Headlight Adjusting Screw Assemblies
6070	Internal & External Lock Washers	6171	Stainless Steel Torx® Screws
6073	Socket Head Set Screws	6172	Push-On Retainers & Bolt Retainers
6085	"O" Rings	6173	Solderless Terminals
6086	Throttle Rod Clips & E-Clips	6174	Solderless Terminals
6106	Oil Drain Plugs & Gaskets	6175	Solderless Terminals
6110	Cotter Pins	6176	Thread Repair Inserts
6112	Cotter Pins	6178	O.E.M. Electrical Terminals
6113	Cotter Pins	6182	Phillips Washer Head Tapping Screws
6116	Internal & External Retaining Rings	6184	Stainless Steel Screws, Nuts & Washers
6117	"O" Rings	6185	Stainless Steel Tapping Screws
6119	Brass Compression Fittings	6186	Oil Drain Plugs & Gaskets
6121	Brass Pipe Fittings	6187	Metric Grease Fittings
6123	"E" Rings	6188	J.I.S. Cap Screws & Nuts

## "6000" Series/"6500" Series Kit Cross Reference

"6000" Kit	"6500" Kit	"6000" Kit	"6500" Kit	"6000" Kit	"6500" Kit
6001	6500	6116	6507	6178	6526
6003	6501	6123	6508	6182	6530
6007	6502	6124	6509	6184	6532
6011	6503	6125	6510	6185	6533
6065	6504	6128	6511	6186	6534
6085	6505	6160	6513	6144	6536
6112	6506	6161	6514		

The New 6600 Series Body Hardware Master Assortments are listed on pages 265 - 267.



**“6000” SERIES SMALL DRAWER “FIX-KITS”®**

**Sec. 15**



**No. 6036 “Fix-Kit”**  
Phillips Oval Head Tapping Screws  
Chrome Plated  
20 Varieties - 1105 Pieces

Auveco Part No.	Size	Head
3067	4 x 3/8"	No.4
3068	4 x 1/2"	
5604	4 x 5/8"	
3069	4 x 3/4"	
3070	4 x 1"	
2802	6 x 3/8"	
2698	6 x 1/2"	
1793	6 x 5/8"	
1794	6 x 3/4"	
1796	6 x 1"	
1797	6 x 1-1/4"	
3485	8 x 3/8"	
2707	8 x 1/2"	
2709	8 x 5/8"	
2710	8 x 3/4"	
2712	8 x 7/8"	
2713	8 x 1"	
2715	8 x 1-1/8"	
2716	8 x 1-1/4"	
2718	8 x 1-1/2"	



**No. 6003 “Fix-Kit”**  
Phillips Oval Head Tapping Screws  
Zinc & Chrome Plated  
24 Varieties - 540 Pieces

Auveco Part No.	Size	Head
3069	4 x 3/4"	No.6
1793	6 x 5/8"	
1794	6 x 3/4"	
1796	6 x 1"	
1797	6 x 1-1/4"	
2024	8 x 3/8"	
2358	8 x 1/2"	
2027	8 x 1/2"	
1421	8 x 5/8"	
1799	8 x 3/4"	
2359	8 x 3/4"	
1801	8 x 1"	
1802	8 x 1-1/8"	
2361	8 x 1-1/4"	
1803	8 x 1-1/4"	
2362	8 x 1-1/2"	
1932	8 x 1-1/2"	
1933	8 x 1-3/4"	
1717	10 x 3/4"	
2728	10 x 3/4"	
1804	10 x 1"	
1807	10 x 1-1/8"	
2046	10 x 1-1/2"	
2047	10 x 1-3/4"	



**No. 6001 “Fix-Kit”**  
Slotted Pan Head Tapping Screws  
Zinc Plated  
24 Varieties - 1050 Pieces

Auveco Part No.	Size
1728	6 x 1/4"
1263	6 x 3/8"
1452	6 x 1/2"
1453	6 x 5/8"
1454	6 x 3/4"
1455	6 x 1"
1456	8 x 3/8"
1146	8 x 1/2"
1092	8 x 5/8"
1147	8 x 3/4"
1457	8 x 1"
1730	10 x 3/8"
1458	10 x 1/2"
1787	10 x 5/8"
1265	10 x 3/4"
1459	10 x 1"
1460	10 x 1-1/2"
1266	10 x 1-3/4"
1343	12 x 1/2"
1344	12 x 3/4"
1346	12 x 1"
1347	14 x 1/2"
1381	14 x 3/4"
1382	14 x 1"



**No. 6156 “Fix-Kit”**  
Black Oxide Screws  
Phillips Oval -Pan -Flat Heads  
12 Varieties - 830 Pieces

Auveco Part No.	Size	Type Head
10180	8 x 1/2"	Pan
10173	8 x 1/2", 6 Hd.	Flat
10181	8 x 3/4"	Pan
10174	8 x 3/4", 6 Hd.	Flat
10164	8 x 3/4", 6 Hd.	Oval
10165	8 x 3/4"	Oval
10182	8 x 1"	Pan
10176	8 x 1", 6 Hd.	Flat
10166	8 x 1", 6 Hd.	Oval
10178	8 x 1-1/4", 6 Hd.	Flat
10179	8 x 1-1/4"	Flat
10168	8 x 1-1/4", 6 Hd.	Oval



**No. 6037 “Fix-Kit”**  
Phillips Oval Head Tapping Screws  
Zinc & Chrome Plated  
24 Varieties - 895 Pieces

Auveco Part No.	Size	Head
2802	6 x 3/8"	No. 4
2024	8 x 3/8"	No. 6
2027	8 x 1/2"	No. 6
1421	8 x 5/8"	No. 6
1799	8 x 3/4"	No. 6
2711	8 x 7/8"	No. 6
1483	8 x 1"	No. 6
1802	8 x 1-1/8"	No. 6
1423	8 x 1-1/4"	No. 6
1932	8 x 1-1/2"	No. 6
1933	8 x 1-3/4"	No. 6
2632	8 x 2"	No. 6
2656	10 x 1/2"	No. 6
2657	10 x 1/2"	No. 8
2658	10 x 5/8"	No. 6
2724	10 x 5/8"	No. 8
2659	10 x 3/4"	No. 6
1717	10 x 3/4"	No. 8
1804	10 x 1"	No. 6
2730	10 x 1"	No. 8
2733	10 x 1-1/4"	No. 6
2734	10 x 1-1/4"	No. 8
2046	10 x 1-1/2"	No. 6
2047	10 x 1-3/4"	No. 6



**No. 6038 “Fix-Kit”**  
Phillips Pan Head Tapping Screws  
Zinc Plated  
20 Varieties - 1385 Pieces

Auveco Part No.	Size
3071	4 x 1/4"
3072	4 x 3/8"
3073	4 x 1/2"
3074	4 x 3/4"
3075	4 x 1"
1935	6 x 1/4"
1936	6 x 3/8"
1937	6 x 1/2"
2364	6 x 3/4"
3076	6 x 1"
3077	6 x 1-1/4"
3078	6 x 1-1/2"
1939	8 x 3/8"
1940	8 x 1/2"
5625	8 x 5/8"
2365	8 x 3/4"
3079	8 x 1"
3080	8 x 1-1/4"
3081	8 x 1-1/2"
2088	8 x 1-3/4"

**Sec. 15**

**"6000" SERIES SMALL DRAWER "FIX-KITS"**



**No. 6004 "Fix-Kit"**

Phillips Specialty Tapping Screws  
Zinc Plated  
24 Varieties - 795 Pieces

Auveco Part No.	Size	Head
1936	6 x 3/8"	
1937	6 x 1/2"	
2364	6 x 3/4"	
1939	8 x 3/8"	
10642	8 x 3/8"	
2805	8 x 7/16"	
1940	8 x 1/2"	
12095	8 x 1/2"	
14859	8 x 1/2"	
15171	8 x 1/2"	
15172	8 x 1/2"	
1712	8 x 3/4"	No. 6
2365	8 x 3/4"	
3079	8 x 1"	
2178	10 x 3/8"	
1943	10 x 1/2"	
2808	10 x 5/8"	
13709	10 x 3/4"	
2366	10 x 3/4"	
3082	10 x 1"	
2367	12 x 3/4"	
3086	12 x 1"	
3089	14 x 1/2"	
3090	14 x 3/4"	



**No. 6185 "Fix-Kit"**

Stainless Steel Phillips Head  
Tapping Screws  
24 Varieties - 1600 Pieces

Auveco Part No.	Size	Head
9399	#6 x 1/2"	Oval
9400	#6 x 3/4"	Oval
9401	#6 x 1"	Oval
9403	#8 x 1/2"	Oval
9404	#8 x 3/4"	Oval
9405	#8 x 1"	Oval
9406	#8 x 1-1/4"	Oval
9407	#8 x 1-1/2"	Oval
9409	#10 x 3/4"	Oval
9410	#10 x 1"	Oval
9412	#10 x 1-1/2"	Oval
13265	#6 x 1/2"	Pan
13266	#6 x 3/4"	Pan
13267	#6 x 1"	Pan
13269	#8 x 1/2"	Pan
13270	#8 x 3/4"	Pan
13271	#8 x 1"	Pan
13272	#8 x 1-1/4"	Pan
13273	#8 x 1-1/2"	Pan
13274	#10 x 1/2"	Pan
13275	#10 x 3/4"	Pan
13276	#10 x 1"	Pan
13277	#10 x 1-1/4"	Pan
13278	#10 x 1-1/2"	Pan



**No. 6049 "Fix-Kit"**

Phillips Oval Head Sems®  
Tapping Screws  
Chrome Plated  
12 Varieties - 460 Pieces

Auveco Part No.	Size	Head
3537	6 x 5/8"	
3538	6 x 3/4"	
3539	6 x 1"	
2771	8 x 5/8"	
2751	8 x 3/4"	
2772	8 x 1"	
2773	8 x 1-1/4"	
14970	8 x 1-1/2"	No. 6
3465	10 x 5/8"	No. 8
3466	10 x 3/4"	No. 8
3467	10 x 1"	No. 8
3468	10 x 1-1/4"	No. 8



**No. 6171 "Fit-Kit"**

Oval Head And Pan Head Metric  
Torx® Tapping Screws  
10 varieties - 250 Pieces

Auveco Part No.	Size	Head
11937*	M4.2 x 20mm	Chrome
11938*	M4.2 x 20mm	Black Ox
11943•	M4.2 x 20mm	Chrome
11944•	M4.2 x 20mm	Black Ox
14046•	M4.2 x 25mm	Black Ox
11939*	M4.2 x 30mm	Chrome
11940*	M4.2 x 30mm	Black Ox
14050•	M4.2 x 30mm	Black Ox
11945•	M4.2 x 35mm	Chrome
11941*	M4.2 x 40mm	Chrome

\* 7mm Oval Head  
• 8mm Pan Head

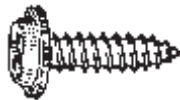

**No. 6182 "Fix-Kit"**

Phillips Flat Top Washer Head  
Tapping Screws  
Black "E" Coat Plated  
12 Varieties - 1790 Pieces

Auveco Part No.	Size	Head
12950	#6 x 1/2"	Black E Coat
12951	#6 x 3/4"	Black E Coat
12213	#8 x 1/2"	Black E Coat
12214	#8 x 5/8"	Black E Coat
12215	#8 x 3/4"	Black E Coat
12216	#8 x 1"	Black E Coat
12217	#8 x 1-1/4"	Black E Coat
12218	#8 x 1-1/2"	Black E Coat
12953	#10 x 3/4"	Black E Coat
12954	#10 x 1"	Black E Coat
14859	#8 x 1/2"	Zinc
14861	#8 x 3/4"	Zinc



**No. 6144 "Fix-Kit"**

Teks® Self-Drilling Screws  
Pozi-Driv Pan Head  
Hex Washer Head  
Zinc Plated  
16 Sizes - 365 Pieces

Auveco Part No.	Size	Head
9605	8 x 1/2"	Pan
9606	8 x 3/4"	Pan
9607	10 x 1/2"	Pan
9608	10 x 3/4"	Pan
11905	12 x 1"	Pan
9611	8 x 1/2"	Hex
9612	8 x 3/4"	Hex
9613	10 x 1/2"	Hex
9614	10 x 5/8"	Hex
9615	10 x 3/4"	Hex
9616	10 x 1"	Hex
11911	12 x 1"	Hex
9620	14 x 3/4"	Hex
11914	14 x 1"	Hex
11915	14 x 1-1/4"	Hex
11916	14 x 1-1/2"	Hex



**No. 6025 “Fix-Kit”**  
 Slotted Hex Washer Head  
 Tapping Screws  
 5/16" Hex  
 Zinc Plated  
 13 Varieties - 925 Pieces

Auveco Part No.	Size
3380	10 x 3/8"
3381	10 x 1/2"
3382	10 x 5/8"
3383	10 x 3/4"
3385	10 x 1"
3386	10 x 1-1/4"
3387	10 x 1-1/2"
3388	12 x 1/2"
3389	12 x 5/8"
3390	12 x 3/4"
3392	12 x 1"
3393	12 x 1-1/4"
3394	12 x 1-1/2"



**No. 6011 “Fix-Kit”**  
 Slotted Round Head  
 Machine Screws  
 Zinc Plated  
 19 Varieties of Screws  
 5 Varieties of Nuts  
 1110 Pieces

Auveco Part No.	Size
727	6-32 Nut
728	8-32 Nut
729	10-32 Nut
730	10-24 Nut
731	12-24 Nut
2530	6-32 x 1/2"
2531	6-32 x 3/4"
2532	6-32 x 1"
2533	8-32 x 1/2"
2534	8-32 x 3/4"
2535	8-32 x 1"
2536	10-32 x 1/2"
2537	10-32 x 3/4"
2538	10-32 x 1"
2539	10-32 x 1-1/4"
2540	10-32 x 1-1/2"
2541	10-24 x 1/2"
2542	10-24 x 3/4"
2543	10-24 x 1"
2544	10-24 x 1-1/4"
2545	10-24 x 1-1/2"
2546	12-24 x 1/2"
2548	12-24 x 1"
2550	12-24 x 1-1/2"

**Do You Have An Idea  
 For A New Assortment?  
 E-mail Your Suggestion  
 To [mail@auveco.com](mailto:mail@auveco.com)**

**Auveco Display Boards  
 And Flip Chart (With  
 Actual Size Illustrations)  
 Feature Over 1,000  
 Items.**

**Refer To The Color  
 Pages At The Front Of  
 The Catalog For  
 More Details.**

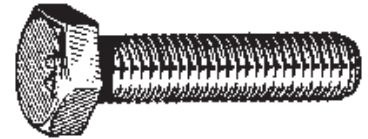

**No. 6160 “Fix-Kit”**  
 Metric Regular Pitch  
 Cap Screws & Nuts  
 DIN 933  
 Zinc Plated  
 16 Varieties - 236 Pieces

Auveco Part No.	Size
14400	M4-.7 x 16mm
14401	M4-.7 x 20mm
14402	M5-.8 x 10mm
14403	M5-.8 x 16mm
14404	M5-.8 x 20mm
14405	M5-.8 x 25mm
14408	M6-1.0 x 16mm
14409	M6-1.0 x 20mm
14410	M6-.10 x 25mm
14420	M8-1.25 x 20mm
14421	M8-1.25 x 25mm
14422	M8-1.25 x 30mm
14448	M4-.7 Nut
14449	M5-.8 Nut
14450	M6-1.0 Nut
14452	M8-1.25 Nut



**No. 6161 “Fix-Kit”**  
 Metric Regular Pitch  
 Cap Screws & Nuts  
 DIN 933  
 Zinc Plated  
 15 Varieties - 128 Pieces

Auveco Part No.	Size
14424	M8-1.25 x 40mm
14425	M8-1.25 x 45mm
14426	M8-1.25 x 50mm
14431	M10-1.50 x 25mm
14432	M10-1.50 x 30mm
14433	M10-1.50 x 35mm
14434	M10-1.50 x 40mm
14436	M10-1.50 x 50mm
14440	M12-1.75 x 25mm
14441	M12-1.75 x 30mm
14442	M12-1.75 x 35mm
14443	M12-1.75 x 40mm
14452	M8-1.25 Nut
14454	M10-1.50 Nut
14455	M12-1.75 Nut

**Sec. 15**

**"6000" SERIES SMALL DRAWER "FIX-KITS"**

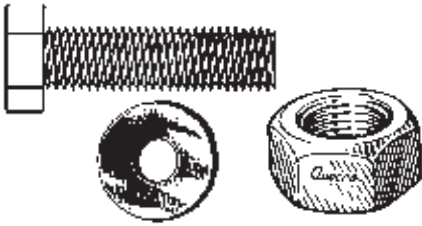

**No. 6184 "Fix-Kit"**

Stainless Steel  
Cap Screws, Nuts & Washers  
24 Varieties - 660 Pieces

Auveco Part No.	Size
13346	1/4"-20 x 1/2"
13347	1/4"-20 x 3/4"
13348	1/4"-20 x 1"
13349	1/4"-20 x 1-1/4"
13350	1/4"-20 x 1-1/2"
13352	1/4"-20 x 2"
13354	5/16"-18 x 3/4"
13355	5/16"-18 x 1"
13356	5/16"-18 x 1-1/4"
13357	5/16"-18 x 1-1/2"
13359	5/16"-18 x 2"
13364	3/8"-16 x 1"
13365	3/8"-16 x 1-1/4"
13366	3/8"-16 x 1-1/2"
13368	3/8"-16 x 2"
13234	1/4"-20 Hex Nut
13235	5/16"-18 Hex Nut
13236	3/8"-16 Hex Nut
13395	1/4" Flat Wshr
13396	5/16" Flat Wshr
13397	3/8" Flat Wshr
13403	1/4" Lock Wshr
13404	5/16" Lock Wshr
13405	3/8" Lock Wshr



**No. 6188 "Fix-Kit"**

J.I.S. Cap Screws & Nuts  
16 Varieties - 335 Pieces

Auveco Part No.	Size
14777	8mm-1.25 x 16mm
14778	8mm-1.25 x 20mm
14779	8mm-1.25 x 25mm
14780	8mm-1.25 x 30mm
14781	8mm-1.25 x 35mm
14782	8mm-1.25 x 40mm
14787	10mm-1.25 x 20mm
14788	10mm-1.25 x 25mm
14789	10mm-1.25 x 30mm
14790	10mm-1.25 x 35mm
14791	10mm-1.25 x 40mm
14792	10mm-1.25 x 45mm
14793	10mm-1.25 x 50mm
14794	10mm-1.25 x 60mm
14796	8mm-1.25 Hex Nuts
14797	10mm-1.25 Hex Nuts



**No. 6073 "Fix-Kit"**

Socket Head Set Screws  
47 Varieties Screws  
540 Pieces

Auveco Part No.	Size
5366	6-32 x 1/4"
5367	6-32 x 5/16"
5368	6-32 x 3/8"
5370	8-32 x 1/4"
5371	8-32 x 5/16"
5372	8-32 x 3/8"
5373	8-32 x 1/2"

Auveco Part No.		Size
USS	SAE	
5374	5394	10 x 3/16"
5375	5395	10 x 1/4"
5376	5396	10 x 5/16"
5377	5397	10 x 3/8"
5378	5398	10 x 1/2"
5379	5399	1/4 x 1/4"
5380	5400	1/4 x 5/16"
5381	5401	1/4 x 3/8"
5382	5402	1/4 x 7/16"
5383	5403	1/4 x 1/2"
5384	5404	5/16 x 1/4"
5385	5405	5/16 x 5/16"
5386	5406	5/16 x 3/8"
5387	5407	5/16 x 7/16"
5388	5408	5/16 x 1/2"
5389	5409	3/8 x 5/16"
5390	5410	3/8 x 3/8"
5391	5411	3/8 x 7/16"
5392	5412	3/8 x 1/2"
5393	5413	3/8 x 5/8"



**No. 6148 "Fix-Kit"**

Tubular Nuts  
16 Varieties - 800 Pieces

Auveco Part No.	Size
2565	3/16" Stud
2595	1/8" Stud
2611	1/8" Stud
3136	1/16" Stud
3137	3/32" Stud
3776	3/32" Stud
3777	1/8" Stud
5195	1/8" Stud
5196	1/4" Stud
8545	5/32" Stud
8546	5/32" Stud
8572	#10 Screw
10072	3/16" Stud
10073	3/16" Stud
11293	1/8" Stud
19537	1/4" Stud



**No. 6007 "Fix-Kit"**

Tubular, Flat, "U" & "J" Nuts  
24 Varieties - 515 Pieces

Auveco Part No.	Size
1903	1/4"-20 Flat
2089	#6-32 Flat
2092	#10-24 Flat
2099	1/8" Stud Flat
2103	3/16" Stud Flat
2105	1/4" Stud Flat
2293	1/4"-20 "U"
2346	#8 "J"
2422	#10 "U"
2595	1/8" Stud Tubular
2611	1/8" Stud Tubular
5170	3/8"-16 "J"
5197	#10-24 "U"
5586	1/4"-20 "J" Cage
5589	5/16"-18 "J" Cage
9879	#8 Spring "U"
9880	#8 Spring "U"
10064	#6 Spring "U"
10065	#8 Spring "U"
10066	#10 Spring "U"
10067	#14 Spring "U"
10666	#8 "U"
11292	#8 "U"
11429	#10 "U"



**No. 6106 “Fix-Kit”**  
Oversize Self Tapping  
Oil Drain Plugs  
Zinc Plated  
With Fibre Gaskets  
7 Varieties - 35 Pieces

Auveco Part No.	Size	
17145	1/2-20	Single Oversize
18121	1/2-20	Double Oversize
18122	1/2-20	Triple Oversize
8285	5/8-18	Oversize
8286	11/16-20	Oversize
8288	3/4-16	Oversize
8289	7/8-18	Oversize



**No. 6070 “Fix-Kit”**  
Shakeproof Lock Washers  
(External - Internal Countersunk)  
Zinc Plated  
24 Varieties - 1450 Pieces

Auveco Part No.	Size	Type
5249	4	External
5259	4	Internal
5250	6	External
5260	6	Internal
5270	6	Countersunk
5251	8	External
5261	8	Internal
5271	8	Countersunk
5252	10	External
5262	10	Internal
5272	10	Countersunk
5253	12	External
5263	12	Internal
5254	1/4"	External
5264	1/4"	Internal
5255	5/16"	External
5265	5/16"	Internal
5256	3/8"	External
5266	3/8"	Internal
5257	7/16"	External
5267	7/16"	Internal
5258	1/2"	External
5268	1/2"	Internal
5274	1/4"	Countersunk

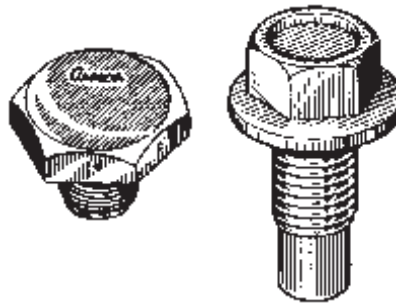

**No. 6186 “Fix-Kit”**  
Oil Drain Plugs & Gaskets  
12 Varieties - 104 Pieces

Auveco Part No.	Size
14196	1/2"-20
11782	1/2"-20 Oversize “Piggy-Back”
18121	1/2"-20 Double Oversize
18122	1/2"-20 Triple Oversize
8285	5/8"-18 Oversize
15527	M12-1.25 x 11mm
14677	M12-1.25 x 26mm
16308	M14-1.5
14678	M14-1.5
15528	M16.4 Oversize
15529	M18-1.5
15530	M20-1.5



**No. 6043 “Fix-Kit”**  
Washer Lock Nuts  
& Thread Cutting Nuts  
16 Varieties - 1545 Pieces

Auveco Part No.	Size
2554	#6-32
2555	#8-32
2556	#10-32
2557	#10-24
2560	#12-24
2561	1/4"-20
2562	1/4"-20
2895	1/8" Stud
2896	3/16" Stud
2897	1/4" Stud
3400	1/8" Stud
3401	1/8" Stud
3402	3/16" Stud
3403	1/8" Stud
3404	3/16" Stud
3405	1/4" Stud

Even Though We Offer  
Over 375 Assortments,  
We Know You Have  
Some Great Ideas For  
Additional Ones.  
Call Our New Product  
Development Manger or  
e-mail Your New Assortment  
Suggestions To  
mail@auveco.com



**No. 6164 “Fix-Kit”**  
Push Nut Bolt Retainer  
6 Sizes - 1050 Pieces

Auveco Part No.	For Bolt Diameter
10086	1/4"
10085	5/32"
10087	5/16"
9297	3/8"
9298	7/16"
9299	1/2"



**No. 6172 “Fix-Kit”**  
Metric Pushnut Bolt Retainers &  
Push-on Fasteners  
10 Sizes - 745 Pieces

Auveco Part No.	Bolt or Stud Size
12119	4.0mm Stud
12122	M5-.8
12123	M6-1.0
14980	M6-1.0
12124	M6.3-1.0
12125	M8-1.25
12259	M8-1.25
12126	M10-1.50
12260	M10-1.50
12127	M12-1.75

**Sec. 15**

**"6000" SERIES SMALL DRAWER "FIX-KITS"**



**No. 6086 "Fix-Kit"**

Rod End Clips  
And "E" Clips  
16 Varieties - 560 Pieces

Auveco Part No.      Shaft Diameter

**Rod End Clips**

3609	5/32"	Right Side
3610	5/32"	Left Side
3611	3/16"	Right Side
3612	3/16"	Left Side
3613	1/4"	Right Side
3614	1/4"	Left Side

**"E" Clips**

3165	1/8"	
3166	3/16"	
3167	1/4"	
3824	5/16"	Small O.D.
3628	5/16"	Large O.D.
5600	3/8"	
2672	7/16"	
5602	1/2"	
5601	9/16"	
5603	5/8"	



**No. 6123 "Fix-Kit"**

"E" & Reinforced "E" Rings  
Groove Required  
24 Varieties - 1500 Pieces

Auveco Part No.      Shaft Dia.      Type

8824	1/16"	E Type
8825	3/32"	E Type
8836	3/32"	Reinforced E
3165	1/8"	Reinforced E
8826	1/8"	E Type
3166	3/16"	Reinforced E
8827	3/16"	E Type
3167	1/4"	Reinforced E
8828	1/4"	E Type
3628	5/16"	Reinforced E
3824	5/16"	E Type
5600	3/8"	Reinforced E
8829	3/8"	E Type
2672	7/16"	Reinforced E
8830	7/16"	E Type
8837	1/2"	Reinforced E
5602	1/2"	E Type
5601	9/16"	Reinforced E
5603	5/8"	E Type
8831	3/4"	E Type
8832	7/8"	E Type
8833	1"	E Type
8834	1-3/16"	E Type
8835	1-3/8"	E Type



**No. 6116 "Fix-Kit"**

Basic Internal &  
External Rings  
Zinc Plated  
24 Varieties - 1000 Pieces

Auveco Part No.      Shaft Diameter

**Internal Type**

8688	1/4"
8689	5/16"
8690	3/8"
8691	7/16"
8692	1/2"
8693	9/16"
8694	5/8"
8695	3/4"
8696	7/8"
8697	1"
8698	1-1/8"
8699	1-1/4"

**External Type**

8701	1/4"
8702	5/16"
8703	3/8"
8704	7/16"
8705	1/2"
8706	9/16"
8707	5/8"
8708	3/4"
8709	7/8"
8710	1"
8711	1-1/8"
8712	1-1/4"



**No. 6112 "Fix-Kit"**

Hammer-lock  
Cotter Pins  
Bright Zinc Chromate  
16 Varieties - 1500 Pieces

Auveco Part No.      Size

8477	1/16" x 1/2"
8478	1/16" x 3/4"
8479	1/16" x 1"
8480	1/16" x 1-1/2"
8481	3/32" x 3/4"
8482	3/32" x 1"
8484	3/32" x 1-1/2"
8485	3/32" x 2"
8486	1/8" x 1"
8487	1/8" x 1-1/4"
8488	1/8" x 1-1/2"
8490	1/8" x 2"
8491	1/8" x 1-1/2"
8492	5/32" x 1"
8493	5/32" x 1-1/2"
8494	5/32" x 2"



**No. 6113 "Fix-Kit"**

Hammer-lock  
Cotter Pins  
Bright Zinc Chromate  
8 Varieties - 350 Pieces

Auveco Part No.      Size

8495	3/16" x 1-1/2"
8497	3/16" x 2-1/2"
8498	1/4" x 1-1/2"
8499	1/4" x 2"
8500	1/4" x 2-1/2"
8501	1/4" x 3"
8502	5/16" x 2-1/2"
8503	5/16" x 3"

**ACTUAL SIZE  
ILLUSTRATIONS  
OF RETAINING RINGS  
AND "E" CLIPS  
APPEAR ON  
PAGES 119 - 125**



**No. 6110 “Fix-Kit”**  
 Hammer-lock  
 Cotter Pins  
 Plain Steel  
 12 Varieties - 800 Pieces

Auveco Part No.	Size
8506	5/32" x 1-1/4"
8507	5/32" x 1-1/2"
8508	5/32" x 1-3/4"
8509	5/32" x 2"
8511	5/32" x 2-1/2"
14908	5/32" x 3"
14909*	3/16" x 1"
8516	3/16" x 1-1/2"
8518	3/16" x 2"
8497	3/16" x 2-1/2"
8521	3/16" x 3"
8530	1/4" x 3"

\*Plated

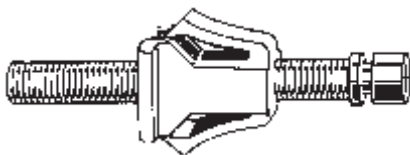

**No. 6169 “Fix-Kit”**  
 Headlight Adjusting  
 Screw & Nut Assemblies  
 GM - Ford Chrysler  
 12 Varieties - 120 Pieces

Contains the following Auveco Part Numbers: **10224, 11243, 11470, 11653, 11655, 11660, 11662, 11826, 11848, 11869, 12140 & 18780.**



**No. 6051 “Fix-Kit”**  
 Hammer-lock  
 Cotter Pins  
 Plain Steel  
 18 Varieties - 2790 Pieces

Auveco Part No.	Size
3502	1/16" x 1/2"
3503	1/16" x 3/4"
3504	1/16" x 1"
3505	1/16" x 1-1/4"
3506	1/16" x 1-1/2"
3508	1/16" x 2"
3509	3/32" x 1/2"
8481*	3/32" x 3/4"
3511	3/32" x 1"
3512	3/32" x 1-1/4"
3513	3/32" x 1-1/2"
3515	3/32" x 2"
3519	1/8" x 3/4"
3520	1/8" x 1"
3521	1/8" x 1-1/4"
3522	1/8" x 1-1/2"
8489*	1/8" x 1-3/4"
3524	1/8" x 2"

\*Plated



**No. 6117 “Fix-Kit”**  
 Rubber “O” Rings  
 12 Varieties - 120 Pieces

Auveco Part No.	Inside Diameter	Outside Diameter
4323	1"	1-1/4"
4324	1-1/16"	1-5/16"
4347	1-1/8"	1-3/8"
4348	1-3/16"	1-7/16"
4349	1-1/4"	1-1/2"
4350	1-5/16"	1-9/16"
4351	1-3/8"	1-5/8"
4352	1-7/16"	1-11/16"
4353	1-1/2"	1-3/4"
4354	1-1/2"	1-7/8"
4355	1-5/8"	2"
4356	1-3/4"	2-1/8"



**No. 6158 “Fix-Kit”**  
 Metric Cotter Pins  
 15 Sizes - 680 Pieces

Auveco Part No.	Size
10553	2 x 18mm
10554	2 x 20mm
10555	2 x 22mm
10556	2 x 25mm
10558	3 x 25mm
10559	3 x 30mm
10560	3 x 35mm
10562	4 x 30mm
10563	4 x 35mm
10564	4 x 40mm
10565	5 x 30mm
10566	5 x 35mm
10567	5 x 40mm
10568	5 x 45mm
14641	5 x 63mm



**No. 6085 “Fix-Kit”**  
 Rubber “O” Rings  
 20 Varieties - 300 Pieces

Auveco Part No.	Inside Diameter	Outside Diameter
4305	1/8"	1/4"
4306	5/32"	9/32"
4307	3/16"	5/16"
4308	7/32"	11/32"
4309	1/4"	3/8"
4310	5/16"	7/16"
4311	3/8"	1/2"
4312	3/8"	9/16"
4313	7/16"	5/8"
4314	1/2"	11/16"
4315	9/16"	3/4"
4316	5/8"	13/16"
4317	11/16"	7/8"
4318	3/4"	15/16"
4319	3/4"	1"
4320	13/16"	1-1/16"
4321	7/8"	1-1/8"
4322	15/16"	1-3/16"
4323	1"	1-1/4"
4324	1-1/16"	1-5/16"

# Sec. 15

# "6000" SERIES SMALL DRAWER "FIX-KITS"

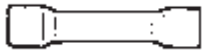

## 6175 "Fix-Kit"

Vinyl Insulated Solderless Terminals  
24 Varieties - 164 Pieces

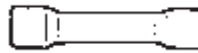

## No. 6173 "Fix-Kit"

Insulated Solderless Terminals  
23 Varieties - 125 Pieces

Auveco Part No.	Wire Ga.	Stud Size	Type
5023	22-18	#8 - #10	Ring
5026	16-14	#8 - #10	Ring
5027	16-14	#12 - 1/4"	Ring
5028	12-10	#8 - #10	Ring
5029	12-10	#12 - 1/4"	Ring
5030	12-10	1/4" - 5/16"	Ring
5031	12-10	5/16" - 3/8"	Ring
5047	22-18		Butt Connector
5048	16-14		Butt Connector
5049	12-10		Butt Connector
5067	16-14		Male Quick-Connect
5068	16-14		Female Quick-Connect
8781	16-14		Female Quick-Connect
9481	18-14		Electrical Connector
10719	16-14		Female Bullet Plug
11602	16-14		Female Bullet Plug
11605	16-14		Male Quick-Connect
11606	16-14		Female Quick-Connect
12144	16-14	5/16"-3/8"	Ring
12154	22-18		Male Quick-Connect
12155	22-18		Female Quick-Connect
12156	12-10		Male Quick-Connect
12157	12-10		Female Quick-Connect
12161	18-14		Tap Connector

Auveco Part No.	Wire Ga.	Stud Size	Type
5073	—		Snap Plug Connector
5791	22-16		Butt Connector
5792	16-14		Butt Connector
5793	12-10		Butt Connector
9052	16-14	#4 - #6	Nylon Insulated Ring
9055	16-14	#8 - #10	Nylon Insulated Ring
9056	16-14	#12 - 1/4"	Nylon Insulated Ring
9481	18-14		Electrical Connector
10719	16-14		Female Snap Plug
11600	—		Snap Plug Connector
11602	16-14		Female Snap Plug
11605	16-14		Male Quick Slide
11606	16-14		Female Quick Slide
12145	16-14		Nylon Bullet Connector
12146	16-14		Nylon Bullet Connector
12147	18-14		Nylon Male Quick Connect
12148	16-14		Nylon Female Quick Connect
12149	22-18	#6	Nylon Insulated Ring
12150	22-18	#10	Nylon Insulated Ring
12151	12-10	#10	Nylon Insulated Ring
12152	12-10	1/4"	Nylon Insulated Ring
12153	12-10	3/8"	Nylon Insulated Ring
12161	18-14		Tap Connector

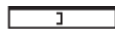

## No. 6059 "Fix-Kit"

Solderless Terminals  
Insulated & Non-insulated  
31 Varieties-480 Pieces



Auveco Part No.	Wire Ga.	Type
5043	16-14	Non-Insulated Flag Type
5044	22-16	Non-Insulated Butt Connector
5045	16-14	Non-Insulated Butt Connector
5046	12-10	Non-Insulated Butt Connector
5047	22-16	Insulated Butt Connector
5048	16-14	Insulated Butt Connector
5049	12-10	Insulated Butt Connector
5055	16-14	Insulated 3-Way "Y" Connector
5056	12-10	Insulated 3-Way "Y" Connector
5057	16-14	Insulated 4-Way "X" Connector
5058	12-10	Insulated 4-Way "X" Connector
5059	16-14	Non-Insulated Snap Plug
5060	16-14	Non-Insulated Snap Plug
5062	16-14	Insulated Snap Plug
5063	16-14	Insulated Snap Plug
5066	18-14	Non-Insulated Female Quick Connect

Auveco Part No.	Wire Ga.	Type
5067	18-14	Insulated Male Quick Connect
5068	18-14	Insulated Female Quick Connect
5069	7mm	Coil & Distributor Cap Terminal
5070	7mm	90° Spark Plug Terminal
5071	7mm	Straight Spark Plug Terminal
5072	16-10	Insulated Closed End Connector
5073	—	Insulated Snap Plug Connector
8781	16-14	Insulated Female Quick Connect
9065	22-14	Insulated Closed End Connector
9481	18-14	Electrical Connector
10719	16-14	Insulated Female Snap Plug
11602	16-14	Insulated Female Snap Plug
11605	16-14	Insulated Male Quick Connect
11606	16-14	Insulated Female Quick Connect
12161	18-14	Tap Connector



# "6000" SERIES SMALL DRAWER "FIX-KITS"™

**Sec. 15**

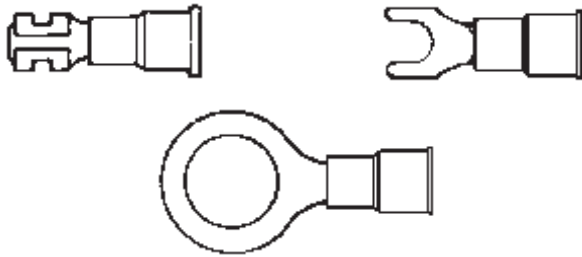

**No. 6174 "Fix-Kit"**  
Insulated Solderless Terminals  
24 Varieties - 8 Types - 160 Pieces

Auveco Part No.	Wire Ga.	Stud Size	Type
5032	12-10	7/16" -1/2"	Ring
5035	16-14	#4 -#6	Spade
5036	16-14	#8 -#10	Spade
5037	12-10	#8 -#10	Spade
5055	16-14		3-Way "Y" Connector
5056	12-10		3-Way "Y" Connector
5060	16-14		Non-Insulated Snap Plug
5072	18-10		Closed End Connector
5905	1/4"		Tab Inline Connector
8009	—		Dual Male-Female Adapter
9065	22-14		Closed End Connector
10319	18-14		Bullet Receptacle Connector
11405	—		Male Fuse Clip Adapter
11827	22-18	1/4"	Female Quick Connect
11828	22-18	1/4"	Male Quick Connect
11829	12-10	1/4"	Female Quick Connect
11830	12-10	1/4"	Male Quick Connect
12144	16-14	5/16" -3/8"	Ring
12154	22-18	1/4"	Male Quick Connect
12155	22-18	1/4"	Female Quick Connect
12156	12-10	1/4"	Male Quick Connect
12157	12-10	1/4"	Female Quick Connect
12158	16-14		Quick Connect Adapter
12159	22-18	3/16"	Female Quick Connect



**No. 6178 "Fix-Kit"**  
O.E.M. Electrical Terminals & Tools  
GM, Ford & Chrysler  
24 Varieties - 149 Pieces

Contains the following Auveco Part Numbers: **8774, 8776, 11947, 11948, 14153, 14154, 14462, 14880, 14881, 14882, 14883, 14884, 14885, 14887, 14888, 14889, 14892, 14893, 14894, 15497, 15498, 15499, 15504 & 16004**

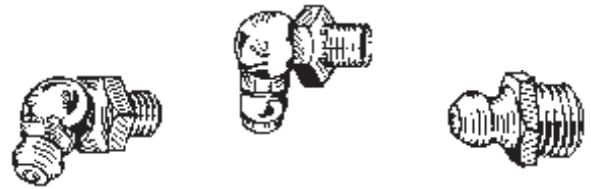

**No. 6128 "Fix-Kit"**  
Grease Fittings  
11 Varieties - 135 Pieces

Auveco Part No.	Size	Type
9257	1/4" -28	Thread-Straight (Short)
9258	1/4" -28	Thread-Straight (Long)
9259	1/4" -28	Thread-Straight (Extra Long)
9260	1/4" -28	Thread 45° Angle
9261	1/4" -28	Thread 90° Angle
9262	1/8" Pipe	Thread-Straight
9264	1/8" Pipe	Thread 45° Angle
9265	1/8" Pipe	Thread 67-1/2° Angle
9266	1/8" Pipe	Thread 90° Angle
9267	1/8" Pipe	Thread-Straight-Extra Long
15066	1/8" Pipe	Thread-Straight-(Self-Tapping)

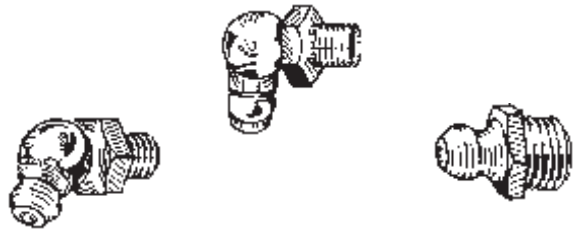

**No. 6187 "Fix-Kit"**  
Metric Grease Fittings  
12 Varieties - 165 Pieces

Auveco Part No.	Size
11097	6mm-1.00, Straight
11775	6mm-1.00, 45°
11776	6mm-1.00, 90°
11098	8mm-1.00, Straight
11777	8mm-1.00, 45°
11099	8mm-1.00, 90°
11778	8mm-1.25, Straight
11779	8mm-1.25, 45°
11780	8mm-1.25, 90°
11100	10mm-1.00, Straight
15067	10mm-1.00, 45°
11101	10mm-1.00, 90°

# Sec. 15

# "6000" SERIES SMALL DRAWER "FIX-KITS"

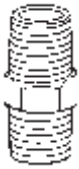

## No. 6121 "Fix-Kit"

Brass Pipe Fittings  
43 Varieties - 133 Pieces

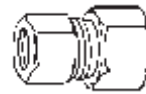

## No. 6119 "Fix-Kit"

Brass Compression Fittings  
40 Varieties - 154 Pieces

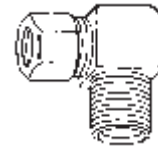

Auveco Part No.	Pipe Thread	Type
289	1/8"	Slotted Plug
290	1/4"	Slotted Plug
291	1/8"	Square Head Plug
292	1/4"	Square Head Plug
293	3/8"	Square Head Plug
295	1/8"	Hex Head Plug
296	1/4"	Hex Head Plug
297	3/8"	Hex Head Plug
331	1/8"	Coupling
332	1/4"	Coupling
333	3/8"	Coupling
340	1/8"	Union
341	1/4"	Union
347	1/8"	45° Street Elbow
348	1/4"	45° Street Elbow
349	3/8"	45° Street Elbow
350	1/8"	90° Pipe Elbow
351	1/4"	90° Pipe Elbow
352	3/8"	90° Pipe Elbow
353	1/8"	Cross
354	1/4"	Cross
355	1/8"	Tee
358	1/8"	Male Branch Tee
359	1/8"	Street Tee
299	1/4" x 1/8"	Bushing
300	3/8" x 1/8"	Bushing
301	3/8" x 1/4"	Bushing
305	1/8"	Close Nipple (3/4" Long)
306	1/4"	Close Nipple (7/8" Long)
307	3/8"	Close Nipple (1" Long)
309	1/8"	Long Nipple (1-1/2" Long)
310	1/8"	Long Nipple (2" Long)
316	1/8" x 1/8"	Hex Nipple
317	1/4" x 1/4"	Hex Nipple
318	1/4" x 1/8"	Hex Nipple
325	1/8" x 1/8"	Adaptor
326	1/4" x 1/8"	Adaptor
335	1/4" x 1/8"	Reducing Coupling
336	3/8" x 1/8"	Reducing Coupling
337	3/8" x 1/4"	Reducing Coupling
342	1/8" x 1/8"	90° Street Elbow
343	1/4" x 1/4"	90° Street Elbow
344	3/8" x 3/8"	90° Street Elbow

Auveco Part No.	Tube Size	Type
101	1/8"	Sleeve
102	3/16"	Sleeve
103	3/4"	Sleeve
104	5/16"	Sleeve
105	3/8"	Sleeve
111	3/16"	Nut
112	1/4"	Nut
113	5/16"	Nut
114	3/8"	Nut
151	3/16"	Union
152	1/4"	Union
153	5/16"	Union
154	3/8"	Union
186	3/16"	Union Tee
187	1/4"	Union Tee
188	5/16"	Union Tee
189	3/8"	Union Tee

Auveco Part No.	Tube Size	Pipe Thread	Type
119	1/8"	1/8"	Male Connector
120	3/16"	1/8"	Male Connector
121	1/4"	1/8"	Male Connector
122	1/4"	1/4"	Male Connector
123	5/16"	1/8"	Male Connector
124	5/16"	1/4"	Male Connector
125	3/8"	1/8"	Male Connector
126	3/8"	1/4"	Male Connector
134	1/8"	1/8"	Female Connector
136	1/4"	1/8"	Female Connector
159	3/16"	1/8"	Male Elbow
160	1/4"	1/8"	Male Elbow
161	1/4"	1/4"	Male Elbow
162	5/16"	1/8"	Male Elbow
163	5/16"	1/4"	Male Elbow
172	1/4"	1/8"	Male Run Tee
173	5/16"	1/8"	Male Run Tee
181	3/16"	1/8"	Male Branch Tee
182	1/4"	1/8"	Male Branch Tee
183	5/16"	1/8"	Male Branch Tee
185	1/2"	3/8"	Male Branch Tee

Auveco Part No.	Tube Size	Ext. Thread	Int. Thread	Type
177	3/16"	1/8"	1/8"	Adapter Tee
178	1/4"	1/8"	1/8"	Adapter Tee

# "6000" SERIES SMALL DRAWER "FIX-KITS"®

# Sec. 15



**No. 6065 "Fix-Kit"**  
Woodruff Keys  
1035 Carbon Steel  
20 Varieties - 383 Pieces

Auveco Part No.	Size	
3877	1/8" x 1/2"	No. 3
3878	1/8" x 5/8"	No. 5
3879	1/8" x 3/4"	No. 7
3880	3/32" x 5/8"	No. 4
3881	5/32" x 5/8"	No. 6
3882	5/32" x 3/4"	No. 8
3883	5/32" x 7/8"	No. 10
3884	3/16" x 3/4"	No. 9
3885	3/16" x 7/8"	No. 11
3886	3/16" x 1"	No. 13
3887	3/16" x 1-1/8"	No. 16
3888	7/32" x 7/8"	No. 12
3889	7/32" x 1"	No. 14
3890	7/32" x 1-1/8"	No. 17
3891	1/4" x 7/8"	No. A
3892	1/4" x 1"	No. 15
3893	1/4" x 1-1/8"	No. 18
3894	1/4" x 1-1/4"	No. 21
3895	5/16" x 1"	No. B
3896	5/16" x 1-1/8"	No. C



**No. 6067 "Fix-Kit"**  
Cup Expansion Plugs  
Zinc Plated  
18 Varieties - 166 Pieces

Auveco Part No.	Size	
3952	7/16"	
3953	1/2"	
3956	5/8"	
3957	3/4"	
3958	7/8"	
15212	15/16"	
3960	1"	
3961	1-1/8"	
3962	1-3/16"	
3963	1-1/4"	
3964	1-3/8"	
3965	1-1/2"	
3966	1-5/8"	
3967	1-3/4"	
3968	1-7/8"	
3969	1-15/16"	
3970	1-61/64"	
3971	2"	



**No. 6060 "Fix-Kit"**  
Universal Clevis Pins  
& Cotter Pins  
7 Varieties - 64 Pieces  
Of Clevis Pins  
2 Varieties - 60 Pieces  
Of Cotter Pins

Auveco Part No.	Size	
<b>Clevis Pins</b>		
3703	1/4" x 2"	
3704	5/16" x 2"	
3705	3/8" x 2"	
3706	7/16" x 2"	
3707	1/2" x 2"	
3708	7/16" x 2-1/2"	
3709	1/2" x 2-1/2"	
<b>Cotter Pins</b>		
3511	3/32" x 1"	
3521	1/8" x 1-1/4"	



**No. 6139 "Fix-Kit"**  
Clevis Pins  
Zinc Plated  
15 Varieties - 142 Pieces

Auveco Part No.	Size	
9433	1/4" Dia. x 1"	
9434	1/4" Dia. x 1-1/8"	
9435	5/16" Dia. x 1"	
9436	5/16" Dia. x 1-1/8"	
9437	5/16" Dia. x 1-1/4"	
9438	5/16" Dia. x 1-3/8"	
9439	5/16" Dia. x 1-3/4"	
9440	3/8" Dia. x 1"	
9441	3/8" Dia. x 1-1/8"	
9442	3/8" Dia. x 1-3/16"	
9443	3/8" Dia. x 1-1/4"	
9444	3/8" Dia. x 1-1/2"	
9445	3/8" Dia. x 1-3/4"	
9446	1/2" Dia. x 1-1/2"	
9447	1/2" Dia. x 1-3/4"	



**No. 6125 "Fix-Kit"**  
Spring Pins  
Zinc Plated  
20 Varieties - 600 Pieces

Auveco Part No.	Size	
9013	5/32" x 1/2"	
9015	5/32" x 3/4"	
9016	5/32" x 1"	
9017	5/32" x 1-1/4"	
9018	5/32" x 1-1/2"	
9019	3/16" x 1/2"	
9021	3/16" x 3/4"	
9022	3/16" x 1"	
9023	3/16" x 1-1/4"	
9024	3/16" x 1-1/2"	
9025	3/16" x 1-3/4"	
9026	3/16" x 2"	
9030	1/4" x 5/8"	
9031	1/4" x 3/4"	
9033	1/4" x 1"	
9034	1/4" x 1-1/4"	
9035	1/4" x 1-1/2"	
9036	1/4" x 1-3/4"	
9037	1/4" x 2"	
9038	1/4" x 2-1/4"	



**No. 6124 "Fix-Kit"**  
Spring Pins  
Zinc Plated  
24 Varieties - 1475 Pieces

Auveco Part No.	Size	
8981	1/16" x 3/16"	
8983	1/16" x 1/2"	
8985	1/16" x 3/4"	
8987	1/16" x 1"	
8988	5/64" x 1/4"	
8989	5/64" x 1/2"	
8991	5/64" x 3/4"	
8992	5/64" x 1"	
8993	5/64" x 1-1/4"	
8994	5/64" x 1-1/2"	
8995	3/32" x 5/16"	
8996	3/32" x 1/2"	
8998	3/32" x 3/4"	
9000	3/32" x 1"	
9001	3/32" x 1-1/4"	
9002	3/32" x 1-1/2"	
9003	1/8" x 3/8"	
9004	1/8" x 1/2"	
9006	1/8" x 3/4"	
9008	1/8" x 1"	
9009	1/8" x 1-1/4"	
9010	1/8" x 1-1/2"	
9011	1/8" x 1-3/4"	
9012	1/8" x 2"	

**Sec. 15**

**"6000" SERIES SMALL DRAWER "FIX-KITS"**

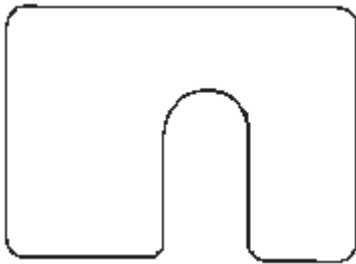

**No. 6166 "Fix-Kit"**  
Body And Fender Shims  
Zinc Plated  
4 Varieties - 400 Pieces

Auveco Part No.	Size
<b>2452</b>	1-3/4" x 1-1/4" x 1/16" Thick (1/2" Slot)
<b>2453</b>	1-3/4" x 1-1/4" x 1/8" Thick (1/2" Slot)
<b>3155</b>	1-1/4" x 1-1/8" x 1/16" Thick (3/8" Slot)
<b>3156</b>	1-1/4" x 1-1/8" x 1/8" Thick (3/8" Slot)

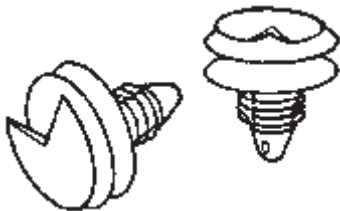

**No. 6162 "Fix-Kit"**  
"Xmas Tree"  
Fastener Trim Kit  
GM-Ford-Chrysler  
8 Varieties - 320 Pieces

Contains the following Auveco Part Numbers: **10621, 11351, 11672, 11673, 11678, 11679, 11721, & 11797.**



**No. 6062 "Fix-Kit"**  
Plug Buttons; Nickel Plated  
7 Varieties - 300 Pieces

Auveco Part No.	Hole Size
<b>3750</b>	1/4"
<b>3751</b>	3/8"
<b>3752</b>	1/2"
<b>3753</b>	5/8"
<b>3754</b>	3/4"
<b>3755</b>	7/8"
<b>3756</b>	1"



**No. 6133 "Fix-Kit"**  
Steel  
Tubing Clamps  
Vinyl Coated  
Zinc Plated  
8 Varieties - 200 Pieces

Auveco Part No.	Tube Dia.	Hole Dia.	Width
<b>9381</b>	1/4"	9/32"	1/2"
<b>9382</b>	5/16"	9/32"	1/2"
<b>9383</b>	3/8"	9/32"	1/2"
<b>9384</b>	1/2"	9/32"	1/2"
<b>9385</b>	5/8"	9/32"	1/2"
<b>9386</b>	3/4"	9/32"	1/2"
<b>9387</b>	7/8"	9/32"	1/2"
<b>9388</b>	1"	9/32"	1/2"



**No. 6176 "Fix-Kit"**  
Thread Repair Inserts  
& Installation Tool  
12 Varieties - 40 Pieces

Auveco Part No.	Internal Thread Size
<b>12374</b>	#10-24
<b>12375</b>	#10-32
<b>12376</b>	1/4"-20
<b>12377</b>	1/4"-28
<b>12378</b>	5/16"-18
<b>12379</b>	5/16"-24
<b>12380</b>	3/8"-16
<b>12381</b>	3/8"-24
<b>12382</b>	7/16"-14
<b>12383</b>	7/16"-20
<b>12384</b>	1/2"-13
<b>12385</b>	1/2"-20
<b>12404</b>	Installation Tools



**No. 6168 "Fix-Kit"**  
Hose Connectors  
Barbed On All Sides  
7 Sizes - 155 Pieces

Auveco Part No.	Size
<b>10101</b>	1/8" x 1/8"
<b>10102</b>	3/16" x 3/16"
<b>10103</b>	1/4" x 1/4"
<b>10104</b>	5/16" x 5/16"
<b>10105</b>	3/8" x 3/8"
<b>10106</b>	1/4" x 3/16"
<b>10107</b>	3/8" x 1/4"



**No. 6167 "Fix-Kit"**  
Tee Connectors  
Barbed On All Sides  
6 Sizes - 72 Pieces

Auveco Part No.	Hose Size
<b>10697</b>	1/8"
<b>10108</b>	5/32"
<b>10109</b>	3/16"
<b>10110</b>	1/4"
<b>11228</b>	3/8"
<b>11229</b>	1/2"

Come And Visit Our  
Web Site

[www.auveco.com](http://www.auveco.com)



**4-96 Cabinet & 4 Empty Large Drawers**  
 (24 Compartment Drawers With Locking Latches)  
 20" Wide x 15-3/4" Deep x 14-1/2" High  
 Finish: Light Green Enamel  
 Drawer Size: 18" Wide x 12" Deep x 3" High

**2-96 Empty Cabinet.** Will Hold 4 Large Drawers.

**3-96 Empty Cabinet.** Will Hold 2 Large Drawers  
 20" Wide x 15-3/4" Deep x 8" High  
 Finish: Light Green Enamel  
 Drawer Size: Same as 4-96



**B-3**

Base For 2-96, 3-96 & 4-96  
 Raises unit 15" off the floor for more convenient  
 use of the bottom drawer  
 Finish: Light Green Enamel

UNIT PACKAGE: 1



No. 1-924

**Empty Drawers With Locking Latches** (18" Wide x 12" Deep x 3" High)  
 Available in 12, 16, 20, 21, 24 and 32 compartment layouts.

**1-900** Adjustable Compartment Empty Drawer With  
 3 Vertical and 3 Horizontal Dividers

**1-901** Adjustable Compartment Empty Drawer With  
 9 Dividers

**1-912** 12 Compartment Empty Drawer

**1-916** 16 Compartment Empty Drawer

**1-920** 20 Compartment Empty Drawer

**1-921** 21 Compartment Empty Drawer

**1-924** 24 Compartment Empty Drawer

**1-932** 32 Compartment Empty Drawer



Auveco offers 35 pre-packaged "Fix-Kits<sup>®</sup>" in the "6500" series large drawer. A drawer measures 18" Wide x 12" Deep x 3" High with the compartments designed to hold the entire contents of one or more standard Auveco unit packages. Printed lid labels identify the correct Auveco part number for ordering refills.

**"6500" Series Large Drawer "Fix-Kit<sup>®</sup>" Numeric Listing**

Auveco Part No.	Description	Auveco Part No.	Description
<b>6500</b>	Slotted Pan Head Tapping Screws	<b>6522</b>	"Xmas Tree" Retainers
<b>6501</b>	Phillips Oval Head Tapping Screws	<b>6523</b>	Tee Connectors & Rubber Caps
<b>6502</b>	Tubular, Flat, "U" & "J" Nuts	<b>6524</b>	Well Nuts <sup>®</sup> & Jack Nuts <sup>®</sup>
<b>6503</b>	Round Head Machine Screws & Nuts	<b>6525</b>	Nylon Rivets
<b>6504</b>	Woodruff Keys	<b>6526</b>	O.E.M. Electrical Terminals
<b>6505</b>	"O" Rings	<b>6530</b>	Phillips Washer Head Tapping Screws
<b>6506</b>	Cotter Pins	<b>6531</b>	Stainless Steel Torx <sup>®</sup> Screws
<b>6507</b>	Internal & External Retaining Rings	<b>6532</b>	Stainless Steel Screws, Nuts & Washers
<b>6508</b>	"E" Rings	<b>6533</b>	Stainless Steel Tapping Screws
<b>6509</b>	Spring Pins	<b>6534</b>	Oil Drain Plugs
<b>6510</b>	Spring Pins	<b>6535</b>	Extension Springs
<b>6511</b>	Grease Fittings	<b>6536</b>	Teks <sup>®</sup> Tapping Screws
<b>6513</b>	Metric Cap Screws & Nuts	<b>6537</b>	Door Hinge Pins & Bushings
<b>6514</b>	Metric Cap Screws & Nuts	<b>6538</b>	Cylinder Head & Manifold Studs
<b>6517</b>	Nylon Nuts	<b>6539</b>	Phillips Pan Head Machine Screws & Nuts
<b>6519</b>	GM "Xmas Tree" Retainers	<b>6540</b>	Metric Body Bolts & Nuts
<b>6520</b>	Ford "Xmas Tree" Retainers	<b>6541</b>	U.S.S. Grade 5 Cap Screws & Nuts

**"6500" Series/"6000" Series Kit Cross Reference**

"6500" Kit	"6000" Kit	"6500" Kit	"6000" Kit	"6500" Kit	"6000" Kit
<b>6500</b>	6001	<b>6507</b>	6116	<b>6526</b>	6178
<b>6501</b>	6003	<b>6508</b>	6123	<b>6530</b>	6182
<b>6502</b>	6007	<b>6509</b>	6124	<b>6532</b>	6184
<b>6503</b>	6011	<b>6510</b>	6125	<b>6533</b>	6185
<b>6504</b>	6065	<b>6511</b>	6128	<b>6534</b>	6186
<b>6505</b>	6085	<b>6513</b>	6160	<b>6536</b>	6144
<b>6506</b>	6112	<b>6514</b>	6161		

The New 6600 Series Body Hardware Master Assortments are listed on pages 265 - 267

# "6500" SERIES LARGE DRAWER "FIX-KITS"®



**No. 6501 "Fix-Kit"**  
Phillips Oval Head Tapping Screws  
Zinc & Chrome Plated  
24 Varieties - 540 Pieces

Auveco Part No.	Size	Head
3069	4 x 3/4"	
1793	6 x 5/8"	
1794	6 x 3/4"	
1796	6 x 1"	
1797	6 x 1-1/4"	
2024	8 x 3/8"	No.6
2358	8 x 1/2"	
2027	8 x 1/2"	No. 6
1421	8 x 5/8"	No. 6
1799	8 x 3/4"	No. 6
2359	8 x 3/4"	
1801	8 x 1"	No. 6
1802	8 x 1-1/8"	No. 6
2361	8 x 1-1/4"	
1803	8 x 1-1/4"	No. 6
2362	8 x 1-1/2"	
1932	8 x 1-1/2"	No. 6
1933	8 x 1-3/4"	No. 6
1717	10 x 3/4"	No. 8
2728	10 x 3/4"	
1804	10 x 1"	No. 6
1807	10 x 1-1/8"	
2046	10 x 1-1/2"	No. 6
2047	10 x 1-3/4"	No. 6



**No. 6500 "Fix-Kit"**  
Slotted Pan Head Tapping Screws  
Zinc Plated  
24 Varieties - 1050 Pieces

Auveco Part No.	Size
1728	6 x 1/4"
1263	6 x 3/8"
1452	6 x 1/2"
1453	6 x 5/8"
1454	6 x 3/4"
1455	6 x 1"
1456	8 x 3/8"
1146	8 x 1/2"
1092	8 x 5/8"
1147	8 x 3/4"
1457	8 x 1"
1730	10 x 3/8"
1458	10 x 1/2"
1787	10 x 5/8"
1265	10 x 3/4"
1459	10 x 1"
1460	10 x 1-1/2"
1266	10 x 1-3/4"
1343	12 x 1/2"
1344	12 x 3/4"
1346	12 x 1"
1347	14 x 1/2"
1381	14 x 3/4"
1382	14 x 1"



**No. 6531 "Fix-Kit"**  
Stainless Steel Metric Oval Head And  
Pan Head Torx® Tapping Screws  
20 Varieties - 670 Pieces

Auveco Part No.	Size	Head
11937	M4.2-1.41 x 20mm	Chrome
14950	M4.2-1.41 x 20mm	Chrome
14569	M4.2-1.41 x 25mm	Chrome
11939	M4.2-1.41 x 30mm	Chrome
11941	M4.2-1.41 x 40mm	Chrome
11938	M4.2-1.41 x 20mm	Blk Ox
14570	M4.2-1.41 x 20mm	Blk Ox
14053	M4.2-1.41 x 25mm	Blk Ox
11940	M4.2-1.41 x 30mm	Blk Ox
14047	M4.2-1.41 x 35mm	Blk Ox
14572	M4.2-1.41 x 13mm	Chrome
11943	M4.2-1.41 x 20mm	Chrome
14049	M4.2-1.41 x 25mm	Chrome
11945	M4.2-1.41 x 35mm	Chrome
14052	M4.2-1.41 x 16mm	Blk Ox
11944	M4.2-1.41 x 20mm	Blk Ox
14051	M4.2-1.41 x 20mm	Blk Ox
14046	M4.2-1.41 x 25mm	Blk Ox
14050	M4.2-1.41 x 30mm	Blk Ox
14952	M4.2-1.41 x 55mm	Blk Ox

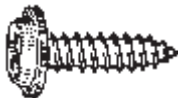

**No. 6530 "Fix-Kit"**  
Phillips Flat Top Washer Head  
Tapping Screws  
Black "E" Coat Plated  
12 Varieties - 1790 Pieces

Auveco Part No	Size	Head
12950	#6 x 1/2"	Black E Coat
12951	#6 x 3/4"	Black E Coat
12213	#8 x 1/2"	Black E Coat
12214	#8 x 5/8"	Black E Coat
12215	#8 x 3/4"	Black E Coat
12216	#8 x 1"	Black E Coat
12217	#8 x 1-1/4"	Black E Coat
12218	#8 x 1-1/2"	Black E Coat
12953	#10 x 3/4"	Black E Coat
12954	#10 x 1"	Black E Coat
14859	#8 x 1/2"	Zinc
14861	#8 x 3/4"	Zinc



**No. 6533 "Fix-Kit"**  
Stainless Steel Phillips Head  
Tapping Screws  
24 Varieties - 1600 Pieces

Auveco Part No.	Size	Head
9399	#6 x 1/2"	Oval
9400	#6 x 3/4"	Oval
9401	#6 x 1"	Oval
9403	#8 x 1/2"	Oval
9404	#8 x 3/4"	Oval
9405	#8 x 1"	Oval
9406	#8 x 1-1/4"	Oval
9407	#8 x 1-1/2"	Oval
9409	#10 x 3/4"	Oval
9410	#10 x 1"	Oval
9412	#12 x 1-1/2"	Oval
13265	#6 x 1/2"	Pan
13266	#6 x 3/4"	Pan
13267	#6 x 1"	Pan
13269	#8 x 1/2"	Pan
13270	#8 x 3/4"	Pan
13271	#8 x 1"	Pan
13272	#8 x 1-1/4"	Pan
13273	#8 x 1-1/2"	Pan
13274	#10 x 1/2"	Pan
13275	#10 x 3/4"	Pan
13276	#10 x 1"	Pan
13277	#10 x 1-1/4"	Pan
13278	#10 x 1-1/2"	Pan

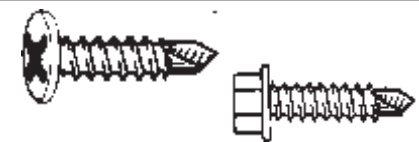

**No. 6536 "Fix-Kit"**  
Teks® Self-Drilling Screws  
Pozi-Driv Pan Head  
Hex Washer Head  
Zinc Plated  
16 Varieties - 365 Pieces

Auveco Part No.	Size	Head
9605	#8 x 1/2"	Pan
9606	#8 x 3/4"	Pan
9607	#10 x 1/2"	Pan
9608	#10 x 3/4"	Pan
11905	#12 x 1"	Pan
9611	#8 x 1/2"	Hex
9612	#8 x 3/4"	Hex
9613	#10 x 1/2"	Hex
9614	#10 x 5/8"	Hex
9615	#10 x 3/4"	Hex
9616	#10 x 1"	Hex
11911	#12 x 1"	Hex
9620	#14 x 3/4"	Hex
11914	#14 x 1"	Hex
11915	#14 x 1-1/4"	Hex
11916	#14 x 1-1/2"	Hex

**Sec. 15**

**"6500" SERIES LARGE DRAWER "FIX-KITS"**

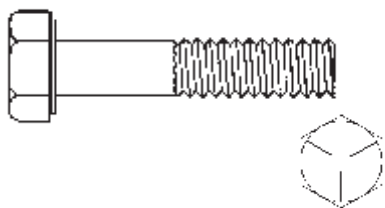

**No. 6541 "Fix-Kit"**

U.S.S. Grade 5  
Cap Screws With Nuts  
Zinc Plated  
15 Varieties  
270 Screws - 270 Nuts

Auveco Part No.	Size
5434	1/4"-20 x 1/2"
5436	1/4"-20 x 3/4"
5438	1/4"-20 x 1"
5440	1/4"-20 x 1-1/2"
5449	5/16"-18 x 3/4"
5451	5/16"-18 x 1"
5453	5/16"-18 x 1-1/2"
5455	5/16"-18 x 2"
5465	3/8"-16 x 1"
5466	3/8"-16 x 1-1/4"
5467	3/8"-16 x 1-1/2"
5469	3/8"-16 x 2"
15586	1/4"-20 Hex Nut
15587	5/16"-18 Hex Nut
15588	3/8"-16 Hex Nut



**No. 6514 "Fix-Kit"**

Metric Regular Pitch  
Cap Screws & Nuts  
DIN 933  
Zinc Plated  
15 Varieties - 128 Pieces

Auveco Part No.	Size
14424	M8-1.25 x 40mm
14425	M8-1.25 x 45mm
14426	M8-1.25 x 50mm
14431	M10-1.50 x 25mm
14432	M10-1.50 x 30mm
14433	M10-1.50 x 35mm
14434	M10-1.50 x 40mm
14436	M10-1.50 x 50mm
14440	M12-1.75 x 25mm
14441	M12-1.75 x 30mm
14442	M12-1.75 x 35mm
14443	M12-1.75 x 40mm
14452	M8-1.25 Nut
14454	M10-1.50 Nut
14455	M12-1.75 Nut



**No. 6503 "Fix-Kit"**

Slotted Round Head  
Machine Screws  
Zinc Plated  
19 Varieties of Screws  
5 Varieties of Nuts  
1110 Pieces

Auveco Part No.	Size
727	#6-32 Nut
728	#8-32 Nut
729	#10-32 Nut
730	#10-24 Nut
731	#12-24 Nut
2530	#6-32 x 1/2"
2531	#6-32 x 3/4"
2532	#6-32 x 1"
2533	#8-32 x 1/2"
2534	#8-32 x 3/4"
2535	#8-32 x 1"
2536	#10-32 x 1/2"
2537	#10-32 x 3/4"
2538	#10-32 x 1"
2539	#10-32 x 1-1/4"
2540	#10-32 x 1-1/2"
2541	#10-24 x 1/2"
2542	#10-24 x 3/4"
2543	#10-24 x 1"
2544	#10-24 x 1-1/4"
2545	#10-24 x 1-1/2"
2546	#12-24 x 1/2"
2548	#12-24 x 1"
2550	#12-24 x 1-1/2"



**No. 6513 "Fix-Kit"**

Metric Regular Pitch  
Cap Screws & Nuts  
DIN 933  
Zinc Plated  
16 Varieties - 236 Pieces

Auveco Part No.	Size
14400	M4-.7 x 16mm
14401	M4-.7 x 20mm
14402	M5-.8 x 10mm
14403	M5-.8 x 16mm
14404	M5-.8 x 20mm
14405	M5-.8 x 25mm
14408	M6-1.0 x 16mm
14409	M6-1.0 x 20mm
14410	M6-.10 x 25mm
14420	M8-1.25 x 20mm
14421	M8-1.25 x 25mm
14422	M8-1.25 x 30mm
14448	M4-.7 Nut
14449	M5-.8 Nut
14450	M6-1.0 Nut
14452	M8-1.25 Nut

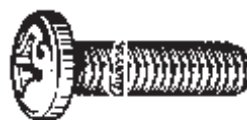

**No. 6539 "Fix-Kit"**

Phillips Pan Head  
Machine Screws & Nuts  
Zinc Plated  
12 Varieties of Screws  
4 Varieties of Nuts  
2160 Pieces

Auveco Part No.	Size
15381	#8-32 x 1/2"
15382	#8-32 x 3/4"
15383	#8-32 x 1"
15387	#10-24 x 1/2"
15388	#10-24 x 3/4"
15389	#10-24 x 1"
15393	#10-32 x 1/2"
15394	#10-32 x 3/4"
15395	#10-32 x 1"
15398	1/4"-20 x 1/2"
15399	1/4"-20 x 3/4"
15400	1/4"-20 x 1"
728	#8-32 Hex Nut
729	#10-32 Hex Nut
730	#10-24 Hex Nut
733	1/4"-20 Hex Nut



**No. 6532 "Fix-Kit"**

Stainless Steel Cap Screws,  
Nuts & Washers  
24 Varieties - 660 Pieces

Auveco Part No.	Size
13346	1/4"-20 x 1/2"
13347	1/4"-20 x 3/4"
13348	1/4"-20 x 1"
13349	1/4"-20 x 1-1/4"
13350	1/4"-20 x 1-1/2"
13352	1/4"-20 x 2"
13354	5/16"-18 x 3/4"
13355	5/16"-18 x 1"
13356	5/16"-18 x 1-1/4"
13357	5/16"-18 x 1-1/2"
13359	5/16"-18 x 2"
13364	3/8"-16 x 1"
13365	3/8"-16 x 1-1/4"
13366	3/8"-16 x 1-1/2"
13368	3/8"-16 x 2"
13234	1/4"-20 Hex Nut
13235	5/16"-18 Hex Nut
13236	3/8"-16 Hex Nut
13395	Bolt Size: 1/4" Flat Wshr
13396	Bolt Size: 5/16" Flat Wshr
13397	Bolt Size: 3/8" Flat Wshr
13403	Bolt Size: 1/4" Lock Wshr
13404	Bolt Size: 5/16" Lock Wshr
13405	Bolt Size: 3/8" Lock Wshr



# "6500" SERIES LARGE DRAWER "FIX-KITS"®

**Sec. 15**

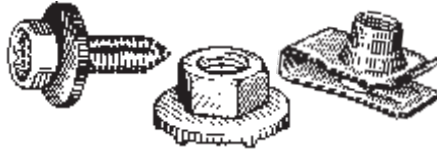

## No. 6540 "Fix-Kit"

Metric Body Bolts & Nuts  
8 Varieties of Bolts  
6 Varieties of Extruded "U" Nuts  
4 Varieties of Free Spinning Washer Nuts  
2 Varieties of Hex Flange Nuts  
252 Pieces

Auveco Part No.	Size
12693	M6-1.0 x 20mm
12065	M6-1.0 x 25mm
12066	M6-1.0 x 25mm
11633	M6.3-1.0 x 20mm
11935	M6.3-1.0 x 25mm
13613	M8-1.25 x 25mm
13614	M8-1.25 x 30mm
11641	M10-1.50 x 40mm
11644	M8-1.25 Hex Flange Nut
11645	M10-1.5 Hex Flange Nut
12595	M6-1.0 Free Spin Wshr Nut
15329	M6-1.0 Free Spin Wshr Nut
11642	M6.3-1.0 Free Spin Wshr Nut
15335	M8-1.25 Free Spin Wshr Nut
12669	M6-1.0 Extruded "U" Nut
12575	M6-1.0 Extruded "U" Nut
11628	M6.3-1.0 Extruded "U" Nut
11630	M8-1.25 Extruded "U" Nut
11629	M8-1.25 Extruded "U" Nut
11631	M10-1.5 Extruded "U" Nut

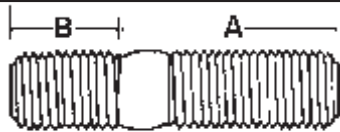

## No. 6538 "Fix-Kit"

Cylinder Head & Manifold Studs  
24 Varieties - 120 Pieces

Auveco Part No.	Dimensions A	Dimensions B
9667	1/4"-28 x 7/16"	1/4"-20 x 7/16"
9669	1/4"-28 x 3/4"	1/4"-20 x 1/2"
9674	5/16"-24 x 5/8"	5/16"-18 x 1/2"
9675	5/16"-24 x 5/8"	5/16"-18 x 3/4"
9676	5/16"-24 x 7/8"	5/16"-18 x 9/16"
9677	5/16"-24 x 1"	5/16"-18 x 9/16"
9679	5/16"-18 x 7/8"	5/16"-18 x 7/16"
9683	3/8"-24 x 3/4"	3/8"-16 x 1/2"
9684	3/8"-24 x 3/4"	3/8"-16 x 1/2"
9686	3/8"-24 x 1"	3/8"-16 x 5/8"
9687	3/8"-16 x 1-1/8"	3/8"-16 x 5/8"
14827	3/8"-16 x 1-1/2"	3/8"-16 x 7/16"
9689	3/8"-24 x 1"	3/8"-16 x 3/4"
9690	3/8"-24 x 2"	3/8"-16 x 5/8"
9692	3/8"-16 x 1-5/8"	3/8"-16 x 7/16"
14828	3/8"-16 x 1-5/8"	3/8"-16 x 7/16"
9701	7/16"-20 x 7/8"	7/16"-14 x 3/4"
9705	7/16"-20 x 3/4"	7/16"-14 x 3/4"
9711	7/16"-14 x 1-1/4"	7/16"-14 x 3/4"
9715	7/16"-20 x 1-13/16"	7/16"-14 x 3/4"
9731	1/2"-20 x 1"	1/2"-13 x 3/4"
9732	1/2"-20 x 2"	1/2"-13 x 3/4"
11982	M8-1.25 x 22mm; M8-1.25 x 10mm	40mm Overall
11983	M8-1.25 x 22mm; M8-1.25 x 10mm	45mm Overall

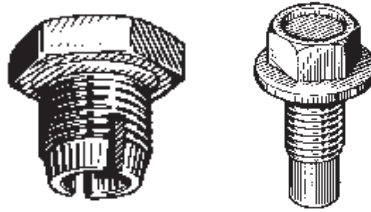

## No. 6534 "Fix-Kit"

Oil Drain Plugs & Gaskets  
12 Varieties - 94 Pieces

Auveco Part No.	Size
14196	1/2"-20
11782	1/2"-20 Oversize "Piggy-Back"
18121	1/2"-20 Double Oversize
18122	1/2"-20 Triple Oversize
8285	5/8"-18 Oversize
15527	M12-1.25x 11mm
14677	M12-1.25x 26mm
14678	M14-1.5
16308	M14-1.5
15528	M16.4 Oversize
15529	M18-1.5
15530	M20-1.5

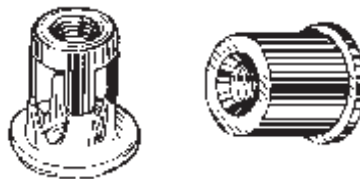

## No. 6524 "Fix-Kit"

Special Purpose Well Nuts & Jack Nuts (O.E.M. Application)  
GM -Ford -Chrysler -AMC  
12 Varieties - 170 Pieces

Contains the following Auveco Part Numbers: **12999, 12998, 12997, 12995, 13005, 13004, 13002, 13000, 13231, 13016, 13010 and 13009.**

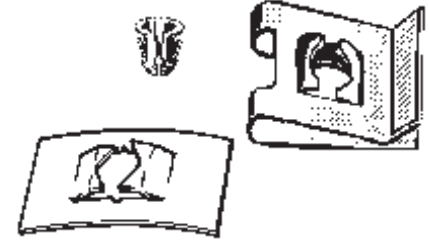

## No. 6502 "Fix-Kit"

Tubular, Flat, "U" & "J" Nuts  
24 Varieties - 515 Pieces

Auveco Part No.	Size	
1903	1/4"-20	Flat
2089	#6-32	Flat
2092	#10-24	Flat
2099	1/8" Stud	Flat
2103	3/16" Stud	Flat
2105	1/4" Stud	Flat
2293	1/4"-20	"U"
2346	#8	"J"
2422	#10	"U"
2595	1/8" Stud	Tubular
2611	1/8" Stud	Tubular
5170	3/8"-16	"J"
5197	#10-24	"U"
5586	1/4"-20	"J" Cage
5589	5/16"-18	"J" Cage
9879	#8	Spring "U"
9880	#8	Spring "U"
10064	#6	Spring "U"
10065	#8	Spring "U"
10066	#10	Spring "U"
10067	#14	Spring "U"
10666	#8	"U"
11292	#8	"U"
11429	#10	"U"



## No. 6535 "Fix-Kit"

Extension Springs  
12 Varieties - 92 Pieces

Auveco Part No.	Length
14074	1-1/4"
14072	1-7/16"
14069	2-19/32"
14063	3-1/4"
14064	4"
14067	4"
14066	4-1/16"
14065	4-1/2"
14061	5-5/8"
14062	5-3/4"
14059	6-7/16"
14060	6-1/2"

**Sec. 15**

**"6500" SERIES LARGE DRAWER "FIX-KITS"**



**No. 6507 "Fix-Kit"**

Basic Internal & External Rings  
Zinc Plated  
24 Varieties - 1000 Pieces

Auveco Part No.	Shaft Diameter
-----------------	----------------

**Internal Type**

8688	1/4"
8689	5/16"
8690	3/8"
8691	7/16"
8692	1/2"
8693	9/16"
8694	5/8"
8695	3/4"
8696	7/8"
8697	1"
8698	1-1/8"
8699	1-1/4"

**External Type**

8701	1/4"
8702	5/16"
8703	3/8"
8704	7/16"
8705	1/2"
8706	9/16"
8707	5/8"
8708	3/4"
8709	7/8"
8710	1"
8711	1-1/8"
8712	1-1/4"

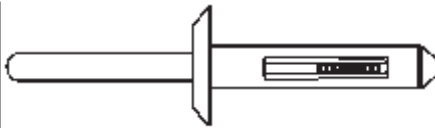

**No. 6525 "Fix-Kit"**

Black Nylon Blind Rivets  
14 Varieties - 340 Pieces

Auveco Part No.	Size
-----------------	------

13746	3/16"; Grip: 1/16"-9/64"
13747	13/64"; Grip: 1/16"-11/64"
14005	13/64"; Grip: 1/8"-5/32"
13748	13/64"; Grip: 1/8"-15/64"
13755	13/64"; Grip: 15/64"-25/64"
14004	15/64"; Grip: 11/64"-11/32"
14023	15/64"; Grip: 5/32"-5/16"
13749	1/4"; Grip: 5/32"-15/64"
	White
14012	1/4"; Grip: 5/32"-13/32"
	White
13751	1/4"; Grip: 5/32"-13/32"
13750	1/4"; Grip: 5/32"-13/32"
17101	1/4"; Grip: 5/16"-15/32"
13752	17/64"; Grip: 3/32"-3/16"
13753	17/64"; Grip: 3/32"-3/16"



**No. 6508 "Fix-Kit"**

"E" & Reinforced "E" Rings  
Groove Required  
24 Varieties - 1500 Pieces

Auveco Part No.	Shaft Dia.	Type
-----------------	------------	------

8824	1/16"	E Type
8825	3/32"	E Type
8836	3/32"	Reinforced E
3165	1/8"	Reinforced E
8826	1/8"	E Type
3166	3/16"	Reinforced E
8827	3/16"	E Type
3167	1/4"	Reinforced E
8828	1/4"	E Type
3628	5/16"	Reinforced E
3824	5/16"	E Type
5600	3/8"	Reinforced E
8829	3/8"	E Type
2672	7/16"	Reinforced E
8830	7/16"	E Type
8837	1/2"	Reinforced E
5602	1/2"	E Type
5601	9/16"	Reinforced E
5603	5/8"	E Type
8831	3/4"	E Type
8832	7/8"	E Type
8833	1"	E Type
8834	1-3/16"	E Type
8835	1-3/8"	E Type

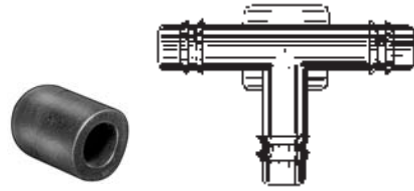

**No. 6523 "Fix-Kit"**

Nylon Connectors & Rubber Caps  
24 Varieties - 320 Sizes

Auveco Part No.	Size
-----------------	------

Nylon Connectors		
12929	1/8" x 1/8"	Straight
12930	1/8" x 3/16"	Straight
12936	1/8" x 1/4"	Straight
12937	3/16" x 3/16"	Straight
12935	1/4" x 3/16"	Straight
12931	1/4" x 1/4"	Straight
12923	1/8" x 1/8" x 1/8"	Teel
12916	1/8" x 1/8" x 3/16"	Teel
12926	3/16" x 1/8" x 3/16"	Teel
12918	3/16" x 3/16" x 3/16"	Teel
12919	1/4" x 3/16" x 3/16"	Teel
11738	1/4" x 3/16" x 1/4"	Teel
12921	3/8" x 1/4" x 3/8"	Teel
12920	5/16" x 5/16" x 5/16"	Teel
12927	3/16" x 3/16" x 3/16"	"Y"
12948	3/16" x 1/4"	Elbow
12939	3/16"	Cross
11419	3/16"	4-Way
12949	3/16"	5-Way

**Rubber Caps**

12209	For 1/8" O.D.	Tube
4440	For 3/16" O.D.	Tube
4439	For 1/4" O.D.	Tube
12210	For 3/8" O.D.	Tube
12907	For 5/16" O.D.	Tube

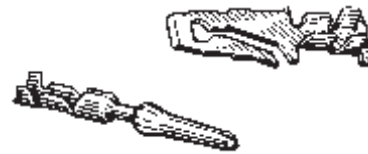

**No. 6526 "Fix-Kit"**

O.E.M. Electrical Terminals & Tools  
GM, Ford & Chrysler  
24 Varieties - 149 Pieces

Contains the following Auveco Part Numbers: **8774, 8776, 11947, 11948, 14153, 14154, 14462, 14880, 14881, 14882, 14883, 14884, 14885, 14887, 14888, 14889, 14892, 14893, 14894, 15497, 15498, 15499, 15504 & 16004.**

# "6500" SERIES LARGE DRAWER "FIX-KITS"®

# Sec. 15



**No. 6505 "Fix-Kit"**  
Rubber "O" Rings  
20 Varieties - 300 Pieces

Auveco Part No.	I.D.	O.D.
4305	1/8"	1/4"
4306	5/32"	9/32"
4307	3/16"	5/16"
4308	7/32"	11/32"
4309	1/4"	3/8"
4310	5/16"	7/16"
4311	3/8"	1/2"
4312	3/8"	9/16"
4313	7/16"	5/8"
4314	1/2"	11/16"
4315	9/16"	3/4"
4316	5/8"	13/16"
4317	11/16"	7/8"
4318	3/4"	15/16"
4319	3/4"	1"
4320	13/16"	1-1/16"
4321	7/8"	1-1/8"
4322	15/16"	1-3/16"
4323	1"	1-1/4"
4324	1-1/16"	1-5/16"



**No. 6509 "Fix-Kit"**  
Spring Pins  
Zinc Plated  
24 Varieties - 1475 Pieces

Auveco Part No.	Size
8981	1/16" x 3/16"
8983	1/16" x 1/2"
8985	1/16" x 3/4"
8987	1/16" x 1"
8988	5/64" x 1/4"
8989	5/64" x 1/2"
8991	5/64" x 3/4"
8992	5/64" x 1"
8993	5/64" x 1-1/4"
8994	5/64" x 1-1/2"
8995	3/32" x 5/16"
8996	3/32" x 1/2"
8998	3/32" x 3/4"
9000	3/32" x 1"
9001	3/32" x 1-1/4"
9002	3/32" x 1-1/2"
9003	1/8" x 3/8"
9004	1/8" x 1/2"
9006	1/8" x 3/4"
9008	1/8" x 1"
9009	1/8" x 1-1/4"
9010	1/8" x 1-1/2"
9011	1/8" x 1-3/4"
9012	1/8" x 2"



**No. 6510 "Fix-Kit"**  
Spring Pins  
Zinc Plated  
20 Varieties - 600 Pieces

Auveco Part No.	Size
9013	5/32" x 1/2"
9015	5/32" x 3/4"
9016	5/32" x 1"
9017	5/32" x 1-1/4"
9018	5/32" x 1-1/2"
9019	3/16" x 1/2"
9021	3/16" x 3/4"
9022	3/16" x 1"
9023	3/16" x 1-1/4"
9024	3/16" x 1-1/2"
9025	3/16" x 1-3/4"
9026	3/16" x 2"
9030	1/4" x 5/8"
9031	1/4" x 3/4"
9033	1/4" x 1"
9034	1/4" x 1-1/4"
9035	1/4" x 1-1/2"
9036	1/4" x 1-3/4"
9037	1/4" x 2"
9038	1/4" x 2-1/4"



**No. 6504 "Fix-Kit"**  
Woodruff Keys  
1035 Carbon Steel  
20 Varieties - 383 Pieces

Auveco Part No.	Size	No.
3877	1/8" x 1/2"	No. 3
3878	1/8" x 5/8"	No. 5
3879	1/8" x 3/4"	No. 7
3880	3/32" x 5/8"	No. 4
3881	5/32" x 5/8"	No. 6
3882	5/32" x 3/4"	No. 8
3883	5/32" x 7/8"	No. 10
3884	3/16" x 3/4"	No. 9
3885	3/16" x 7/8"	No. 11
3886	3/16" x 1"	No. 13
3887	3/16" x 1-1/8"	No. 16
3888	7/32" x 7/8"	No. 12
3889	7/32" x 1"	No. 14
3890	7/32" x 1-1/8"	No. 17
3891	1/4" x 7/8"	No. A
3892	1/4" x 1"	No. 15
3893	1/4" x 1-1/8"	No. 18
3894	1/4" x 1-1/4"	No. 21
3895	5/16" x 1"	No. B
3896	5/16" x 1-1/8"	No. C



**No. 6506 "Fix-Kit"**  
Hammer-lock  
Cotter Pins  
Bright Zinc Chromate  
16 Varieties - 1500 Pieces

Auveco Part No.	Size
8477	1/16" x 1/2"
8478	1/16" x 3/4"
8479	1/16" x 1"
8480	1/16" x 1-1/2"
8481	3/32" x 3/4"
8482	3/32" x 1"
8484	3/32" x 1-1/2"
8485	3/32" x 2"
8486	1/8" x 1"
8487	1/8" x 1-1/4"
8488	1/8" x 1-1/2"
8490	1/8" x 2"
8491	1/8" x 2-1/2"
8492	5/32" x 1"
8493	5/32" x 1-1/2"
8494	5/32" x 2"



**No. 6511 "Fix-Kit"**  
Grease Fittings  
11 Varieties - 135 Pieces

Auveco Part No.	Type
9257	1/4" - 28 Thread-Straight (Short)
9258	1/4" - 28 Thread-Straight (Long)
9259	1/4" - 28 Thread-Straight (Extra Long)
9260	1/4" - 28 Thread - 45°
9261	1/4" - 28 Thread - 90°
9262	1/8" Pipe Thread - Straight
9264	1/8" Pipe Thread - 45°
9265	1/8" Pipe Thread - 67-1/2°
9266	1/8" Pipe Thread - 90°
9267	1/8" Pipe Thread - Straight Extra Long
15066	1/8" Pipe Straight-Self-Tapping

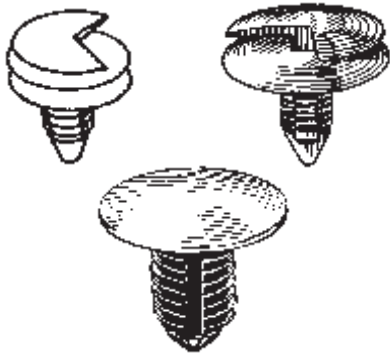

**No. 6519 "Fix-Kit"**

"Xmas Tree" Retainers  
GM  
12 Varieties - 500 Pieces

Contains the following Auveco Part Numbers: **10621, 10831, 10832, 11120, 11678, 11679, 11721, 11796, 12137, 12737, 12766 & 15461.**

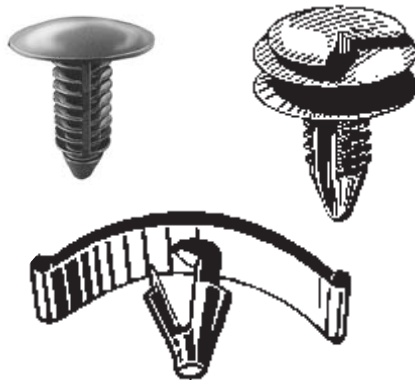

**No. 6522 "Fix-Kit"**

"Xmas Tree" Retainers  
GM, Ford & Chrysler  
12 Varieties - 550 Pieces

Contains the following Auveco Part Numbers: **10332, 10621, 10831, 10832, 11136, 11146, 11351, 11672, 11678, 11796, 12137 & 12737.**

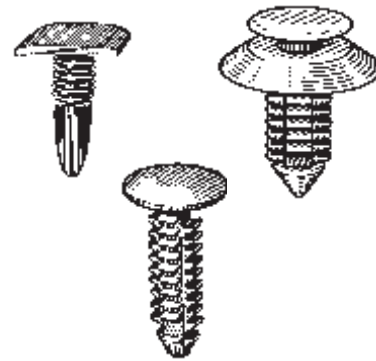

**No. 6520 "Fix-Kit"**

"Xmas Tree" Retainers  
Ford  
12 Varieties - 465 Pieces

Contains the following Auveco Part Numbers: **8853, 11136, 11351, 11671, 11672, 11679, 11797, 11842, 12565, 12571, 14757 & 17339.**

Do You Have An Idea For  
A New Assortment?

E-mail Your Suggestions  
to [mail@auveco.com](mailto:mail@auveco.com)

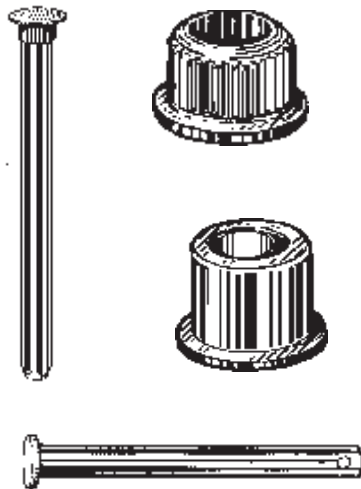

**No. 6537 "Fix-Kit"**

Door Hinge Pins & Bushings  
16 Varieties - 221 Pieces

**Bushings**

14548, 14549, 14550, 14551,  
14552, 14553, 16936, 16937,  
17167 & 17434.

**Pins**

14559, 14561, 14562, 17437,  
19183 & 19424

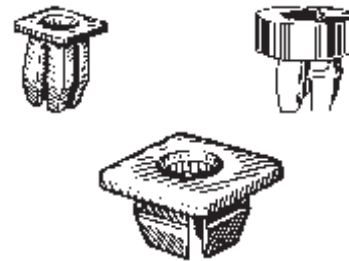

**No. 6517 "Fix-Kit"**

Nylon Nuts  
16 Varieties - 850 Pieces

Contains the following Auveco Part Numbers: **2625, 3682, 5228, 8419, 8435, 9377, 9829, 9851, 9862, 10330, 11368, 11691, 11719, 11720, 11838, 11855.**

**"Fix-Kit"  
Lid Labels  
Are Available For  
Updating Assortments.  
Refer To Page 270.**



Translucent Durable Polypropylene Boxes  
With Locking Tabs  
6-3/4" x 11" x 1-3/4"

**6 Compartment Box**

**68-6** UNIT PACKAGE: 1  
**68-106** UNIT PACKAGE: 10

**12 Compartment Box**

**68-12** UNIT PACKAGE: 1  
**68-112** UNIT PACKAGE: 10

**18 Compartment Box**

**68-18** UNIT PACKAGE: 1  
**68-118** UNIT PACKAGE: 10



**68-RACK**

Empty Cabinet. Will Hold 5 Quik-Select Kits.  
11-1/4" Wide x 6-3/4" Deep x 10-3/4" High  
Finish: Gray Enamel  
Keyhole slots are furnished for wall mounting.  
A handle is provided and bolt holes permit stacking.



Fast moving body hardware and specialty fasteners in convenient, translucent, durable polypropylene boxes. Our Quik-Select Assortments offer popular coverage in an economical package that makes choosing the correct part fast and easy. Assortments come in 6, 12 and 18 compartment layouts complete with O.E.M. numbers, sizes, specifications and the proper Auveco part number for ordering refills.

**Quik-Select Assortments Numeric Listing**

Auveco Part No.	Description	Auveco Part No.	Description	Auveco Part No.	Description
<b>6801</b>	GM "Xmas Tree" Retainers	<b>6827</b>	Rubber Grommets	<b>6850</b>	Black Phillips Oval Head Tapping Screws
<b>6802</b>	Ford "Xmas Tree" Retainers	<b>6829</b>	Honda Body Hardware	<b>6851</b>	Zinc & Black Phillips Pan Head Tapping Screws
<b>6803</b>	Chrysler "Xmas Tree" Retainers	<b>6830</b>	Hair Pin Cotter	<b>6852</b>	Stainless Steel Tapping Screws
<b>6804</b>	GM Push-Type Retainers	<b>6831</b>	Plastic Plug Buttons	<b>6853</b>	Specialty Screws
<b>6805</b>	Ford Push-Type Retainers	<b>6832</b>	Mazda Body Hardware	<b>6854</b>	Metric Specialty Screws
<b>6806</b>	Nylon Rivets	<b>6833</b>	Nissan Body Hardware	<b>6856</b>	External & Internal Lock Washers
<b>6807</b>	Nylon Nuts	<b>6834</b>	Toyota Body Hardware	<b>6857</b>	Thread Cutting & Washer Lock Nuts
<b>6808</b>	License Plate Hardware	<b>6835</b>	Rubber "O" Rings	<b>6858</b>	Pushnut Bolt Retainers
<b>6809</b>	Window Reveal Moulding Clips	<b>6836</b>	Nylon Connectors	<b>6859</b>	Hose Connectors
<b>6810</b>	Sems® Screws	<b>6837</b>	Honda Body Hardware	<b>6860</b>	Buna "N" O-Rings
<b>6811</b>	Specialty Screws	<b>6838</b>	Nissan Body Hardware	<b>6861</b>	Spring Pins
<b>6812</b>	Black Tapping Screws	<b>6839</b>	Toyota Body Hardware	<b>6862</b>	"E" Type Retaining Rings
<b>6813</b>	Teks® Screws	<b>6840</b>	Pan'l Blind Rivets	<b>6863</b>	External & Internal Retaining Rings
<b>6814</b>	Body Bolts	<b>6841</b>	Specialty Rivets	<b>6864</b>	Door Lock Rod Clips
<b>6815</b>	Tubular, Flat, "U" & "J" Nuts	<b>6842</b>	Nylon Insulated Terminals	<b>6865</b>	Weatherstrip Retainers
<b>6816</b>	Extruded "U" Nuts	<b>6843</b>	Vinyl Insulated Terminals	<b>6866</b>	Rubber Bumpers
<b>6817</b>	Washer Type Nuts & Push-On Retainers	<b>6844</b>	Insulated Quick-Connect Terminals	<b>6867</b>	Wire Loom Clips
<b>6818</b>	Cotter Pins	<b>6845</b>	GM "Xmas Tree" Retainers	<b>6868</b>	Shims
<b>6820</b>	Oil Drain Plug Gaskets	<b>6846</b>	Ford "Xmas Tree" Retainers	<b>6869</b>	Fender Washers
<b>6821</b>	Glass Shop Rivets	<b>6847</b>	Chrysler "Xmas Tree" Retainers		
<b>6822</b>	GM Window Guides	<b>6848</b>	Chrome Phillips Oval Head Tapping Screws		
<b>6823</b>	Phillips Oval Head Tapping Screws	<b>6849</b>	Zinc Phillips Oval Head Tapping Screws		
<b>6825</b>	Oil Drain Plug Gaskets				
<b>6826</b>	Rubber Vacuum Caps				

**Sec. 15**

**"6800" SERIES QUIK-SELECT ASSORTMENTS**



**No. 6823**

Phillips Oval Head  
Tapping Screws  
Plated

18 Varieties - 307 Pieces

Auveco  
Part No.          Size

1798	#8 x 3/4" w/#6 Hd., Zinc
2359	#8 x 3/4", Zinc
1801	#8 x 1" w/#6 Hd., Zinc
2360	#8 x 1", Zinc
2581	#10 x 3/4", Zinc
2582	#10 x 1", Zinc
1799	#8 x 3/4" w/#6 Hd., Chrome
2710	#8 x 3/4", Chrome
1483	#8 x 1", w/#6 Hd., Chrome
2713	#8 x 1", Chrome
2728	#10 x 3/4", Chrome
2731	#10 x 1", Chrome
10164	#8 x 3/4" w/#6 Hd., Bk. Ox.
10165	#8 x 3/4" Bk. Ox.
10166	#8 x 1" w/#6 Hd., Bk. Ox.
10167	#8 x 1" Bk. Ox.
11086	#10 x 3/4" Bk. Ox.
11088	#10 x 1" Bk. Ox.



**No. 6848**

Phillips Oval Head Tapping Screws  
Chrome Plated  
18 Varieties - 200 Pieces

Auveco  
Part No.          Size

2698	#6 x 1/2"
1794	#6 x 3/4"
1796	#6 x 1"
2707	#8 x 1/2"
2027	#8 x 1/2" w/ #6 Head
2710	#8 x 3/4"
1799	#8 x 3/4" w/ #6 Head
2713	#8 x 1"
1483	#8 x 1" w/ #6 Head
2716	#8 x 1-1/4"
1423	#8 x 1-1/4" w/ #6 Head
2718	#8 x 1-1/2"
1932	#8 x 1-1/2" w/ #6 Head
1933	#8 x 1-3/4" w/ #6 Head
2728	#10 x 3/4"
1717	#10 x 3/4" w/ #8 Head
2731	#10 x 1"
2730	#10 x 1" w/ #8 Head



**No. 6849**

Phillips Oval Head Tapping Screws  
Zinc Plated

12 Varieties - 418 Pieces

Auveco  
Part No.          Size

2700	#6 x 3/4"
2702	#6 x 1"
2358	#8 x 1/2"
2706	#8 x 1/2" w/ #6 Head
2359	#8 x 3/4"
1798	#8 x 3/4" w/ #6 Head
2360	#8 x 1"
1801	#8 x 1" w/ #6 Head
2361	#8 x 1-1/4"
1803	#8 x 1-1/4" w/ #6 Head
2717	#8 x 1-1/2" w/ #6 Head
2632	#8 x 2" w/ #6 Head



**No. 6850**

Phillips Oval Head Tapping Screws  
Black Oxide Plated  
18 Varieties - 339 Pieces

Auveco  
Part No.          Size

12795	#6 x 1/2"
12796	#6 x 3/4"
12797	#6 x 1"
10163	#8 x 1/2"
10162	#8 x 1/2" w/ #6 Head
10165	#8 x 3/4"
10164	#8 x 3/4" w/ #6 Head
10167	#8 x 1"
10166	#8 x 1" w/ #6 Head
10169	#8 x 1-1/4"
10168	#8 x 1-1/4" w/ #6 Head
10171	#8 x 1-1/2"
10170	#8 x 1-1/2" w/ #6 Head
11086	#10 x 3/4"
11087	#10 x 3/4" w/ #8 Head
11088	#10 x 1"
11089	#10 x 1" w/ #8 Head
11092	#10 x 1-1/2"



**No. 6810**

Sems® Screws  
Plated

18 Varieties - 140 Pieces

Auveco  
Part No.          Size

<b>Chrome</b>	
3538	#6 x 3/4"
2771	#8 x 5/8" w/#6 Hd.
2751	#8 x 3/4" w/#6 Hd.
11450	#8 x 3/4", Teks
2775	#8 x 7/8" w/#6 Hd., w/Flush Washer
2772	#8 x 1" w/#6 Hd.
2773	#8 x 1-1/4" w/#6 Hd.
3465	#10 x 5/8" w/#8 Hd.
3466	#10 x 3/4" w/#8 Hd.
3467	#10 x 1" w/#8 Hd.
<b>Black</b>	
11787	#8 x 5/8" w/#6 Hd.
11454	#8 x 5/8", Teks
11788	#8 x 3/4" w/#6 Hd.
11455	#8 x 3/4", Teks
11789	#8 x 1" w/ #6 Hd.
12957	#8 x 1" w/#6 Hd. w/ Flush Washer
11791	#10 x 3/4" w/#8 Hd.
11792	#10 x 1" w/#8 Hd.



**No. 6812**

Black  
Tapping Screws  
18 Varieties - 312 Pieces

Auveco  
Part No.          Size

<b>Black E Coat Phillips Flat Washer Head</b>	
12213	#8 x 1/2"
12214	#8 x 5/8"
12215	#8 x 3/4"
12216	#8 x 1"
12217	#8 x 1-1/4"
12218	#8 x 1-1/2"
12953	#10 x 3/4"
12954	#10 x 1"
<b>Black Oxide Phillips Oval Head</b>	
10162	#8 x 1/2" w/#6 Hd.
10163	#8 x 1/2"
10164	#8 x 3/4" w/#6 Hd.
10165	#8 x 3/4"
10166	#8 x 1" w/#6 Hd.
10167	#8 x 1"
10168	#8 x 1-1/4" w/#6 Hd.
10169	#8 x 1-1/4"
10170	#8 x 1-1/2" w/#6 Hd.
10171	#8 x 1-1/2"

# "6800" SERIES QUIK-SELECT ASSORTMENTS

**Sec. 15**



**No. 6851**  
Phillips Pan Head  
Tapping Screws  
Plated  
18 Varieties - 457 Pieces

Auveco Part No.	Size
Zinc	
1940	#8 x 1/2"
2365	#8 x 3/4"
3079	#8 x 1"
1943	#10 x 1/2"
2366	#10 x 3/4"
3082	#10 x 1"
2367	#12 x 3/4"
3090	#14 x 3/4"
Black Oxide	
11917	#6 x 1/2"
11918	#6 x 3/4"
10180	#8 x 1/2"
10181	#8 x 3/4"
10182	#8 x 1"
10183	#8 x 1-1/4"
12799	#8 x 1-1/2"
11921	#10 x 1/2"
11922	#10 x 3/4"
11923	#10 x 1"



**No. 6852**  
Stainless Steel Tapping Screws  
12 Varieties - 216 Pieces

Auveco Part No.	Size	Head
9400	#6 x 3/4"	Oval
9404	#8 x 3/4"	Oval
9405	#8 x 1"	Oval
9407	#8 x 1-1/2"	Oval
9409	#10 x 3/4"	Oval
9410	#10 x 1"	Oval
13269	#8 x 1/2"	Pan
13270	#8 x 3/4"	Pan
13271	#8 x 1"	Pan
13274	#10 x 1/2"	Pan
13275	#10 x 3/4"	Pan
13276	#10 x 1"	Pan

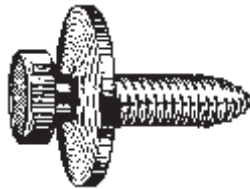

**No. 6814**  
Body Bolts  
12 Varieties - 101 Pieces

Auveco Part No.	Size
11320	5/16"-18 x 1"
12693	M6-1.0 x 20mm
12324	M6-1.0 x 20mm
12160	M6-1.0 x 22mm
12065	M6-1.0 x 25mm
12066	M6-1.0 x 25mm
12323	M6-1.0 x 25mm
12335	M6-1.0 x 28mm
12351	M6.3-1.81 x 20mm
13613	M8-1.25 x 25mm
13614	M8-1.25 x 30mm
11640	M8-1.25 x 30mm



**No. 6811**  
Specialty Screws  
12 Varieties - 387 Pieces

Auveco Part No.	Size
10642	#8 x 3/8"
9863	#8 x 3/8"
9229	#8 x 7/16"
1826	#8 x 7/16"
2805	#8 x 7/16"
13025	#8 x 1/2"
13708	#8 x 1/2"
12095	#8 x 1/2" Tek's
12739	M4.2-1.41 x 12mm
13712	M4.2-1.41 x 13mm
2806	#8 x 5/8"
13026	#8 x 3/4"

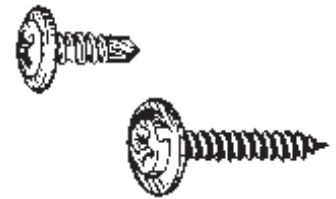

**No. 6853**  
Specialty Screws  
12 Varieties - 198 Pieces

Auveco Part No.	Size
10642	#8 x 3/8"
15037	#8 x 7/16"
2805	#8 x 7/16"
12095	#8 x 1/2"
15172	#8 x 1/2"
15774	#8 x 1/2"
2806	#8 x 5/8"
12820	#8 x 3/4"
13026	#8 x 3/4"
17650	#8 x 3/4"
13709	#10 x 3/4"
16589	#10 x 3/4"

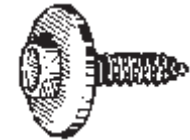

**No. 6854**  
Metric Specialty Screws  
18 Varieties - 145 Pieces

Auveco Part No.	Size
12062	M4.2-1.41 x 10mm
12739	M4.2-1.41 x 12mm
13712	M4.2-1.41 x 13mm
12741	M4.2-1.41 x 16mm
12060	M4.2-1.41 x 20mm
12738	M4.2-1.41 x 20mm
12742	M4.2-1.41 x 20mm
15373	M4.2-1.41 x 20mm
15775	M4.2-1.41 x 20mm
17459	M4.8-1.81 x 16mm
12057	M6.3-1.81 x 16mm
15962	M6.3-1.81 x 18mm
12351	M6.3-1.81 x 20mm
16828	M6.3-1.81 x 20mm
12339	M6.3-1.81 x 25mm
12068	M6.3-1.81 x 30mm
12354	M6.3-1.81 x 30mm
12350	M8-2.12 x 20mm

# Sec. 15

# "6800" SERIES QUIK-SELECT ASSORTMENTS

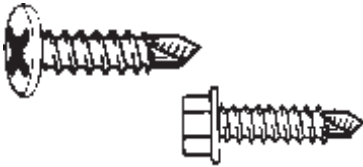

## No. 6813

Pan Head &  
Hex Washer Head  
Teks® Screws  
Zinc Plated  
18 Varieties - 127 Pieces

Auveco Part No.	Size
<b>Pan Head</b>	
12095	#8 x 1/2"
9605	#8 x 1/2"
9606	#8 x 3/4"
9607	#10 x 1/2"
9608	#10 x 3/4"
9609	#10 x 1"
<b>Hex Washer Head</b>	
9611	#8 x 1/2"
9612	#8 x 3/4"
9613	#10 x 1/2"
9614	#10 x 5/8"
9615	#10 x 3/4"
9616	#10 x 1"
11911	#12 x 1"
11913	#12 x 1-1/2"
9620	#14 x 3/4"
11914	#14 x 1"
11915	#14 x 1-1/4"
11916	#14 x 1-1/2"



## No. 6808

License Plate Hardware  
12 Varieties - 171 Pieces

Contains the following Auveco part numbers:  
1313, 2472, 2625, 3182,  
5228, 5278, 8250, 8427,  
8435, 9603, 11370,  
11719 & 14473.



## No. 6815

Nuts: Tubular, Flat,  
"J" & "U"

18 Varieties - 148 Pieces

Auveco Part No.	Size	Type
2595	1/8"	Tubular
10073	3/16"	Tubular
2099	1/8"	Flat
2092	#10-24	Flat
1903	1/4"-20	Flat
5586	1/4"-20	"J"
5589	5/16"-18	"J"
5170	3/8"-16	"J"
10666	#8	"U"
11292	#8	"U"
5197	#10-24	"U"
2293	1/4"-20	"U"
9879	#8	"U"
9880	#8	"U"
10064	#6	"U"
10065	#8	"U"
10066	#10	"U"
10067	#14	"U"



## No. 6816

Extruded "U" Nuts  
(Foldover Nuts)  
12 Varieties - 70 Pieces

Auveco Part No.	Size	Hole To Edge
8359	1/4" - 20	17/32"
10051	1/4" - 20	25/32"
10053	5/16" - 18	9/16"
8814	5/16" - 18	27/32"
10054	3/8" - 16	3/4"
10055	3/8" - 16	1-1/8"
12669	M6 - 1.0	13.5mm
12575	M6 - 1.0	19.5mm
11628	M6.3 - 1.0	13.5mm
11629	M8 - 1.25	14.5mm
11630	M8 - 1.25	20mm
11631	M10 - 1.5	19mm

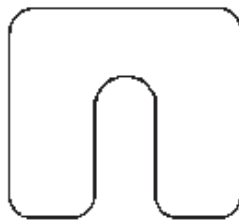

## No. 6868

Shims - Zinc Plated  
6 Varieties - 100 Pieces

Auveco Part No.	Dimensions
2453	1/8" Thick, 1-3/4" x 1-1/4"
3000	1/8" Thick, 2" x 1-1/2"
3155	1/16" Thick, 1-1/4" x 1-1/8"
3156	1/8" Thick, 1-1/4" x 1-1/8"
5076	1/16" Thick, 1-1/8" x 1-1/8"
5077	1/8" Thick, 1-1/8" x 1-1/8"



## No. 6807

Nylon Nuts & Grommets  
18 Varieties - 251 Pieces

Contains the following Auveco part numbers:  
2625, 3682, 8435, 9829, 9862,  
10330, 11368, 11691, 11719,  
11838, 11841, 11855, 12735,  
13450, 13933, 13960, 14009 &  
14031.



## No. 6801

GM "Xmas Tree" Retainers  
12 Varieties - 118 Pieces

Contains the following Auveco part numbers: 10621,  
10831, 10832, 11146, 11612,  
11678, 11796, 12137, 12731,  
12737, 12766 & 12992.



## No. 6845

GM "Xmas Tree" Retainers  
11 Varieties - 118 Pieces

Contains the following Auveco part numbers:  
11120, 12759, 13461, 14032,  
14036, 15367, 15456, 15669,  
15970, 16818 & 17664.



## No. 6802

Ford "Xmas Tree"  
Retainers  
12 Varieties - 112 Pieces

Contains the following Auveco part numbers: 10831, 11136,  
11351, 11671, 11797, 12565,  
12571, 12909, 14021, 14163,  
17612 & 19655



# "6800" SERIES QUIK-SELECT ASSORTMENTS

**Sec. 15**



## No. 6846

Ford "Xmas Tree" Retainers  
12 Varieties - 112 Pieces

Contains the following  
Auveco part numbers:

**8853, 11136, 11672, 13470,  
14757, 15478, 15479, 15480,  
17102, 17339, 19655 & 20316.**



## No. 6847

Chrysler "Xmas Tree" Retainers  
12 Varieties - 113 Pieces

Contains the following  
Auveco part numbers:

**11129, 11136, 11675, 11679,  
14921, 15481, 15543, 16818,  
17004, 17975, 18033 & 20316.**



## No. 6803

Chrysler "Xmas Tree"  
Retainers  
6 Varieties - 113 Pieces

Contains the following Auveco  
part numbers: **10831, 11136,  
11146, 11351, 11678 & 17004.**



## No. 6865

Weatherstrip Retainers  
12 Varieties - 245 Pieces

Auveco Part No.	Application
8853	Ford
10744	GM
11120	GM
11129	Chrysler
11612	Ford & GM
14328	Honda
14921	Chrysler & GM
17339	Ford
18033	Chrysler
18692	Mazda & Toyota
18877	Honda
19171	Honda

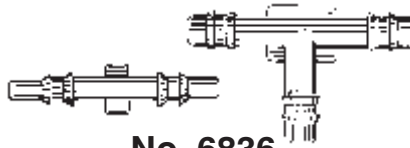

## No. 6836

Nylon Connectors  
12 Varieties - 83 Pieces

Auveco Part No.	Size
11738	1/4" x 1/4" x 3/16"
12918	3/16 x 3/16" x 3/16"
12919	1/4" x 3/16" x 3/16"
12920	5/16" x 5/16" x 5/16"
12921	3/8" x 3/8" x 1/4"
12923	1/8" x 1/8" x 1/8"
12926	3/16" x 3/16" x 1/8"
12929	1/8" x 1/8"
12930	1/8" x 3/16"
12931	1/4" x 1/4"
12935	1/4" x 3/16"
12937	3/16" x 3/16"



## No. 6859

Hose Connectors  
12 Varieties - 61 Pieces

Auveco Part No.	Size
10101	1/8" x 1/8"
10102	3/16" x 3/16"
10103	1/4" x 1/4"
10104	5/16" x 5/16"
10105	3/8" x 3/8"
10106	1/4" x 3/16"
10107	3/8" x 1/4"
10697	1/8" x 1/8" x 1/8"
10108	5/32" x 5/32" x 5/32"
10109	3/16" x 3/16" x 3/16"
10110	1/4" x 1/4" x 1/4"
11228	3/8" x 3/8" x 3/8"



## No. 6817

Washer Type  
Thread Cutting Nuts  
& Push-on Retainers  
18 Varieties - 385 Pieces

Auveco Part No.	Size
12116	5mm Stud Size
3403	1/8" Stud Size
3404	3/16" Stud Size
2896	3/16" Stud Size
2897	1/4" Stud Size
3405	1/4" Stud Size
10733	5/16" Stud Size

### Thread Cutting Nuts

### Push-On Retainers

8863	1/8" Stud Size
8864	5/32" Stud Size
8865	3/16" Stud Size
8868	1/4" Stud Size

### Bolt Retainers

10086	1/4" Bolt Size
10087	5/16" Bolt Size
9297	3/8" Bolt Size
12123	6mm Bolt Size
12125	8mm Bolt Size
12259	8mm Bolt Size
12126	10mm Bolt Size



## No. 6857

Thread Cutting & Washer Lock Nuts  
18 Varieties - 227 Pieces

Auveco Part No.	Size
2895	1/8" Stud Size
3403	1/8" Stud Size
8855	5/32" Stud Size
2896	3/16" Stud Size
3404	3/16" Stud Size
3405	1/4" Stud Size
2897	1/4" Stud Size
10733	5/16" Stud Size
12253	5mm Stud Size
12255	6.3mm Stud Size
15711	8mm Stud Size

### Thread Cutting Nuts

### Washer Lock Nuts

2554	#6-32 Thread
2555	#8-32 Thread
2557	#10-24 Thread
2558	#10-24 Thread
2560	#12-24 Thread
2561	1/4"-20 Thread
12108	M6-1.0 Thread

**Sec. 15**

**"6800" SERIES QUIK-SELECT ASSORTMENTS**



**No. 6858**

Pushnut Bolt Retainers  
18 Varieties - 314 Pieces

Auveco Part No.	Size
16851	#6 (9/64")
10085	#8 (5/32")
16852	#10 (3/16")
10086	1/4"
10087	5/16"
9297	3/8"
9298	7/16"
9299	1/2"
12122	M5-0.8
12123	M6-1.0
14980	M6-1.0
12124	M6.3-1.0
12125	M8-1.25
12259	M8-1.25
12126	M10-1.50
12260	M10-1.50
12127	M12-1.75
16980	M14-2.0



**No. 6869**

Fender Washers  
12 Varieties - 155 Pieces

Auveco Part No.	Dimensions
2007	3/16" Bolt Size, 1/2" O.D.
1183	3/16" Bolt Size, 3/4" O.D.
16018	3/16" Bolt Size, 1" O.D.
16020	1/4" Bolt Size, 1" O.D.
2333	1/4" Bolt Size, 1-1/4" O.D.
768	5/16" Bolt Size, 1-1/4" O.D.
17095	5/16" Bolt Size, 1-1/4" O.D.
1700	5/16" Bolt Size, 1-1/2" O.D.
3553	3/8" Bolt Size, 1-1/4" O.D.
2227	3/8" Bolt Size, 1-1/2" O.D.
1294	3/8" Bolt Size, 1-3/4" O.D.
17094	3/8" Bolt Size, 1-3/4" O.D.

**Remember...**  
**All Items In This Catalog**  
**Are Available In Bulk.**

**Call For A Quote**



**No. 6856**

External & Internal Lock Washers  
12 Varieties - 685 Pieces

Auveco Part No.	Size
<b>External</b>	
5251	#8 (5/32")
5252	#10 (3/16")
5254	#14 (1/4")
5255	5/16"
5256	3/8"
5257	7/16"
<b>Internal</b>	
5261	#8 (5/32")
5262	#10 (3/16")
5264	#14 (1/4")
5265	5/16"
5266	3/8"
5267	7/16"



**No. 6862**

"E" Type Retaining Rings  
12 Varieties - 343 Pieces

Auveco Part No.	Shaft Diameter
8825	3/32"
8826	1/8"
10131	5/32"
8827	3/16"
10133	7/32"
8828	1/4"
3824	5/16"
8829	3/8"
8830	7/16"
5602	1/2"
5603	5/8"
8831	3/4"



**No. 6863**

External & Internal Retaining Rings  
Zinc Plated  
18 Varieties - 151 Pieces

Auveco Part No.	Shaft Diameter
-----------------	----------------

**Internal Type**

8688	1/4"
8689	5/16"
8690	3/8"
8691	7/16"
8693	9/16"
8694	5/8"

**External Type**

8701	1/4"
8702	5/16"
8703	3/8"
8704	7/16"
8705	1/2"
8706	9/16"
8707	5/8"
8708	3/4"
8709	7/8"
8710	1"
8712	1-1/4"
10125	1-1/2"



**No. 6818**

Cotter Pins  
Zinc Plated  
18 Varieties-570 Pieces

Auveco Part No.	Size
8477	1/16" x 1/2"
8478	1/16" x 3/4"
8479	1/16" x 1"
8480	1/16" x 1-1/2"
8481	3/32" x 3/4"
8482	3/32" x 1"
8484	3/32" x 1-1/2"
8485	3/32" x 2"
8486	1/8" x 1"
8487	1/8" x 1-1/4"
8488	1/8" x 1-1/2"
8489	1/8" x 1-3/4"
8490	1/8" x 2"
8492	5/32" x 1"
8493	5/32" x 1-1/2"
8494	5/32" x 2"
8495	3/16" x 1-1/2"
8496	3/16" x 2"

# "6800" SERIES QUIK-SELECT ASSORTMENTS

**Sec. 15**



## 6830

Hair Pin Cotters  
6 Varieties - 73 Pieces

Auveco Part No.	Overall Length
10397	3-15/16"
11872	1-9/16"
10398	4"
10395	2-1/2"
10396	3-3/4"
10394	2-5/16"



## No. 6861

Spring Pins  
Zinc Plated  
12 Varieties - 174 Pieces

Auveco Part No.	Size
9006	1/8" x 3/4"
9008	1/8" x 1"
9010	1/8" x 1-1/2"
9016	5/32" x 1"
9018	5/32" x 1-1/2"
9022	3/16" x 1"
9024	3/16" x 1-1/2"
9026	3/16" x 2"
9033	1/4" x 1"
9035	1/4" x 1-1/2"
9037	1/4" x 2"
9045	5/16" x 2"



## No. 6842

Nylon Insulated  
Solderless Terminals  
12 Varieties - 100 Pieces

Auveco Part No.	Description
5791	Butt Conn., 22-18 Ga.
5792	Butt Conn., 16-14 Ga.
5793	Butt Conn., 12-10 Ga.
9055	Ring Type, 16-14 Ga.
9056	Ring Type, 16-14 Ga.
9060	Spade Type, 16-14 Ga.
12147	Male Q. C. 16-14 Ga.
12148	Female Q.C., 16-14 Ga.
12150	Ring Type, 22-18 Ga.
12151	Ring Type, 12-10 Ga.
12152	Ring Type, 12-10 Ga.
12153	Ring Type, 12-10 Ga.



## No. 6843

Vinyl Insulated  
Solderless Terminals  
12 Varieties - 125 Pieces

Auveco Part No.	Description
5023	Ring Type, 22-18 Ga.
5026	Ring Type, 16-14 Ga.
5027	Ring Type, 16-14 Ga.
5028	Ring Type, 12-10 Ga.
5029	Ring Type, 12-10 Ga.
5031	Ring Type, 12-10 Ga.
5036	Spade Type, 16-14 Ga.
5047	Butt Conn., 22-18 Ga.
5048	Butt Conn., 16-14 Ga.
5049	Butt Conn., 12-10 Ga.
12144	Ring Type, 16-14 Ga.
17037	Butt Connector, 8 Ga.

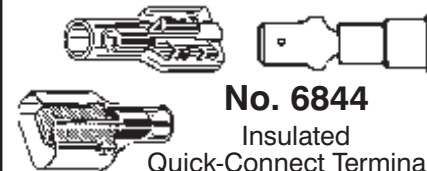

## No. 6844

Insulated  
Quick-Connect Terminals  
12 Varieties - 110 Pieces

Auveco Part No.	Description
5067	16-14 Ga., Male
5068	16-14 Ga., Female
11605	16-14 Ga., Male, Fully Insulated
11606	16-14 Ga., Female, Fully Insulated
11827	22-18 Ga., Female, Fully Insulated
11828	22-18 Ga., Male, Grip: 3/16"-1/4 Fully Insulated
11829	12-10 Ga., Female, Fully Insulated
11830	12-10 Ga., Male, Fully Insulated
12154	22-18 Ga., Male
12155	22-18 Ga., Female
12156	12-10 Ga., Male
12157	12-10 Ga., Female



## No. 6867

Wire Loom Routing Clips  
6 Varieties - 42 Pieces

Auveco Part No.	For Loom Size
14544	11/32" I.D., 1/2" O.D.
14545	13/32" I.D., 19/32" O.D.
14546	1/2" I.D., 11/16" O.D.
14547	3/4" I.D., 1" O.D.
16941	1" I.D., 1-9/32" O.D.
19440	1/4" I.D., 3/8" O.D.



## No. 6821

Glass Shop Rivets  
6 Varieties-63 Pieces

Auveco Part No.	Size
11620	1/4" Dia. Grip: 1/32"-9/64"
11621	1/4" Dia. Grip: 33/64"-19/32"
11852	1/4" Dia. Grip: 5/64"-7/64"
12653	1/4" Dia. Grip: 3/32"-1/8"
12655	1/4" Dia. Grip: 9/64"-3/16"
16834	1/8" Dia. Grip: 1/8"-3/16"

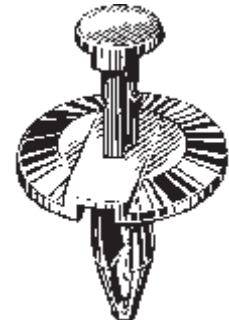

## No. 6805

Ford Push-Type Retainers  
6 Varieties-71 Pieces

Contains the following Auveco part numbers: 11705, 14018, 14019, 14020, 14753 & 14953.



## No. 6840

Pan'l Blind Rivets  
12 Varieties - 291 Pieces

Auveco Part No.	Size
<b>1/8 Diameter</b>	
8309	Grip: 1/16"-1/8"; Alum./Alum.
5753	Grip: 3/16"-1/4"; Steel/Steel
8925	Grip: 3/16"-1/4"; Alum./Alum.
8931	Grip: 3/16"-1/4"; Lg. Flange; Alum./Alum.
8880	Grip: 5/16"-3/8"; Steel/Steel
16031	Grip: 5/16"-3/8"; Alum./Alum.
16032	Grip: 3/8"-1/2"; Alum./Alum.
<b>3/16" Diameter</b>	
5755	Grip: 1/16"-1/8"; Alum./Alum.
8311	Grip: 1/8"-1/4"; Alum./Alum.
8301	Grip: 1/4"-3/8"; Alum./Alum.
8313	Grip: 1/4"-3/8"; Lg. Flange; Alum./Alum.
8938	Grip: 3/8"-1/2"; Alum./Alum.

**Sec. 15**

**"6800" SERIES QUIK-SELECT ASSORTMENTS**

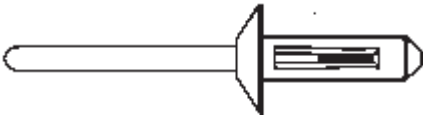

**No. 6806**  
Nylon Rivets  
12 Varieties-74 Pieces

Auveco Part No.	Size
15187	4mm Dia., Rectangular Head
13747	13/64" Dia., Grip: 1/16"-11/64"
13748	13/64" Dia., Grip: 1/8"-15/64"
13755	13/64" Dia., Grip: 15/64"-25/64"
14004	15/64" Dia., Grip: 11/64"-11/32"
14023	15/64" Dia., Grip: 5/32"-5/16"
13749	1/4" Dia., Grip: 5/32"-15/64"
13750	1/4" Dia., Grip: 5/32"-13/32"
13751	1/4" Dia., Grip: 5/32"-13/32"
17101	1/4" Dia., Grip: 5/16"-15/32"
13752	17/64" Dia., Grip: 3/32"-3/16"
13753	17/64" Dia., Grip: 3/32"-3/16"



**No. 6841**  
Specialty Rivets  
12 Varieties - 72 Pieces

Auveco Part No.	Size
<b>1/8" Diameter</b>	
16834	Grip: 1/8"-3/16"
11104	Grip: 3/16"-1/4"
<b>3/16" Diameter</b>	
16864	Grip: 3/64"-11/32"
17121	Grip: 5/64"-15/64"
14127	Grip: 3/8"-1/2"
<b>1/4" Diameter</b>	
11620	Grip: 1/32"-9/64"; "Peel-Type"
12653	Grip: 3/32"-1/8"; "Peel-Type"
18167	Grip: 3/32"-9/64"; "Peel-Type"
12652	Grip: 1/8"-1/4"
12655	Grip: 9/64"-3/16"; "Peel-Type"
17639	Grip: 3/16"-3/8"
11621	Grip: 33/64"-19/32"; "Peel-Type"



**No. 6804**  
GM Push-type Retainers  
12 Varieties-76 Pieces

Contains the following Auveco part numbers: **11699, 12567, 12757, 13993, 14010, 14011, 14020, 14753, 15044, 15045, 17216 & 18353.**



**No. 6809**  
Window Reveal Moulding Clips  
GM & Ford  
12 Varieties-132 Pieces

Contains the following Auveco part numbers: **8583, 8941, 9633, 9639, 9882, 10243, 10630, 10631, 11067, 11152, 11345 & 13564.**

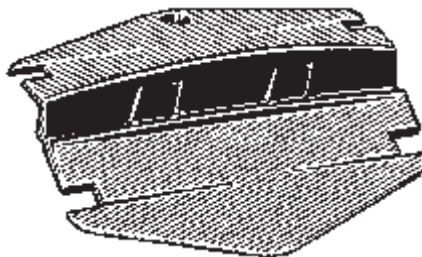

**No. 6822**  
GM Window Guides  
6 Varieties-30 Pieces

Auveco Part No.	O.E.M. No.
15462	20478733
15463	20487630, 20712176
15466	20160591
15467	20123070, 20328600
17159	20747509
17176	20162174, 22543363

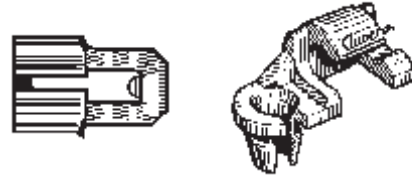

**No. 6864**  
Door Lock Rod Clips  
12 Varieties - 59 Pieces

Contains the following Auveco part numbers: **10262, 14359, 14365, 14967, 15518, 15673, 15674, 15675, 15759, 17069, 17122 & 18926.**



**No. 6820**

Oil Drain Plug Gaskets  
12 Varieties-120 Pieces

Auveco Part No.	Size	
8277	1/2"	Nylon
8278	5/8"	Nylon
8279	3/4"	Nylon
8281	9/16"	Nylon
15918	1/2"	Copper
15919	9/16"	Copper
16680	12mm	Nylon
16681	14mm	Nylon
16682	14mm	Fibre
16683	16.5mm	Nylon
16684	18mm	Nylon
16685	20mm	Nylon



**No. 6825**

Oil Drain Plug Gaskets  
12 Varieties - 108 Pieces

Auveco Part No.	Size	
8277	1/2"	Nylon
8278	5/8"	Nylon
8279	3/4"	Nylon
8281	9/16"	Nylon
15918	1/2"	Copper
15919	9/16"	Copper
16026	1/2"	Steel & Rubber
16680	12mm	Nylon
16681	14mm	Nylon
16956	14mm	Aluminum
16996	1/2"	Nylon
17628	12mm	Fibre

# "6800" SERIES QUIK-SELECT ASSORTMENTS

**Sec. 15**



## No. 6826

Rubber Vacuum Caps  
6 Varieties - 121 Pieces

Auveco Part No.	Size
12209	Fits 1/8" O.D. Tube
4440	Fits 3/16" O.D. Tube
4439	Fits 1/4" O.D. Tube
12907	Fits 5/16" O.D. Tube
12210	Fits 3/8" O.D. Tube
12908	Fits 1/2" O.D. Tube



## No. 6827

Rubber Grommets  
18 Varieties - 99 Pieces

Auveco Part No.	Size
4408	1/8" Bore Dia, 3/32" Width
4410	5/32" Bore Dia, 1/16" Width
4413	3/16" Bore Dia, 1/16" Width
4414	3/16" Bore Dia, 3/32" Width
4415	3/16" Bore Dia, 1/4" Width
4417	1/4" Bore Dia, 1/16" Width
4419	5/16" Bore Dia, 1/16" Width
4421	5/16" Bore Dia, 1/8" Width
4422	5/16" Bore Dia, 1/4" Width
4423	3/8" Bore Dia, 1/16" Width
4425	3/8" Bore Dia, 1/16" Width
4426	3/8" Bore Dia, 1/4" Width
4428	1/2" Bore Dia, 3/32" Width
4430	1/2" Bore Dia, 1/4" Width
4431	5/8" Bore Dia, 1/8" Width
4432	5/8" Bore Dia, 1/16" Width
4434	3/4" Bore Dia, 1/16" Width
4436	3/4" Bore Dia, 1/4" Width



## No. 6831

Plastic Plug Buttons  
6 Varieties - 305 Pieces

Auveco Part No.	Size
<b>Depressed Center Type</b>	
9288	1/2" Hole Size
9289	3/4" Hole Size
<b>Flush Type</b>	
14923	3/8" Hole Size
11746	1/2" Hole Size
11747	3/4" Hole Size
11749	1" Hole Size



## No. 6835

Rubber "O" Rings  
Buna "N"  
18 Varieties - 770 Pieces

Auveco Part No.	Ind. Std.	I.D.	O.D.
4305	006	1/8"	1/4"
4306	007	5/32"	9/32"
4307	008	3/16"	5/16"
4308	009	7/32"	11/32"
4309	010	1/4"	3/8"
4310	011	5/16"	7/16"
4311	012	3/8"	1/2"
4312	110	3/8"	9/16"
4313	111	7/16"	5/8"
4314	112	1/2"	11/16"
4315	113	9/16"	3/4"
4316	114	5/8"	13/16"
4317	115	11/16"	7/8"
4318	116	3/4"	15/16"
4319	210	3/4"	1"
4320	211	13/16"	1-1/16"
4321	212	7/8"	1-1/8"
4323	214	1"	1-1/4"



## No. 6860

Rubber "O" Rings  
Buna "N"  
12 Varieties - 143 Pieces

Auveco Part No.	Ind. Std.	I.D.	O.D.
4320	211	13/16"	1-1/16"
4321	212	7/8"	1-1/8"
4322	213	15/16"	1-3/16"
4323	214	1"	1-1/4"
4324	215	1-1/16"	1-5/16"
4347	216	1-1/8"	1-3/8"
4348	217	1-3/16"	1-7/16"
4349	218	1-1/4"	1-1/2"
4350	219	1-5/16"	1-9/16"
4351	220	1-3/8"	1-5/8"
4352	221	1-7/16"	1-11/16"
4353	222	1-1/2"	1-3/4"

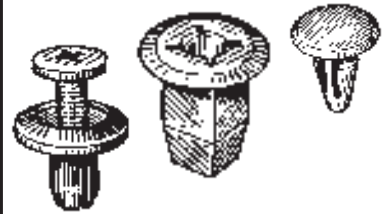

## No. 6829

Honda Body Hardware  
12 Varieties - 92 Pieces

Auveco Part No.	Description
13225	"U" Nut
14268	Screw Grommet
14274	Nylon Nut
14282	Retaining Clip
14313	Nylon Nut
14695	Screw Grommet
14696	Push-Type Retainer
14697	Push-Type Retainer
14698	Push-Type Retainer
16000	Push-Type Retainer
17143	Push-Type Retainer
17144	Push-Type Retainer

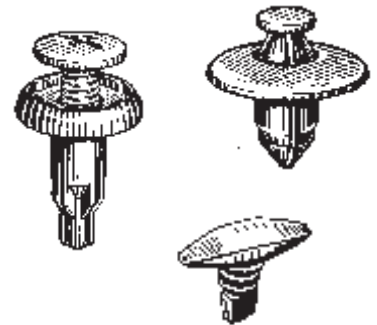

## No. 6837

Honda Body Hardware  
12 Varieties - 61 Pieces

Auveco Part No.	Description
14289	Panel Retainer
14291	Retaining Clip
14328	Weatherstrip Clip
16779	Retaining Clip
16782	Push-Type Retainer
17057	Push-Type Retainer
17081	Push-Type Retainer
17192	Push-Type Retainer
17205	Retaining Clip
17379	Push-Type Retainer
18114	Insulation Retainer
18119	Push-Type Retainer



## No. 6866

Rubber Bumpers  
12 Varieties - 105 Pieces

Auveco Part No.	Application
4155	General Purpose
4188	Door & Quarter Glass
4233	General Purpose
4235	Hood & Fender
4236	General Purpose
4237	General Purpose
4240	Door
4242	Hood, Trunk & Deck Lid
4244	General Purpose
4249	General Purpose
4250	Glove Box Door
4369	Pillar

**Sec. 15**

**"6800" SERIES QUIK-SELECT ASSORTMENTS**

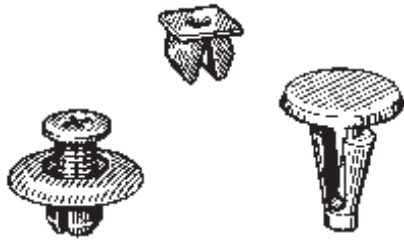

**No. 6833**

Nissan Body Hardware  
12 Varieties - 81 Pieces

Auveco Part No.	Description
13225	"U" Nut
13930	Nylon Nut
14275	Screw Grommet
14313	Nylon Nut
14695	Screw Grommet
14696	Push-Type Retainer
14737	Retaining Clip
16000	Push-Type Retainer
16784	Push-Type Retainer
16858	Push-Type Retainer
16859	Push-Type Retainer
17196	Grille Grommet



**No. 6838**

Nissan Body Hardware  
12 Varieties - 60 Pieces

Auveco Part No.	Description
14349	Retaining Clip
14352	Retaining Clip
14355	Retaining Clip
14356	Retaining Clip
16725	Push-Type Retainer
16775	Trim Panel Retainer
16776	Trim Panel Retainer
16782	Push-Type Retainer
16783	Push-Type Retainer
16843	Push-Type Retainer
17347	Push-Type Retainer
17472	Push-Type Retainer



**No. 6832**

Mazda Body Hardware  
12 Varieties - 88 Pieces

Auveco Part No.	Description
13225	"U" Nut
14255	Nylon Nut
14260	Push-Type Retainer
14269	Panel Retainer
14274	Nylon Nut
14313	Nylon Nut
14357	Screw Grommet
14369	Push-Type Retainer
14695	Screw Grommet
14697	Push-Type Retainer
14717	Windshield Clip
16000	Push-Type Retainer

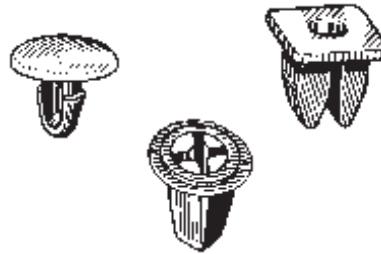

**No. 6834**

Toyota Body Hardware  
18 Varieties - 76 Pieces

Auveco Part No.	Description
13225	"U" Nut
13932	Nylon Nut
14256	Nylon Nut
14260	Push-Type Retainer
14265	Nylon Nut
14267	Screw Grommet
14268	Screw Grommet
14269	Panel Retainer
14274	Nylon Nut
14275	Screw Grommet
14276	Nylon "U" Nut
14695	Screw Grommet
14736	Retaining Clip
14737	Retaining Clip
14738	Retaining Clip
14750	Nylon "U" Nut
16306	Bumper Cushion Clip
16784	Push-Type Retainer

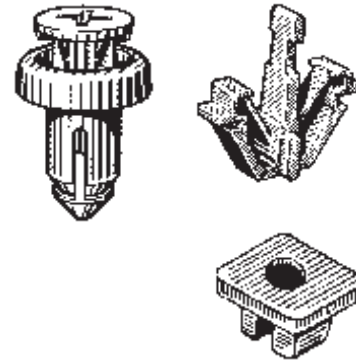

**No. 6839**

Toyota Body Hardware  
12 Varieties - 85 Pieces

Auveco Part No.	Description
14144	Trim Panel Retainer
14258	Nylon Nut
14271	Nylon Nut
14273	Screw Grommet
14732	Hood Prop Rod Clip
15695	Retainer
16779	Retaining Clip
16951	Headlight Spacer
17194	Grille Clip
17206	Push-Type Retainer
17438	Grille Clip
18297	Retaining Clip

Even though we offer over 375 assortments, we know you have some great ideas for additional ones. E-mail your new assortment suggestions to [mail@auveco.com](mailto:mail@auveco.com)

# ASSORTMENTS

**Sec. 15**

In Durable Translucent Polypropylene Boxes



**No. 19443**  
U.S. Grease Fittings  
Plated  
12 Varieties - 92 Pieces

Auveco Part No.	Type
9257	1/4"-28, Straight (Short)
9258	1/4"-28, Straight (Long)
9259	1/4"-28, Straight (X-Long)
9260	1/4"-28, 45 Degree
9261	1/4"-28, 90 Degree
9262	1/8" Pipe, Straight (Short)
9267	1/8" Pipe, Straight (Long)
15066	1/8" Pipe, Straight (Self-Tapping)
9264	1/8" Pipe, 45 Degree
9265	1/8" Pipe, 65 Degree
9266	1/8" Pipe, 90 Degree
15059	1/4" Pipe, Straight



**No. 19444**  
Metric Grease Fittings  
Plated  
12 Varieties - 86 Pieces

Auveco Part No.	Type
11097	6mm-1.00, Straight
11775	6mm-1.00, 45 Degree
11776	6mm-1.00, 90 Degree
11098	8mm-1.00, Straight
11777	8mm-1.00m 45 Degree
11099	8mm-1.00, 90 Degree
11778	8mm-1.25, Straight
11779	8mm-1.25, 45 Degree
11780	8mm-1.25, 90 Degree
11100	10mm-1.00, Straight
15067	10mm-1.00, 45 Degree
11101	10mm-1.00, 90 Degree



**No. 19442**  
Extension Springs  
Zinc Plated  
6 Varieties - 38 Pieces

Contains the following  
Auveco part numbers:  
**14063, 14064, 14065**  
**14066, 14069 & 14074**



**No. 19445**  
GM O.E.M. Electrical Terminals  
12 Varieties - 223 Pieces

Contains the following  
Auveco part numbers:  
**8774, 8776, 14150, 14151,**  
**14152, 14880, 14881,**  
**14883, 15497, 15498,**  
**15937 & 15948.**

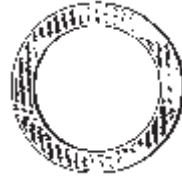

**No. 19927**  
Copper Washers  
6 Varieties - 150 Pieces

Auveco Part No.	Dimensions
15915	1/4" Bolt Size, 11/16" O.D.
15913	5/16" Bolt Size, 9/16" O.D.
15916	5/16" Bolt Size, 3/4" O.D.
15917	3/8" Bolt Size, 13/16" O.D.
15918	7/16" Bolt Size, 7/8" O.D.
15919	1/2" Bolt Size, 13/16" O.D.

**Visit The Auveco Web Site**  
**At [www.auveco.com](http://www.auveco.com)**  
**For The Latest Information**  
**On New Items.**

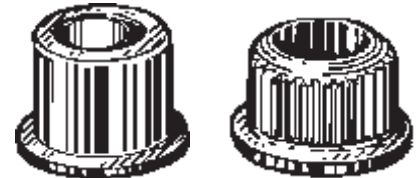

**No. 17359**  
Door Hinge Bushings  
8 Varieties - 136 Pieces

Auveco Part No.	Application
14548	GM
14549	GM
14550	GM, Ford
14551	Ford
14553	GM
16936	GM
16937	GM

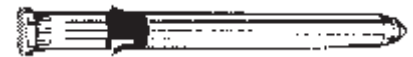

**No. 17358**  
Door Hinge Pins  
6 Varieties - 35 Pieces

Auveco Part No.	Application
14559	GM
14561	Chrysler
14562	Chrysler
17437	GM
19183	GM
19424	GM

# Sec. 15

# "FP" 4 PACK ASSORTMENTS

The Auveco "FP" 4 Pack assortment is packed in a four compartment easy open translucent polypropylene box. Each assortment contains four carefully selected items designed for the customer that requires maximum coverage for a minimum investment.



Auveco Part No.	Description	Auveco Part No.	Description
<b>FP-100</b>	Phillips Oval Head Tapping Screws, Chrome	<b>FP-188</b>	Plug Buttons
<b>FP-102</b>	Phillips Oval Head Tapping Screws, Chrome	<b>FP-190</b>	Retainer Pins
<b>FP-103</b>	Phillips Oval Head Tapping Screws, Zinc	<b>FP-193</b>	Grease Fittings
<b>FP-104</b>	Phillips Oval Head Tapping Screws, Chrome	<b>FP-194</b>	Grease Fittings
<b>FP-105</b>	Phillips Oval Head Tapping Screws, Zinc	<b>FP-206</b>	Window Reveal Moulding Clips
<b>FP-108</b>	Phillips Oval Head Tapping Screws, Chrome	<b>FP-210</b>	Universal Moulding Fasteners
<b>FP-111</b>	Phillips Oval Head Tapping Screws, S. Steel	<b>FP-224</b>	Phillips Oval Head Tapping Screws, B. Oxide
<b>FP-112</b>	Phillips Oval Head Tapping Screws, S. Steel	<b>FP-225</b>	Phillips Oval Head Tapping Screws, B. Oxide
<b>FP-113</b>	Phillips Oval Head Tapping Screws, S. Steel	<b>FP-226</b>	Phillips Pan Head Tapping Screws, B. Oxide
<b>FP-119</b>	Phillips Pan Head Tapping Screws, Zinc	<b>FP-228</b>	Phillips Oval Head Sems® Teks® Screws, Chrome
<b>FP-120</b>	Phillips Pan Head Tapping Screws, Zinc	<b>FP-229</b>	Phillips Oval Head Sems® Teks® Screws, Phos.
<b>FP-121</b>	Phillips Pan Head Tapping Screws, Zinc	<b>FP-231</b>	Phillips Oval Head Sems® Screws, Phos
<b>FP-123</b>	Phillips Oval Head Sems® Screws, Chrome	<b>FP-232</b>	Phillips Oval Head Sems® Screws, Phos
<b>FP-130</b>	Slotted Hex Washer Head Tapping Screws	<b>FP-233</b>	Phillips Flat Washer Head Tapping Screws, Black E-Coat
<b>FP-131</b>	Hex Washer Head Tapping Screws	<b>FP-234</b>	Phillips Flat Washer Head Tapping Screws Black E-Coat
<b>FP-132</b>	Hex Washer Head Tapping Screws	<b>FP-235</b>	Type "F" Thread Cutting Screws
<b>FP-141</b>	Slotted Round Hd. Machine Screws & Nuts	<b>FP-236</b>	Teks® Hex Washer Head Tapping Screws
<b>FP-159</b>	Washer Lock Nuts	<b>FP-237</b>	Metric License Plate Screws
<b>FP-160</b>	Thread Cutting Nuts	<b>FP-238</b>	Metric Free Spinning Washer Nuts
<b>FP-163</b>	Tubular Nuts	<b>FP-239</b>	U.S.S. Free Spinning Washer Nuts
<b>FP-164</b>	Tubular Nuts	<b>FP-241</b>	Metric Pushnut Bolt Retainers
<b>FP-165</b>	Flat Nuts	<b>FP-243</b>	Push-On Retainers
<b>FP-166</b>	Flat Nuts	<b>FP-244</b>	Rubber Nut Inserts
<b>FP-168</b>	"J" & "U" Nuts	<b>FP-245</b>	Metric Extruded "U" Nuts
<b>FP-169</b>	"J" Type Cage Nuts	<b>FP-247</b>	Spring Type "U" Nuts
<b>FP-171</b>	Flat Washers		
<b>FP-174</b>	Finishing Washers		
<b>FP-177</b>	Oil Drain Plug Nylon Gaskets		
<b>FP-178</b>	Shims		
<b>FP-179</b>	Shims		
<b>FP-183</b>	Cotter Pins		
<b>FP-184</b>	Cotter Pins		
<b>FP-185</b>	Cotter Pins		



**FP-100**  
Phillips Oval Head Tapping Screws  
Chrome  
150 Pieces

Auveco Part No.	Size
<b>1794</b>	6 x 3/4"
<b>2698</b>	6 x 1/2"
<b>1796</b>	6 x 1"
<b>1797</b>	6 x 1-1/4"



**FP-102**  
Phillips Oval Head Tapping Screws  
Chrome  
140 Pieces

Auveco Part No.	Size
<b>2707</b>	8 x 1/2"
<b>2710</b>	8 x 3/4"
<b>2713</b>	8 x 1"
<b>2716</b>	8 x 1-1/4"



# "FP" 4 PACK ASSORTMENTS



**FP-104**  
Phillips Oval Head Tapping Screws  
No. 6 Head - Chrome  
130 Pieces

Auveco Part No.	Size
<b>2027</b>	8 x 1/2"
<b>1799</b>	8 x 3/4"
<b>1483</b>	8 x 1"
<b>1423</b>	8 x 1-1/4"



**FP-224**  
Phillips Oval Head Tapping Screws  
Black Oxide  
245 Pieces

Auveco Part No.	Size
<b>10163</b>	8 x 1/2"
<b>10165</b>	8 x 3/4"
<b>10167</b>	8 x 1"
<b>10169</b>	8 x 1-1/4"



**FP-113**  
Phillips Oval Head Tapping Screws  
Stainless Steel  
95 Pieces

Auveco Part No.	Size
<b>9400</b>	6 x 3/4"
<b>9405</b>	8 x 1"
<b>9410</b>	10 x 1"
<b>9412</b>	10 x 1-1/2"



**FP-108**  
Phillips Oval Head Tapping Screws  
No. 8 Head - Chrome  
115 Pieces

Auveco Part No.	Size
<b>2724</b>	10 x 5/8"
<b>1717</b>	10 x 3/4"
<b>2730</b>	10 x 1"
<b>2734</b>	10 x 1-1/4"



**FP-225**  
Phillips Oval Head Tapping Screws  
No. 6 Head - Black Oxide  
250 Pieces

Auveco Part No.	Size
<b>10164</b>	8 x 3/4"
<b>10166</b>	8 x 1"
<b>10168</b>	8 x 1-1/4"
<b>10170</b>	8 x 1-1/2"



**FP-119**  
Phillips Pan Head Tapping Screws  
Zinc  
220 Pieces

Auveco Part No.	Size
<b>1939</b>	8 x 3/8"
<b>1940</b>	8 x 1/2"
<b>2365</b>	8 x 3/4"
<b>3079</b>	8 x 1"



**FP-103**  
Phillips Oval Head Tapping Screws  
Zinc  
160 Pieces

Auveco Part No.	Size
<b>2358</b>	8 x 1/2"
<b>2359</b>	8 x 3/4"
<b>2360</b>	8 x 1"
<b>2361</b>	8 x 1-1/4"



**FP-111**  
Phillips Oval Head Tapping Screws  
Stainless Steel  
110 Pieces

Auveco Part No.	Size
<b>9403</b>	8 x 1/2"
<b>9404</b>	8 x 3/4"
<b>9405</b>	8 x 1"
<b>9406</b>	8 x 1-1/4"



**FP-121**  
Phillips Pan Head Tapping Screws  
Zinc  
200 Pieces

Auveco Part No.	Size
<b>1937</b>	6 x 1/2"
<b>1940</b>	8 x 1/2"
<b>1943</b>	10 x 1/2"
<b>2367</b>	12 x 3/4"



**FP-105**  
Phillips Oval Head Tapping Screws  
No. 6 Head - Zinc  
170 Pieces

Auveco Part No.	Size
<b>2706</b>	8 x 1/2"
<b>1798</b>	8 x 3/4"
<b>1801</b>	8 x 1"
<b>1803</b>	8 x 1-1/4"



**FP-112**  
Phillips Oval Head Tapping Screws  
Stainless Steel  
90 Pieces

Auveco Part No.	Size
<b>9408</b>	10 x 1/2"
<b>9409</b>	10 x 3/4"
<b>9410</b>	10 x 1"
<b>9411</b>	10 x 1-1/4"



**FP-120**  
Phillips Pan Head Tapping Screws  
Zinc  
145 Pieces

Auveco Part No.	Size
<b>1943</b>	10 x 1/2"
<b>2366</b>	10 x 3/4"
<b>3082</b>	10 x 1"
<b>3083</b>	10 x 1-1/4"

**Sec. 15**

**"FP" 4 PACK ASSORTMENTS**



**FP-226**

Phillips Pan Head Tapping Screws  
Black Oxide  
275 Pieces

Auveco Part No.	Size
10180	8 x 1/2"
10181	8 x 3/4"
10182	8 x 1"
10183	8 x 1-1/4"



**FP-123**

Phillips Oval Head Sems®  
Tapping Screws  
Chrome  
90 Pieces

Auveco Part No.	Size
2771	8 x 5/8"
2751	8 x 3/4"
2772	8 x 1"
3466	10 x 3/4"



**FP-231**

Phillips Oval Head Sems®  
Tapping Screws  
Black Phosphate  
110 Pieces

Auveco Part No.	Size
11787	8 x 5/8"
11788	8 x 3/4"
11789	8 x 1"
11790	8 x 1-1/4"



**FP-232**

Phillips Oval Head Sems  
Tapping Screws  
Black Phosphate  
100 Pieces

Auveco Part No.	Size
11788	8 x 3/4"
11789	8 x 1"
11791	10 x 3/4"
11792	10 x 1"



**FP-229**

Phillips Oval Head Sems®  
With No. 2 Drill Points  
Tapping Screws  
Phosphate  
70 Pieces

Auveco Part No.	Size
11454	8 x 5/8"
11455	8 x 3/4"
11456	8 x 1"
11457	8 x 1-1/4"



**FP-228**

Phillips Oval Head Sems®  
With No. 2 Drill Head  
Tapping Screws  
Chrome  
50 Pieces

Auveco Part No.	Size
11449	8 x 5/8"
11450	8 x 3/4"
11451	8 x 1"
11452	8 x 1-1/4"



**FP-233**

Phillips Flat Washer Hd.  
Tapping Screws  
Black E-Coat  
220 Pieces

Auveco Part No.	Size
12213	8 x 1/2"
12214	8 x 5/8"
12215	8 x 3/4"
12216	8 x 1"



**FP-234**

Phillips Flat Top  
Washer Head Tapping Screws  
Black E-Coat  
110 Pieces

Auveco Part No.	Size
12950	6 x 1/2"
12953	10 x 3/4"
12954	10 x 1"
12955	10 x 1-1/4"



**FP-235**

Hex Washer Head  
Type "F"  
Thread Cutting Screws  
Zinc  
45 Pieces

Auveco Part No.	Size
5784	1/4"-20 x 3/4"
5786	1/4"-20 x 1"
8442	5/16"-18 x 3/4"
8443	5/16"-18 x 1"



**FP-236**

Teks® Self-Drilling  
Hex Washer Head Tapping Screws  
Zinc  
90 Pieces

Auveco Part No.	Size
9612	8 x 3/4"
9615	10 x 3/4"
9616	10 x 1"
11914	14 x 1"



**FP-130**

Slotted Hex  
Washer Head  
Tapping Screws  
Zinc  
190 Pieces

Auveco Part No.	Size
3374	8 x 1/2"
3376	8 x 3/4"
3381	10 x 1/2"
3383	10 x 3/4"

# "FP" 4 PACK ASSORTMENTS



**FP-131**  
Hex Washer Head  
Tapping Screws  
Zinc  
165 Pieces

Auveco Part No.	Size
<b>2369</b>	10 x 1/2"
<b>2809</b>	10 x 5/8"
<b>3474</b>	12 x 1/2"
<b>2968</b>	12 x 3/4"



**FP-132**  
Hex Washer Head  
Tapping Screws  
Zinc  
75 Pieces

Auveco Part No.	Size
<b>2370</b>	14 x 5/8"
<b>2330</b>	14 x 3/4"
<b>2974</b>	14 x 1"
<b>2978</b>	5/16" x 3/4"



**FP-237**  
Metric License Plate Screws  
80 Pieces

Auveco Part No.	Size
<b>14473</b>	M6-1.0 x 16mm, Zinc
<b>15878</b>	M6-1.0 x 16mm, B. E-Coat
<b>17152</b>	M6-1.0 x 16mm, B. E-Coat



**FP-141**  
Slotted Round Head  
Machine Screws With Hex Nuts  
Zinc  
200 Pieces

Auveco Part No.	Size
<b>3711</b>	3/16" x 1/2"
<b>3712</b>	3/16" x 3/4"
<b>3713</b>	3/16" x 1"
<b>3720</b>	1/4" x 1"



**FP-238**  
Metric Free Spinning  
Washer Nuts  
Phosphate  
48 Pieces

Auveco Part No.	Size
<b>12595</b>	M6-1.0, 16mm O.D.
<b>15329</b>	M6-1.0, 18mm O.D.
<b>15331</b>	M6-1.0, 20mm O.D.
<b>15335</b>	M8-1.25, 24mm O.D.



**FP-239**  
U.S.S. Free Spinning  
Washer Nuts  
41 Pieces

Auveco Part No.	Size
<b>15342</b>	10-24, 9/16" O.D.
<b>15345</b>	1/4"-20, 5/8" O.D.
<b>15347</b>	1/4"-20, 3/4" O.D.
<b>15350</b>	5/16"-18, 3/4" O.D.

You Can E-mail  
Your New Item  
Suggestions To  
[mail@auveco.com](mailto:mail@auveco.com)



**FP-241**  
Metric Pushnut  
Bolt Retainers  
115 Pieces

Auveco Part No.	Size
<b>12123</b>	M6-1.0, 12.7mm O.D.
<b>12259</b>	M8-1.25, 24mm O.D.
<b>12260</b>	M10-1.5, 24mm O.D.
<b>12127</b>	M12-1.75, 21.4mm O.D.



**FP-243**  
Push-On Retainers  
Zinc  
260 Pieces

Auveco Part No.	Size
<b>8863</b>	1/8" Stud, 3/8" O.D.
<b>8865</b>	3/16" Stud, 7/16" O.D.
<b>8868</b>	1/4" Stud, 17/32" O.D.
<b>8869</b>	5/16" Stud, 5/8" O.D.



**FP-159**  
Washer Lock Nuts  
Zinc  
240 Pieces

Auveco Part No.	THD.	O.D.
<b>2555</b>	8-32	15/32"
<b>2557</b>	10-24	1/2"
<b>2558</b>	10-24	3/4"
<b>2560</b>	12-24	3/4"

**Sec. 15**

**"FP" 4 PACK ASSORTMENTS**



**FP-160**

Thread Cutting Nuts  
Zinc  
125 Pieces

Auveco Part No.	Stud Size	O.D.
3403	1/8"	7/16"
2895	1/8"	17/32"
2896	3/16"	5/8"
2897	1/4"	19/32"



**FP-168**

"J" And "U" Type Nuts  
48 Pieces

Auveco Part No.	Screw Size
1907	5/16"
2057	No.14
2420	No.14
2293	1/4"-20



**FP-245**

Metric Extruded "U" Nuts  
Phosphate  
34 Pieces

Auveco Part No.	Size
12669	M6-1.0, Short
12575	M6-1.0, Long
11629	M8-1.25, Short
11630	M8-1.25, Long



**FP-244**

Rubber Nut Inserts  
39 Pieces

Auveco Part No.	Size
19912	8-32, .015" - .156"
19913	10-32, .311" - .630"
19915	1/4"-20, .015" - .110"
19916	1/4"-20, .032" - .185"



**FP-169**

"J" Type Cage Nuts  
28 Pieces

Auveco Part No.	Thread Size
5589	5/16"-18
5170	3/8"-16
5586	1/4"-20



**FP-247**

Spring Type "U" Nuts  
Phosphate  
70 Pieces

Auveco Part No.	Size
10064	#6 Screw Size
10065	#8 Screw Size
10066	#10 Screw Size
10067	#14 Screw Size



**FP-165**

Flat Nuts  
240 Pieces

Auveco Part No.	Stud Size
2098	1/16"
2100	3/32"
2099	1/8"
2102	5/32"



**FP-163**

Tubular Nuts  
80 Pieces

Auveco Part No.	Stud Size
3136	1/16"
2611	1/8"
3776	3/32"
2565	3/16"



**FP-171**

Fender Washers  
Zinc Plated  
200 Pieces

Auveco Part No.	Bolt Size	O.D.
1183	3/16"	3/4"
2333	1/4"	1-1/4"
768	5/16"	1-1/4"
3553	3/8"	1-1/4"



**FP-166**

Flat Nuts  
140 Pieces

Auveco Part No.	Size
2092	10-24 Screw
2103	3/16" Stud
1903	1/4"-20 Screw
2105	1/4" Stud



**FP-164**

Tubular Nuts  
75 Pieces

Auveco Part No.	Stud Size
2595	1/8"
3137	3/32"
10073	3/16"
5196	1/4"



The World's Largest  
Selection Of Body  
Hardware & Specialty  
Fasteners

# "FP" 4 PACK ASSORTMENTS

**Sec. 15**



**FP-174**  
Flanged & Flush  
Countersunk Washers  
Nickel On Brass  
160 Pieces

Auveco Part No.	Screw Size	Type
3469	No.6	Flanged
2515	No.8	Flanged
602	No.6	C/S
604	No.8	C/S



**FP-206**  
Window Reveal  
Moulding Fasteners  
Ford & GM  
75 Pieces

Consists of the following  
Auveco Part Numbers: **8583,**  
**8396, 8941, 9882**



**FP-210**  
Universal Moulding  
Fasteners - With Nuts  
36 Pieces

Consists of the following  
Auveco Part Numbers: **2818,**  
**2619, 2752, 19626.**

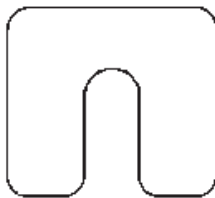

**FP-178**  
Shims - Plated  
75 Pieces

Auveco Part No.	Size	Thick	Slot
3155	1-1/4" x 1-1/8"	1/16"	3/8"
3156	1-1/4" x 1-1/8"	1/8"	3/8"
2452	1-3/4" x 1-1/4"	1/16"	1/2"
2453	1-3/4" x 1-1/4"	1/8"	1/2"



**FP-179**  
Caster &  
Camber  
Shims-plated  
65 Pieces

Auveco Part No.	Thick	Size
5075	1/32"	1/8" x 1"
5077	1/8"	1/8" x 1"
5090	1/16"	1-3/8" x 1"
5094	1/16"	1-5/8" x 1"



**FP-184**  
Hammer Lock  
Cotter Pins  
Plated  
600 Pieces

Auveco Part No.	Size
8477	1/16" x 1/2"
8478	1/16" x 3/4"
8479	1/16" x 1"
8483	3/32" x 1-1/4"



**FP-183**  
Hammer Lock  
Cotter Pins  
Plated  
240 Pieces

Auveco Part No.	Size
8482	3/32" x 1"
8484	3/32" x 1-1/2"
8488	1/8" x 1-1/2"
8490	1/8" x 2"



**FP-185**  
Hammer Lock  
Cotter Pins  
Plated  
125 Pieces

Auveco Part No.	Size
8492	5/32" x 1"
8493	5/32" x 1-1/2"
8495	3/16" x 1-1/2"
8496	3/16" x 2"



**FP-190**  
Retainers  
Pins  
220 Pieces

Auveco Part No.	I.D.	Length
9113	1/8"	1/2"
9112	1/8"	1-1/8"
9111	5/32"	7/8"
9110	3/16"	1-3/16"



**FP-188**  
Plug Buttons  
Nickel Plated  
44 Pieces

Auveco Part No.	Hole Size
3750	1/4"
3751	3/8"
3752	1/2"
3753	5/8"



**FP-177**  
Oil Drain Plug  
Gaskets  
Nylon  
75 Pieces

Auveco Part No.	I.D.	O.D.
8277	1/2"	3/4"
8278	5/8"	1"
8280	7/8"	1-1/8"
8281	9/16"	13/16"



**FP-193**  
Ball Check  
Grease Fittings  
34 Pieces

Auveco Part No.	Size
9257	1/4"-28 Short
9258	1/4"-28 Long
9259	1/4"-28 Extra Long
9262	1/8" Pipe Thread



**FP-194**  
Ball Check  
Grease Fittings  
22 Pieces

Auveco Part No.	Size
9260	1/4"-28, 45°
9261	1/4"-28, 90°
9264	1/8" Pipe, 45°
9265	1/8" Pipe, 65°

**15961**

Metric Buna "N" Rubber  
"O" Rings  
36 Varieties - 500 Pieces

Auveco Part No.	I.D.	O.D.
16647	2.2mm	5.4mm
16648	3.1mm	6.3mm
15764	4mm	8mm
16649	4.1mm	7.3mm
16651	4.3mm	9.1mm
16650	5mm	8mm
16642	5.3mm	10.1mm
16644	5.6mm	10.4mm
15765	6mm	10mm
16643	7.1mm	10.3mm
16646	7.6mm	12.4mm
16645	8mm	12mm
16638	8.3mm	13.1mm
16640	8.6mm	13.4mm
15766	9mm	13mm
16633	9mm	15mm
16637	9.1mm	12.3mm
16641	10mm	14mm
15767	10mm	15mm
16634	10mm	16mm
16639	10.1mm	13.3mm
16636	11mm	17mm
15768	12mm	16mm
16635	13mm	16mm
15769	13mm	18mm
16628	13.1mm	16.3mm
16629	14mm	18mm
16630	14mm	19mm
16632	15mm	20mm
16631	16mm	19mm
15770	16mm	20mm
16626	17mm	22mm
16627	18mm	23mm
15771	19mm	23mm
15772	19mm	24mm
15773	20mm	24mm



**18885**

Air Conditioning Nitrile "O" Rings  
For use with R134A  
& R12 refrigerant  
17 Varieties - 196 Pieces

Auveco Part No.	I.D.	O.D.	Thick-ness
17604	.290"	.432"	.071"
18646	3/8"	1/2"	1/16"
17605	.400"	.546"	.073"
17606	.509"	.655"	.073"
17607	.617"	.769"	.076"
18647	11/16"	13/16"	1/16"
18134	4.5mm	7.3mm	1.4mm
18135	6mm	9.6mm	1.8mm
18136	6.5mm	9.5mm	1.5mm
18137	6.6mm	10.2mm	1.8mm
18138	7.7mm	11.3mm	1.8mm
18140	10.7mm	15.5mm	2.4mm
18139	10.8mm	14.4mm	1.8mm
18141	13.3mm	18.1mm	2.4mm
18143	13.4mm	17.2mm	1.9mm
18142	14mm	17.6mm	1.8mm
18144	14.8mm	19.6mm	2.4mm

**16732**

Air Conditioning  
Neoprene "O" Rings  
For original air conditioning  
systems with R12. Not for use  
with R134A refrigerant  
16 Varieties - 367 Pieces

Auveco Part No.	Ind. Std.	I.D.	O.D.	Thick-ness
16324	010	1/4"	3/8"	1/16"
16325	011	5/16"	7/16"	1/16"
16326	012	3/8"	1/2"	1/16"
16327	013	7/16"	9/16"	1/16"
16328	014	1/2"	5/8"	1/16"
16329	112	1/2"	11/16"	3/32"
16330	015	9/16"	11/16"	1/16"
16331	113	9/16"	3/4"	3/32"
16332	016	5/8"	3/4"	1/16"
16333	017	11/16"	13/16"	1/16"
16334	018	3/4"	7/8"	1/16"
16335	211	13/16"	1-1/16"	1/8"
16336	118	7/8"	1-1/16"	3/32"
16337	119	15/16"	1-1/8"	3/32"
16338	123	1-3/16"	1-3/8"	3/32"
16339	124	1-1/4"	1-7/16"	3/32"

**18886**

Air Conditioning  
Blue Neoprene (Teflon Coated)  
"O" Rings  
For use with R134A  
& R12 refrigerant  
11 Varieties - 300 Pieces

Auveco Part No.	Ind. Std.	I.D.	O.D.	Thick-ness
18533	108	1/4"	7/16"	3/32"
18534	011	5/16"	7/16"	1/16"
18535	012	3/8"	1/2"	1/16"
18536	110	3/8"	9/16"	3/32"
18537	013	7/16"	9/16"	1/16"
18538	014	1/2"	5/8"	1/16"
18539	112	1/2"	11/16"	3/32"
18540	015	9/16"	11/16"	1/16"
18541	113	9/16"	3/4"	3/32"
18542	016	5/8"	3/4"	1/16"
18543	017	11/16"	13/16"	1/16"



**12976**

"O" RING SPLICING KIT

**Replacement Rubber Cord**  
For 12976 Kit  
Buna Compound 47150

Auveco Part No.	Unit Pkg.	Diameter	Lgth.
14124	2	.275" (17/64")	7 ft.

# BUNA "N" RUBBER "O" RINGS

**Sec. 16**

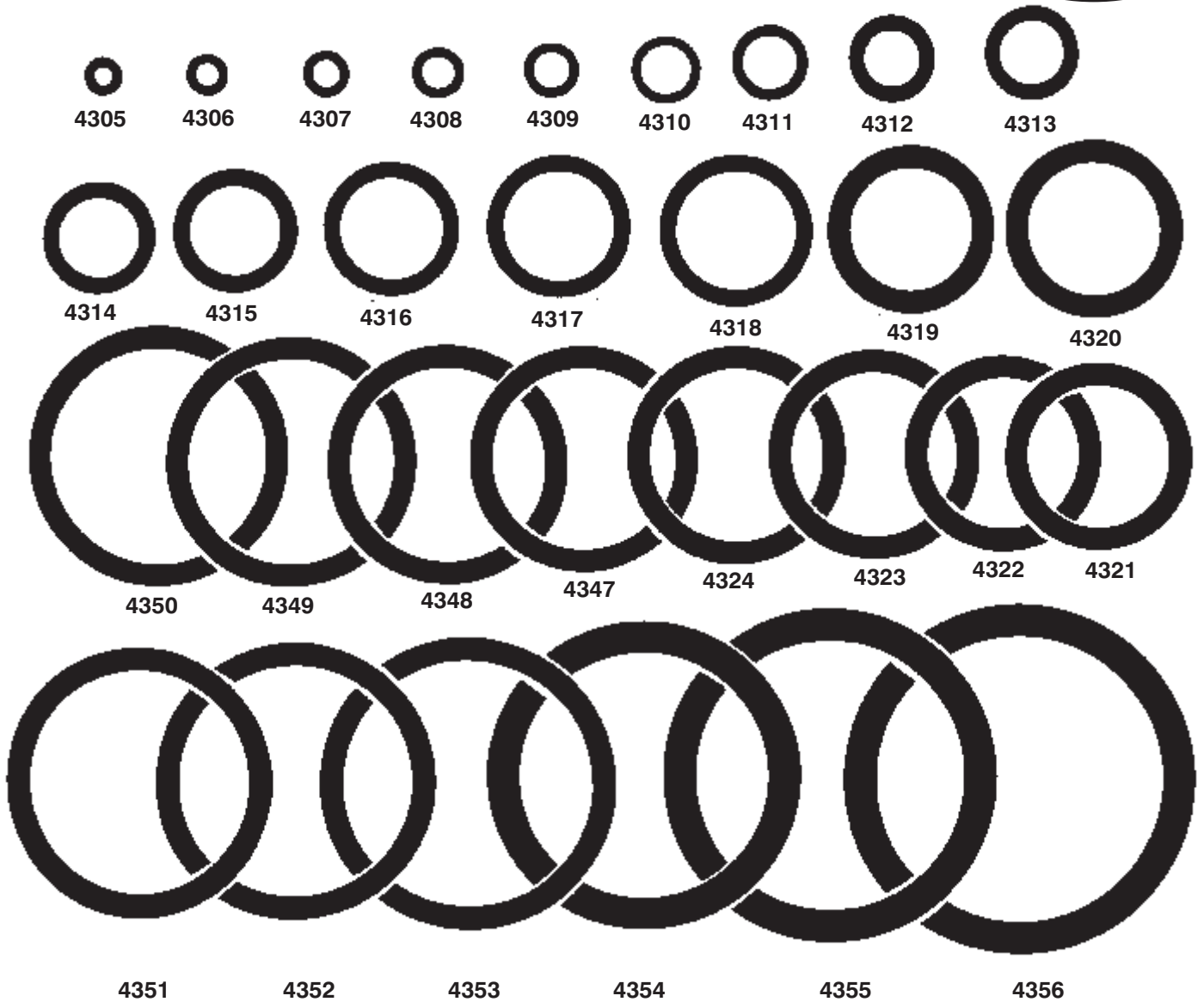

**THICKNESS**

- 4305 thru 4311 .....1/16"
- 4312 thru 4318 .....3/32"
- 4319 thru 4353 .....1/8"
- 4354 thru 4356 .....13/64"

Temperature Rating: 70 hours @ 100°C

Auveco Part No.	Ind. Std.	I.D.	O.D.	Unit Pkg.	Auveco Part No.	Ind. Std.	I.D.	O.D.	Unit Pkg.
4305	.006	1/8"	1/4"	50	4320	.211	13/16"	1-1/16"	50
4306	.007	5/32"	9/32"	50	4321	.212	7/8"	1-1/8"	50
4307	.008	3/16"	5/16"	50	4322	.213	15/16"	1-3/16"	50
4308	.009	7/32"	11/32"	50	4323	.214	1"	1-1/4"	50
4309	.010	1/4"	3/8"	50	4324	.215	1-1/16"	1-5/16"	50
4310	.011	5/16"	7/16"	50	4347	.216	1-1/8"	1-3/8"	25
4311	.012	3/8"	1/2"	50	4348	.217	1-3/16"	1-7/16"	25
4312	.110	3/8"	9/16"	50	4349	.218	1-1/4"	1-1/2"	25
4313	.111	7/16"	5/8"	50	4350	.219	1-5/16"	1-9/16"	25
4314	.112	1/2"	11/16"	50	4351	.220	1-3/8"	1-5/8"	25
4315	.113	9/16"	3/4"	50	4352	.221	1-7/16"	1-11/16"	25
4316	.114	5/8"	13/16"	50	4353	.222	1-1/2"	1-3/4"	25
4317	.115	11/16"	7/8"	50	4354	.325	1-1/2"	1-7/8"	25
4318	.116	3/4"	15/16"	50	4355	.326	1-5/8"	2"	25
4319	.210	3/4"	1"	50	4356	.327	1-3/4"	2-1/8"	25

**Sec. 16**

**METRIC BUNA "N" RUBBER "O" RINGS**

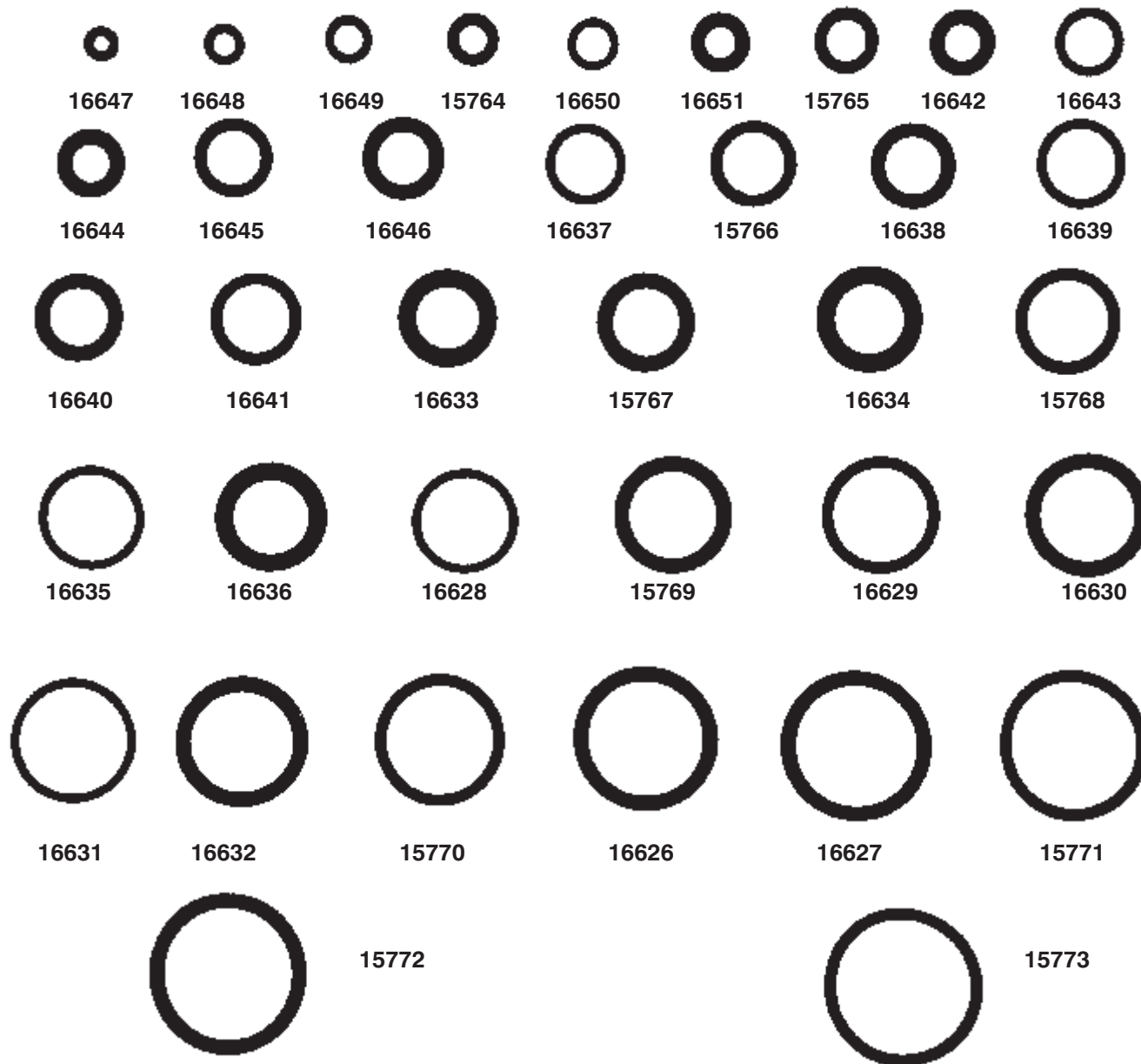

Auveco Part No.	I.D.	O.D.	Thickness	Unit Pkg.
16647	2.2mm	5.4mm	1.6mm	50
16648	3.1mm	6.3mm	1.6mm	50
15764	4mm	8mm	2mm	100
16649	4.1mm	7.3mm	1.6mm	50
16651	4.3mm	9.1mm	2.4mm	50
16650	5mm	8mm	1.5mm	50
16642	5.3mm	10.1mm	2.4mm	50
16644	5.6mm	10.4mm	2.4mm	50
15765	6mm	10mm	2mm	100
16643	7.1mm	10.3mm	1.6mm	50
16646	7.6mm	12.4mm	2.4mm	50
16645	8mm	12mm	2mm	50
16638	8.3mm	13.1mm	2.4mm	50
16640	8.6mm	13.4mm	2.4mm	50
15766	9mm	13mm	2mm	100
16633	9mm	15mm	3mm	50
16637	9.1mm	12.3mm	1.6mm	50
16641	10mm	14mm	2mm	50

Auveco Part No.	I.D.	O.D.	Thickness	Unit Pkg.
15767	10mm	15mm	2.5mm	100
16634	10mm	16mm	3mm	50
16639	10.1mm	13.3mm	1.6mm	50
16636	11mm	17mm	3mm	50
15768	12mm	16mm	2mm	100
16635	13mm	16mm	1.5mm	50
15769	13mm	18mm	2.5mm	100
16628	13.1mm	16.3mm	1.6mm	25
16629	14mm	18mm	2mm	50
16630	14mm	19mm	2.5mm	50
16632	15mm	20mm	2.5mm	50
16631	16mm	19mm	1.5mm	50
15770	16mm	20mm	2mm	50
16626	17mm	22mm	2.5mm	25
16627	18mm	23mm	2.5mm	25
15771	19mm	23mm	2mm	50
15772	19mm	24mm	2.5mm	50
15773	20mm	24mm	2mm	50



# AIR CONDITIONING "O" RINGS

**Sec. 16**

For Use With R12 Refrigerant Only

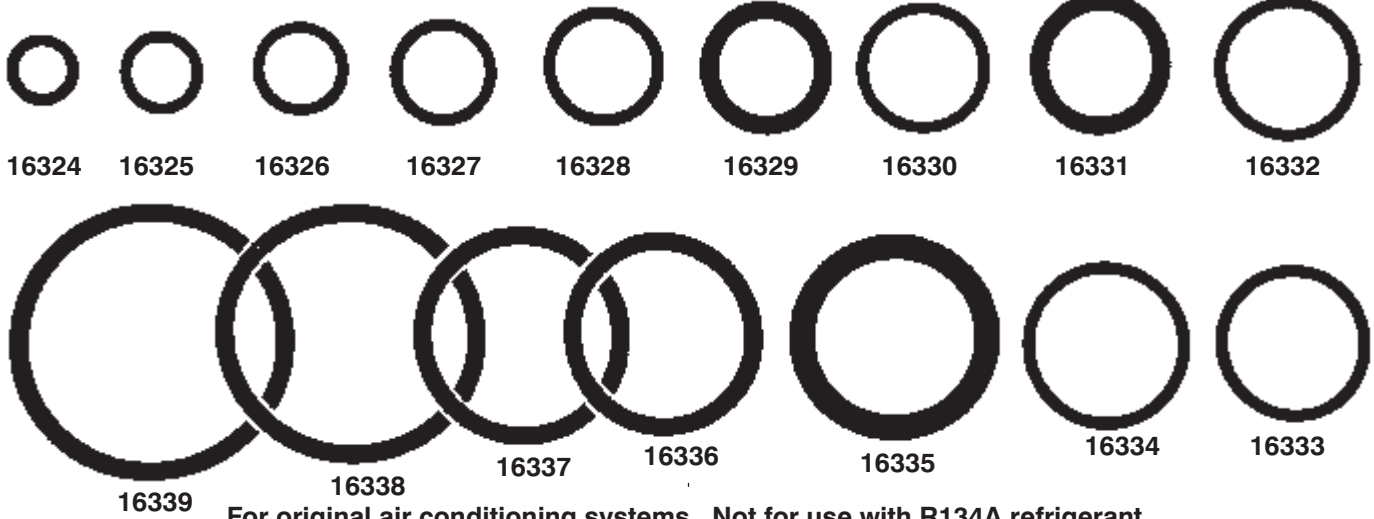

For original air conditioning systems. Not for use with R134A refrigerant.

Auveco Part No.	Ind. Std.	I.D.	O.D.	Thick-ness	Unit Pkg.	Auveco Part No.	Ind. Std.	I.D.	O.D.	Thick-ness	Unit Pkg.
16324	.010	1/4"	3/8"	1/16"	50	16332	.016	5/8"	3/4"	1/16"	50
16325	.011	5/16"	7/16"	1/16"	50	16333	.017	11/16"	13/16"	1/16"	25
16326	.012	3/8"	1/2"	1/16"	50	16334	.018	3/4"	7/8"	1/16"	25
16327	.013	7/16"	9/16"	1/16"	50	16335	.211	13/16"	1-1/16"	1/8"	10
16328	.014	1/2"	5/8"	1/16"	50	16336	.118	7/8"	1-1/16"	3/32"	25
16329	.112	1/2"	11/16"	3/32"	25	16337	.119	15/16"	1-1/8"	3/32"	25
16330	.015	9/16"	11/16"	1/16"	50	16338	.123	1-3/16"	1-3/8"	3/32"	10
16331	.113	9/16"	3/4"	3/32"	25	16339	.124	1-1/4"	1-7/16"	3/32"	10

## Nitrile Air Conditioning "O" Rings

For Use With R12 & R134A Refrigerant

These "O" Rings are either green or black with an orange dot.

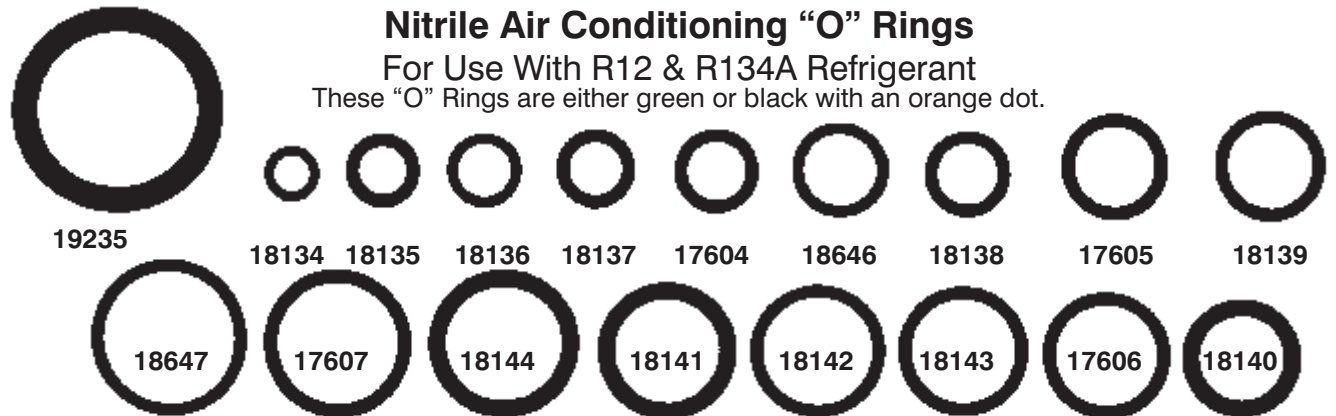

Auveco Part No.	I.D.	O.D.	Thick-ness	OEM No.	Unit Pkg.
17604	.290"	.432"	.071"	Ford: 391396	25
18646	.375"	.500"	.063"		25
17605	.400"	.546"	.073"	Ford: 391397	25
17606	.509"	.655"	.073"	Ford: 391304	25
17607	.617"	.769"	.076"	Ford: 391305	15
18647	.688"	.813"	.063"		25
18134	4.5mm	7.3mm	1.4mm	Nissan: 92472-N8200	25
18135	6mm	9.6mm	1.8mm	Nissan: 92470-N8200	25
18136	6.5mm	9.5mm	1.5mm	Toyota: 90099-14044	25
18137	6.6mm	10.2mm	1.8mm	Acura: 80873-ST7-000	25
18138	7.7mm	11.3mm	1.8mm	Nissan: 92474-N8200	25
18140	10.7mm	15.5mm	2.4mm	Acura: 80872-ST7-000	25
				Nissan: 92475-W1000	
18139	10.8mm	14.4mm	1.8mm	Nissan: 92471-N8200	25
18141	13.3mm	18.1mm	2.4mm	Acura: 80871-ST7-000	25
18143	13.4mm	17.2mm	1.9mm	Toyota: 90099-14045	15
18142	14mm	17.6mm	1.8mm	Nissan: 92473-N8200	25
18144	14.8mm	19.6mm	2.4mm	Nissan: 92475-W2100	15
19235	13/16"	1-1/16"	1/8"		10

# Sec. 16 BLUE NEOPRENE AIR CONDITIONING "O" RINGS

Teflon Coated • For Use With R134A & R12 Refrigerant

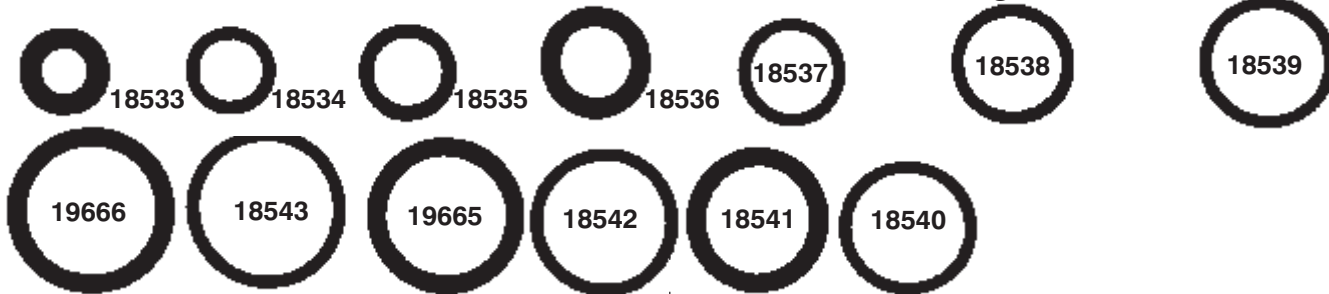

Auveco Part No.	Ind. Std.	I.D.	O.D.	Thick-ness	Unit Pkg.	Auveco Part No.	Ind. Std.	I.D.	O.D.	Thick-ness	Unit Pkg.
18533	.....108	.....1/4"	.....7/16"	.....3/32"	.....25	18540	.....015	.....9/16"	.....11/16"	.....1/16"	.....25
18534	.....011	.....5/16"	.....7/16"	.....1/16"	.....25	18541	.....113	.....9/16"	.....3/4"	.....3/32"	.....25
18535	.....012	.....3/8"	.....1/2"	.....1/16"	.....25	18542	.....016	.....5/8"	.....3/4"	.....1/16"	.....25
18536	.....110	.....3/8"	.....9/16"	.....3/32"	.....25	19665	.....114	.....5/8"	.....13/16"	.....3/32"	.....25
18537	.....013	.....7/16"	.....9/16"	.....1/16"	.....25	18543	.....017	.....11/16"	.....13/16"	.....1/16"	.....25
18538	.....014	.....1/2"	.....5/8"	.....1/16"	.....25	19666	.....115	.....11/16"	.....7/8"	.....3/32"	.....25
18539	.....112	.....1/2"	.....11/16"	.....3/32"	.....25						

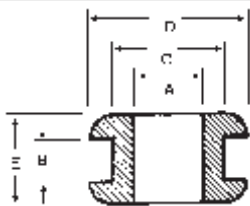

## Vinyl Grommets

- Black Vinflex 163
- Exceptional aging qualities
- High Dielectric properties
- Oil resistant
- Non-Conductive
- Durometer hardness 60
- Excellent Resistance to ozone and sunlight

Auveco Part No.	"A" Bore Diameter	"B" Groove Width	"C" Groove Diameter	"D" Outside Diameter	"E" Overall Thickness	Unit Pkg.
14763	3/16"	1/16"	5/16"	7/16"	7/32"	50
14764	1/4"	1/16"	3/8"	9/16"	1/4"	50
14765	5/16"	1/16"	7/16"	5/8"	1/4"	50
14766	3/8"	1/16"	1/2"	5/8"	1/4"	50
14767	1/2"	1/16"	5/8"	13/16"	9/32"	25



Made of SBR Material  
Durometer Hardness 60

All Packed 25

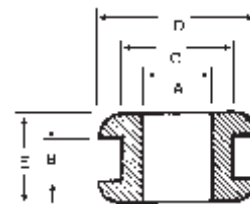

Auveco Part No.	A Bore Dia.	B Groove Width	C Groove Dia.	D Outside Dia.	E Overall Thickness	Auveco Part No.	A Bore Dia.	B Groove Width	C Groove Dia.	D Outside Dia.	E Overall Thickness
4408	.....1/8"	.....3/32"	.....3/8"	.....1/2"	.....5/16"	16456	.....3/8"	.....1/16"	.....5/8"	.....7/8"	.....11/32"
4410	.....5/32"	.....1/16"	.....1/4"	.....3/8"	.....3/16"	4425	.....3/8"	.....1/16"	.....1"	.....1-1/4"	.....1/4"
4411	.....5/32"	.....3/32"	.....1/4"	.....7/16"	.....3/8"	4426	.....3/8"	.....1/4"	.....5/8"	.....7/8"	.....1/2"
4413	.....3/16"	.....1/16"	.....5/16"	.....1/2"	.....1/4"	16457	.....7/16"	.....1/16"	.....9/16"	.....3/4"	.....1/4"
4414	.....3/16"	.....3/32"	.....9/32"	.....3/8"	.....5/16"	4428	.....1/2"	.....3/32"	.....3/4"	.....31/32"	.....9/32"
4415	.....3/16"	.....1/4"	.....5/16"	.....7/16"	.....3/8"	4429	.....1/2"	.....3/32"	.....25/32"	.....1"	.....11/32"
16454	.....1/4"	.....1/16"	.....3/8"	.....1/2"	.....3/16"	16458	.....1/2"	.....1/8"	.....3/4"	.....1"	.....1/2"
4417	.....1/4"	.....1/16"	.....7/16"	.....5/8"	.....3/16"	4430	.....1/2"	.....1/4"	.....13/16"	.....1-1/16"	.....1/2"
4418	.....1/4"	.....1/16"	.....1"	.....1-1/4"	.....1/4"	4431	.....5/8"	.....1/8"	.....7/8"	.....1-1/8"	.....3/8"
4419	.....5/16"	.....1/16"	.....7/16"	.....9/16"	.....3/16"	4432	.....5/8"	.....1/16"	.....7/8"	.....1-1/8"	.....5/16"
4420	.....5/16"	.....1/16"	.....9/16"	.....13/16"	.....5/16"	4433	.....3/4"	.....1/16"	.....15/16"	.....1-1/8"	.....1/4"
16455	.....5/16"	.....1/16"	.....3/4"	.....1"	.....5/16"	4434	.....3/4"	.....1/16"	.....1-1/16"	.....1-3/8"	.....3/8"
4421	.....5/16"	.....1/8"	.....9/16"	.....13/16"	.....3/8"	4435	.....3/4"	.....1/16"	.....1-1/4"	.....1-5/8"	.....1/4"
4422	.....5/16"	.....1/4"	.....9/16"	.....13/16"	.....1/2"	4436	.....3/4"	.....1/4"	.....1-1/4"	.....1-5/8"	.....7/16"
4423	.....3/8"	.....1/16"	.....1/2"	.....5/8"	.....9/32"						

# GROMMETING & TIRE VALVES

## Flexible Serrated Polyethylene Grommeting (Natural Color)

Grommeting is primarily used to protect wires and cables from sharp panel edges. Wires that are routed through knock-outs or over sharp edges need to be prevented from chafing against those edges. Grommeting can also be used to protect the edges of glass, sheet metal, wood panels, or other sheet-form materials. Depending on the panel thickness of the application, grommeting may grip tightly by itself—if not, a touch of epoxy will keep it in place.

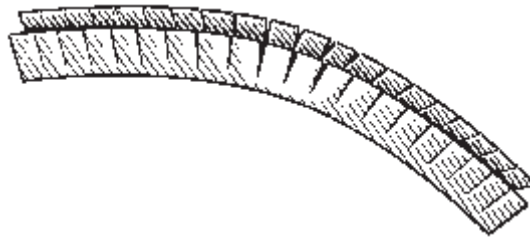
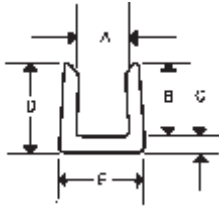

Auveco Part No.	"A" Max. Panel Thickness	"B"	"C"	"D"	"E"	Unit Pkg.
<b>15974</b>	.040"	.150"	.040"	.190"	.125"	100FT.
<b>15975</b>	.052"	.150"	.040"	.190"	.125"	100FT.
<b>15976</b>	.062"	.155"	.045"	.200"	.170"	100FT.
<b>15977</b>	.085"	.155"	.045"	.200"	.170"	100FT.
<b>15978</b>	.100"	.175"	.045"	.220"	.210"	100FT.
<b>15979</b>	.125"	.175"	.045"	.220"	.210"	100FT.
<b>15980</b>	.187"	.222"	.045"	.270"	.275"	100FT.
<b>15981</b>	.250"	.230"	.050"	.280"	.370"	100FT.

## TUBELESS TIRE VALVES



1-1/4" Long  
29/64" Rim Hole  
(TR413)

Auveco No. **10184** - U.P. 5  
 Auveco No. **10191** - U.P. 25  
 Auveco No. **10192** - U.P. 100

1-1/4" Long  
5/8" Rim Hole  
(TR415)

Auveco No. **10188** - U.P. 5  
 Auveco No. **10203** - U.P. 25  
 Auveco No. **10204** - U.P. 100

2" Long  
29/64" Rim Hole  
(TR418)

Auveco No. **10186** - U.P. 5  
 Auveco No. **10197** - U.P. 25  
 Auveco No. **10198** - U.P. 100

# Sec. 16

## SPONGE WEATHERSTRIPS

Peel-Bak Adhesive Neoprene Sponge Weatherstrip

A light-weight closed cell sponge material, Peel-Bak is an easy to apply type of weatherstrip for auto and household use. May also be used on boats, refrigerators or any place a weatherproof, permanent seal is required. Simple to use - just peel back the liner tape and press into place. No cement or tacking required. Surface must be clean and dry.

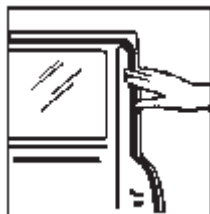

Press On  
Clean Dry  
Surface

Thickness	Width	10 Ft. Roll Auveco Part No.	50 Ft. Roll Auveco Part No.
5/32"	3/8"	<b>4800</b>	<b>4850</b>
5/32"	1/2"	<b>4801</b>	<b>4851</b>
5/32"	5/8"	<b>4802</b>	—
5/32"	3/4"	<b>4803</b>	<b>4852</b>
5/32"	1"	<b>4804</b>	<b>4853</b>
5/16"	3/8"	<b>4805</b>	<b>4854</b>
5/16"	3/8"	<b>16431*</b>	—
5/16"	1/2"	<b>4806</b>	<b>4855</b>
5/16"	5/8"	<b>4807</b>	—
5/16"	3/4"	<b>4808</b>	<b>4856</b>
5/16"	1"	<b>4809</b>	<b>4857</b>
7/16"	3/8"	<b>4810</b>	<b>4858</b>
7/16"	1/2"	<b>4811</b>	<b>4859</b>
7/16"	3/4"	<b>4812</b>	<b>4860</b>
7/16"	1"	<b>4813</b>	<b>4861</b>

\*Light Gray adhesive vinyl foam sponge weatherstrip

### EXACT SIZE PROFILES

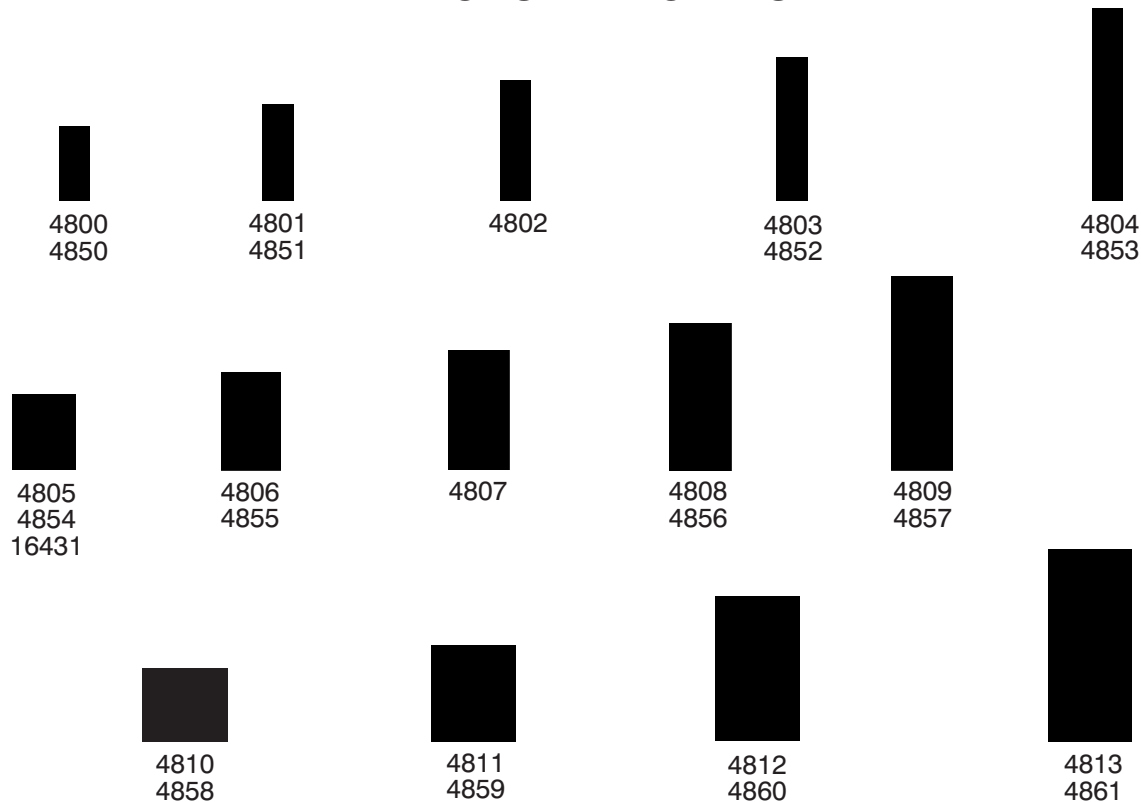

# SPONGE RUBBER WEATHERSTRIPS

**Sec. 16**

ACTUAL SIZE ILLUSTRATIONS -EPDM NEOPRENE BLEND CLOSED CELL

Light Weight -Weather Resistant



**4675** UNIT PACKAGE: 50 Ft.  
**16390** UNIT PACKAGE: 15 Ft.

Door Flange Weatherstrip  
GM, Ford & Chrysler  
Cars & Trucks



**4731**

Door Flange Weatherstrip  
GM 1954-53  
Universal

UNIT PACKAGE: 50 Ft.



**4744** UNIT PACKAGE: 50 Ft.  
**16391** UNIT PACKAGE: 15 Ft.

Door Flange Weatherstrip  
GM: 1955-On



**4707**

Door Flange Weatherstrip  
Chrysler 1954-50  
Ford 1958-50

UNIT PACKAGE: 50 Ft.



**4745** UNIT PACKAGE: 50 Ft.  
**16392** UNIT PACKAGE: 15 Ft.

Door Flange Weatherstrip  
Ford 1955-On



**4746** UNIT PACKAGE: 50 Ft.  
**16393** UNIT PACKAGE: 15 Ft.

Door Flange Weatherstrip  
Chrysler 1958-On



**4747**

Door Inner Belt Weatherstrip  
All Cars 1970-55

UNIT PACKAGE: 50 Ft.



**4742**

Trunk & Lid Weatherstrip  
GM 1959-On  
Ford 1949-On  
Studebaker 1967-55

UNIT PACKAGE: 50 Ft.



**4712**

Trunk & Rear Deck Gutter  
Weatherstrip  
GM 1954-49

UNIT PACKAGE: 50 Ft.



**4703** UNIT PACKAGE: 50 Ft.  
**16395** UNIT PACKAGE: 15 Ft.

Trunk & Rear Deck Gutter  
Weatherstrip  
GM

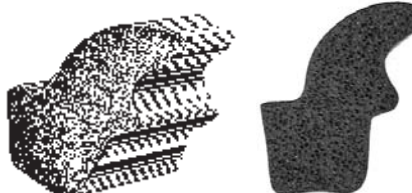

**4749** UNIT PACKAGE: 50 Ft.  
**16394** UNIT PACKAGE: 15 Ft.

Deck Lid Weatherstrip  
GM 1956-On



**16890** UNIT PACKAGE: 25 Ft.  
**16891** UNIT PACKAGE: 50 Ft.

Door Flange Weatherstrip  
Ford 1956-53



**16892**

Roof Rail Weatherstrip  
GM 1977-68

UNIT PACKAGE: 25 Ft.

**Sec. 16**

**SPONGE RUBBER WEATHERSTRIPS**

ACTUAL SIZE ILLUSTRATIONS -EPDM NEOPRENE BLEND CLOSED CELL

Light Weight -Weather Resistant

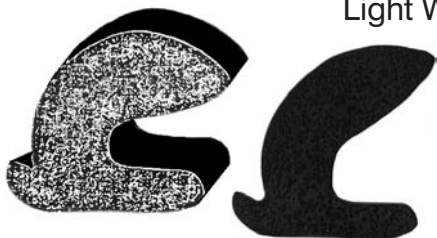

**4743**

Trunk Weatherstrip  
Universal

UNIT PACKAGE: 35 Ft.



**4750**

(C5AZ-6243720-B)

Deck Lid Weatherstrip  
Ford 1956-On

UNIT PACKAGE: 50 Ft.



**16524**

Door Seal Weatherstrip  
GM 1972-64

UNIT PACKAGE: 50 Ft.

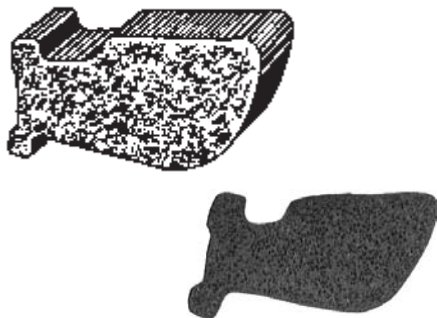

**16522**

Top of Door Seal  
GM Late 1970's

UNIT PACKAGE: 25 Ft.



**16523**

Door Seal Weatherstrip  
GM 1972-On

UNIT PACKAGE: 50 Ft.



**16525**

Door Seal Weatherstrip  
GM 1963-55

UNIT PACKAGE: 50 Ft.



4654

4655

4656



4740

19341

Extruded Closed Cell Sponge  
Rubber. Will not absorb water or  
moisture. Without Cement.

19341 1/8" Thick -3/4" Wide

4740 1/8" Thick -1-1/2" Wide

UNIT PACKAGE: 25 Ft.

(One Size)



4736

4737

4738



Closed Cell  
Half Round  
Sponge Rubber

4736 .....1/4" Half Round

4737 .....3/8" Half Round

4738 .....1/2" Half Round

UNIT PACKAGE: 50 Ft.

(One Size)

**Closed Cell  
Sponge Rubber Windlace Cord**  
Flexible filler for cloth covered  
windlace on door and windshield  
pillars and door bottoms.

4654 .....1/4" Diameter

4655 .....3/8" Diameter

4656 .....1/2" Diameter

UNIT PACKAGE: 50 Ft.

(One Size)

**Molded Dense Rubber**



Tee Rubber  
Concave Head

4530 .....3/4" .....9/32" Head

4531 .....1" .....9/32" Head

UNIT PACKAGE: 50 Ft.

(One Size)

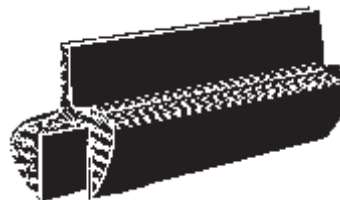

**4581**

Windshield glass weatherstrip for 1/4" glass

UNIT PACKAGE: 50 Ft.

# RUBBER BUMPERS & GROMMETS

**Sec. 16**

(ILLUSTRATIONS ACTUAL SIZE)



**4280**

(3745361, 3762180)  
License Plate Bumper  
GM

UNIT PACKAGE: 25



**4406**

Brake Adjusting Screw  
Hole Rubber Plug  
Fits 5/16" x 1" Hole

UNIT PACKAGE: 25



**8275**

Brake Adjusting Screw  
Hole Nylon Plug  
Fits 3/8" x 1" Hole

UNIT PACKAGE: 100



**4260**

(17562)

Windshield Wiper Rubber Grommet  
1 1/32" I.D.  
5/8" O.D.  
3/16" Thick  
Ford

UNIT PACKAGE: 25



**4246**

(357811)

Gas Tank Lid Rubber Bumper  
Ford

UNIT PACKAGE: 25



**4242**

(4137121)

Trunk, Rear Deck Lid, & Hood  
Bumper  
GM

UNIT PACKAGE: 25



**4243**

(513388)

Hood To Ledge Bumper  
GM

UNIT PACKAGE: 25



**4265**

(3711168)

Door Lock Striker Plate,  
Window Glass Stop  
& License Plate Bumper  
GM

UNIT PACKAGE: 25



**4188**

(4081765)

Door & Quarter Glass  
And Door Opening Header Bumper  
GM

UNIT PACKAGE: 25



**4237**

(3664645)

General Purpose  
GM

UNIT PACKAGE: 25



**4235**

(3688811)

Hood Top Panel Side  
Bumper To Fender  
GM

UNIT PACKAGE: 25

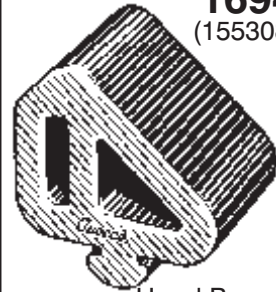

**16943**

(15530810)

Hood Bumper  
GM Trucks  
C, K Models 1988-On

UNIT PACKAGE: 10

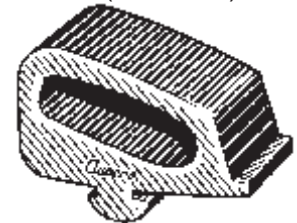

**16944**

(14027125)

Hood Bumper  
GM Trucks  
S-10 Models 1992-82

UNIT PACKAGE: 10

**FasTrack**  
**Auveco's Cost**  
**Recovery System For**  
**Repair Fasteners...**

**Never Lose Money**  
**On Fasteners Again!**

**Sec. 16**

**RUBBER BUMPERS & GROMMETS**

(ILLUSTRATIONS ACTUAL SIZE)



**4248**  
(16758)

General Purpose  
Ford

UNIT PACKAGE: 25



**4264**  
(4564974)

Front Door Bumper  
GM

UNIT PACKAGE: 25

You Can E-Mail Your  
New Item Suggestions  
To [mail@auveco.com](mailto:mail@auveco.com)



**4369**  
(3900684)  
(15029828)

Pillar Bumper  
GM Trucks

UNIT PACKAGE: 25



**4258**  
(352839)

General Purpose  
Ford

UNIT PACKAGE: 25

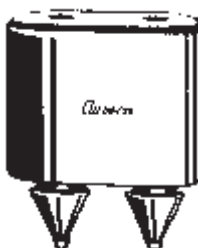

**4441**  
(4565591,  
7637192,  
20376243)

Front Door Bumper  
GM

UNIT PACKAGE: 25



**4249**  
(1304225)

General Purpose  
GM

UNIT PACKAGE: 25



**4447**  
(7724826)

Trunk Lid Bumper  
GM

UNIT PACKAGE: 10

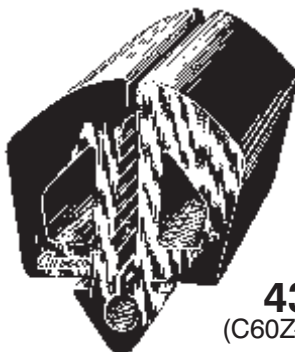

**4357**  
(C60Z-16758-A)

Hood to Fender Bumper  
Ford

UNIT PACKAGE: 25



**4250**  
(3693292)

Glove Box Door Bumper  
GM

UNIT PACKAGE: 25



**13967**

General Purpose  
Head: 1/2" O.D. x 5/16" Long  
Fits Into 1/4" Hole  
Durometer: 55-65

UNIT PACKAGE: 25



**4233**  
(3655015)

General Purpose  
GM

UNIT PACKAGE: 25



**4155**  
(16758A)

General Purpose  
Ford

UNIT PACKAGE: 25



**4446**  
(4872948)

Trunk Lid Bumper  
GM

UNIT PACKAGE: 25

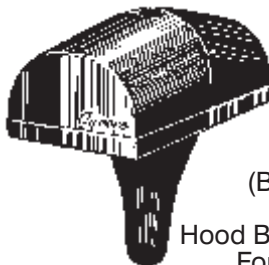

**4273**  
(B7A-16758-A)

Hood Bumper  
Ford

UNIT PACKAGE: 25



**4244**  
(972724)

General Purpose  
Chrysler

UNIT PACKAGE: 25



# RUBBER BUMPERS & GROMMETS

(ILLUSTRATIONS ACTUAL SIZE)



**4204**  
(4023030)

General Purpose  
Ford & Chrysler

UNIT PACKAGE: 25



**4240**  
(4563173,  
4565415)

Door Bumper  
GM

UNIT PACKAGE: 25



**4236**  
(3689084)

General Purpose  
GM

UNIT PACKAGE: 25



**4281**  
(4721222)

Trunk Lid Bumper  
GM

UNIT PACKAGE: 25



**4266**  
(3760155)

Hood & Grille Bumper  
GM

UNIT PACKAGE: 25



**19340**  
(3538281)  
Rubber

Air Inlet Screen  
Rubber Retainer  
Head Diameter: 1"  
Stem Length: 5/16"  
Fits Into 1/4" Hole  
Cadillac DeVille,  
Eldorado & Seville  
1992-On

UNIT PACKAGE: 10



**20698**  
Black Rubber

Cigarette Lighter  
Safety Plug

Used to replace unwanted  
cigarette lighters.  
Prevents accidental shocks  
and burns.

Discourages smoking in the car.  
The tight fit deters removal.

UNIT PACKAGE: 2



**19624**  
(74144-SR3-000)  
Black Rubber

Hood Bumper &  
Headlight Seal  
Outside Dia.: 20mm  
Overall length: 37mm  
Acura: Integra  
Honda: Civic & CR-V  
1993 - On

UNIT PACKAGE: 5



**19625**  
(90541-15004)  
Black Rubber

Hood Bumper  
Outside Dia.: 22mm  
Overall Length: 28mm  
Toyota: Avalon & Previa  
1990-On

UNIT PACKAGE: 5

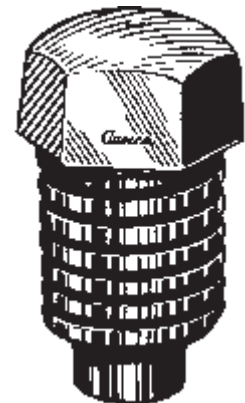

**15453**  
(472450, 12338034)

Hood Bumper  
GM X Cars 1980-On  
Across The Flats: 1"  
Diameter: 15/16"  
Overall Length: 1-29/32"

UNIT PACKAGE: 10

# RUBBER BUMPERS & GROMMETS

(ILLUSTRATIONS ACTUAL SIZE)



**15455**

(1717924, 12337963)

Trunk Lid Bumper  
Across The Flats: 3/4"  
Diameter: 11/16"  
Overall Length: 1-1/4"  
GM 1979-On

UNIT PACKAGE: 10



**20418**

(5020040-AA)  
Black Rubber

Hood Bumper  
Across The Flats: 1-1/8"  
Diameter: 23/32"  
Overall Length: 2-3/16"  
Chrysler Mini-Vans  
2002 - On

UNIT PACKAGE: 10

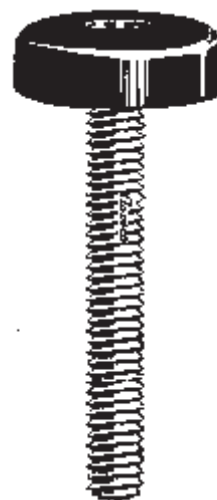

**4474**

(400765)

5/16-18 x 2-1/8"  
Hood Adjusting Bolt & Bumper  
GM

UNIT PACKAGE: 5

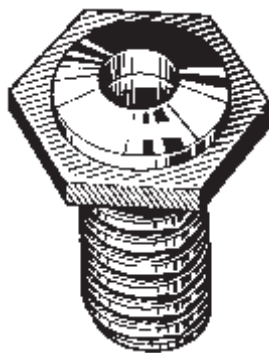

**14216**

(4103165)  
Nylon

Hood Bumper  
Across The Flats: 28mm  
Diameter: 18mm  
Overall Length: 47mm  
Chrysler 1981-On

UNIT PACKAGE: 10

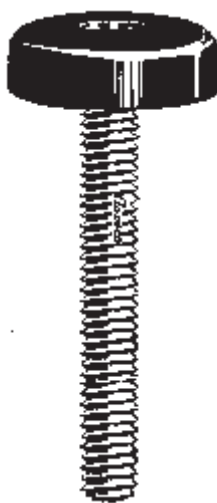

**4473**

(400764)

5/16-18 x 2-1/8"  
Hood Adjusting Bolt & Bumper  
GM

UNIT PACKAGE: 10

Do You Want Your  
Customers To Know  
You Use The Best  
Body Hardware &  
Specialty Fasteners  
Available?

Promotional Products  
And Apparel Bearing

The  Logo

Promote  
Your Identity As A  
Professional.

**RUBBER BUMPERS & GROMMETS**

(ILLUSTRATIONS ACTUAL SIZE)



**16849**  
(Not Supplied Separately By O.E.M.)  
Nylon

Hood Adjustment Nut  
Ford 1989-On  
M6-1.0 Threaded Insert

UNIT PACKAGE: 10

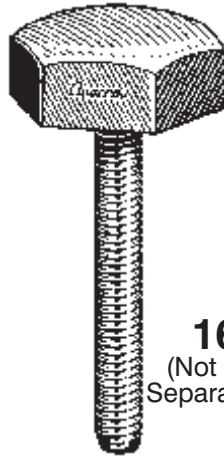

**16850**  
(Not Supplied Separately By O.E.M.)  
Zinc

Hood Adjustment Bumper  
Ford 1989-On  
M6-1.0 x 44mm  
23mm Hex

UNIT PACKAGE: 5

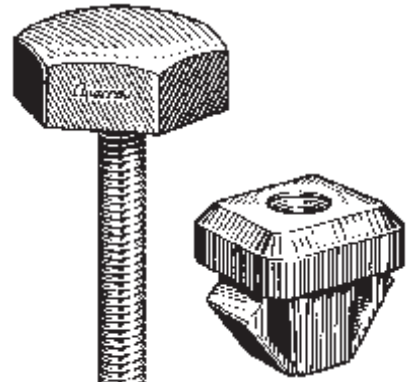

**16832**  
(E83Z-16758-A)

Hood Adjustment Nut & Bumper  
Ford 1989-On

UNIT PACKAGE: 2 Sets

**Self-Adhesive Bumpers**

Clear material, self-adhesive bumpers press easily onto almost any smooth surface and stay on without holes, screws or rivets. Our bumpers are made of modified PVC and are skid and scratch resistant. The surface to which the bumper is applied should be clean, dry and free of grease and oil to obtain maximum adhesion.

Recommended storage temperature is 40Deg. F (4 Deg. C) to 75 Deg. F (24 Deg. C).



**15984**



**15986**

Auveco Part No.	Dia.	Height	Description	Unit Pkg.
<b>15984</b>	1/2"	9/64"	Cylindrical Concavity	50
<b>15986</b>	1/2"	3/32"	Cylindrical	50



**Rubber Headed Tack Bumpers**

- Styrene Butadiene Rubber (SBR)
- 70 Durometer

Auveco Part No.	Color	Head Dia.	Head Height	Nail Length	Unit Pkg.
<b>16461</b>	Black	3/8"	1/4"	3/8"	25
<b>16463</b>	Black	1/2"	5/16"	3/8"	25
<b>16467</b>	Black	3/4"	7/16"	1/2"	25

# Sec. 16

## Rubber Caps

(Special Heat Resistant Material)



Can be used for capping lines and hoses while testing carburetors, emission control systems, vacuum lines, etc.



Auveco Part No.	Fits Tube O.D.	Inside Length	Unit Pkg.	Auveco Part No.	Fits Tube O.D.	Inside Length	Unit Pkg.
<b>12209</b>	1/8"	9/16"	25	<b>19002</b>	5/16"	9/16"	25
<b>4440</b>	3/16"	9/16"	25	<b>12907</b>	5/16"	1-1/4"	25
<b>16264</b>			100	<b>12210</b>	3/8"	31/32"	25
<b>19000</b>	3/16"	1-1/4"	25	<b>19003</b>	3/8"	1-1/2"	25
<b>4439</b>	1/4"	9/16"	25	<b>12908</b>	1/2"	11/16"	10
<b>19001</b>	1/4"	1-1/4"	25				

## Vinyl Vacuum Caps



Can be used for capping lines and hoses while testing carburetors, emission control systems, vacuum lines, etc. Color coded for size identification.

Auveco Part No.	I.D.	Fits Tube O.D.	Color	Length	Unit Pkg.
<b>18202</b>	1/8"	3/16"	Blue	5/8"	50
<b>18203</b>	3/16"	1/4"	Red	5/8"	50
<b>18204</b>	1/4"	5/16"	White	5/8"	50
<b>18205</b>	5/16"	3/8"	Black	5/8"	50

## Rubber Hold Down Straps W/Hooks



Auveco Part No.	Length	Span Range	Unit Pkg.
<b>4448</b>	9"	15" to 20"	10
<b>4449</b>	15"	20" to 30"	10
<b>4450</b>	20"	30" to 40"	10
<b>4451</b>	31"	40" to 55"	10

### 11298

Galvanized

3/16" x 3" - "S" Hook  
Used with Auveco Rubber Hold Down Straps No. 4448, 4449, 4450 and 4451

UNIT PACKAGE: 50

### 11299

Same As 11298  
Except For Packing

UNIT PACKAGE: 100



# GLASS SETTING CHANNELS

EPDM Dense Rubber



**4511**

For 1/8" Glass  
 Height 11/32"  
 Width at Base 1/4"  
 Inside Base 1/8"  
 Glass Setting Channel

UNIT PACKAGE: 50 Ft.



**4515**

For 1/4" Glass  
 Height 9/16"  
 Width at Base 25/64"  
 Inside Base 1/4"  
 Glass Setting Channel

UNIT PACKAGE: 50 Ft.



**4588**

For 1/4" Glass  
 Height 9/16"  
 Width at Base 7/16"  
 Inside Base 1/4"  
 Windshield And Rear Window  
 Glass Setting Channel

UNIT PACKAGE: 50 Ft.



**4512**

For 3/16" Glass  
 Height 7/16"  
 Width at Base 27/64"  
 Inside Base 3/16"

Windshield And Rear Window  
 Glass Setting Channel

UNIT PACKAGE: 50 Ft.



**4513**

For 1/4" Glass  
 Height 7/16"  
 Width at Base 31/64"  
 Inside Base 1/4"

Windshield And Rear Window  
 Glass Setting Channel

UNIT PACKAGE: 50 Ft.



**4516**

For 3/16" Glass  
 Height 7/16"  
 Width at Base 3/8"  
 Inside Base 3/16"

Glass Setting Channel

UNIT PACKAGE: 50 Ft.



**4670**

For 1/4" Glass

Windshield Rear Window Glass Set-  
 ting Channel And Weatherstrip  
 Ford, Mercury Early Models

UNIT PACKAGE: 50 Ft.

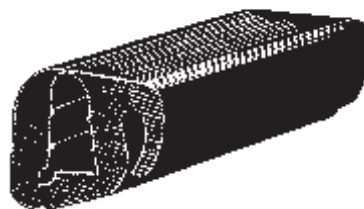

**4688**

For 1/4" Glass

Rear Window Glass  
 Setting Channel  
 Chrysler Early Models

UNIT PACKAGE: 50 Ft.



**4671**

For 1/4" Glass

Rear Window Glass  
 Setting Channel And Weatherstrip  
 Chrysler - Early Models

UNIT PACKAGE: 50 Ft.

**Sec. 16**

**EPDM Rubber Weatherstrip For Glass**



**17509**

Glass Thickness: 1/4"  
Body Thickness: 1/16"  
Self-Locking Type

UNIT PACKAGE: 50 Ft.

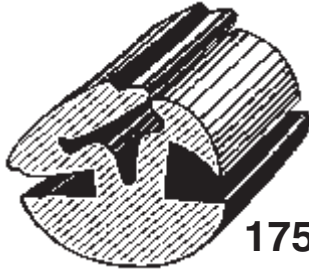

**17510**

Glass Thickness: 1/4"  
Body Thickness: 1/8"  
Self-Locking Type

UNIT PACKAGE: 50 Ft.



**17513**

Glass Thickness: 1/4"  
Body Thickness: 1/8"  
Bead Lock Type  
Use With 17514

UNIT PACKAGE: 50 Ft.

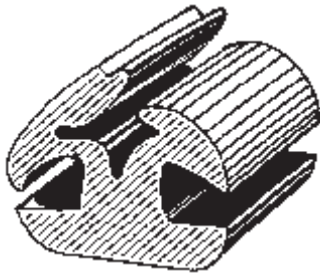

**17511**

Glass Thickness: 1/4"  
Body Thickness: 1/4"  
Self-Locking Type

UNIT PACKAGE: 50 Ft.

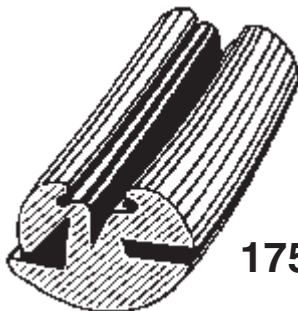

**17512**

Glass Thickness: 1/4"  
Body Thickness: 1/16"  
Bead Lock Type  
Use With 17514

UNIT PACKAGE: 50 Ft.



**17514**

Glass Thickness 1/4"  
Locking Bead  
Use With 17512 & 17513

UNIT PACKAGE: 50 Ft.

**Windshield Filler Strips**

Made of vinyl and packaged on spools for easy dispensing.

→ 33/64" ←

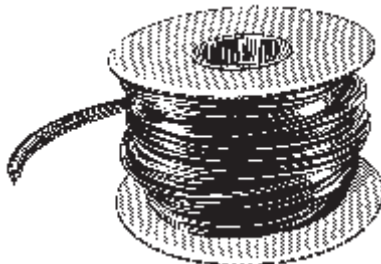

**15681**  
(4314873)

Chrysler Voyager,  
Caravan & Ram Van  
1984-On

UNIT PACKAGE: 100 Ft.

**Universal Windshield & Rear Window  
Flex-Fit Rubber Moulding**

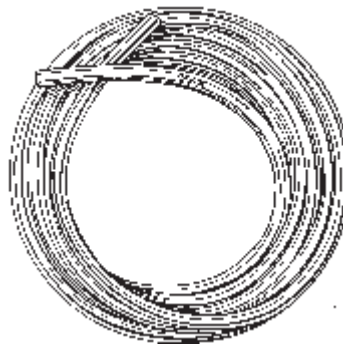

→ 5/8" ←  
3/16" ↑

**20342**

A universal windshield rubber moulding for domestic and import vehicles. Made of EPDM rubber, this moulding contains a butyl bead that adheres to the glass during installation. The profile design allows for the moulding to attach easily to the glass edge and lay evenly on the vehicle body along straight areas and around corners. Extruded with a metal filament to prevent stretching and shrinkage.

UNIT PACKAGE: 15 Feet

→ 7/16" ←



**15680**  
(14072598)

GM Astro, Safari Mini Vans,  
& S-10's  
1985-On

UNIT PACKAGE: 100 Ft.

# GLASS SHOP SUPPLIES

**Sec. 17**

(ILLUSTRATIONS ACTUAL SIZE)



**2598**  
(353745-S)

Window regulator arm to plate  
assembly clip  
Ford

UNIT PACKAGE: 100

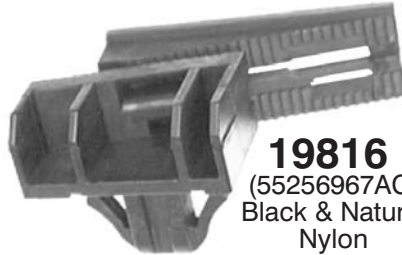

**19816**  
(55256967AC)  
Black & Natural  
Nylon

Windshield Glass  
Adjustable Setting Block  
NAGS Numbers: DW0999  
& DW1295  
Dodge Dakota & Durango  
1997 - On

UNIT PACKAGE: 10



**19817**  
Black Nylon

Universal Glass Setting Block  
Width: 1-3/16"  
Height: 7/16"  
Length: 15/16"

UNIT PACKAGE: 25



**18979**  
(3767196)

Windshield Setting Block  
Lower Spacer  
Chrysler Caravan, Voyager And  
Town & Country  
1984-On

UNIT PACKAGE: 15



**20519**  
(10438101)  
Nylon

Windshield Glass Setting Block  
Width: 3", Height: 1-7/16"  
Buick Century & Regal,  
Chevrolet Impala, Lumina &  
Monte Carlo,  
Oldsmobile Intrigue And Pontiac  
Grand Prix  
2001 - On

UNIT PACKAGE: 10

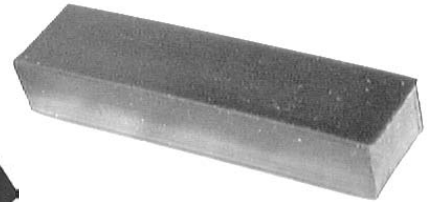

**19818**

Black Hard Rubber

Universal Glass Setting Block  
Width: 1/2"  
Height: 3/8"  
Length: 2"

UNIT PACKAGE: 25

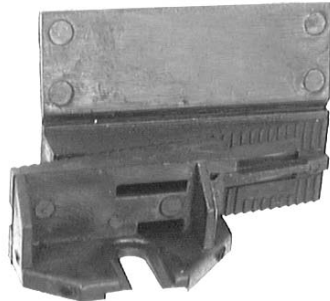

**19815**  
(55275388)  
Natural Nylon

Windshield Glass  
Adjustable Setting Block  
NAGS Numbers: DW1057,  
DW1295, DW0999, DW1176,  
DW1381 & DW1142  
Chrysler Acclaim, Dakota,  
Durango, Full Size Pickup,  
Jeep Grand Cherokee,  
LeBaron & Spirit  
1987 - On

UNIT PACKAGE: 10

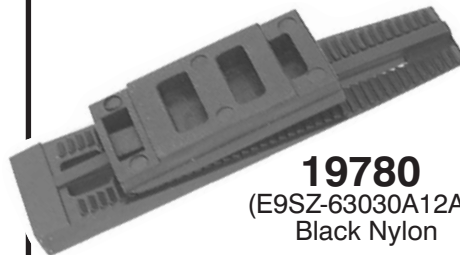

**19780**  
(E9SZ-63030A12A)  
Black Nylon

Windshield Glass  
Adjustable Setting Block  
Width: 9/16", Length: 2-3/8"  
NAGS numbers DW922, 957,  
1019, 1047, 1048, 1091, 1095,  
1171, 1190, 1351 & 1361  
Ford Escort, Mustang, Pick-ups,  
T-Bird & Cougar  
1997 - 80

UNIT PACKAGE: 10



**3135**

Window Regulator  
Roller Assembly  
Ford

UNIT PACKAGE: 25

**Sec. 17**

**GLASS SHOP SUPPLIES**

(ILLUSTRATIONS ACTUAL SIZE)



**10843**  
(3696693)  
Nylon

Front Door Glass Lift to  
Stabilizer Bushing  
Chrysler

UNIT PACKAGE: 50



**19193**  
(D9AZ-54234A46-AA)

Window Glass Retainer  
Front & Rear Doors And  
Tailgate Window Glass  
Channel Bracket Retainer  
Ford 1979-On

UNIT PACKAGE: 25



**2288**

Door And Window Crank Handle  
Retaining Clip  
GM, Ford & Toyota

UNIT PACKAGE: 100



**11469**  
(1698296)  
Nylon

Quarter Window  
Glass Retainer  
GM 1975-On

UNIT PACKAGE: 50

Submitted by "Pop" Gale

**"The bitterness of  
poor quality lingers  
long after the  
sweetness of a low  
price is forgotten."**



**9886**

Door And Window Crank Handle  
Retaining Clip

UNIT PACKAGE: 100



**11**

Door And Window Crank Handle  
Retaining Clip  
Coppered Spring Steel  
GM

UNIT PACKAGE: 100



**19659**  
(F2AZ-5426448-A)  
White Nylon

Bellcrank Door Latch Bushing  
Head Diameter: 25mm  
Fits Into 13mm Hole  
Ford Taurus & Sable  
1992 - On

UNIT PACKAGE: 15



**1267**  
Lacquered

Inside Door Handle & Quarter  
Regulator Handle Escutcheon  
Tension Spring

UNIT PACKAGE: 25



**2451**

Square Wire  
Door And Window Crank Handle  
Retaining Clip

UNIT PACKAGE: 100



# GLASS SHOP SUPPLIES

(ILLUSTRATIONS ACTUAL SIZE)

**Sec. 17**



**16340**

(54229-0201P)  
Cadmium & Yellow

Window Crank Handle  
Retaining Clip  
Nissan

UNIT PACKAGE: 100

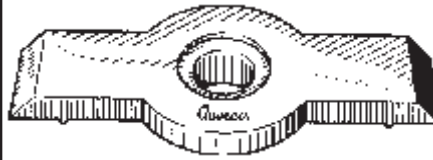

**15813**

(4005714)  
Nylon

Window Glass Retainer  
AMC Eagle 1988-On

UNIT PACKAGE: 25



**9275**

(7634583)

Rear Window Reveal Moulding Clip  
GM 1966-On

UNIT PACKAGE: 50



**11152**

(GM: 9731301)  
(AMC: 4005540)  
Nylon

Windshield to Panel (Lower) Side  
Moulding Clip  
GM 1975-On  
AMC 1975-On

UNIT PACKAGE: 100



**9633**

(7698976)

Windshield Upper & Lower  
Moulding Clip  
GM 1967-On

UNIT PACKAGE: 100



**9639**

(7693140)

Windshield, Skylight, Rear & Quarter  
Window Reveal Moulding Clip  
GM 1966-On

UNIT PACKAGE: 50



**11066**

(9624520)

Window Reveal Moulding Clip  
GM 1973-On

UNIT PACKAGE: 50



**13570**

(AMC: 4006211)  
(Chry: 55134797)  
Nylon

Windshield - Backlite Moulding Clip  
AMC 1974-On

UNIT PACKAGE: 50



**9749**

(7730788)

Windshield, Skylight, Quarter & Rear  
Window Reveal Moulding Clip  
GM 1968-On

UNIT PACKAGE: 50



**11067**

(9606232,  
9662950,  
20603072)

Windshield & Rear Window  
Reveal Moulding Clip  
GM 1973-On

UNIT PACKAGE: 100



**8583**

(4533699)

Rear Window Reveal Moulding Clip  
GM 1965-On

UNIT PACKAGE: 100



**10242**

(8734067)

Rear Window Reveal Moulding Clip  
GM 1969-On

UNIT PACKAGE: 100

**Sec. 17**

**GLASS SHOP SUPPLIES**

(ILLUSTRATIONS ACTUAL SIZE)



**10243**

(8717859,  
9854717)

Rear Window Reveal Moulding Clip  
GM 1969-On

UNIT PACKAGE: 100



**10631**

(9854717)

Windshield Reveal Moulding Clip  
GM 1970-On

UNIT PACKAGE: 50



**17355**

(GM: 94467458;  
Isuzu: 8944674584)  
Nylon

Windshield Reveal Moulding Clip  
Geo Storm  
1992-On

UNIT PACKAGE: 10



**11427**

(Chry: 6003426;  
GM:1654048)

Rear Window Reveal Moulding Clip  
GM 1974-On

UNIT PACKAGE: 100



**11345**

(1654047)

Nylon

Windshield & Rear Window Reveal  
Moulding Clip  
GM 1974-On

UNIT PACKAGE: 100



**20263**

(22599312)  
Black Nylon

Front & Rear Door  
Window Moulding Clip  
Chevrolet Malibu, Oldsmobile  
Achieva & Cutlass  
1997 - On

UNIT PACKAGE: 25



**10701**

(9895598)

Windshield Reveal Moulding Clip  
GM 1971-On

UNIT PACKAGE: 50



**12135**

(20169887)

Nylon

Windshield Reveal  
Moulding Clip  
GM 1979-On

UNIT PACKAGE: 50



**16820**

(75546-12020)

Nylon

Windshield Moulding Clip  
GM Nova 1985-On  
16mm Wide, 49mm Long  
14mm High

UNIT PACKAGE: 25



**10630**

(9808241)

Windshield & Rear Window Reveal  
Moulding Clip  
GM 1970-On

UNIT PACKAGE: 50

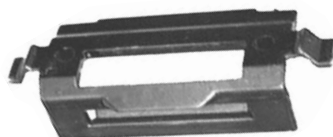

**20232**

(10287926)

Yellow Nylon

Front & Rear Door  
Window Moulding Clip  
Overall Length: 1-9/16"  
Buick Century & Regal  
And Oldsmobile Intrigue  
1997 - On

UNIT PACKAGE: 25



**2628**

(4657731)

Windshield & Rear  
Window Reveal Moulding Fastener  
GM

UNIT PACKAGE: 100

# GLASS SHOP SUPPLIES

(ILLUSTRATIONS ACTUAL SIZE)

**Sec. 17**



**20276**  
(6003409,  
6003752)

Windshield & Rear Window  
Reveal Moulding Clip  
Chrysler 1974 - On  
**Replaces Auveco 11177 & 13569**

UNIT PACKAGE: 25



**10622**  
(6002893)

Rear Window Reveal Moulding Clip  
Chrysler 1971-On

UNIT PACKAGE: 50



**11611**  
(6002893)

Rear Window Reveal Moulding Clip  
Chrysler 1974-On

UNIT PACKAGE: 50



**13567**

(6003878)  
Nylon/Metal

Windshield & Backlite  
Reveal Moulding Clip  
Chrysler "K" Car 1984-On

UNIT PACKAGE: 25



**17295**

(MB-198536)  
Nylon

Windshield Moulding Clip  
Mitsubishi 1984-On  
Dodge Conquest 1984-On

UNIT PACKAGE: 25

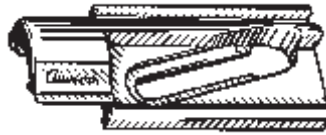

**17151**

(6004036)  
Nylon

Window Reveal Moulding Clip  
Chrysler LeBaron & Maserati  
1987-On

UNIT PACKAGE: 15



**9882**

(C8AZ-63642413-A,  
D1AZ-6542413-B,  
D1AB-6542413-AB)

Windshield & Rear Window Reveal  
Moulding Clip  
Ford 1968-On

UNIT PACKAGE: 100



**9353**

(C6AB-6242413-A)

Rear Window  
Reveal Moulding Clip  
Ford 1967-On

UNIT PACKAGE: 100



**8941**

(C5ZZ-6543413-B)

Windshield &  
Rear Window  
Reveal Moulding Clip  
Ford 1966-On

UNIT PACKAGE: 100



**13564**

(E3SB-6342413-AB)

Windshield & Backlite  
Reveal Moulding Clip  
Ford 1983-On

UNIT PACKAGE: 50



**17290**

(B092-5-609)  
Nylon

Rear Window Moulding Clip  
MX6 1988-On  
Ford Probe 1988-On  
Mercury Tracer 1987-On

UNIT PACKAGE: 15



**10625**

(D0DZ-6203174-C)

Windshield and Rear Window  
Reveal Moulding Clip  
Ford 1969-On

UNIT PACKAGE: 50

**The Auveco FC-1 Flip  
Chart Is A Great  
Selling Tool.  
Use It To Help Boost  
Your Sales.  
Refer To The Color  
Pages At The Front  
Of The Book.**

E-mail Your New  
Product Suggestions To  
[mail@auveco.com](mailto:mail@auveco.com)

**Sec. 17**

**GLASS SHOP SUPPLIES**



**20424**

Not Available From O.E.M.  
White Nylon

Front Door Window Guide  
Overall Length: 1-13/32"  
Buick Electra, Park Ave. & Skylark;  
Chevrolet Malibu; Oldsmobile  
Achieva, Alero, Cutlass &  
98 Regency And Pontiac Grand Am  
1985 - On

UNIT PACKAGE: 5

**19397**

(21098967)  
Nylon

Front & Rear Door  
Window Guide  
Saturn Sedan &  
Wagon  
1996 - On

UNIT PACKAGE: 5

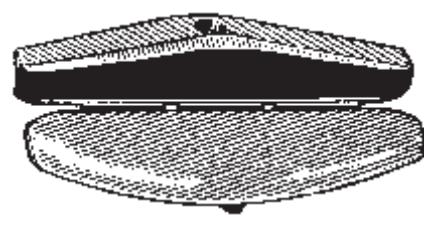
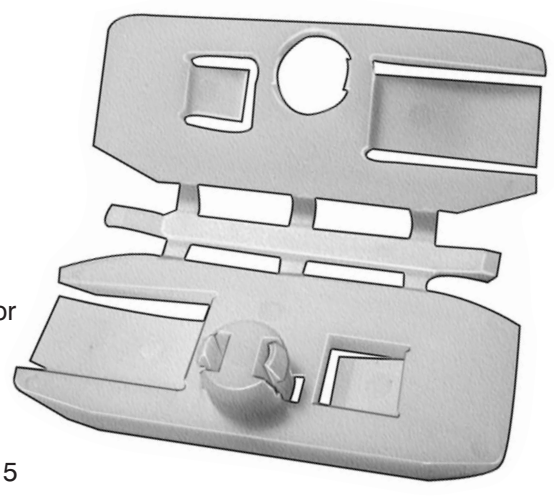

**15462**

(20478733,  
22539533)  
Nylon

Front Door Window Guide  
Rear Of Glass  
Buick Skylark & Somerset 1991-85  
Chevrolet Lumina APV 1990-On  
Olds Calais 1991-85  
Olds Silhouette 1990-On  
Pontiac Grand Am 1991-85  
Pontiac Trans Sport 1990-On

UNIT PACKAGE: 15

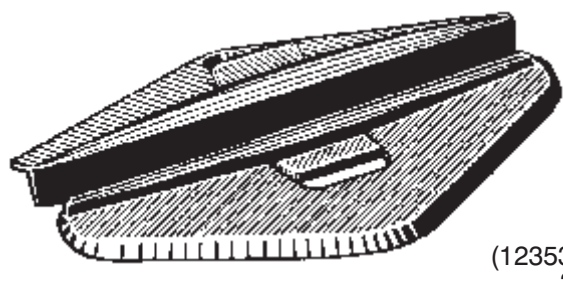

**15463**

(12353912, 20487630,  
20712176)  
Nylon

Front Door Window Guide  
Front Of Glass (4mm Thick)  
Buick Skylark & Somerset 1991-85  
Chevrolet Lumina APV 1990-On  
Olds Calais 1991-85  
Olds Silhouette 1990-On  
Pontiac Grand Am 1991-85  
Pontiac Trans Sport 1990-On

UNIT PACKAGE: 15

***Display Boards  
Are Great Selling Tools.  
Use Them To Help Boost Your Sales.***

***Refer To The Color Pages  
At The Front Of The Catalog.***

# GLASS SHOP SUPPLIES

(ILLUSTRATIONS ACTUAL SIZE)

**Sec. 17**

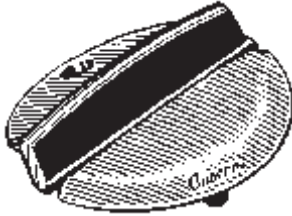

**15464**  
(20477850)  
Nylon

Rear Door Window Guide  
Upper Part Of Glass  
LeSabre & Electra Park Ave. 91-85  
Cadillac Fleetwood & DeVille 93-85  
Delta 88 & 98 Regency 91-85  
Bonneville 1991-87  
UNIT PACKAGE: 15



Not Actual  
Size

**15467**  
(10051034, 20123070, 20328600)  
Nylon

Front & Rear Door Window Guide  
Electra, Estate Wagon, LeSabre &  
Skylark; DeVille; Impala Wagon,  
Caprice & Citation; Delta 88, Custom  
Cruiser, 98 Regency & Omega;  
Catalina, Safari & Phoenix 81-80

UNIT PACKAGE: 25

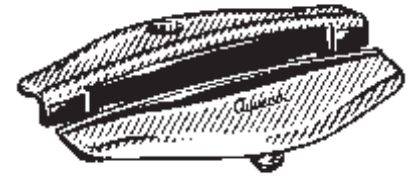

**17176**  
(20162174, 22543363)  
Nylon

Front Door Window Guide  
Buick Skyhawk, Cadillac Cimmaron,  
Chevrolet Cavalier, Olds Firenza &  
Pontiac Sunbird  
1982-On

UNIT PACKAGE: 25

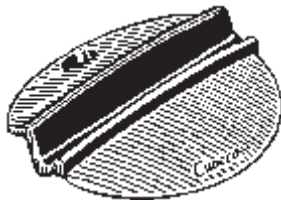

**15465**  
(20345381;  
22539532)  
Nylon

Rear Door Window Guide  
Skyhawk 89-82, Somerset & Skylark  
91-86; Cavalier 82-On; Firenza 88-82,  
Calais 91-86; Sunbird &  
J2000 82-On  
Grand Am 91-86

UNIT PACKAGE: 15

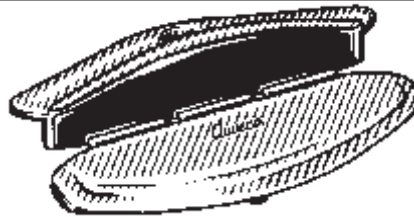

**17159**  
(20747509)  
Nylon

Front Door Window Guide  
Rear Of Glass  
Buick Electra & LeSabre  
Cadillac Fleetwood/DeVil  
Olds Delta & Regency  
Pontiac Bonneville  
1985-On

UNIT PACKAGE: 15

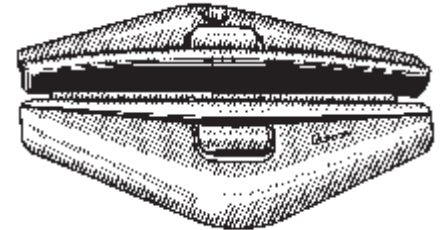

Not Actual  
Size  
**17341**  
(12337898, 20747508)  
Nylon

Front Door Window Guide  
Front Of Glass  
Buick Electra, LeSabre & Park Ave.,  
Cadillac Fleetwood & DeVille, Olds  
88 Royal & 98 Regency, Pontiac  
Bonneville 1985-On

UNIT PACKAGE: 15



**15466**  
(20160591)  
Nylon

Front Door Window Guide  
Upper Part Of Glass  
LeSabre 90-80 & Electra 84-On;  
Fleetwood Brougham &  
DeVil 83-On; Impala &  
Caprice 90-80 &  
Cavalier 87; Delta 88 & Custom  
Cruiser 90-80 & 98 Regency 84-80;  
Parisienne & Safari 89-81 &  
Sunbird 87

UNIT PACKAGE: 25

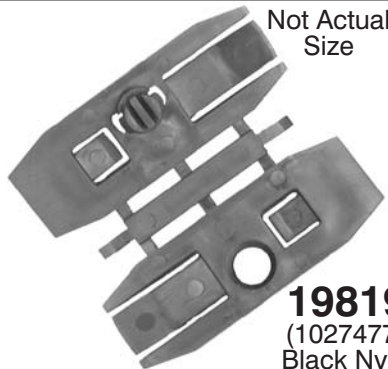

Not Actual  
Size

**19819**  
(10274778)  
Black Nylon

Front Side Door Window Guide  
Chevrolet Venture APV,  
Oldsmobile Silhouette APV,  
Pontiac Montana &  
Trans Sport APV  
1997 - On

UNIT PACKAGE: 10

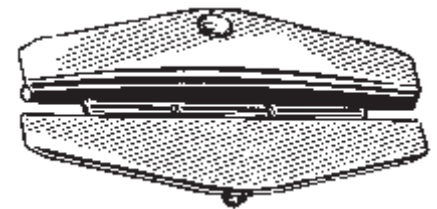

**17455**  
(20493450)  
Nylon

Rear Door Window Guide  
Upper Glass  
Chevrolet Corsica  
1987-On

UNIT PACKAGE: 15

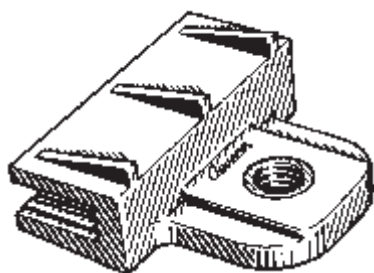

**18113**

(69951-12180)

Nylon With  
Steel Treaded Insert

Glass Mount  
M6-1.0 Thread  
Nissan, Ford & Imports

UNIT PACKAGE: 5

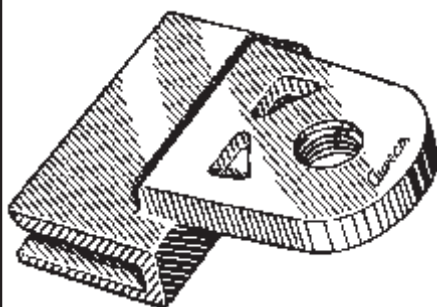

**17479**

Nylon With Steel Threaded Insert

Glass Mount  
M6-1.0 Thread  
Nissan 720 Truck 1986-80

UNIT PACKAGE: 2

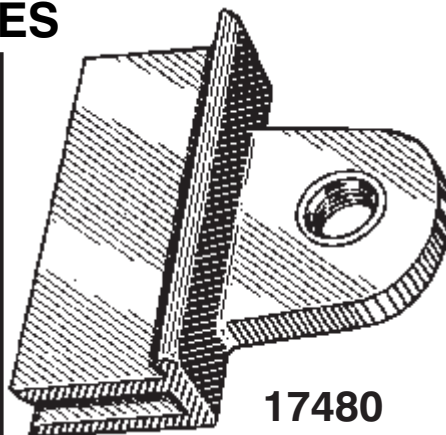

**17480**

Nylon With Steel Threaded Insert

Glass Mount  
M6-1.0 Thread  
Nissan Pathfinder & 850 Pick-Up  
1986 - On

UNIT PACKAGE: 2



**19393**

(F1TZ-17698A)

Rear View Mirror Bracket  
(Windshield Mounted)

NAGS number DW 1256, 1099

1169 & 1170

Fits Ford Mirrors

F0TZ-17700-A

& F7AZ-17700-A on

Ford & L-M Continental,  
Contour, Escort, Mustang, Mystique,  
Sable, Taurus & Tracer  
1991-On

UNIT PACKAGE: 10

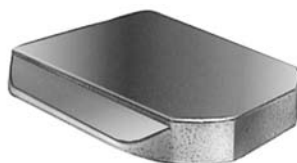

**19394**

(20626174)

Rear View Mirror Bracket  
(Windshield Mounted)

NAGS number 1168, 1191, 1192,

1193, 1194, 1195, 1265,

1288 & 1299

GM

1987-On

UNIT PACKAGE: 10



Not Actual  
Size

**19498**

Black Nylon

Rear View Mirror Adapter Bracket

This adapter bracket allows you to  
reuse the original mirror when a  
windshield is replaced. If the new  
windshield comes with a steel  
mirror button attached, this adapter  
fits over the button. Then the  
original mirror can be fitted  
onto the bracket.

GM & Chrysler  
1981-On

UNIT PACKAGE: 3



**19280**

Black Nylon

Door Window Glass

To Regulator Nut

Ford Contour & Mystique  
1995-On

UNIT PACKAGE: 5

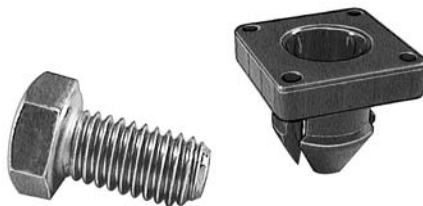

**19281**

(F5RZ-5421416B)

Door Window Glass  
To Regulator Fastener

Assembly

3/8"-16 x 3/4" Grade 8 Cap Screw

Ford Contour & Mystique  
1995-On

UNIT PACKAGE: 2 Sets



**20309**

(5008055AA)

Natural Nylon

Window To Regulator Grommet

Screw Size: #14 (M6.3)

Overall Length: 57mm

Stem Length: 10mm

Fits Into 13mm Hole

Dodge Neon

2000 - On

UNIT PACKAGE: 15

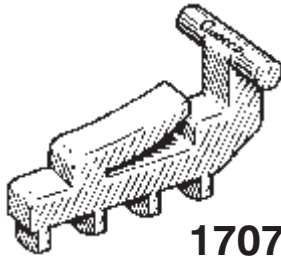

**17073**

(20085729)  
Nylon

Window Regulator Drive Block  
Used With Window  
Regulator Tape  
GM 1980-On

UNIT PACKAGE: 25

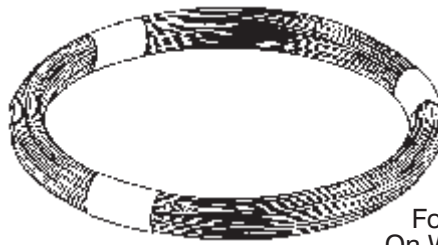

**Piano Wire**

For Cutting Through Sealant  
On Windshields Without Gaskets  
Solid Not Braided Wire

**16959**

1/4 Pound (approx. 160 Ft.)  
.025" Wire Diameter

UNIT PACKAGE: 1 Roll

## Double Blade 3/16" Apart



**14481**

Windshield Knife

This tool features a unique double blade action that is ideal for cutting out urethane around windshields. It features a 3/16" wide blade and a 4-5/8" long machined amber tenite handle.

UNIT PACKAGE: 1

## Window Lift Motor Gear Kits

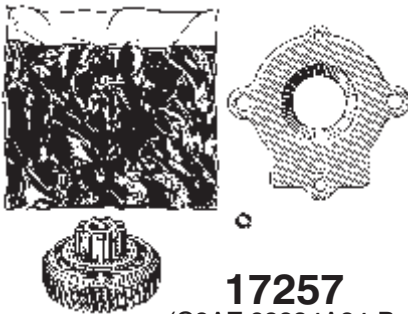

**17257**

(C9AZ-62234A24-B,  
D0AZ-62234A24-B)

45 Spline, 9 Tooth Gear  
Ford 1965-On

UNIT PACKAGE: 1 Kit



**19786**

Not Available From O.E.M.  
Natural Nylon

Torque Pin Kit  
For Window Regulator Gear  
Pin Diameter: 1/2"  
Pin Length: 13/32"  
Ford  
1964 - On

UNIT PACKAGE: 15

Not Actual Size

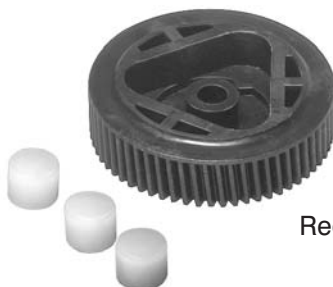

**18947**

Power Window  
Regulator Gear & Rollers  
62 Splines

Ford 1989-On

UNIT PACKAGE: 1

Not Actual Size

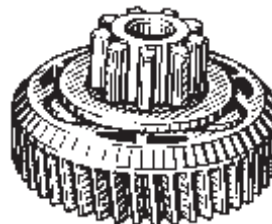

**17974**

(D0AZ-62234A24)  
Power Window  
Regulator Gear  
9 Tooth  
45 Splines  
Ford 1964-On

UNIT PACKAGE: 1

**Sec. 18**

**O.E.M. POWER WINDOW LIFT MOTORS**

Original Equipment

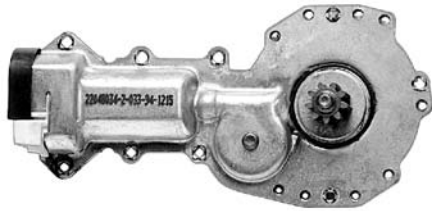

Not Actual Size

**19068**

(9 Tooth Gear)

Astro & Safari 1997-85

UNIT PACKAGE: 1

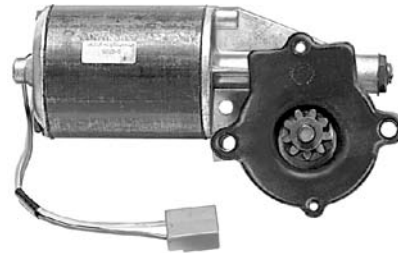

Not Actual Size

**19071**

Lincoln 1981-80  
Lincoln Continental 1987-84  
Lincoln Town Car 1989-82  
Mark Series 1983-80

UNIT PACKAGE: 1



Not Actual Size

**20685**

Aerostar (RH) 1996-86  
Bronco 1996-81  
E100-350 1996-85  
F150-350 1996-80  
Fairmont & Zephyr 1983-78  
Ford & Mercury (Full Size) 1991-65  
Granada (RH) 1982-75  
LTD 1989-83  
Mark Series 1996-84  
Marquis (LH) 1986-83  
Monarch (RH) 1980-75  
Mustang 1996-71  
Ranger (RH) 1990-85  
Sable & Taurus 1993-86  
Tempo & Topaz 1996-84  
T-Bird & Cougar 1991-67  
**Replaces Auveco 19069**

UNIT PACKAGE: 1



Not Actual Size

**20686**

Aerostar (LH) 1996-86  
Bronco 1996-81  
E100-350 1996-85  
F150-350 1996-80  
Fairmont & Zephyr 1983-78  
Ford & Mercury (Full Size) 1991-65  
Granada (LH) 1982-75  
LTD 1989-83  
Mark Series 1996-84  
Marquis (RH) 1986-83  
Monarch (LH) 1980-75  
Mustang 1996-71  
Ranger (LH) 1990-85  
Sable & Taurus 1993-86  
Tempo & Topaz 1996-84  
T-Bird & Cougar 1991-67  
**Replaces Auveco 19070**

UNIT PACKAGE: 1



# Power Window Lift Motor O.E.M. Number Interchange

O.E.M. No.	Auveco No.	O.E.M. No.	Auveco No.
<b>FORD</b>			
DOAZ-5323394-A.....	20685	E8OY-5423394-B .....	20686
DOAZ-5323395-A.....	20686	E8OY-5423395-B .....	20685
DOAZ-5723394-A.....	20685	E8TZ-9823394-A.....	20685
DOAZ-5723395-A.....	20686	E9SZ-6323394-A.....	20685
D2OZ-5323394-A.....	20685	E9SZ-6323395-A.....	20686
D2OZ-5323395-A.....	20686	FO9Z-1123394-A .....	20685
D3AZ-5723394-A .....	20685	F9Z-1123395-A .....	20686
D3AZ-5723394-B .....	20685	F1TZ-1023394-A .....	20685
D3AZ-5723395-A .....	20686	F1TZ-1023395-A .....	20686
D3AZ-5723395-B .....	20686	F1TZ-7823394-A .....	20685
D3AZ-6523394-A .....	20685	F1TZ-7823395-A .....	20686
D3AZ-6523395-A .....	20686		
D3AZ-9823395-A .....	20686	<b>GENERAL MOTORS</b>	
D8TZ-9823394-A.....	20685		
D9BZ-3623394-A .....	20685	22049766.....	19068
D9BZ-3623395-A .....	20686		
D9BZ-5423394-A .....	20685		
D9BZ-5423395-A .....	20686		
E1VY-6623394A .....	19071		
E3AZ-5423394-A.....	20685		
E3AZ-5423395-A.....	20686		
E43Z-5423394-A.....	20685		
E43Z-5423395-A.....	20686		
E5TZ-1023394-A.....	20685		
E5TZ-1023395-A.....	20686		
E7SZ-6323394-A.....	20686		
E7SZ-6323395-A.....	20685		
E7TZ-1023394-A.....	20685		
E7TZ-1023395-A.....	20686		

## HELPFUL HINTS.....

### FOR USING THE Auveco Catalog

- The color-coded pages signify various sections:  
**Blue**-Metric Items  
**Beige**-Electrical Accessories  
**Green**-Assortments, Cabinets, Bins & Racks  
**Gray**-Key Blanks & Accessories  
**Pink**-Import Car Body Hardware
- Most illustrations are actual size. You should be able to set a part on top of the illustration to positively identify it.
- Our Display Boards, which are shown on the four color pages in the front of the catalog, are a great aid in identifying product.
- We have three different indexes in the front of the catalog to assist you.  
**Pictorial Quick Index**  
**Alphabetical Index**  
**Numerical Index**
- There are two OEM Part Number To Auveco Part Number Cross References at the back of the catalog.

**Sec. 18**

**AIR CONDITIONING AND HEATER FAN MOTORS**

Original Equipment



Not Actual Size

**19077**  
(52466047)

With Integral A.C.  
GM Cars 1977-64  
GM Trucks 1990-64

UNIT PACKAGE: 1



Not Actual Size

**19083**  
(F49Z-19805-A)

Ford: Aerostar 1996-86

UNIT PACKAGE: 1



Not Actual Size

**19081**  
(D8UZ-19805-A)

Ford: E100/350 Econoline  
Van 1991-88

UNIT PACKAGE: 1



Not Actual Size

**19080**  
(52466089)

Chevrolet: S, T10 1993-82  
GMC: S15 1993-82  
Oldsmobile: Bravada 1993-91

UNIT PACKAGE: 1



Not Actual Size

**19078**  
(5049604)

Cadillac: Cimarron 1988-87  
Fleetwood Brougham 1992-91  
Chevrolet: Astro 1990-88  
Beretta, Cavalier &  
Corsica 1990-87  
Lumina APV 1992-90  
GMC: Safari 1990-88  
Oldsmobile: Cutlass  
Calais 1990-82  
Firenza 1988  
Silhouette 1993-90  
Pontiac: 6000 1991-89  
Grand Am 1990-89  
Lemans 1990-88  
Sunbird 1990-87

UNIT PACKAGE: 1



Not Actual Size

**19079**  
(22098842)

Chevrolet: Astro 1993-85  
Camber 1988-82  
Corvette 1985-83  
G10-30 1989-78  
GMC: G1500-3500  
Van 1990-78  
Safari 1993-85  
Pontiac: Firebird & Trans Am  
1988-82

UNIT PACKAGE: 1

**All Items  
Are Available  
In Bulk. Call For  
A Quotation.**

# OEM ELECTRIC RADIATOR COOLING FAN MOTORS

## Sec. 18

Original Equipment

Not Actual Size



**19085**  
(22098790)

GM 1993-82

UNIT PACKAGE: 1

Not Actual Size



**19086**

Ford: Escort & Mustang  
1990-87  
LTD 1983  
Tempo 1990-84  
Thunderbird 1988-84

Mercury: Capri 1986  
Cougar 1986-84  
Lynx 1987-86  
Topaz 1990-84  
Tracer 1990-89

UNIT PACKAGE: 1

## MOTOR SPECIFICATION CHART (12 Volts)

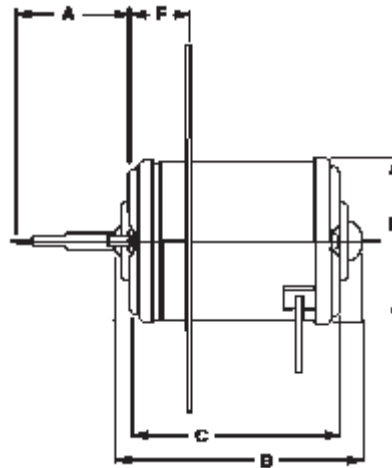
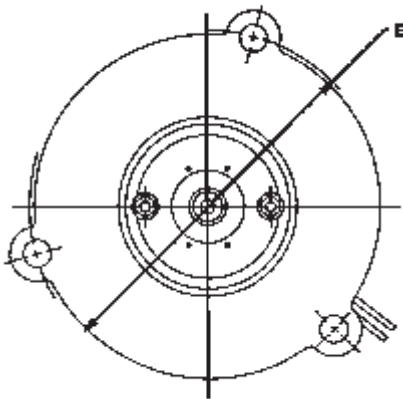

- A = Shaft extension from face
- B = Overall motor length
- C = Case mounting face to mounting face
- D = Outside motor diameter
- E = Mounting hole center to center
- F = Case mounting face to mounting flange

Auveco Part No.	Dia	Shaft Rotation	A	B	C	D	E	F	Motor Type
19077	5/16"	C.W.S.E.	1-3/16"	4-7/8"	4-1/2"	3-3/8"	Varies	13/16"	GM A© Fl. Mtg.
19078	5/16"	C.W.S.E.	1-3/16"	4-1/8"	3-7/8"	3-3/8"	Varies	1-1/4"	GM A© Fl. Mtg.
19079	5/16"	C.W.S.E.	1-1/16"	4-5/8"	3-7/8"	3-3/8"	Varies	1-1/4"	GM A© Fl. Mtg.
19080	5/16"	C.C.W.S.E.	1-1/16"	4-5/8"	3-7/8"	3-3/8"	Varies	1-1/4"	GM A© Fl. Mtg.
19081	5/16"	Reversible	1-7/16"	4-7/16"	3-11/16"	3-1/4"	Varies	13/16"	Ford Heater
19083	5/16"	Reversible	1-7/16"	4"	3-5/16"	3-1/4"	Varies	7/16"	Ford A© Fl. Mtg.
19085	8mm	C.W.S.E.	1/2"	4-1/8"	3-3/8"	3-1/4"	Varies	1-9/16"	GM Rad. Fan
19086	5/16"	Reversible	1"	4-1/2"	3-3/4"	3-1/4"	4-7/8"	7/16"	Ford Rad. Fan Fl. Mtg.

C.W.S.E.-Clockwise Shaft End

C.C.W.S.E.-Counter-Clockwise Shaft End

# Sec. 18

## HORNS

### O.E.M. Replacement Horns



Not Actual Size  
**19017**

Domestic Vehicles  
Low Note

UNIT PACKAGE: 1



Not Actual Size  
**19018**

Domestic Vehicles  
High Note

UNIT PACKAGE: 1



Not Actual Size  
**19019**

Import Vehicles  
Low Note

UNIT PACKAGE: 1



Not Actual Size  
**19020**

Import Vehicles  
High Note

UNIT PACKAGE: 1

Auveco Part No.	Terminals	Frequency (Hz)	Decibel Rating At 4"	Current Draw (Amps)	Power Source (Volts)
<b>19017</b>	one/two	420	125	5	12
<b>19018</b>	one/two	500	125	5	12
<b>19019</b>	one/two	335	130	4	12
<b>19020</b>	one/two	430	130	4	12

### Freeway Blaster Horns ("Big Rig" Sound)



Not Actual Size

**19021**  
Low Note

UNIT PACKAGE: 1



Not Actual Size

**19022**  
High Note

UNIT PACKAGE: 1

Auveco Part No.	Terminals	Frequency (Hz)	Decibel Rating At 4"	Current Draw (Amps)	Power Source (Volts)
<b>19021</b>	one/two	420	130	5	12
<b>19022</b>	one/two	500	130	5	12

### Riviera Air Horns & Compressor Kit



Not Actual Size

**19023**

The Riviera air-powered dual horns sound simultaneously and have the "European" sound. Comes complete with a 12 volt compressor, relay, tubing and mounting hardware.

UNIT PACKAGE: 1 Set



Not Actual Size

**19024**  
Horn Relay  
12 Volt

UNIT PACKAGE: 1

# Horn Application Guide

**Sec. 18**

Year	Make & Model	Original Equipment Replacement	Freeway Blaster (Optional)	Year	Make & Model	Original Equipment Replacement	Freeway Blaster (Optional)
<b>ACURA</b>				<b>LEXUS</b>			
06-90	All Models	*19022 & 19021		06-90	All Models		
<b>AMC</b>				<b>LINCOLN-MERCURY</b>			
90-79	Alliance, Encore, Talon	19019 & 19020	19022 & 19021	06-74	All Other Models	19022 & 19021	
90-74	All Other Models	19018 & 19017	19022 & 19021	99-71	Capri & Capri II	*19020	*19022
<b>AUDI</b>				99-71	Bobcat, Lynx, Zephyr Tracer, Mystique, Topaz	*19018	*19022
06-73	All Models	*19018	*19022	<b>MAZDA</b>			
<b>BMW</b>				06-91	Navajo	19018 & 19017	19022 & 19021
06-95	5, 7, & 9 Models	19018 & 19017	19022 & 19021	06-75	All Other Models	19019 & 19020	19022 & 19021
06-74	All Other Models	19019 & 19020	19022 & 19021	06-71	RX-2, RX-3, Mizer, MX-3, MX-5, Protege, GLC Wagon, B2200, B2601	*19020	*19022
<b>BUICK</b>				<b>MAZDA TRUCK</b>			
06-86	All Other Models	19022 & 19021		06-78	All Models	*19019	*19021
96-75	Skvhawk & Skvlark	*19018	*19022	<b>MERCEDES</b>			
<b>CADILLAC</b>				06-73	All Models	19022 & 19021	
06-75	All Other Models	19022 & 19021		<b>MITSUBISHI</b>			
83-81	Cimarron	*19018	*19022	06-83	All Models	19019 & 19020	19022 & 19021
<b>CHEVROLET</b>				<b>NISSAN</b>			
06-76	Beretta, Cavalier, Celebrity, Chevette, Citation, Corsica, Spectrum, Sprint & Nova	*19018	*19022	06-97	All Models	19018 & 19017	19022 & 19021
06-71	Corvette	19022 & 19021		96-74	All Other Models	19019 & 19020	19022 & 19021
06-71	All Other Models	19018 & 19017	19022 & 19021	90-87	Pulsar	*19020	19022
<b>CHEVROLET LIGHT DUTY TRUCKS &amp; VANS</b>				<b>NISSAN TRUCK</b>			
06-75	S-10	19018 & 19017	19022 & 19021	06-93	Quest	19018 & 19017	19022 & 19021
06-75	All Other Models	19022 & 19021		06-82	All Other Models	19019	*19021
<b>CHRYSLER</b>				<b>OLDSMOBILE</b>			
06-77	All Other Models	19018 & 19017	19022 & 19021	06-91	Bravada	*19017	*19021
97-87	LeBaron & GTS	19018	*19021	04-98	Alero	19018 & 19017	19022 & 19021
<b>DODGE</b>				04-74	All Other Models	19022 & 19021	*19021
06-95	Neon	*79020	*19022	89-88	Firenza	19018	19022
06-74	All Other Models	19018 & 19017	19022 & 19021	<b>PLYMOUTH</b>			
99-87	Charger, Lancer, Omni, Shadow, Spirit	*19018	*19022	03-75	All Other Models	*19018	*19022
96-74	Challenger, Colt	*19020	*19022	89-71	Arrow, Champ, Colt, Laser	*19020	*19022
<b>DODGE LIGHT DUTY TRUCKS &amp; VANS</b>				<b>PLYMOUTH TRUCKS &amp; VANS</b>			
06-87	Dakota, Ram, Pickup, Caravan	*19021		03-74	All Models	*19017	*19021
06-85	All Other Models	19022 & 19021		<b>PONTIAC</b>			
84-75	All Models	19021		06-95	TransSport Montana	19018 & 19017	19022 & 19021
<b>FORD</b>				06-75	All Other Models	19018 & 19017	19022 & 19021
06-71	Escort, Fairmont, Festiva, Maverick, Mustang II, Pinto, Tempo, Contour	*19018	*19022	94-93	TransSport	*19017	*19021
06-70	All Other Models	19022 & 19021		94-82	Astre, J-2000, T-1000, Lemans, Sunbird	19019	*19021
81-77	Fiesta	19020	19022	87-84	Fiero	19019 & 19020	19022 & 19021
<b>FORD LIGHT DUTY TRUCKS &amp; VANS</b>				<b>PORSCHE</b>			
06-85	All Other Models	19022 & 19021		06-70	All Models	19018 & 19017	19022 & 19021
90-75	Ranger, E 150/350 Vans, Aerostar, Economize	*19022		<b>RANGE ROVER</b>			
<b>GEO</b>				06-01	All Models	19022 & 19021	
99-90	All Other Models	*19019	*19021	<b>SAAB</b>			
93-90	Storm	19019 & 19020	19022 & 19021	06-79	All Models	19019 & 19020	19022 & 19021
<b>GMC LIGHT DUTY TRUCKS &amp; VANS</b>				<b>SATURN</b>			
06-75	All Other Models	19018 & 19017	19022 & 19021	06-90	All Models	*19019	*19021
92-91	Jimmy, Sonoma	*19021		<b>SUBARU</b>			
<b>HONDA</b>				94-87	Justy, Samurai	*19019	*19021
06-80	Civic, Civic Del Sol	*19020	*19022	<b>SUZUKI SUV</b>			
06-73	All Other Models	19019 & 19020	19022 & 19021	06-88	All Models	*19019	*19021
<b>HYUNDAI</b>				<b>TOYOTA</b>			
06-86	All Other Models	19019 & 19020	19022 & 19021	06-91	Avalon, Camry	19018 & 19017	19022 & 19021
87-84	Pony	19020	19022	06-80	Starlet, Tercel Sedan, Corolla Coupe, Sedan, Liftback	*1900	*19022
<b>INFINITI</b>				06-72	All Other Models	19018 & 19017	19022 & 19021
06-90	All Models	19022 & 19021		<b>TOYOTA TRUCK</b>			
<b>ISUZU</b>				06-81	Land Cruiser & Other Models	19022 & 19021	
06-83	Impulse, Stylus, Trooper	19019 & 19020	19022 & 19021	06-70	4-Runner, Pickup, Van, Paseo	*19020	*19022
06-81	I Mark, Amigo, Pickup, Rodeo	*19020	*19022	80-69	Land Cruiser	*19020	*19022
<b>JAGUAR</b>				<b>VOLKSWAGEN</b>			
06-72	All Models	19022	19021	06-80	Jetta, Quantum, Fox, Golf, Passat	19019 & 19020	19022 & 19021
<b>JEEP</b>				06-74	All Other Models	*19019	*19021
01-74	Cherokee, Grand Cherokee	19022 & 19021		<b>VOLVO</b>			
01-70	CJ, DJ, Scrambler, Wrangler	*19018	*19022	06-70	All Other Models	19019 & 19020	19022 & 19021
				97-84	240-740-760 Series	*19020	*19022

\*One horn is standard; however, vehicle may be equipped with optional second horn for better sound. Add another horn of opposite note (high or low).

**Sec. 19**

**TRIMMING SUNDRIES & FASTENERS**

(ILLUSTRATIONS ACTUAL SIZE)



**1720**

Door And Quarter Trim  
Panel Fastener.  
Chrysler

UNIT PACKAGE: 100



**8206**

Door Trim  
Panel Fastener:  
Ford

UNIT PACKAGE: 100



**2272**

(358107)

Body Belt Moulding &  
Hood Side Moulding Fastener:  
Ford

UNIT PACKAGE: 100



**2385**

Door Trim  
Panel Fastener:  
Chrysler

UNIT PACKAGE: 100



**2310**

Door Trim  
Panel Fastener  
Chrysler

UNIT PACKAGE: 100



**2309**

Door Trim Panel Fastener:  
All Cars With .125 Panels  
Ford

UNIT PACKAGE: 100



**11863**

(383033-S101)  
Phosphate

Door Trim  
Panel Fastener  
Ford

UNIT PACKAGE: 50

**10780**

Same As 11863 Except  
For Packing

UNIT PACKAGE: 100

Remember...  
All Items In This  
Catalog  
Are Available In Bulk.  
Call For A Quote.



**808**

General Purpose:  
Chrysler

UNIT PACKAGE: 100



**807**

General Purpose:  
Chrysler

UNIT PACKAGE: 100



**1256**

(353123)

Rear Quarter Strip  
(Inside), Instrument  
Panel Moulding & Hood  
Side Moulding Fastener  
Ford & Chrysler

UNIT PACKAGE: 50



**20302**

Cowl To Pillar  
Fastener & Door Trim Panel  
Fastener.  
Chrysler

UNIT PACKAGE: 50



**9361**

(Ford: 358470;  
Chry: 1900654)

Door Trim Panel Fastener:  
Ford & Chrysler

UNIT PACKAGE: 100

E-mail Your New  
Product Suggestions  
To [mail@auveco.com](mailto:mail@auveco.com)

# TRIMMING SUNDRIES & FASTENERS

# Sec. 19

(ILLUSTRATIONS ACTUAL SIZE)

 <p><b>11406</b> Trim Clip Fastener Head Diameter 1/2" For 1/4" Hole UNIT PACKAGE: 100</p>	 <p><b>11408</b> Trim Clip Fastener: Head Diameter 1/2" For 5/16" Hole UNIT PACKAGE: 100</p>	 <p><b>11410</b> Trim Clip Fastener: Head Diameter 7/16" For 1/4" Hole UNIT PACKAGE: 100</p>	
 <p><b>11407</b> Trim Clip Fastener: Head Diameter 9/16" For 5/16" Hole UNIT PACKAGE: 100</p>	 <p><b>11409</b> Trim Clip Fastener: Head Diameter 1/2" For 5/16" Hole UNIT PACKAGE: 100</p>	 <p><b>11411</b> Trim Clip Fastener: Head Diameter 15/32" For 3/16" Hole UNIT PACKAGE: 100</p>	
 <p><b>18351</b> Phosphate &amp; Olive Drab Weatherstrip Clip Ford UNIT PACKAGE: 50</p>	 <p><b>18402</b> Phosphate &amp; Green Weatherstrip Clip GM UNIT PACKAGE: 25</p>	 <p><b>18352</b> Black Phosphate Weatherstrip Clip GM UNIT PACKAGE: 25</p>	 <p><b>18395</b> Black Phosphate Weatherstrip Clip GM UNIT PACKAGE: 50</p>
 <p><b>18775</b> Black Phosphate Inner Window Felt Clip GM UNIT PACKAGE: 25</p>	 <p><b>12134</b> (4114785) Zinc Trim Panel Fastener Fits Into 5/16" Hole Chrysler UNIT PACKAGE: 50</p>	 <p><b>19437</b> (6031551) Red Oxide Trim Panel Retainer Chrysler Van 1997-On UNIT PACKAGE: 25</p>	
<p><b>2279</b> Aluminum Cap</p>  <p>A: 15/32" B: 3/4" C: 1/4" D: 3/8"</p> <p>General Purpose UNIT PACKAGE: 100</p>		<p><b>2280</b> Gray</p>  <p>A: 15/32" B: 3/4" C: 1/4" D: 3/8"</p> <p>General Purpose UNIT PACKAGE: 100</p>	

# Sec. 19

# TRIMMING SUNDRIES & FASTENERS

(ILLUSTRATIONS ACTUAL SIZE)



**1117**

Brown Japan

General Purpose  
Head Diameter: 17/32"  
Prong Length: 3/4"  
Prong Width: 7/16"

UNIT PACKAGE: 100



**1202**

Brown

General Purpose  
Head Diameter: 17/32"  
Prong Length: 1"  
Prong Width: 15/32"

UNIT PACKAGE: 100



**3445**

(4653672)

Black Japan  
Door Flange Weatherstrip  
Fastener  
GM Cars 1960-46

A: 13/32"  
B: 35/64"  
C: 9/64"  
D: 11/64"

UNIT PACKAGE: 50



**18397**

(4654974)

Polished Stainless  
Steel Cap

Trim Pad Fastener  
Head Diameter: 5/8"  
Prong Length: 1-1/4"  
GM

UNIT PACKAGE: 25

## BULK QUANTITIES



A 13/32"  
B 35/64"  
C 9/64"  
D 11/64"

Auveco  
Part No. Color

**3445\*** Black



A 15/32"  
B 3/4"  
C 1/4"  
D 3/8"  
E

Auveco  
Part No. Color

**2280•** Gray  
**2279•** Aluminum

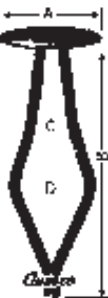

A 17/32"  
B 7/8"  
C 9/32"  
D 1/2"

Auveco  
Part No. Color

**5961•** Brown

A "Head Size"  
B "Overall Length"  
C "Hole Size"  
D "Width of Diamond"

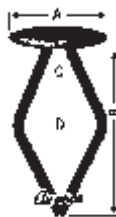

A 17/32"  
B 3/4"  
C 9/32"  
D 7/16"

Auveco  
Part No. Color

**1117•** Brown

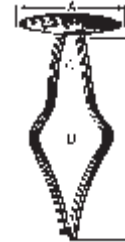

A 17/32"  
B 1"  
C 1/4"  
D 7/16"  
U

Auveco  
Part No. Color

**1202•** Brown

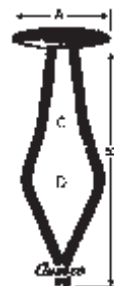

A 17/32"  
B 1-17/64"  
C 9/32"  
D 7/16"

Auveco  
Part No. Color

**5984•** Brown

All Parts on This Page are Available in Bulk quantities of 25,000 or More-Quotation on Request.

\* Available In Unit Package of 50 Pieces

• Available In Unit Package of 100 Pieces



# TRIMMING SUNDRIES & FASTENERS

Sec. 19

(ILLUSTRATIONS ACTUAL SIZE)



**9921**

(4851794)

1-1/8" Diameter  
Seat Back Button Retainer  
GM 1962-On

UNIT PACKAGE: 25



**19806**

(330485)

Door Lock Rod Ferrule  
13/16" O.D.  
Polished Stainless Steel  
With Felt Insert  
**Replaces Auveco 11415**  
GM Trucks 1975-On

UNIT PACKAGE: 25



**11417**

(1703469, 12338035)

Door Lock Rod Ferrule  
1-1/32" O.D.  
Polished Stainless Steel  
With Felt Insert  
GM 1977-On

UNIT PACKAGE: 10



**12670**

7/16" Nail  
(.460)

Replaces 7585  
"Nail On" Door Panel Repair Clip  
Slips On Door Panel Fastener Strip  
For Repairs To Replace Broken  
Nails In Panel Edging.  
GM

UNIT PACKAGE: 50



**12671**

3/4" Nail  
(.750)

Replaces 7585  
"Nail On" Door Panel Repair Clip  
Slips On Door Panel Fastener Strip  
For Repairs To Replace Broken  
Nails In Panel Edging.  
GM

UNIT PACKAGE: 50



Display Boards  
Are Great Selling Tools.  
Use Them To Help  
Boost Your Sales.  
Refer To The  
Color Pages  
At The Front Of The Catalog.

**Sec. 19**

**TRIMMING SUNDRIES & FASTENERS**

(ILLUSTRATIONS ACTUAL SIZE)



**7185**  
Nickel Plated Brass

Welt Tip  
I.D.: 9/16", Height: 1/4"

UNIT PACKAGE: 100

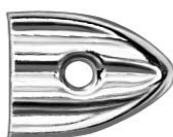

**7181**  
Nickel Plated Brass

Welt Tip  
I.D.: 11/16", Height: 3/16"

UNIT PACKAGE: 100



**7875**  
Nickel Plated Brass

Welt Tip  
I.D.: 5/8", Height: 3/16"  
All Convertibles

UNIT PACKAGE: 100



**V-875**  
Fender Welt

1-3/8 inch (3/16" Bead)  
Bright Smooth Vinyl Bead

UNIT PACKAGE: 50 FEET



**Footman Loops**

Auveco Part No.	Size	Hole Size	Hole Ctr. To Hole Ctr.	Overall Length	Unit Pkg.
<b>Steel-Nickel Plated</b>					
7771	For 1" Strap	7/32"	2-1/8"	2-5/8"	25
7772	For 1-1/4" Strap	1/4"	2-1/4"	2-3/4"	25
7773	For 1-1/2" Strap	1/4"	2-5/8"	3-1/8"	25
19401	For 2" Strap	1/4"	3-1/8"	3-21/32"	25
<b>300 Series Stainless Steel</b>					
18490	For 1-1/4" Strap	1/4"	2-5/8"	3-3/32"	10
<b>Steel - Black "E" - Coat Plated (168 Hrs. Salt Spray)</b>					
19402	For 1" Strap	7/32"	2-1/8"	2-5/8"	25
19403	For 1-1/4" Strap	1/4"	2-1/4"	2-3/4"	25
19404	For 1-1/2" Strap	1/4"	2-5/8"	3-1/8"	25
<b>Steel - Zinc Plated</b>					
19848	For 2" Strap	1/4"	3-1/8"	3-21/32"	25

**Hog Rings**



**7595**

Medium  
.080" Wire Dia.

To attach seat covers to cushions  
and seat bottoms - also cushion spring clips

UNIT PACKAGE: 500 (One Size)



**7644**

Large  
.088" Wire Dia.

# TRIMMING SUNDRIES & FASTENERS

**Sec. 19**

(ILLUSTRATIONS ACTUAL SIZE)



**12069**  
(416629)  
Zinc

Upholstery Clips  
GM 1979-On

UNIT PACKAGE: 50



**7707**

Cloth Lined  
Cushion Spring Clip  
To Fasten Springs To Each Other  
Or To Border Wire. 7/8" Long. For  
1/4" Or Two 8 Gauge Wires.

UNIT PACKAGE: 100



**11421**  
Zinc

Seat Cover Clip

UNIT PACKAGE: 100



**2392**

Seat Cover  
Elastic Cord  
Wire Hook

UNIT PACKAGE: 500



**9417**

Snap-On Trim Clip  
Panel Range: .105"-.115"

UNIT PACKAGE: 100



**7530**

Cushion Spring Clip  
to Fasten Springs To Each Other  
or To Border Wire. 1/2" x 1/2"

UNIT PACKAGE: 100



**2850**

Front Seat  
Self-Locking Clip  
Ford

UNIT PACKAGE: 100



**9416**

Snap-On Trim Clip  
Panel Range: .060"-.090"

UNIT PACKAGE: 100



**Cushion Edge Wire Ferrules**

2-1/2" Long

**7533** For No. 9 Wire.

UNIT PACKAGE: 100 (ONE SIZE)



**8665**

Front Seat  
Rod End Nut:  
O.D. 15/16"  
Stud Size 1/2"  
Chrysler

UNIT PACKAGE: 100



**7578**

Seat Cushion Upholstery Clip  
Can be used to repair  
drooping headliners in Honda.

UNIT PACKAGE: 500



**11795**

Zinc

Seat Cover Clip  
GM 1978-On

UNIT PACKAGE: 100



**8719**

(4000155)  
Nickel

Front Seat Inner Bracket Nut  
O.D.: 11/16", Stud Size: 3/8"  
Rambler

UNIT PACKAGE: 100



**2672**

Front Seat  
Hinge Arm Clip  
GM

UNIT PACKAGE: 100

**Sec. 19**

**TRIMMING SUNDRIES & FASTENERS**

(ILLUSTRATIONS ACTUAL SIZE)



**Grommets And Washers  
Solid Brass**

<b>7345</b> .....	1/4" Hole	.....	(Size No. 0)
<b>7346</b> .....	9/32" Hole	.....	(Size No. 1)
<b>7347</b> .....	3/8" Hole	.....	(Size No. 2)
<b>7348</b> .....	7/16" Hole	.....	(Size No. 3)
<b>7349</b> .....	1/2" Hole	.....	(Size No. 4)
<b>7350</b> .....	5/8" Hole	.....	(Size No. 5)

NOTE: Washers placed in a bag separate from grommets.

UNIT PACKAGE: 144 Grommets & 144 Washers

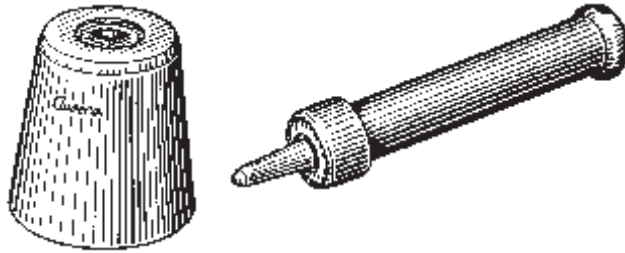

**Grommet Setting Dies**

<b>7339</b> -For Grommet 7345	(1/4" Hole-Size No. 0)
<b>7340</b> -For Grommet 7346	(9/32" Hole-Size No. 1)
<b>7341</b> -For Grommet 7347	(3/8" Hole-Size No. 2)
<b>7342</b> -For Grommet 7348	(7/16" Hole-Size No. 3)
<b>7343</b> -For Grommet 7349	(1/2" Hole-Size No. 4)
<b>7344</b> -For Grommet 7350	(5/8" Hole-Size No. 5)

UNIT PACKAGE ONE SET

**Countersunk Type Washers**



Screw Size	I.D.	O.D.	Nickel Plated Brass			Black Zinc		Plain Brass	
			Unit Pkg. 100	Unit Pkg. 144	Unit Pkg. 1000	Plated Part No.	Brass Unit Pkg.	Part No.	Unit Pkg.
#4.....	9/64"	3/8"	<b>612</b>		<b>7613</b>			<b>16590</b>	100
#6.....	11/64"	7/16"	<b>614</b>	<b>7143</b>	<b>7615</b>	<b>16011</b>	100		100
#8.....	13/64"	1/2"	<b>616</b>	<b>7145</b>	<b>7616</b>	<b>16012</b>	100	<b>16592</b>	100
#10.....	1/4"	19/32"	<b>618</b>	<b>7147</b>	<b>7618</b>	<b>16013</b>	100	<b>16593</b>	100
#12.....	9/32"	11/16"	<b>619</b>	<b>7148</b>				<b>16594</b>	100
#14.....	5/16"	25/32"	<b>620</b>	<b>7149</b>	<b>7620</b>				

**Flanged Type  
Countersunk Washers**



Screw Size	I.D.	O.D.	Nickel On Brass Part No.	Black Zinc On Brass Part No.	Stainless Steel Part No.	Unit Pkg.
#6.....	5/32"	1/2"	<b>3469</b>		<b>3470</b>	100
#8.....	13/64"	5/8"	<b>2515</b>	<b>16009</b>	<b>2597</b>	100
#10.....	1/4"	11/16"	<b>3471</b>	<b>16010</b>	<b>3472</b>	100

**Flush Type Washers  
Nickel Plated On Brass**



Unit Pkg. 100	Unit Pkg. 144	Unit Pkg. 1000	Screw Size	I.D.	O.D.
<b>602</b> .....	<b>7137</b> .....	<b>7624</b> .....	#6	5/32"	11/32"
<b>604</b> .....	<b>7138</b> .....	<b>7625</b> .....	#8	3/16"	3/8"
<b>16015</b> .....	<b>16016</b> .....	<b>16016</b> .....	#10	13/64"	15/32"

# TRIMMING SUNDRIES & FASTENERS

**Sec. 19**

(ILLUSTRATIONS ACTUAL SIZE)

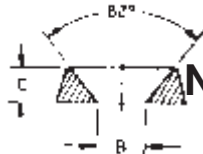
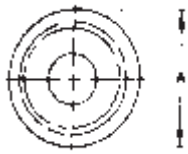

## Nylon Finishing Washers



Available in natural or black nylon, these molded washers protect cabinets from scratching, cover misaligned holes, etc. May also be used as guides, bumpers and spacers.

Auveco Part No.	Screw Size	O.D. (A)	I.D. (B)	Thickness (C)	Color	Unit Pkg.
13717	#6	.437"(11.10mm)	.143"(3.63mm)	.100"(2.54mm)	Black	50
13718	#8	.515"(13.08mm)	.171"(4.34mm)	.115"(2.92mm)	Natural	50
13719	#8	.515"(13.08mm)	.171"(4.34mm)	.115"(2.92mm)	Black	50
13720	#10	.580"(14.73mm)	.191"(4.85mm)	.152"(3.86mm)	Natural	50
13721	#10	.580"(14.73mm)	.191"(4.85mm)	.152"(3.86mm)	Black	50
13722	#12	.609"(15.47mm)	.225"(5.72mm)	.160"(4.06mm)	Natural	50
13723	#12	.609"(15.47mm)	.225"(5.72mm)	.160"(4.06mm)	Black	50
13724	#14	.683"(17.35mm)	.251"(6.38mm)	.183"(4.65mm)	Natural	50
13725	#14	.683"(17.35mm)	.251"(6.38mm)	.183"(4.65mm)	Black	50

## Pop on Screw Covers & Bases



Covers-Matte Finish

Ultra Violet Stabilized Polypropylene covers and bases help shield screws from corrosive environments. Their smooth finish forms a protective barrier against rough-edges.

For use with flat head and oval head tapping screws and round head machine screws.

**They're simple to use:**

1. Place washer over pilot or starting hole for screw, nail or rivet.
2. Install fastener
3. Place Snap Cap over washer At slight angle.
4. Simply push Snap Cap down firmly.

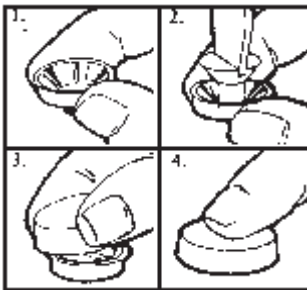

Screw Cover Bases			Screw Covers		
Auveco Part No.	Unit Pkg.	Screw Size	Auveco Part No.	Unit Pkg.	Color
13839	50	#4	13831*	50	Black
			13832*	50	White
13840	50	#6	13833*	50	Black
			13834*	50	White
13841	50	#8	13835•	50	Black
			13836•	50	White
13842	50	#10	13837•	50	Black
			13838•	50	White

\* 1/2" O.D.

• 5/8" O.D.

## Accessories For Use On Landau Tops



**19413**

(F7UZ-15238A32)  
Black Nylon

Door Panel Screw Cover  
Head Diameter: 3/4"  
(19mm)  
Fits Into 5/8" (16mm) Hole  
Ford Economize E150  
1997-On

UNIT PACKAGE: 25



**9877**

Stainless Steel

#4-24 x 3/8"  
7/32" Head Diameter  
Type AB

Used In Place Of  
Welded Studs  
On Landau Tops.

UNIT PACKAGE: 100



**9850**

(7731589)  
Blue Nylon

Landau Top Moulding Clip  
Use With Auveco Screw  
9877

UNIT PACKAGE: 100



**10632**

Black Nylon

Landau Top Moulding Clip  
Use With Auveco  
Screw 9877  
Same as 9850 Only Black.

UNIT PACKAGE: 100

**Sec. 19**

**TRIMMING SUNDRIES & FASTENERS**



**18398**  
(20058837)  
Nylon

Windshield Upper  
Garnish Clip  
GM A & G Models  
1988-78

UNIT PACKAGE: 10

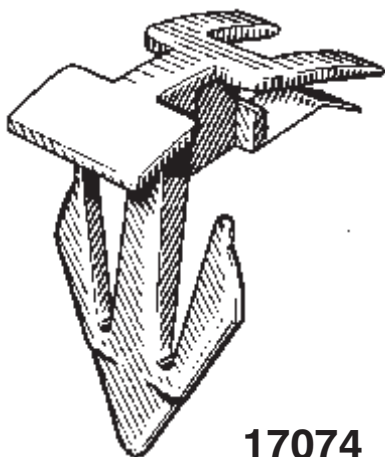

**17074**  
(20007308)  
Nylon

Windshield & Back  
Window Garnish Clip  
Buick Electra & LeSabre;  
Cadillac DeVille & Fleetwood;  
Chevrolet Caprice & Impala;  
Oldsmobile 88 & 98 and  
Pontiac Bonneville 1984-77

UNIT PACKAGE: 25



**16865**  
(20462090)  
Nylon

Garnish Moulding Clip  
Buick Century & Regal,  
Chevrolet Camber, Celebrity,  
Monte Carlo & Malibu, Oldsmobile  
Cutlass & Ciera, Pontiac Firebird  
Grand Prix & 6000 1978-On

UNIT PACKAGE: 25

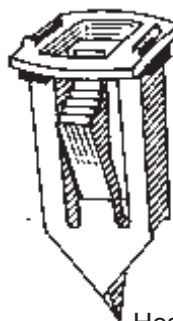

**11118**  
(9617200)  
Nylon

Headliner Clip  
Inner Side Front, Center & Rear  
GM 1973-On

UNIT PACKAGE: 10

**11119**

Same As 11118  
Except For Packing  
UNIT PACKAGE: 100

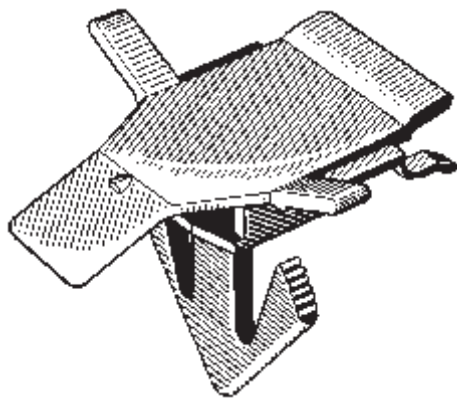

**18399**  
(20095324)  
Nylon

Back Window Upper Garnish  
Moulding Clip  
GM (Exc. Cadillac)  
1988-78

UNIT PACKAGE: 10

Do You Want Your  
Customers To Know  
You Use The Best  
Body Hardware &  
Specialty Fasteners  
Available?

Promotional Products  
And Apparel Bearing

The  Logo  
Promote Your Identity  
As A Professional.

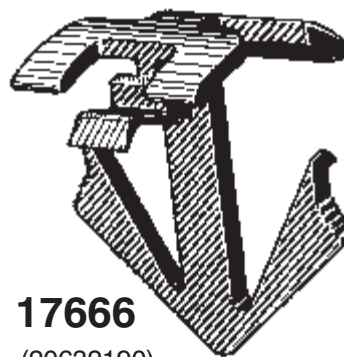

**17666**  
(20632190)  
Nylon

Garnish Moulding Clip  
Back Window Upper & Side  
Moulding Garnish  
Buick LeSabre, Cadillac Fleetwood  
Brougham, Chevrolet Caprice &  
Impala, Olds Delta 88 & 98, Pontiac  
Bonneville & Parisienne  
1989-80

UNIT PACKAGE: 10

# TRIMMING SUNDRIES & FASTENERS

**Sec. 19**

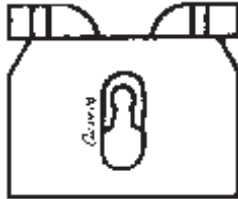

**11481**  
(1731225)  
Nylon

Roof Transverse  
Moulding Clip  
GM 1976-On  
UNIT PACKAGE: 25

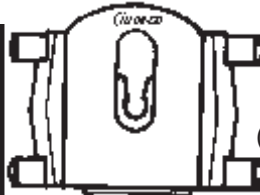

**11485**  
(1729250)  
Nylon

Roof Transverse Moulding Clip  
GM 1976-On  
UNIT PACKAGE: 25



**9342**  
(4459049)  
Nylon

Door Trim Pad  
Grommet  
Buick & Oldsmobile  
UNIT PACKAGE: 50



**3617**  
(6280765)  
Nylon

Door Trim Pad  
Grommet  
Chevrolet &  
Oldsmobile  
UNIT PACKAGE: 100

## SNAP FASTENERS



Button  
Nickel on Brass  
1 1/64" Barrel Length

**14830** - Black Delrin Cap  
UNIT PACKAGE: 50  
**7677** - Nickel Cap  
UNIT PACKAGE: 100



Socket  
Nickel on Brass

**7678** - Normal Action  
UNIT PACKAGE: 100



Stud  
Nickel on Brass

**7679** - Clinch Type  
UNIT PACKAGE: 100



Eyelet  
Nickel on Brass

**7682** - 1/4" Barrel Length  
UNIT PACKAGE: 100

Buttons 7677 and 14830 assemble with socket 7678. You can use hand tools 7690 and 7691 or handpress tool 14835 to complete this step. Stud 7679 assembles with eyelet 7682. You can use hand tools 7691 and 7692 or handpress tool 14835 to perform this step. The two assembled units then snap together. Also an assembled button (7677, 14830) and socket (7678) unit can be used with fasteners listed below.



Machine Screw  
Nickel on Brass

**7681** 10-32" x 3/8"  
UNIT PACKAGE: 100



Phillips Wood Screw  
Nickel on Brass

**9814** #8 x 3/8"  
**7680** #8 x 5/8"  
UNIT PACKAGE: 100



Phillips Head  
Stainless Steel Screw

**14833** #8 x 3/8"  
**14834** #8 x 5/8"  
**15687** #10 x 5/8"  
UNIT PACKAGE: 50



Phillips Head  
Nickel on Brass

**16418** #8 x 1/2"  
**16419** #8 x 3/4"  
Stainless Steel Screw  
UNIT PACKAGE: 25



Socket  
Nickel on Brass

**7683** 7/32" Prongs. Assembles  
with clinch plate 7684.  
Snaps together with 7688.  
UNIT PACKAGE: 100



Clinch Plate  
Nickel on Brass

**7684** Assembles with  
socket 7683.  
UNIT PACKAGE: 100



Wood Screw Stud  
Nickel on Brass

**7688** #7 x 1/2" snaps  
together with  
socket 7683.  
UNIT PACKAGE: 100

**Sec. 19**

**SNAP FASTENERS**

**7690**

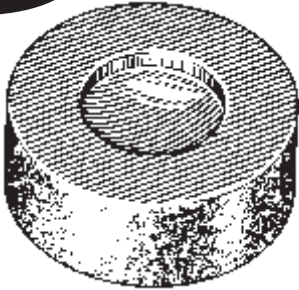

Die for assembling buttons 7677 & 14830 with socket 7678. The button sets in the die. Then the material and socket are placed over the button barrel. Tool 7691 is used to swedge over the barrel. 5/8" high, 1-3/8" diameter.

UNIT PACKAGE: 1

**7692**

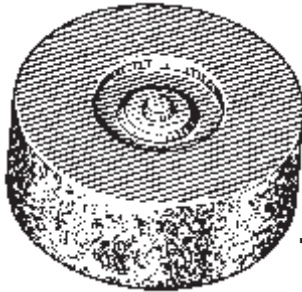

Die for assembling stud 7679 and eyelet 7682. The eyelet sets in the die. Then the material and stud are placed over the eyelet barrel. Tool 7691 is used to swedge over the barrel. 5/8" high, 1-3/8" diameter.

UNIT PACKAGE: 1

**7691**



Tool for assembling buttons 7677 & 14830 with socket 7678 and stud 7679 with eyelet 7682. 3-1/4" long.

UNIT PACKAGE: 1

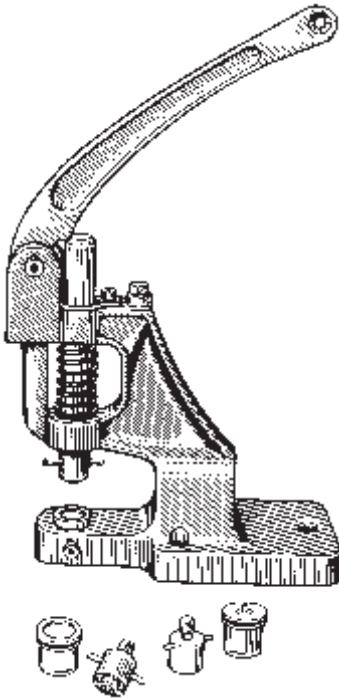

**14835**

Handpress tool for professional looking assembly of buttons 7677 & 14830 with socket 7678 and stud 7679 with eyelet 7682. Tool automatically punctures material. Buttons and eyelet sit on bottom dies. Socket and stud snap onto dies on the plunger. 13-1/2" x 8" x 3-1/2". Weighs 8 lbs.

UNIT PACKAGE: 1

Do You Want Your Customers To Know  
You Use The Best Body Hardware & Specialty Fasteners Available?







Promotional Products

And Apparel Bearing The  Logo

Promote Your Identity  
As A Professional.

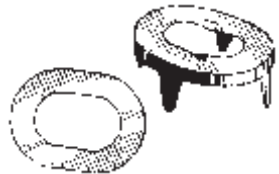

## Curtain Fasteners Nickel On Brass

 <p>Backplate</p> <p><b>7417</b> Single curtain to clinch with backplate</p> <p>UNIT PACKAGE: 100</p>	 <p>Backplate</p> <p><b>7418</b> Double curtain to clinch with backplate</p> <p>UNIT PACKAGE: 100</p>	 <p><b>7419</b> Single curtain. Use with #4 stainless steel or chrome or brass screws (sold separately).</p> <p>UNIT PACKAGE: 100</p>	 <p><b>7420</b> Double curtain. Use with #4 stainless steel or chrome on brass screws (sold separately).</p> <p>UNIT PACKAGE: 100</p>
 <p><b>7423</b> Double Curtain. Solid Screw Base. #8 x 5/8" Screw</p> <p>UNIT PACKAGE: 100</p>	 <p><b>7409</b> Eyelets &amp; washers. Use with 7417 thru 7423 Fasteners.</p> <p>UNIT PACKAGE: 100 Sets</p>	 <p><b>7432</b> Tool for cutting holes in material when installing 7409 eyelet and washer. 4" long.</p> <p>UNIT PACKAGE: 1</p>	

### HELPFUL HINTS.....

### FOR USING THE Auveco CATALOG

- The color-coded pages signify various sections:
  - Blue**-Metric Items
  - Beige**-Electrical Accessories
  - Green**-Assortments, Cabinets, Bins & Racks
  - Gray**-Key Blanks & Accessories
  - Pink**-Import Car Body Hardware
- Most illustrations are actual size. You should be able to set a part on top of the illustration to positively identify it.
- Our Display Boards, which are shown on the four color pages in the front of the catalog, are a great aid in identifying product.
- We have three different indexes in the front of the catalog to assist you.
  - Pictorial Quick Index**
  - Alphabetical Index**
  - Numerical Index**
- There are two OEM Part Number To Auveco Part Number Cross References at the back of the catalog.

# Sec. 19

# TRIMMING SUNDRIES & FASTENERS

Refer to Retainer Specification Chart on pages 381 - 387.



**18684**  
(10262036)  
Black Nylon

Control Panel Trim Retainer  
Chevrolet Lumina &  
Monte Carlo 1995-On

UNIT PACKAGE: 100



**18683**  
(10063599)  
Black Nylon

Remote Control Door  
Lock Receiver Retainer  
Chevrolet Lumina  
& Monte Carlo, Oldsmobile  
Cutlass And Pontiac  
Bonneville & Grand Prix  
1991-On

UNIT PACKAGE: 100



**18770**  
(3759944)  
Black Nylon

Cowl & Dash Panel  
Retainer  
Dodge Shadow &  
Plymouth Sundance  
1988-On

UNIT PACKAGE: 50



**20165**  
(4658887)  
Black Nylon

Trim Panel Retainer  
Chrysler LH & LHS Series  
1997 - On

UNIT PACKAGE: 50



**20528**  
(24205245)  
Black Nylon

Rear Bumper Cover  
Retainer  
Chevrolet Cavalier &  
Pontiac Sunfire  
1995 - On

UNIT PACKAGE: 50



**20344**  
(10169777)  
Black Nylon

Weatherstrip Retainer  
**Replaces Auveco 18322**  
Chevrolet Impala, Lumina  
& Monte Carlo And  
Pontiac Aztek  
1995 - On

UNIT PACKAGE: 25



**18389**  
(25603960)  
Black Nylon

Radiator Baffle Retainer  
Olds 98 Regency  
1994-On

UNIT PACKAGE: 25



**14021**  
(N803170-S)  
Black Nylon

Facia Retainer  
Ford Mustang  
& Capri 1984-On

UNIT PACKAGE: 25



**11120**  
(8731909)  
Black Nylon

Door Weatherstrip Retainer  
GM 1963-On

UNIT PACKAGE: 100



**18302**  
(20538173)  
Black Nylon

Weatherstrip Retainer  
Buick Century & Riviera,  
Chevrolet Lumina, Olds  
Aurora & Regency and  
Pontiac Grand Prix  
1989-On

UNIT PACKAGE: 50



**14006**  
(20455900)  
Black Nylon

Moulding Retainer  
GM 1984-On

UNIT PACKAGE: 25



**18158**  
(GM: 10154466;  
Chrys 34202839)  
Black Nylon

Door Jam Plug Retainer  
Cadillac, Chevrolet  
& Pontiac 1987-On  
Dodge Monaco

UNIT PACKAGE: 50



**18298**  
(22536642)  
Black Nylon

Rear Bumper  
Fascia Retainer  
Chevy Cavalier, Olds  
Calais, Pontiac Grand Prix,  
Sunbird & 6000  
1988-On

UNIT PACKAGE: 50



**11129**  
(2964547)  
Black Nylon

Weatherstrip Retainer  
Chrysler 1977-On

UNIT PACKAGE: 25



**20311**  
(N803857S)  
Black Nylon

Front End Fascia Retainer  
**Replaces Auveco 15483**  
Ford Aerostar, LTD &  
Marquis  
1985 - On

UNIT PACKAGE: 50



**11721**  
(411700)  
Black Nylon

Trim Panel Retainer  
GM 1968-On

UNIT PACKAGE: 50



**19149**  
(4658673)  
Black Nylon

Weatherstrip Retainer  
Front & Rear Doors  
Chrysler Neon  
1996-On

UNIT PACKAGE: 50



**18948**  
(1644290)  
Black Nylon

Rear Bumper Fascia  
& Door Trim Plate Retainer  
GM 1991-On

UNIT PACKAGE: 25



**11680**  
(25016383)  
Black Nylon

Dash Panel Retainer  
GM 1977-On

UNIT PACKAGE: 50



**19836**  
(6505417AA)  
Black Nylon

Trim Panel Retainer  
Chrysler

UNIT PACKAGE: 50



**20456**  
(6502078)  
Natural Nylon

Trim Panel Retainer  
Jeep Cherokee  
1987 - On

UNIT PACKAGE: 25

# TRIMMING SUNDRIES & FASTENERS

**Sec. 19**

Refer to Retainer Specification Chart on pages 381 - 387.



**12993**  
(7703-077-066)  
Black Nylon

Rear Window Moulding  
AMC Renault & Alliance  
1983-On

UNIT PACKAGE: 25

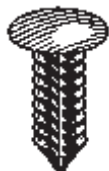

**18682**  
(10098645)  
Black Nylon

Front Door Lower  
Moulding Retainer  
Pontiac Grand Prix  
With Sport Performance  
Package  
1994-On

UNIT PACKAGE: 50



**18686**  
(24574578)  
Black Nylon

Air Cleaner To  
Battery Tray Retainer  
Chevrolet Cavalier And  
Pontiac Sunfire  
1995-On

UNIT PACKAGE: 50



**14017**  
(390126-S)  
Black Nylon

Fascia Retainer  
Ford Mustang & Capri  
1984-On

UNIT PACKAGE: 25

**14857**

Same as 14017  
except for packing

UNIT PACKAGE: 50



**14921**  
(GM: 20699808;  
Chry: 6502328)  
Black Nylon

Door Weatherstrip Retainer  
GM 1974-On  
Dodge Ram 1994-On

UNIT PACKAGE: 50



**11612**  
(GM: 20413107;  
Ford: 388246S  
AMC: 4006516)  
Black Nylon

Weatherstrip Fastener  
GM, Ford & AMC

UNIT PACKAGE: 50



**18815**  
(6502381)  
Black Nylon

Radiator Grille  
Sight Shield Retainer  
Dodge Caravan  
& Plymouth Voyager  
1993-On

UNIT PACKAGE: 50



**15050**  
Black Nylon

Shroud Retainer  
High Retention Capability  
GM, Ford & Chrysler

UNIT PACKAGE: 50



**15367**  
(20514862)  
Black Nylon

Screen Shroud Vent  
Grille to Panel Retainer  
GM 1985-On

UNIT PACKAGE: 50



**11675**  
(GM: 25514221;  
Chry: 6003587)  
Natural Nylon

Roof Headliner Retainer  
GM & Chrysler  
1982-On

UNIT PACKAGE: 50



**14709**  
(Mazda: G030-68-885-B-38;  
Ford: F22Z-16774-A,  
GA2A-56694)  
Nylon

Hood Insulation Retainer  
Mazda & Ford Probe

UNIT PACKAGE: 25



**20332**

(GM: 10182300;  
Chry: 6033018;  
Ford: N803678-S)  
Black Nylon

Bumper, Fender, Trim  
Panel, Seat & Carpet  
Retainer

**Replaces Auveco 18307**  
GM, Ford & Chrysler  
1991-On

UNIT PACKAGE: 50



**20399**  
(W701374-S)  
Black Nylon

Hood Insulation Retainer  
Ford Escape  
2001-On

UNIT PACKAGE: 25



**11679**  
(GM: 20032850;  
Ford: 387258-S;  
Chry: 3861577)  
Black Nylon

Mud Shield Retainer  
GM, Ford & Chrysler  
1976-On

UNIT PACKAGE: 100



**13454**  
(20511451)  
Black Nylon

Cowl Vent Retainer  
GM 1984-On

UNIT PACKAGE: 25



**11347**  
(3861577)  
Black Nylon

Front Seat Adjuster Cover  
Retainer  
Chrysler 1975-On

UNIT PACKAGE: 25



**17453**  
(B003-68-865-96)  
Gray Nylon

Rear Compartment  
Interior Trim Retainer  
Ford Probe 1988-On  
Mazda MX6 1988-On

UNIT PACKAGE: 50



**18820**  
(N807951S)  
Black Nylon

Access Hole  
Cover Retainer  
Ford Mustang  
1994-On

UNIT PACKAGE: 100



**19667**  
(N801994-S100)  
Black Nylon

Trim Panel Retainer  
Ford  
1982 - On

UNIT PACKAGE: 25

**Sec. 19**

**TRIMMING SUNDRIES & FASTENERS**

Refer to Retainer Specification Chart on pages 381 - 387.



**14028**  
(15594416)  
White Nylon

Bumper End Cap Retainer  
GM Astro & Safari  
Mini-Vans 1985-On  
UNIT PACKAGE: 25



**19893**  
(6501948)  
Black Nylon

Fender & Bumper  
Shield Retainer  
Chrysler  
1995 - 89

UNIT PACKAGE: 50



**20361**  
(6506005AA)  
Black Nylon

Fender Liner Retainer  
Jeep Grand Cherokee  
1999 - On

UNIT PACKAGE: 50



**20624**  
(Ford:  
W709002-SAA)  
Black Nylon

Fender Flare Retainer  
Ford Expedition &  
Navigator  
2003 - On

UNIT PACKAGE: 25



**18897**  
(10078274)  
Black Nylon

Side Roof Rail  
Weatherstrip Retainer  
Chevrolet Corsica & Beretta  
1989-87

UNIT PACKAGE; 25



**18379**  
(W701380SSW)  
Black Nylon

Retainer  
Trunk Liner, Rear Seat  
Carpet, & Radiator  
Side Shield  
Ford Contour & Mercury  
Mystique 1995-On

UNIT PACKAGE: 25



**19471**  
(W700770-S300)  
Black Nylon

Front & Rear Door  
Trim Panel Retainer  
Lincoln Town Car  
1990-On

UNIT PACKAGE: 25

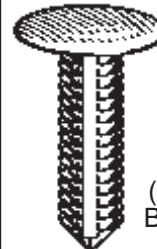

**18301**  
(10185925)  
Black Nylon

Bumper Fascia Retainer  
Chevy Lumina APV,  
Olds Silhouette  
& Pontiac Trans Sport  
1993-On

UNIT PACKAGE: 25



**14757**  
(N804448)  
Black Nylon

Engine Mount  
Heat Shield Retainer  
Ford Taurus & Sable  
1986-On

UNIT PACKAGE: 25



**18174**  
(25601491)  
Black Nylon

Radiator Air Side  
Baffle & Door Trim  
Panel Retainer  
Buick LeSabre &  
Olds Delta 88 Royale  
1992-On

UNIT PACKAGE: 50



**16818**  
(GM: 21094146;  
Chrys: 6501301)  
Black Nylon

Trim Panel Retainer  
GM Saturn 1991-On  
Sliding Door & Lift Gate  
Trim Panel Retainer  
Chrys. Mini Vans 1987-On

UNIT PACKAGE: 25

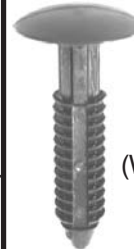

**20177**  
(W705955-S300)  
Charcoal Gray  
Nylon

Wheel Opening  
Moulding Retainer  
Ford Explorer  
1998 - On

UNIT PACKAGE: 50



**20178**  
(10185866)  
Black Nylon

Headlight Trim &  
Liftgate Moulding Retainer  
Oldsmobile Silhouette,  
Pontiac Trans Sport And  
GM C & K Trucks  
1992 - On

UNIT PACKAGE: 25



**20531**  
(W708035-S300)  
Black Nylon

Rear Bumper Cover  
Retainer  
**Use With Auveco 20532**  
Ford Expedition  
2003 - On

UNIT PACKAGE: 25



**15040**  
(Chrys: 5208743;  
AMC: 4006529)  
Black Nylon

Trim Panel Retainer  
Chrysler 1988-84  
AMC 1988-84

UNIT PACKAGE: 50



**19774**  
Black Nylon

Bumper Cover  
Retainer  
Postal Vehicles  
& General Purpose  
**Replaces Auveco  
18106**

UNIT PACKAGE: 25



**18859**  
(10119816)  
Black Nylon

Panel Retainer  
Air Intake Grille  
Panel Retainer  
Chevrolet Camaro  
1991-On

UNIT PACKAGE: 25

# TRIMMING SUNDRIES & FASTENERS

## Sec. 19

Refer to Retainer Specification Chart on pages 381 - 387.



**20366**  
(W701855-S300)  
Black Nylon

Fender Liner &  
Mud Flap Retainer  
Ford Explorer &  
Mountaineer  
2002 - On

UNIT PACKAGE: 25

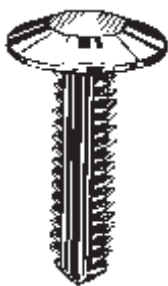

**18371**  
(15986343)  
Gray Nylon

Door Trim  
Panel Retainer  
Chev. Astro  
& GMC Safari  
Mini Vans  
1994-On

UNIT PACKAGE: 25



**14035**  
(22527720)  
Natural Nylon

Hood Seal  
Retainer  
GM 1981-On

UNIT PACKAGE: 25



**19855**  
(4717224)  
Black Nylon

Trim Panel Retainer  
Chrysler Concorde,  
Intrepid,  
LHS, New Yorker, Vans &  
Vision  
1993 - On

UNIT PACKAGE: 50



**14032**  
(15588078)  
Black Nylon

Pillar Cover  
Retainer  
GM Truck  
1985-On

UNIT PACKAGE: 10



**10831**  
(GM: 332364;  
Ford: 389358;  
Chry: 3691590,  
6031321;  
AMC: 4004569)  
Black Nylon

Fender & Bumper  
Shield Retainer  
GM, Ford, Chrysler & AMC

UNIT PACKAGE: 50



**20192**  
Not Available From O.E.M.  
Black Nylon

Mud Flap Retainer  
Ford Expedition & F-150  
1997 - On

UNIT PACKAGE: 25



Roof Trim &  
Garnish Retainer  
Ford Explorer 1992-On

**19352**  
(N807155-S)  
Medium Mist Gray  
UNIT PACKAGE: 25

**19354**  
(N807155-S)  
Medium Camel Tan  
UNIT PACKAGE: 25



**14036**  
(14074081)  
Black Nylon

Rear Hood  
Seal Retainer  
GM 1983-On

UNIT PACKAGE: 25



**10832**  
(480534, 6270163)  
Gray Nylon

Fender & Bumper Shield  
Retainer  
GM 1973-On

UNIT PACKAGE: 50

**Sec. 19****TRIMMING SUNDRIES & FASTENERS**

Refer to Retainer Specification Chart on pages 381 - 387.

**15664**  
White NylonFender & Bumper Shield Retainer  
GM, Ford, Chrysler & AMC

UNIT PACKAGE: 100

**11146**  
(GM: 1595864, 1605396;  
Chry: 6030441;  
Ford: 388577S,  
W705589-S300)  
Black NylonRadiator Yoke, Fender &  
Bumper Shield Retainer  
GM, Ford & Chrysler

UNIT PACKAGE: 25

**15414**Same as 11146  
except for packing

UNIT PACKAGE: 100

**19790**Not Available From O.E.M.  
Gray Nylon

Trim Panel Retainer

**Gray version of  
Auveco 11146**  
GM, Ford & Chrysler

UNIT PACKAGE: 50

**19250**Not Supplied  
By O.E.M.  
White NylonTrim Panel Retainer  
**White Version Of  
Auveco 11146**

UNIT PACKAGE: 25

**17664**(GM: 10121502;  
Chry: 6033082, 6033840;  
Ford: 390018-S)  
Black NylonShield Retainer  
Battery Post Cable Shield,  
Engine Splash Shield  
Radiator Side Air Baffle  
GM 1989-On

UNIT PACKAGE: 50

**17612**(Chry: 6504043;  
Ford: N807721-S)  
Black NylonTrim Panel Retainer  
Ford Explorer  
1993-On  
Trunk Lid Latch  
Chrysler 1996-On

UNIT PACKAGE: 50

Trim Panel  
RetainerFord Explorer, Mountaineer,  
Windstar & Ranger  
1991-On**19371**(N807154-S)  
Dark Denim (Blue) Nylon

UNIT PACKAGE: 50

**19372**(N807154-S)  
Dark Graphite (Gray) Nylon

UNIT PACKAGE: 50

**19373**(N807154-S)  
Zuca Granite  
(Light Gray) Nylon

UNIT PACKAGE: 50

**19374**(N807154-S)  
Medium Prairie Tan Nylon

UNIT PACKAGE: 50

**15543**(GM: 22547243,  
Chry: 6501916)  
Black NylonSplash Shield & Wheel Well  
Cover Retainer  
Chrysler 1988-On  
Hood Seal Retainer  
GM 1989-On

UNIT PACKAGE: 50

**17076**(GM: 94145515;  
Isuzu:  
8941455150)  
Black NylonInner Fender Shield &  
Bumper Fascia Retainer  
Geo Storm & Isuzu  
1990-On

UNIT PACKAGE: 25

**19834**(15975244)  
Black NylonWiring Harness &  
Headliner Retainer  
Engine Wiring Harness,  
Tailgate, Headliner &  
Air Cleaner  
GM C, E, K, S & T Trucks  
1994 - On

UNIT PACKAGE: 50

**19837**Not Available From O.E.M.  
Black NylonTrim Panel Retainer  
Chrysler

UNIT PACKAGE: 50

# TRIMMING SUNDRIES & FASTENERS

**Sec. 19**

Refer to Retainer Specification Chart on pages 381 - 387.



**19127**  
(N808370-S)  
Black Nylon

Carpet Retainer  
Ford Taurus & Sable  
1996-On

UNIT PACKAGE: 25



**18685**  
(3548804)  
Black Nylon

License Plate Bracket &  
Bumper Fascia Retainer  
Cadillac Eldorado & Seville  
1995-On

UNIT PACKAGE: 25



**20189**  
(GM: 16674629;  
Ford: N806113-S;  
Chry: 6503943)  
Black Nylon

Trim Panel Retainer  
Cadillac Concours,  
DeVille & Seville;  
Chevrolet Impala,  
Lumina & Monte Carlo;  
Dodge Ram & Dakota;  
Ford and  
Pontiac Grand Prix  
1995 - On

UNIT PACKAGE: 50



**20360**  
(22189414)  
Black Nylon

Engine Compartment &  
Front End Retainer  
Buick LeSabre, Park Ave.,  
Rendezvous, & Riviera;  
Cadillac DeVille & Seville;  
Chevrolet Venture,  
Oldsmobile Silhouette  
And Pontiac Aztek,  
Bonneville & Montana  
2000 - On

UNIT PACKAGE: 25



Kick Plate Retainer  
Ford Ranger  
1993 - On

**19760**  
(N807535-S)  
Black Nylon

UNIT PACKAGE: 50

**19761**  
(N807535-S)  
Prairie Tan Nylon

UNIT PACKAGE: 50

**19762**  
(N807535-S)  
Graphite Nylon

UNIT PACKAGE: 50

**19763**  
(N807535-S)  
Dark Graphite Nylon

UNIT PACKAGE: 50



**15523**  
(E9SB-6302354-ACW)  
Black Nylon

Cowl Side Trim Retainer  
Ford T-Bird & Cougar  
1989-On

UNIT PACKAGE: 25



**19540**  
(6504980AA)  
Black Nylon

Cowl Grille Retainer  
Dodge Durango  
1998 - On

UNIT PACKAGE: 25



**20319**  
(W700671-S300)  
Black Nylon

Hood Insulation Retainer  
Ford Contour & Mystique  
1995 - On

UNIT PACKAGE: 25



**19541**  
(6504135)  
Black Nylon

Hood Insulation Retainer  
Chrysler Mini-Vans &  
Durango  
1997 - On

UNIT PACKAGE: 50



**10332**  
(2998430)  
Black Nylon

Radiator Grille Retainer  
Chrysler

UNIT PACKAGE: 25



**15481**  
(6501067)  
Black Nylon

Fascia Retainer  
Chrysler 1985-On

UNIT PACKAGE: 50



**15480**  
(N802734S)  
Black Nylon

Trim Panel Retainer  
Ford 1983-On

UNIT PACKAGE: 50

**19197**  
(N802734-S)  
Medium Opal (Gray) Nylon

UNIT PACKAGE: 50

**Sec. 19****TRIMMING SUNDRIES & FASTENERS**

Refer to Retainer Specification Chart on pages 381 - 387.

**12731**(20319841)  
Black NylonSeat Back  
Retainer  
GM Camaro  
& Firebird  
1982-On

UNIT PACKAGE: 25

**11351**(Ford: 385661-S;  
Chry: 6003349, 6032363;  
VW: N989022)  
Black NylonDoor Trim Panel Retainer  
Ford, Chrysler & VW  
1975-On

UNIT PACKAGE: 25

**20262**(22642756)  
Black NylonTrunk Trim Retainer  
Chevrolet Cavalier &  
Pontiac Sunfire  
1995 - On

UNIT PACKAGE: 25

**12137**(1619321)  
Black NylonRadiator Apron  
Panel Retainer  
GM 1977-On

UNIT PACKAGE: 25

**12571**(389443-S)  
Black NylonFascia To Bumper Retainer  
Ford 1981-On

UNIT PACKAGE: 25

**20362**(15056810)  
Black NylonBumper Fascia Retainer  
GM S & T Trucks  
2002 - On

UNIT PACKAGE: 25

**16263**Same as 12137  
except for packing  
UNIT PACKAGE: 50**20281**(11518201)  
Black NylonBumper Fascia Retainer  
Pontiac Grand Am  
1999 - On

UNIT PACKAGE: 15

**18826**(4696963)  
Black NylonHeadliner Retainer  
Chrysler Cirrus,  
Stratus, and Van 1995-On

UNIT PACKAGE: 25

**12766**(22512276)  
Black NylonFront End Stone Shield  
Retainer  
GM 1981-On

UNIT PACKAGE: 25

**18679**(20652520)  
Gray NylonCompensator Panel To  
Quarter Panel Retainer  
Buick Century & Skylark,  
Cadillac Fleetwood And  
Olds Calais 1992-83

UNIT PACKAGE: 25

**11673**(GM: 2048248;  
Chry: 6003423)  
Natural NylonInterior Trim  
Panel Retainer  
GM & Chrysler 1977-On

UNIT PACKAGE: 50

**20316**(Ford: 388904-S;  
Chry: 4381395,  
6501086)  
Black NylonDoor Frame Spacer  
Retainer  
Chrysler 1985-On  
Bumper Retainer  
Ford 1981-On  
**Replaces Auveco 14042**

UNIT PACKAGE: 50

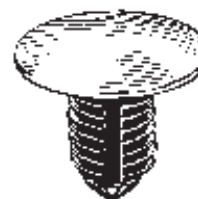
**15478**(GM: 1631564;  
Ford: N804379S)  
Black NylonBumper Fascia Retainer  
Buick, Cadillac & Olds  
1981-On  
Taurus & Sable 1986-On

UNIT PACKAGE: 50



# TRIMMING SUNDRIES & FASTENERS

# Sec. 19

Refer to Retainer Specification Chart on pages 381 - 387.



**18771**

(6502104)

Black Nylon

Headlight Mounting Panel  
To Crossmember Sight  
Shield Retainer  
Dodge Daytona 1993

UNIT PACKAGE: 25



**18680**

(10229437, 10242316)

Black Nylon

Headlining Trim Finish  
Panel Retainer  
Buick Skylark, Chevrolet  
Camaro, Cavalier, Lumina  
& Monte Carlo, Oldsmobile  
Cutlass And Pontiac  
Firebird, Grand Am,  
Grand Prix & Sunfire  
1992-On

UNIT PACKAGE: 25

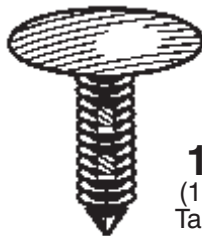

**19501**

(10249241)

Tan Nylon

Headliner Trim  
Panel Retainer  
Buick Century, Regal &  
Skylark;  
Chev. Camaro, Cavalier,  
Lumina, Monte Carlo &  
Venture; Oldsmobile  
Silhouette and Pontiac  
Firebird, Grand Am, Sunfire  
& Trans Sport  
1995 - On

UNIT PACKAGE: 25

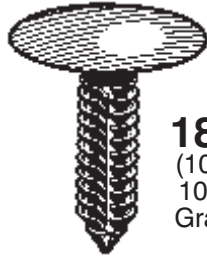

**18688**

(10220168,

10241518)

Gray Nylon

Headlining Trim Finish  
Panel Retainer  
Buick Century & Regal,  
Chevrolet Caprice, Camaro,  
Lumina & Monte Carlo,  
Olds Cutlass Ciera And  
Pontiac Firebird &  
Grand Prix  
1992-On

UNIT PACKAGE: 50



**20345**

(15006827)

Gray Nylon

Headliner Retainer  
GM C & K Trucks  
2000 - On

UNIT PACKAGE: 25



**20625**

(Ford: XW7Z-6302354-AAB)

Tan Nylon

Headliner Retainer  
Ford Expedition &  
Navigator  
2003 - On

UNIT PACKAGE: 25



**12759**

(14027471)

Black Nylon

Trim Panel  
Retainer  
GM Trucks  
1981-On

UNIT PACKAGE: 25



**12909**

(388930-S)

Black Nylon

Trim Panel Retainer  
Ford 1980-On

UNIT PACKAGE: 50



**19385**

(MB020923)

Gray Nylon

Hood Insulation Retainer  
Jeep Eagle &  
Mitsubishi Eclipse  
1992-On

UNIT PACKAGE: 10



**15479**

(N804349S)

Black Nylon

Interior Trim  
Retainer  
Ford 1986-On

UNIT PACKAGE: 25

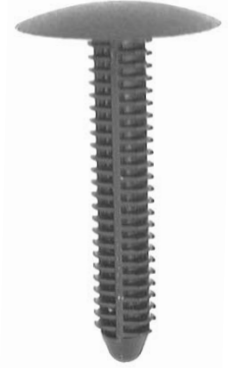

Trim & Garnish Retainer  
Ford Vans  
1992 -On

**19845**

(E8FZ-5802354A)

Medium Graphite Nylon

UNIT PACKAGE: 25

**19846**

(F2UZ-1602354AAA)

Black Nylon

UNIT PACKAGE: 25



Roof Trim Panel & Garnish  
Moulding Retainers  
Ford Ranger  
1992-On

**18275**

(N806344-S)

Blue Nylon

UNIT PACKAGE: 25

**18277**

(N806344-S)

Gray

UNIT PACKAGE: 25

**Sec. 19**

**TRIMMING SUNDRIES & FASTENERS**

Refer to Retainer Specification Chart on pages 381 - 387.



**11842**

(N-800387-S)  
Black Nylon

Dashboard Retainer  
Ford 1979-On

UNIT PACKAGE: 25



**11350**

(4005250)  
White Nylon

Door Panel Retainer  
American Motors 1976-On

UNIT PACKAGE: 25

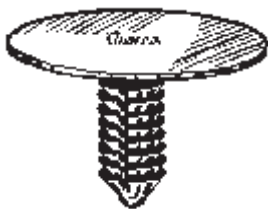

**17381**

(N805315)  
Gray Nylon

Headliner Retainer  
Ford Aerostar 1986-On

UNIT PACKAGE: 10

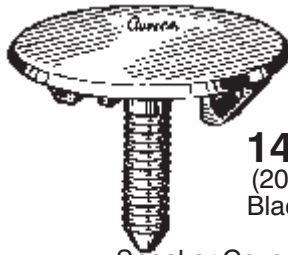

**14219**

(20432601)  
Black Nylon

Speaker Cover To  
Bracket Retainer  
GM 1985-On

UNIT PACKAGE: 25



**19338**

(Chry: 6504098;  
Ford: N808842-S)  
Black Nylon

Hood Insulation Retainer  
Chrysler Sebring 1996-On  
Ford Taurus, Sable  
& Mark VIII  
1996-On

UNIT PACKAGE: 50

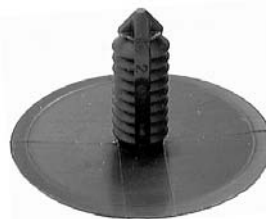

**20615**

(11517992)  
Black Nylon

Fender Liner Retainer  
Pontiac Bonneville  
2000 - On

UNIT PACKAGE: 25



**20541**

(TY98TL2-AA)  
Tan Nylon

Headliner Retainer  
Chrysler Caravan, Town & Country  
And Voyager Mini-Vans  
2001 - On

UNIT PACKAGE: 25



Headliner Retainer  
Chrysler Caravan, Voyager  
and Town & Country  
1997-On

**19382**

(QL77SC1)

Light Mist Gray Nylon

UNIT PACKAGE: 25

**19383**

(QL77SK4)

Light Camel Tan Nylon

UNIT PACKAGE: 25

**19384**

(QL77SJJ)

Light Silver Fern Nylon

UNIT PACKAGE: 25

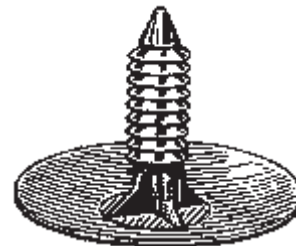

**15457**

(20030401)

Black

Polypropylene

Hood Insulation Retainer  
GM 1980-On

UNIT PACKAGE: 25



**15456**

(20064875)

Black Nylon

Hood Insulation Retainer  
GM 1980-On

UNIT PACKAGE: 25

# TRIMMING SUNDRIES & FASTENERS

**Sec. 19**

Refer to Retainer Specification Chart on pages 381 - 387.



**11130**  
(3078511,  
3977775)  
Black Nylon

Hood Insulation Retainer  
GM 1964-On

UNIT PACKAGE: 25

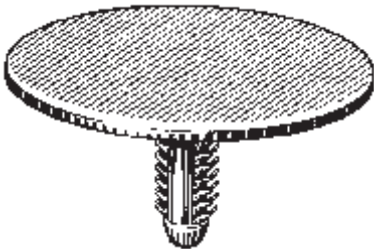

**16863**  
(N803613S)  
Black Nylon

Hood Insulation Retainer  
Ford Bronco, Explorer & Ranger  
1988-On

UNIT PACKAGE: 25

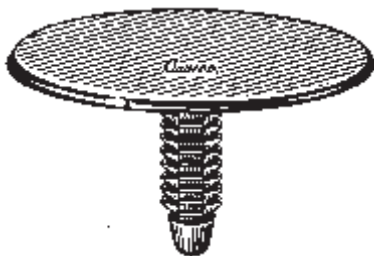

**15668**  
(N803387)  
Black Nylon

Trim Panel Retainer  
Ford

UNIT PACKAGE: 25

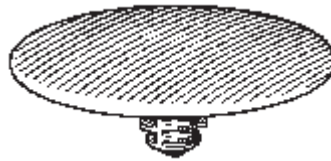

**17215**  
(21039141)  
Black Nylon

Hood Insulation Retainer  
GM Saturn 1991-On

UNIT PACKAGE: 25



**19655**  
(386553-S)  
Black Nylon

Hood Insulation  
Retainer  
Ford 1975-On

Replaces Auveco 13571

UNIT PACKAGE: 25



**14163**  
(388908-S)  
Black Nylon

Hood Insulation  
Retainer  
Ford 1975-On

UNIT PACKAGE: 50



**17975**  
(Chry: 6502842,  
GM: 21039129)  
Black Nylon

Hood Insulation Retainer  
Chrysler Concorde, Dodge Intrepid  
& Eagle Vision  
1993 - On

GM Corvette, Equinox & Saturn  
1992 - On

UNIT PACKAGE: 50



**20164**  
(4878883AA)  
Black Nylon

Hood Insulation Retainer  
Chrysler LH & LHS Series  
1997 - On

UNIT PACKAGE: 50



**17004**  
(4341060)  
Black Nylon

Hood Insulation & Fender  
Shield Retainer  
Chrysler 1985-On

UNIT PACKAGE: 25

**Do You Want Your  
Customers To Know  
You Use The Best  
Body Hardware &  
Specialty Fasteners  
Available?**

**Promotional Products And  
Apparel Bearing**

The  Logo  
**Promote Your Identity  
As A Professional.**

**Sec. 19**

**TRIMMING SUNDRIES & FASTENERS**

Refer to Retainer Specification Chart on pages 381 - 387.



**19155**  
(4428987)  
Black Nylon

Hood Insulation Retainer  
Dodge Ram  
1994-On

UNIT PACKAGE: 25



Headliner Retainer  
Chrysler Vans

**18087**  
(JB66 PD5)  
Gray Nylon

UNIT PACKAGE: 50

**18089**  
(J66 PB7)  
Blue Nylon

UNIT PACKAGE: 50



**17237**  
Black Nylon

Hood Insulation Retainer  
Mercury Villager  
1999-On

UNIT PACKAGE: 15

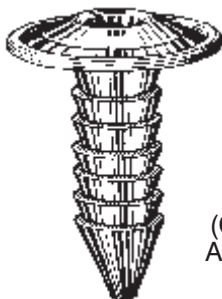

**13467**  
(GM: 7642589;  
AMC: 4001934)  
Black Nylon

Firewall Insulation  
Retainer  
GM & AMC

UNIT PACKAGE: 25



**19532**  
(W702010-S300)  
Black Nylon

Door Weatherstrip Retainer  
Ford Contour & Mystique  
1995 - On

UNIT PACKAGE: 25



**17072**  
(15659161)  
Black Nylon

Front Door Frame Hole Plug  
GM Blazer, Jimmy & Pickup  
1989-On

UNIT PACKAGE: 25



**17339**  
(N806289-S)  
Black Nylon

Weatherstrip Retainer  
Lincoln 1989-On

UNIT PACKAGE: 50



**19368**  
(10283414, 10405030)  
Natural Nylon

Door Weatherstrip Retainer  
Buick Century & Regal and  
Oldsmobile Intrigue  
1997-On

UNIT PACKAGE: 100



**20181**

Not Available From O.E.M.  
White Nylon

Weatherstrip Retainer  
Chrysler LH & LHS Series  
1997 - On

UNIT PACKAGE: 100



**14985**  
(2664040)  
White Nylon

Door Weatherstrip Retainer  
Chrysler  
1966 - On

UNIT PACKAGE: 100

# TRIMMING SUNDRIES & FASTENERS

**Sec. 19**

Refer to Retainer Specification Chart on pages 381 - 387.



**19850**  
(N806340-S)  
Natural Nylon

Weatherstrip Retainer  
Ford F150  
1999 - On

UNIT PACKAGE: 100



**10744**  
(4876498)  
Black Nylon

Weatherstrip Retainer  
GM  
UNIT PACKAGE: 100



**19678**  
Not Available From O.E.M.  
White Nylon

Weatherstrip Retainer  
Ford Windstar  
1995 - On

UNIT PACKAGE: 50



**18033**  
(Chrys: 4696129;  
GM: 21077575)  
White Nylon

Weatherstrip Retainer  
Chrysler Concorde & LHS  
Dodge Intrepid & Eagle Vision  
1993-On

Oldsmobile Alero &  
Pontiac Grand Am  
1999 - On

UNIT PACKAGE: 50



**20180**  
Not Available From O.E.M.  
Black Nylon

Weatherstrip Retainer  
Chrysler LH & LHS Series  
1997 - On

UNIT PACKAGE: 100



**19425**  
(385677)  
Natural Nylon

Weatherstrip Retainer  
Ford

UNIT PACKAGE: 50



**18330**  
(94848189,  
94848192)  
White Nylon

Front Door Weatherstrip Retainer  
Geo Prizm  
1992-89

UNIT PACKAGE: 25



**18510**  
(20200750)  
Natural Nylon

Hood Seal Retainer  
Buick, Cadillac, Chevrolet,  
GMC & Oldsmobile  
1970-On

UNIT PACKAGE: 100



**8853**  
(C5AB-6220586A)  
Natural Nylon

Door Weatherstrip Retainer  
Ford

UNIT PACKAGE: 50



**20183**  
Not Available From O.E.M.  
Black Nylon

Weatherstrip Retainer  
Chrysler LH & LHS Series  
1997 - On

UNIT PACKAGE: 100



**19449**  
(10403591)  
Black Nylon

Rear Bumper Fascia Retainer  
Oldsmobile Intrigue &  
Pontiac Grand Prix  
1998-On

UNIT PACKAGE: 25



**18508**  
(4001916)  
Black Nylon

Weatherstrip Retainer  
Jeep Wrangler  
1991-On

UNIT PACKAGE: 50



**18509**  
(4040732)  
Natural Nylon

Weatherstrip Retainer  
Hood Inner Panel To Cowl &  
Door Weatherstrip  
Dodge F.W.D. Pick-Up  
1989-82

UNIT PACKAGE: 100



**19418**  
(GM: 480534;  
Ford: 384051-S)  
Black Nylon

Cowl Insulation Retainer  
GM  
Splash Shield and Wire Retainer  
Ford

UNIT PACKAGE: 25



**20182**  
Not Available From O.E.M.  
White Nylon

Weatherstrip Retainer  
Chrysler LH & LHS Series  
1997 - On

UNIT PACKAGE: 100

**Sec. 19****TRIMMING SUNDRIES & FASTENERS**

Refer to Retainer Specification Chart on pages 381 - 387.

**11136**(Ford: 385330-S,  
D30Z-16776-A;  
Chry: 6003351)  
Black NylonHood Insulation Retainer  
Chrysler 1972-On  
Grille to Radiator Retainer  
Ford 1973-On

UNIT PACKAGE: 25

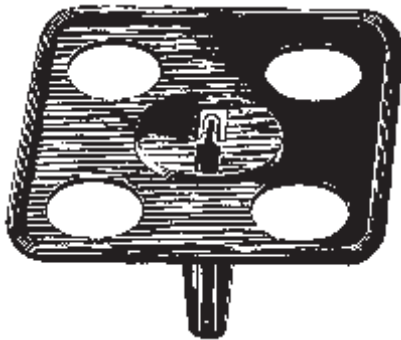
**13757**(389809)  
Black NylonHood Insulation Retainer  
2" Square  
GM 1980-On

UNIT PACKAGE: 25

**18248**(55055098)  
Black NylonHeadlight Grille Retaining Clip  
Dodge Ram 1994-On

UNIT PACKAGE: 25

**18297**(Toyota: 90467-08004,  
90467-08011;  
GM: 94842841, 94849113)  
Black NylonHood Seal Retaining Clip  
Lexus, Toyota, Geo Prizm & Nova  
1985 - On

UNIT PACKAGE: 50

**18458**(Ford: F1CZ-16774-A;  
Mazda: B455-56-741)  
Black NylonHood Insulation Retaining Clip  
Ford Probe 1992-88  
Mazda MX6 1992-88

UNIT PACKAGE: 25

**18827**(6503892)  
Black NylonHood Insulation Retainer  
Chrysler Cirrus & Stratus  
1995-On

UNIT PACKAGE: 50

**3620**(4801268)  
Black NylonDoor Flange  
Weatherstrip Retainer  
GM

UNIT PACKAGE: 100

**3639**(C1AB-6220807-A)  
White NylonDoor Flange  
Weatherstrip Retainer  
Ford

UNIT PACKAGE: 100

**5592**(375372-S)  
Black NylonRadiator Top  
Shield Retainer  
Ford

UNIT PACKAGE: 100

**20576**(GM: 88969790;  
Toyota: 75867-21010)  
Yellow NylonFender Flare Retainer  
Pontiac Vibe &  
Toyota Echo  
2002 - On

UNIT PACKAGE: 25

**19802**(MB566719)  
White NylonDoor Moulding Retainer  
Chrysler Concorde,  
Eagle Talon & Sebring  
1996 - On

UNIT PACKAGE: 15

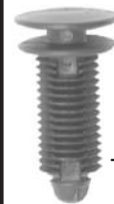
**19810**(N807943-S)  
Black NylonTrim Panel Retainer  
Ford Mustang  
1995 - On

UNIT PACKAGE: 50

**20634**(GM: 10363811;  
22722859)  
White NylonDoor Panel Retainer  
**Use With Auveco 20635**Oldsmobile Alero &  
Pontiac Grand Am  
2002 - On

UNIT PACKAGE: 25

**20274**Not Supplied  
By O.E.M.  
White NylonDoor Panel Retainer  
**Use With Auveco 20275**Chrysler LH Series  
2000 - On

UNIT PACKAGE: 25

**12565**(N801925-S)  
Black NylonDoor Trim  
Panel Retainer  
Ford 1981-On

UNIT PACKAGE: 25

# TRIMMING SUNDRIES & FASTENERS

# Sec. 19

Refer to Retainer Specification Chart on pages 381 - 387.



**13470**  
(N802900)  
White Nylon

Door Trim Panel Retainer  
Ford

UNIT PACKAGE: 25



**11671**  
(387182-S)  
White Nylon

Seat Back  
Panel Retainer  
Ford 1977-On

UNIT PACKAGE: 25



**18848**  
(F58Z-16237A02-A)  
Yellow Nylon

Door Trim Panel Retainer  
Ford Windstar  
1995-On

UNIT PACKAGE: 25

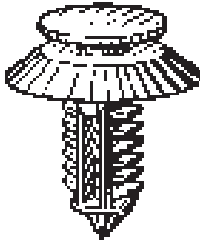

**17218**  
(21042045,  
21042053,  
21042058,  
21042104)  
Natural Nylon

Door Trim Panel Retainer  
GM Saturn  
1991-On

UNIT PACKAGE: 50



**17102**  
(GM: 10143422;  
Ford: N805612-S100;  
AMC: 8934-202-599)  
White Nylon

Trim Panel Retainer  
Ford Tempo & Topaz, Jeep Eagle &  
Premier and Pontiac 1988-On

UNIT PACKAGE: 50



**20467**  
(6506853-AA)  
Black Nylon

Trim Panel Retainer  
With Sealer  
**Use With Auveco 20468**  
Chrysler Sebring & Stratus  
2001 - On

UNIT PACKAGE: 15



**17124**  
(N805155-S)  
Black Nylon

Trim Panel Retainer  
Ford 1985-On

UNIT PACKAGE: 50



**18391**  
(15694099)  
Natural Nylon

Rear Door  
Trim Panel Retainer  
Chev. Astro &  
GMC Safari Mini Vans  
1993-On

UNIT PACKAGE: 15



**17985**  
(94340505; 97018938)  
White Nylon

Rocker Panel Retainer  
Geo Storm GSI  
1990 - On

UNIT PACKAGE: 10



**18175**  
(10158124)  
Natural Nylon

Trim Panel Retainer  
GM, Chrysler  
1992-On

UNIT PACKAGE: 50



**18824**  
(G350-68-AB1)

Trim Panel Retainer  
Mazda 626, MX-6,  
Millenia, MX-3, 929,  
Protege, MPV  
Ford Probe  
1990 - On

UNIT PACKAGE: 50



**19213**  
(6503709)  
Natural Nylon

Trim Panel Retainer  
Dodge Ram  
1994-On

UNIT PACKAGE: 50



**20559**  
(GM: 88970345;  
Toyota: 90467-10167)  
Blue Nylon

Garnish Moulding  
Retainer  
Pontiac Vibe, Lexus  
and Toyota  
2000 - On

UNIT PACKAGE: 25

**Sec. 19****TRIMMING SUNDRIES & FASTENERS**

Refer to Retainer Specification Chart on pages 381 - 387.



**18876**  
(Toyota: 90467-10161;  
GM: 94858299)  
White Nylon

Trim Board Retainer  
Sienna, Solara & Tercel  
1990 - On  
Geo Prizm & Pontiac Vibe  
1998 - On

UNIT PACKAGE: 25



**19257**  
(GM: 30006620;  
Toyota: 67771-12050)  
Maroon Nylon

Cowl Vent Screen &  
Door Trim Panel Retainer  
Chevrolet Geo, Metro & Tracker,  
Lexus And Toyota Celica,  
Corolla & Previa  
1989 - On

UNIT PACKAGE: 15



**20515**  
(6505918-AA)  
Yellow & White Nylon

Trim Panel Retainer  
Chrysler Caravan, Town & Country  
And Voyager Mini-Vans  
2001 - On

UNIT PACKAGE: 25



**14144**  
(GM: 95005064;  
Toyota: 67771-01010)  
Black Nylon

Door Trim Panel Retainer  
GM & Toyota  
1985 - On

UNIT PACKAGE: 25



**20622**  
(Chry: 6506311-AA)  
Yellow & White Nylon

Headliner Retainer  
Jeep Liberty  
2002 - On

UNIT PACKAGE: 15

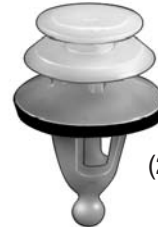

**18930**  
(22600612, 22651066)  
Yellow Nylon

Trim Panel Retainer  
GM 1996-On

UNIT PACKAGE: 25



**18862**  
(6503204)  
Green Nylon

Trim Panel Retainer  
Chrysler Cirrus & Stratus  
1995 - On

UNIT PACKAGE: 50



**18915**  
(6504014)  
White Nylon

Door Trim  
Panel Retainer  
Chrysler Caravan  
Cirrus, Neon, Ram Truck,  
Stratus & Voyager  
1995 - On

UNIT PACKAGE: 50



**17685**  
(6502991)  
Yellow Nylon

Trim Panel Retainer  
Cherokee Tail Gate  
& Trim Panel  
1993 - On

UNIT PACKAGE: 25



**17669**  
(6502907)  
Yellow Nylon

Trim Panel Retainer  
Jeep Grand Cherokee  
& Dodge Truck  
1993 - On

UNIT PACKAGE: 50



**19628**  
(6505539-AA)  
White Nylon

Door Trim Panel Retainer  
Jeep Grand Cherokee  
1999 - On

UNIT PACKAGE: 25



**19525**  
(10257286)  
Black Nylon

Door Trim Panel Retainer  
Chev. Venture, Olds Silhouette  
And Pontiac Trans Sport  
1997 - On

UNIT PACKAGE: 25



**20190**  
(W708621-S300)  
Caramel & Natural Nylon

Trim Panel Retainer  
Ford Taurus & Sable  
2000 - On

UNIT PACKAGE: 25



**19386**  
(6505292AA)  
Natural Nylon

Door Trim Panel Retainer  
Chrysler Vans  
1998 - On

UNIT PACKAGE: 25



# TRIMMING SUNDRIES & FASTENERS

**Sec. 19**

**Refer to Retainer Specification Chart on pages 381 - 387.**



**20616**  
(11519031)  
White Nylon

Door Panel Retainer  
With Sealer  
Hummer H2  
2003 - On

UNIT PACKAGE: 15



**20428**  
Not Available From  
O.E.M.  
Green & White Nylon

Door Trim Panel Retainer  
Chrysler Vans  
2001 - On

UNIT PACKAGE: 25



**19758**  
(25704141)  
Green Nylon

Trim Panel Retainer  
With Sealer  
Buick LeSabre &  
Pontiac Bonneville  
2000 - On

UNIT PACKAGE: 10



**20444**  
(15076791)  
White Nylon

Trim Panel Retainer  
GM Trucks: Rendezvous, S & T  
2002 - On

UNIT PACKAGE: 15



**20563**  
(5023173-AA)  
White Nylon

Door Trim Panel Retainer  
Jeep Liberty  
2002 - On

UNIT PACKAGE: 15



**19428**  
(22646099)  
White Nylon

Trim Panel Retainer  
With Sealer  
Chevrolet Cavalier &  
Pontiac Sunfire  
1995 - On

UNIT PACKAGE: 25



**20664**  
(11519030)  
Black Nylon

Door Panel Retainer  
Chevrolet Malibu  
2004 - On

UNIT PACKAGE: 15



**19775**  
(55350747AB)  
White Nylon

Door Trim Panel Retainer  
With Sealer  
Chrysler Mini-Vans  
1999 - On

UNIT PACKAGE: 15



**19803**  
Not Available From  
O.E.M.  
Green & White Nylon

Trim Panel Retainer  
With Sealer  
Dodge Neon  
2000 - On

UNIT PACKAGE: 10



**20427**  
Not Available  
From O.E.M.  
Gray & White Nylon

Door Trim Panel Retainer  
Chrysler Vans  
2001 - On

UNIT PACKAGE: 25



**19759**  
(25696693)  
White Nylon

Trim Panel Retainer  
With Sealer  
Cadillac DeVille & Seville  
1998 - On

UNIT PACKAGE: 10



**19804**  
(5023111AA)  
White Nylon

Trim Panel Retainer  
With Sealer  
Dodge Neon  
2000 - On

UNIT PACKAGE: 15

**Sec. 19****TRIMMING SUNDRIES & FASTENERS****Refer to Retainer Specification Chart on pages 381 - 387.****20357**  
(22607698)  
White NylonDoor Trim Panel Retainer With Sealer  
Oldsmobile Alero & Pontiac Grand  
AM  
1991 - On  
UNIT PACKAGE: 25**17075**  
(389144-S)  
White NylonTrim Panel Retainer  
Ford 1981 - On  
UNIT PACKAGE: 50**20338**  
(10421018)  
White NylonDoor Trim  
Panel Retainer  
GM  
1997 - On  
UNIT PACKAGE: 25**11797**  
(387477-S)  
White NylonInterior Trim Panel  
Ford 1977-On  
UNIT PACKAGE: 50**19356**  
(15986673)  
White NylonFront & Rear Door  
Trim Panel Retainer  
GM Trucks S10 & S15  
1996 - On  
UNIT PACKAGE: 50**19241**  
(6501863)  
Black NylonGarnish Moulding  
Retainer  
Dodge Dakota  
1994-On  
UNIT PACKAGE: 25**19527**  
(10408480)  
Yellow NylonDoor Garnish Moulding &  
Pillar Trim Panel Retainer  
Buick Century & Regal, Chev.  
Venture, Olds Intrigue & Silhouette,  
Pontiac Grand Prix  
and Trans Sport  
1997 - On  
UNIT PACKAGE: 25**19270**  
(10285935)  
White NylonTrim Panel Retainer  
Buick Century & Regal,  
Chevrolet Venture,  
GM Truck  
Express/Savana, Olds  
Silhouette & Pontiac  
Trans Sport  
1997 - On  
UNIT PACKAGE: 50**11349**  
(AMC: 4005099;  
GM: 796255;  
Chry: 6033862))  
Black NylonDoor Panel Retainer  
American Motors 1976-On  
GM 1988-81  
Jeep Wrangler 1991-On  
UNIT PACKAGE: 25**19275**  
(10287971)  
White NylonDoor Trim Panel Retainer  
Buick Century & Regal,  
Chevrolet Venture, Olds  
Silhouette and Pontiac  
Trans Sport 1997 - On  
UNIT PACKAGE: 50**16695**  
(10153057)  
White NylonDoor Trim  
Panel Retainer  
GM 1982 - On  
UNIT PACKAGE: 25**17100**  
(8934-202-428)  
White NylonDoor Trim Panel Retainer  
AMC Encore & Alliance 1986-On  
UNIT PACKAGE: 25**16938**  
(15638413, 15963179)  
Black NylonTrim Panel Retainer  
GM Trucks 1991 - On  
UNIT PACKAGE: 50

# TRIMMING SUNDRIES & FASTENERS

# Sec. 19

Refer to Retainer Specification Chart on pages 381 - 387.



**11701**

(6003368)  
Natural Nylon

Trim Panel Retainer  
Chrysler 1974-On

UNIT PACKAGE: 25



**13453**

(20480475)  
White Nylon

Rear Quarter  
Panel Retainer  
GM

UNIT PACKAGE: 50



**15669**

(10126901)  
White Nylon

Trim Panel Retainer  
GM 1987-On

UNIT PACKAGE: 50

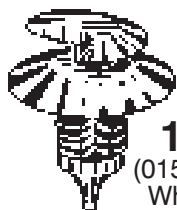

**13945**

(01553-S3500)  
White Nylon

Door Trim Panel Retainer  
Nissan Trucks

UNIT PACKAGE: 50



**19789**

(20387349)  
White Nylon

Radiator Air Baffle  
& Trim Panel Retainer  
Buick Century, Chevrolet Camaro &  
Cavalier, Oldsmobile Cutlass and  
Pontiac Firebird  
1982 - On

UNIT PACKAGE: 25



**10621**

(2064891,  
9818648,9883583)  
White Nylon

Door Trim Panel &  
Headliner Retainer  
GM 1971-On

UNIT PACKAGE: 50



**16017**

(363137)  
White Nylon

Trim Panel Retainer  
Chev. Truck &  
GMC 1976-On

UNIT PACKAGE: 100

**15461**

Same as 16017 except for packing

UNIT PACKAGE: 50



**13461**

(20451401)  
White Nylon

Retains Conduit to  
Sheet Metal in Doors  
GM

UNIT PACKAGE: 25

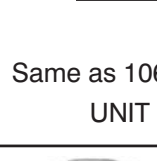

**16260**

Same as 10621 except for packing

UNIT PACKAGE: 100



**11774**

(9883583)  
White Nylon

Door Trim  
Panel Retainer  
GM 1971-On

UNIT PACKAGE: 50



**11678**

(Chry: 6003349;  
GM: 9685057;  
AMC: 4005470;  
VW: N98905101)  
White Nylon

Door Trim Panel Retainer  
Chrysler, GM, AMC & VW  
1976-On

UNIT PACKAGE: 25



**11672**

(387496-S)  
White Nylon

Trim Panel Retainer  
Ford 1976-On

UNIT PACKAGE: 25



**12737**

(12337920,  
20374473)  
White Nylon

Door Panel Retainer  
Camaro & Firebird 1982-On  
GM Truck 1989-On

UNIT PACKAGE: 50

**14524**

Same as 12737 except for packing

UNIT PACKAGE: 25

**Sec. 19****TRIMMING SUNDRIES & FASTENERS****Refer to Retainer Specification Chart on pages 381 - 387.****11796**  
(3065575)  
White NylonDoor Trim  
Panel Retainer  
GM  
1978-On

UNIT PACKAGE: 50

**16261**

Same as 11796 except for packing

UNIT PACKAGE: 100

**20369**  
(16659131)  
White NylonQuarter Trim Panel,  
Carpet &  
Rocker Panel  
Moulding Retainer  
Cadillac Concours, DeVille,  
Eldorado & Seville  
1994 - On

UNIT PACKAGE: 25

**17092**  
(20734005)  
Yellow NylonDoor Trim  
Panel Retainer  
GM 1982-On

UNIT PACKAGE: 50

**15970**  
(15545202, 15607165,  
15612948, 15953247)  
White NylonTrim Panel Retainer  
GM Trucks 1976-On

UNIT PACKAGE: 25

**13992**  
(20429451)  
White NylonDoor Trim  
Panel Retainer  
GM 1984-On

UNIT PACKAGE: 25

**20279**  
(25672428)  
White NylonTrim Panel Retainer  
With Sealer  
Buick LeSabre & Park Ave.,  
Cadillac DeVille & Seville,  
Oldsmobile Aurora &  
Pontiac Bonneville  
1998 - On

UNIT PACKAGE: 10

**18936**  
(N811006-S)  
Natural NylonTrim Panel Retainer  
Ford 1995-On

UNIT PACKAGE: 25

**11677**  
(GM: 20298365;  
Chry: 6013122)  
Natural NylonTrim Panel Retainer  
Chrysler 1976-On  
GM 1982-On

UNIT PACKAGE: 50

**19398**  
(12535713)  
Natural NylonQuarter Trim  
Panel Retainer  
Buick Riviera  
1995-On

UNIT PACKAGE: 25

**15670**  
(15545202)  
White NylonDoor Trim Panel Retainer  
GM Trucks 1988-On

UNIT PACKAGE: 50

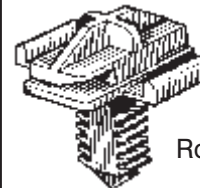
**14758**  
(D9AB-74519  
B18-AA)  
White NylonRoof Liner Moulding  
Retainer  
Ford Taurus &  
Sable 1986-On

UNIT PACKAGE: 25

**19400**  
(10093200,  
20036949)  
Gray NylonTrim Panel Retainer  
GM  
1977-On

UNIT PACKAGE: 25

**12992**  
(10073833,  
15600382,  
20421800)  
White NylonDoor Trim Panel Retainer  
GM 1983-On

UNIT PACKAGE: 25

**19524**  
(N807875-S)  
Green NylonDoor Trim Panel Retainer  
Lincoln Continental  
1995 - On

UNIT PACKAGE: 25

**17649**  
(15953247)  
White NylonTrim Panel Retainer  
GM C & K Trucks  
1993-On

UNIT PACKAGE: 50

**13946**  
(15588024,  
15596301)  
Yellow NylonSide & Rear Door  
Trim Retainer  
GM Astro & Safari  
Mini-Vans 1985-On

UNIT PACKAGE: 25

# TRIMMING SUNDRIES & FASTENERS

**Sec. 19**

Refer to Retainer Specification Chart on pages 381-387.

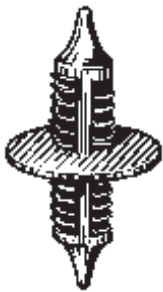

**17599**  
(15672328)  
Black Nylon  
Radiator Grille  
Retainer  
GM S-10 & S-15 Pick-Ups  
1991-On  
UNIT PACKAGE: 25

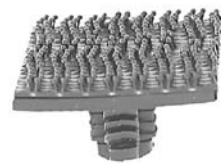

**19543**  
(10280777)  
Black Nylon  
Pillar Trim Panel, Roof Console Bracket &  
Headlining Trim Panel  
Retainer Chev. Lumina, Monte Carlo, Van & Venture,  
Olds Silhouette  
Pontiac And Trans Sport  
1996 - On  
UNIT PACKAGE: 10

## RETAINER SPECIFICATION CHART

Recommended Hole Size: .030"-.060" smaller than stem diameter.

Auveco Part No.	Type	Color	Bottom Head Diameter	Top Head Diameter	Stem Diameter	Stem Length	Page No.
3620	5	Black	13/32"		9/64"	7/16"	374
3639	5	White	3/8"		7/32"	7/16"	374
5592	5	Black	1/2"		9/32"	5/8"	374
8853	3	Natural	3/16" x 1/2"		3/16"	5/8"	373
10332	1	Black	1-1/4"		5/16"	1/2"	367
10621	9	White	3/4"	11/16"	5/16"	1/2"	379
10744	3	Black	3/16" x 1/2"		3/16"	7/16"	373
10831	1	Black	11/16"		5/16"	5/8"	365
10832	1	Gray	11/16"		5/16"	5/8"	365
11120	1	Black	13/32"		5/32"	3/8"	362
11129	1	Black	3/8"		7/32"	3/8"	362
11130	1	Black	.2"		5/16"	3/4"	371
11136	2	Black	1/2" x 1-1/2"		9/32"	5/8"	374
11146	1	Black	11/16"		5/16"	13/16"	366
11347	1	Black	3/4"		9/32"	1/2"	363
11349	8	Black	3/4"	19/32"	5/16"	11/16"	378
11350	1	White	1-7/32"		5/16"	1-1/16"	370
11351	1	Black	15/16"		5/16"	11/16"	368
11612	1	Black	7/16"		3/16"	5/8"	363
11671	6	Black	5/8"	1/2"	11/32"	1-1/8"	375
11672	8	White	15/16"	29/32"	5/16"	15/16"	379
11673	1	Natural	15/16"		5/16"	11/16"	368
11675	1	Natural	5/8"		5/16"	11/16"	363
11677	10	Natural	9/16"	3/8" x 9/16"	11/32"	11/16"	380
11678	8	White	15/16"	29/32"	5/16"	11/16"	379
11679	1	Black	3/4"		9/32"	1/2"	363
11680	1	Black	7/16"		3/16"	5/8"	362
11701	8	Natural	15/16"	5/8"	5/16"	11/16"	379
11721	1	Black	1/2"		9/32"	3/4"	362
11774	9	White	3/4"	11/16"	5/16"	1/2"	379
11796	9	White	7/8"	29/32"	5/16"	3/4"	380
11797	7	White	3/4"	1/2"	11/32"	9/16"	378
11842	1	Black	1-1/4"		5/16"	1-3/16"	370
12137	1	Black	1"		7/16"	13/16"	368
12565	6	Black	25/32"	1/2"	5/16"	5/8"	374
12571	1	Black	1"		5/16"	13/16"	368
12731	1	Black	25/32"		5/16"	15/16"	368
12737	9	White	3/4"	21/32"	5/16"	3/4"	379
12759	1	Black	1"		9/32"	1-7/16"	369
12766	1	Black	7/8"		7/16"	13/16"	368
12909	1	Black	1"		9/32"	1-1/16"	369
12992	11	White	3/4" x 7/8"	9/32" x 19/32"	5/16"	3/4"	380
12993	1	Black	1/2"		9/32"	11/16"	363, 551
13148	4	White	12mm		7.5mm	16mm	532
13179	8	Black	17mm	14mm	11mm	14mm	574
13198	1	Black	16mm		9mm	18mm	498
13202	4	Black	14mm		10mm	18mm	574
13453	8	White	15/16"	29/32"	5/16"	11/16"	379
13454	1	Black	21/32"		7/32"	15/32"	363
13461	8	White	15/16"	29/32"	5/16"	1-1/8"	379
13467	1	Black	1"		7/16"	1-7/16"	372
13470	6	White	3/4"	1/2"	5/16"	5/8"	375
13475	8	White	19mm	15mm	9mm	18mm	551, 574
13757	Misc.	Black	2" Sq.		1/4"	9/16"	374

These are general illustrations. There may be some differences between the actual part and the illustration. For clarification, refer to the true illustration referenced in the page number column in the chart.

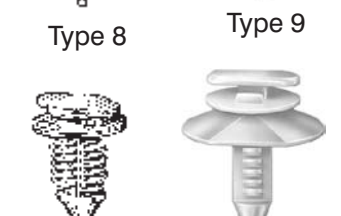
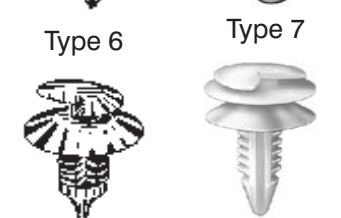
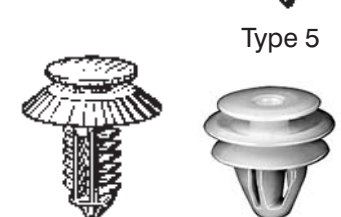
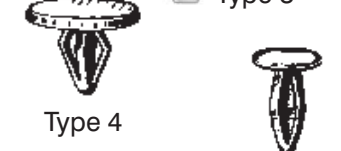
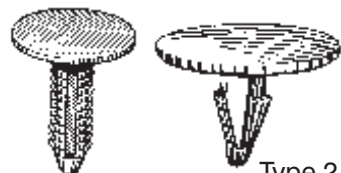

# Sec. 19

## RETAINER SPECIFICATION CHART

Recommended Hole Size: .030"-.060" smaller than stem diameter.

Auveco Part No.	Type	Color	Bottom Head Diameter	Top Head Diameter	Stem Diameter	Stem Length	Page No.
13945	8	White	3/4"	19/32"	9/32"	3/4"	379, 545
13946	10	Yellow	3/4" x 7/8"	9/32" x 19/32"	5/16"	3/4"	380
13992	9	White	23/32"	23/32"	5/16"	5/8"	380
14006	1	Black	3/8"	9/32"	9/32"	1/2"	362
14017	1	Black	1/2"	9/32"	9/32"	5/8"	363
14021	1	Black	7/16"	7/32"	7/32"	1/2"	362
14028	1	White	11/16"	5/16"	5/16"	9/16"	364
14032	1	Black	3/4"	5/16"	5/16"	1-1/4"	365
14035	1	Natural	19/32"	5/16"	5/16"	2"	365
14036	1	Black	3/4"	5/16"	5/16"	1-3/8"	365
14144	7	Black	18mm	13mm	9.5mm	14mm	376, 567
14163	2	Black	1-3/4"		3/8"	3/4"	371
14219	1	Black	1-1/2"		1/4"	1-3/16"	370
14269	7	White	18mm	13mm	9.5mm	14mm	526, 567
14270	7	Blue/Natural	18mm	13mm	9.5mm	14mm	567
14282	4	Black	13mm		7.5mm	15mm	508
14289	1	Black	13mm		5mm	16mm	509
14291	5	Black	11mm		5.5mm	13mm	508
14299	3	White	7mm x 16mm		6.5mm	5mm	511
14316	Misc	Black	18mm		8.5mm x 11mm	12mm	509
14319	4	Black	20mm		18mm	20mm	510
14323	4	Black	18mm		10mm	15mm	510
14328	3	White	6mm x 16mm		6mm	10mm	511
14347	4	Black	18mm		9mm	12mm	544
14348	4	Black	16mm		6.5mm	15mm	544
14349	5	Black	11mm		7mm	15mm	525, 543
14352	4	Black	13mm		6mm	13mm	543
14353	4	Black	14mm		10mm	16mm	544
14355	4	Black	11mm		6mm	13mm	543
14356	4	Black	20mm		11mm	16mm	544
14363	8	White	17mm	15mm	10mm	14mm	527
14367	1	Black	12mm		5mm	12mm	525
14380	4	Black	18mm		12mm	18mm	526
14524	9	White	3/4"	21/32"	5/16"	3/4"	379
14708	Misc	Gray	40mm		20.5mm	17mm	526
14709	1	Black	20mm		5.5mm	9mm	363, 526
14720	4	Black	18mm		12.5mm	15mm	537
14723	4	Black	14mm		9mm	11mm	544
14728	7	Natural/Yellow	16mm	12.5mm	8.5mm	11mm	565
14736	5	Black	14mm		6mm	10mm	563
14737	4	Black	13mm		7mm	15mm	543, 563
14738	4	Black	30mm		8mm	17mm	564
14757	1	Black	1/2"		1/4"	15/16"	364
14758	10	White	7/8" x 7/8"	3/8" x 7/8"	5/16"	19/32"	380
14857	1	Black	1/2"		9/32"	5/8"	363
14921	1	Black	10mm		6mm	12mm	363
14985	3	White	3/16" x 9/16"		1/8" x 11/32"	9/32"	372
15040	1	Black	3/4"		7/32"	11/16"	364
15050	1	Black	15mm		5.5mm	19mm	363
15367	1	Black	19/32"		7/32"	3/4"	363
15414	1	Black	11/16"		5/16"	13/16"	366
15456	1	Black	1-21/32"		5/16"	3/4"	370
15457	1	Black	1-3/8"		5/16"	15/16"	370
15461	8	White	3/4"	5/8"	5/16"	1"	379
15478	1	Black	22mm		11mm	28mm	368
15479	1	Black	26mm		8mm	38mm	369
15480	1	Black	25mm		8mm	20mm	367
15481	1	Black	25mm		7.5mm	20mm	367
15523	1	Black	1"		1/4" x 5/16"	1-1/8"	367
15543	1	Black	7/8"		5/16"	1-3/32"	366
15664	1	White	11/16"		5/16"	5/8"	365
15668	1	Black	1-3/4"		9/32"	1"	371
15669	8	White	15/16"	29/32"	5/16"	1-1/4"	379
15670	11	White	1/2"	1/4" x 29/64"	5/16"	3/4"	380
15695	10	White	15mm	8mm x 8mm	9.5mm	9mm	553
15707	7	Gray	17.5mm	13mm	10mm	14mm	567
15709	6	Natural	17.5mm	13mm	9.5mm	13mm	567
15970	11	White	9/16"-11/16"	9/32"-1/2"	5/16"	3/4"	380
15998	1	Black	30mm		6.5mm	9mm	509
16017	8	White	3/4"	5/8"	5/16"	1"	379
16132	1	Black	19mm		9mm	20mm	577
16259	1	Black	11/16"		5/16"	5/8"	365
16260	9	White	3/4"	11/16"	5/16"	1/2"	379
16261	9	White	7/8"	29/32"	5/16"	3/4"	380

These are general illustrations. There may be some differences between the actual part and the illustration. For clarification, refer to the true illustration referenced in the page number column in the chart.



Type 1



Type 2



Type 3



Type 4



Type 5

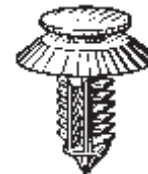

Type 6



Type 7



Type 8



Type 9



Type 10



Type 11

**RETAINER SPECIFICATION CHART**

Recommended Hole Size: .030"-.060" smaller than stem diameter.

Auveco Part No.	Type	Color	Bottom Head Diameter	Top Head Diameter	Stem Diameter	Stem Length	Page No.
16262	1	Black	7/8"		7/16"	13/16"	368
16263	1	Black	1"		7/16"	13/16"	368
16545	4	Black	16mm x 21.5mm		12mm	12mm	551
16695	7	White	20mm	18mm	8mm	23mm	378
16775	1	Black	20mm		4.5mm	15mm	509, 544
16776	1	Black	18mm		7.5mm	20mm	509, 544
16777	4	Black	15mm		12mm	15mm	526, 563
16778	8	Natural	18.5mm	14mm	11.5mm	14mm	527, 564
16779	4	Black	18mm		11mm	15mm	510, 563
16781	4	Black	15mm		8.5mm	20mm	509, 563
16818	1	Black	3/4"		11/32"	7/8"	364
16863	1	Black	1-3/4"		5/16"	29/32"	371
16938	7	Black	8mm	14mm	8mm	15mm	378
17004	2	Black	1-5/16"		3/8"	3/4"	371
17072	Misc	Black	1-1/2"		1-1/4"	5/16"	372
17075	7	White	3/4"	33/64"	5/16"	13/16"	378
17076	1	Black	18mm		7mm	23mm	366, 518
17092	11	Yellow	13/16" x 29/32"	5/8"	5/16"	3/4"	380
17100	8	White	21/32"	19/32"	21/64"	5/8"	378
17102	6	White	3/4"	1/2"	5/16"	1"	375
17124	6	Black	3/4"	1/2"	11/32"	3/4"	375
17205	4	Black	14mm		8mm	15mm	510
17215	1	Black	40mm		8mm	13mm	371
17218	6	Natural	20mm	13mm	8mm	18mm	375
17237	Misc	Black	38mm		7mm	9mm	372
17339	3	Black	5mm x 15mm		4mm	12mm	372
17381	1	Gray	32mm		8mm	20mm	370
17452	5	White	13mm		5mm	15mm	543
17453	1	Gray	15mm		6.5mm	14mm	363, 526
17599	1	Black	3/4"		9/32" x 11/32"	11/16"	381
17612	1	Black	5/8"		3/8"	3/4"	366
17634	1	Black	12mm		6mm	16mm	543
17649	10	White	1/2" x 5/8"	9/32" x 1/2"	5/16"	7/8"	380
17664	1	Black	11/16"		5/16"	1-1/16"	366
17669	7	Yellow	23/32"	1/2"	5/16"	9/16"	376
17685	7	Yellow	18mm	13mm	8mm	25mm	376
17975	2	Black	1-3/16"		5/16"	1/2"	371
17985	7	White	14mm	8mm	9mm	13mm	375
17990	4	Black	14mm x 15mm		7mm	19mm	520
17991	3	White	8mm x 17mm		8mm	14mm	520
18033	3	White	1/4" x 21/32"		1/4"	15/32"	373
18087	2	Gray	1-3/8"		9/32"	5/8"	372
18089	2	Blue	1-3/8"		9/32"	5/8"	372
18114	4	Black	10mm		7.5mm	10mm	493, 510
18157	4	Gray	13mm		5mm	16mm	508
18158	1	Black	1/2"		3/8"	15/32"	362
18166	Misc	Black	10mm		4mm	10mm	545
18174	1	Black	3/4"		5/16"	13/16"	364
18175	6	Natural	15/16"	1/2"	5/16"	15/16"	375
18248	2	Black	7/16"		11/64"	3/8"	374
18271	5	Black	14mm		6mm	15mm	526
18275	1	Blue	1"		5/16"	1-1/2"	369
18277	1	Gray	1"		5/16"	1-1/2"	369
18294	7	White	18mm	13mm	9.5mm	14mm	511
18297	4	Black	13mm		7.5mm	11mm	374, 563
18298	1	Black	1/2"		5/16"	11/16"	362
18301	1	Black	3/4"		11/32"	1-3/16"	364
18302	1	Black	7/16"		7/32"	15/32"	362
18330	3	White	3/16" x 37/64"		11/64"	9/16"	373
18371	1	Gray	3/4"		5/16"	1-1/4"	365
18379	1	Black	23/32"		5/16"	7/8"	364
18389	1	Black	1/2"		9/32"	7/16"	362
18391	6	Natural	3/4"	1/2"	5/16"	1-5/32"	375
18458	4	Black	14mm		6mm	10mm	374, 525
18508	3	Black	3/16" x 19/32"		15/32"	5/16"	373
18509	3	Natural	9/32" x 35/64"		1/2"	9/32"	373
18510	3	Natural	3/16" x 1/2"		13/64"	13/32"	373
18679	1	Gray	1"		7/16"	13/16"	368
18680	1	Black	1-1/32"		9/32"	1-3/32"	369

These are general illustrations. There may be some differences between the actual part and the illustration. For clarification, refer to the true illustration referenced in the page number column in the chart.



Type 1

Type 2



Type 3



Type 4



Type 5



Type 6



Type 7



Type 8



Type 9



Type 10



Type 11

**RETAINER SPECIFICATION CHART**

Recommended Hole Size: .030"-.060" smaller than stem diameter.

Auveco Part No.	Type	Color	Bottom Head Diameter	Top Head Diameter	Stem Diameter	Stem Length	Page No.
18682	1	Black	1/2"		1/4"	3/4"	363
18683	1	Black	23/64"		3/16"	7/16"	362
18684	1	Black	3/8"		5/32"	3/8"	362
18685	1	Black	31/32"		9/32"	3/4"	367
18686	1	Black	1/2"		19/64"	25/32"	363
18688	1	Gray	1-1/32"		9/32"	1-3/32"	369
18692	3	Natural	5mm x 15mm		5mm	10mm	526, 564
18746	1	Black	30mm		6mm	10mm	494, 509
18770	1	Black	3/8"		7/32"	5/8"	362
18771	1	Black	1"		19/64"	1-1/16"	369
18815	1	Black	9/16"		5/16"	3/4"	363
18818	3	Natural	7mm x 16mm		5mm	12mm	511
18820	1	Black	3/4"		7/32"	1/2"	363
18824	7	White	15mm	13mm	9mm	9.5mm	375, 526
18826	1	Black	1-3/64"		9/32"	7/16"	368
18827	2	Black	25/32"		5/16"	7/16"	374
18841	4	Natural	12mm		6mm	9mm	563
18842	4	Black	30mm		8.5mm	17mm	564
18844	7	White	18mm	13mm	10mm	13mm	566
18848	6	Yellow	3/4"	1/2"	3/8"	11/16"	375
18859	1	Black	19/32"		5/16"	1-3/8"	364
18861	6	White	18mm	13mm	8.5mm x 8.5mm	12mm	565
18862	7	Green	23/32"	19/32"	5/8"	1/4"	376
18874	7	Gray	18mm	13mm	9.5mm	15mm	568
18875	6	White	19mm	13mm	11mm	15mm	565
18876	7	White	18mm	13mm	9mm x 9mm	14mm	376, 566
18877	3	Orange	5mm x 15mm		6mm	10mm	493, 571
18878	4	Black	30mm		6mm	16mm	564
18897	1	Black	13/32"		13/64"	7/8"	364
18915	7	White	23/32"	1/2"	5/16"	9/16"	376
18930	7	Yellow	18mm	13mm	9mm	18mm	376
18936	11	White	19/32"	39/64" x 7/16"	5/16"	1/2"	380
18948	1	Black	7/16"		7/32"	11/16"	362
18950	7	Blk&Wht	18mm	13mm	10mm	13mm	566
19015	7	Natural	18mm	13mm	10mm	12mm	566
19016	7	Dk Gray	18mm	13mm	9.5mm	14mm	568
19108	7	Natural	18mm	13mm	9.5mm	14mm	567
19109	7	Natural	13mm	13mm	9.5mm	11mm	565
19112	5	Black	30mm		8mm	16mm	564
19113	4	Black	25mm		8mm	12mm	520, 563
19114	4	Black	12mm		8.5mm	9mm	494, 510
19116	3	Natural	5mm x 15mm		6mm	10mm	511
19121	1	Gray	20mm		8mm	20mm	562
19122	5	Natural	15mm		8mm	12mm	563
19123	1	Black	17mm		7mm	12mm	564
19124	4	Black	16mm		10mm	10mm	563
19127	1	Black	1"		1/4"	25/32"	367
19129	7	Yellow	18mm	13mm	9.5mm	17mm	568
19145	7	Gray	17mm	13mm	9mm	12mm	494, 510
19149	1	Black	3/8"		7/32"	5/8"	362
19155	2	Black	1-9/32"		3/8"	3/4"	372
19171	3	Green	5mm x 15mm		5mm	10mm	511
19197	1	Gray	25mm		8mm	20mm	367
19203	7	Natural	18mm	13mm	11mm	11mm	565
19210	7	Natural	18mm	13mm	10mm	14mm	568
19213	6	Natural	3/4"	1/2"	11/32"	3/4"	375
19229	4	Black	17mm x 22mm		10mm	13mm	494, 510
19230	1	Gray	25mm		9mm	11mm	494
19241	8	Black	11/16"	9/16"	9/32" x 21/64"	5/8"	378
19250	1	White	11/16"		5/16"	13/16"	366
19256	7	Dark Gray	18mm	13mm	9.5mm	14mm	567
19257	7	Maroon	18mm	13mm	9mm	14mm	376, 566
19270	7	White	20mm	18mm	8mm	24mm	378
19275	7	White	20mm	18mm	8mm	13mm	378
19312	1	Black	16mm		5mm	13mm	562
19320	6	White	16mm	12mm	9mm	11mm	538
19321	10	White	16.3mm	13mm x 14mm	9mm	16mm	538
19323	4	Black	26mm		10mm	8mm	537
19325	3	Brown	5mm x 13mm		7mm	6mm	538
19327	6	Natural	13mm	18mm	9mm	17mm	545
19331	4	Black	14mm		7mm	11mm	537
19332	1	Gray	22mm		6.5mm	12mm	537

These are general illustrations. There may be some differences between the actual part and the illustration. For clarification, refer to the true illustration referenced in the page number column in the chart.

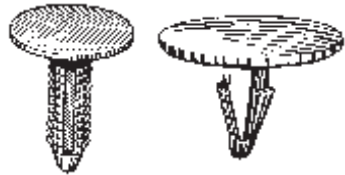

Type 1                      Type 2



Type 3                      Type 4



Type 5                      Type 6



Type 7                      Type 8

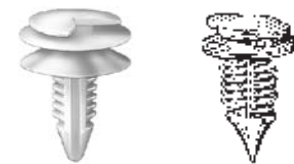

Type 9                      Type 10



Type 11



**RETAINER SPECIFICATION CHART**

Recommended Hole Size: .030"-.060" smaller than stem diameter.

Auveco Part No.	Type	Color	Bottom Head Diameter	Top Head Diameter	Stem Diameter	Stem Length	Page No.
19334	6	Natural	16mm	12mm	9mm	15mm	538
19338	1	Black	1-1/4"		5/16"	11/16"	370
19352	1	Gray	3/4"		5/16"	1-7/16"	365
19354	1	Tan	3/4"		5/16"	1-7/16"	365
19356	7	Black	20mm	18mm	8mm	20mm	378
19368	3	Natural	5mm x 15mm		5mm	9mm	372
19371	1	Blue	19/32"		9/32"	27/32"	366
19372	1	Dark Gray	19/32"		9/32"	27/32"	366
19373	1	Light Gray	19/32"		9/32"	27/32"	366
19374	1	Tan	19/32"		9/32"	27/32"	366
19382	1	Mist Gray	1-3/8"		9/32"	1/2"	370
19383	1	Camel Tan	1-3/8"		9/32"	1/2"	370
19384	1	Silver Fern	1-3/8"		9/32"	1/2"	370
19385	4	Gray	26mm		10mm	8mm	369, 537
19386	7	Natural	20mm	15mm	9mm	15mm	376
19398	11	Natural	17mm	4mm x 9mm	8mm	18mm	380
19400	10	Gray	3/4"	3/8" x 5/8"	5/16"	1-1/16"	380
19418	1	Black	13/32" x 1"		9/32"	9/16"	373
19425	3	Natural	9/32" x 1/2"		7/32"	21/32"	373
19428	Misc	White	20mm	18mm	8mm	19mm	377
19449	1	Black	13/64" x 7/8"		7/32"	5/8"	373
19464	6	Natural	16mm	13mm	8.5mm	13mm	494
19466	7	White	17mm	13mm	9.5mm	12mm	494
19467	4	Black	13mm		6mm	10mm	493
19468	1	Black	28mm		6mm	10mm	517
19470	1	Black	16mm		4mm	21mm	509
19471	1	Black	13/16"		7/32"	13/16"	364
19481	3	Blue	5mm x 15mm		6mm	8mm	527
19483	3	Black	8mm x 18mm		7mm	15mm	494, 511
19501	1	Tan	1-1/32"		9/32"	1-1/32"	369
19506	1	Black	16mm		5mm	16mm	493, 509
19524	Misc	Green	15mm		8mm	13mm	380
19525	7	Black	22mm	18mm	8mm	8mm	376
19527	7	Yellow	20mm	18mm	8mm	13mm	378
19532	Misc	Black	5/8"		5/16"	5/32"	372
19540	1	Black	23mm		6mm	13mm	367
19541	1	Black	1"		9/32"	5/8"	367
19543	Misc	Black	1" Square		23/64"	15/32"	381
19544	10	Black	13mm	9mm x 12mm	7.5mm	9mm	511
19628	7	White	18mm	15mm	8.5mm	14mm	376
19643	1	Black	16mm		6mm	16mm	562
19655	2	Black	1-3/16"		3/8"	3/4"	371
19667	1	Black	3/4"		7/32"	11/16"	363
19673	1	Black	10mm x 15mm		5mm	10mm	511
19674	1	Gray	19mm		6mm	10mm	509
19678	3	White	5mm x 15mm		6mm	10mm	373
19682	4	Black	11mm		7mm	8mm	510
19683	3	Black	6mm x 16mm		7mm	14mm	511
19684	3	Blue	7mm x 16mm		6mm	12mm	545
19686	1	Black	12mm		5mm Sq.	6mm	562
19719	7	White	18mm	13mm	10mm	11mm	565
19720	3	Blk/White	8mm x 17mm		7mm	16mm	568
19724	3	White	6mm x 16mm		6mm	15mm	545
19728	3	Black	8mm x 17mm		7mm	14mm	568
19729	4	Black	25mm		9mm	10mm	520, 563
19731	7	White	17mm	13mm	9.5mm	13mm	545
19744	1	Black	16mm		6mm	27mm	509
19749	3	White	5mm x 15mm		6mm	10mm	564
19758	Misc	Green	19mm	19mm	8mm	20mm	377
19759	Misc	White	19mm	19mm	8mm	23mm	377
19760	1	Black	25mm		8mm	24mm	367
19761	1	Tan	25mm		8mm	24mm	367
19762	1	Graphite	25mm		8mm	24mm	367
19763	1	I.D. Graphite	25mm		8mm	24mm	367
19774	1	Black	13/32"		5/16"	1-5/16"	364
19775	Misc	White	18mm	13mm	8mm	18mm	377
19789	8	White	15/16"	3/4"	5/16"	3/4"	379
19790	1	Gray	11/16"		5/16"	13/16"	366
19802	7	White	16mm	12mm	8mm	24mm	374

These are general illustrations. There may be some differences between the actual part and the illustration. For clarification, refer to the true illustration referenced in the page number column in the chart.

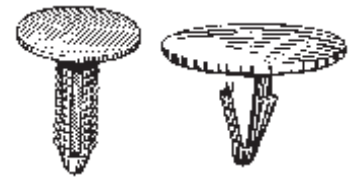

Type 1

Type 2



Type 3

Type 4

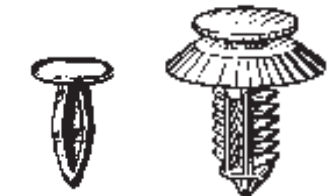

Type 5

Type 6



Type 7

Type 8



Type 9

Type 10



Type 11

# Sec. 19

## RETAINER SPECIFICATION CHART

Recommended Hole Size: .030"-.060" smaller than stem diameter.

Auveco Part No.	Type	Color	Bottom Head Diameter	Top Head Diameter	Stem Diameter	Stem Length	Page No.
19803	Misc	Green/White	22mm	16mm	9mm	15mm	377
19804	Misc	White	22mm	16mm	9mm	15mm	377
19810	6	Black	13mm	12mm	8mm	19mm	374
19834	1	Black	3/4"		5/16"	1-1/16"	366
19836	1	Black	7/16"		7/32"	11/16"	362
19837	1	Black	3/4"		11/32"	13/16"	366
19842	Misc	Black	18mm		11mm	22mm	563
19845	1	M. Graphite	1"		5/16"	1-3/4"	369
19846	1	Black	1"		5/16"	1-3/4"	369
19850	3	Natural	5mm x 15mm		5mm	8mm	373
19855	1	Black	23/32"		15/64" x 9/32"	3/4"	365
19893	1	Black	5/8"		1/4"	3/4"	364
19898	7	Yellow	18mm	13mm	9.5mm	13mm	567
19906	7	Black	18mm	12mm	11.5mm	11mm	526
19910	7	Yellow	18mm	13mm	9mm x 9mm	14mm	566
20164	2	Black	30mm			12mm	371
20165	1	Black	10mm		6mm	12mm	362
20167	1	Black	22mm		6mm Sq.	16mm	544
20174	7	Maroon	18mm	13mm	9.5mm	14mm	567
20177	1	Gray	11/16"		5/16"	1-3/8"	364
20178	1	Black	14mm		8mm	30mm	364
20180	3	Black	6.5mm x 11mm		5.5mm	12mm	373
20181	3	White	6.5mm x 16mm		6mm	8mm	372
20182	3	White	6.5mm x 16mm		6mm	6mm	373
20183	3	Black	6.6mm x 16mm		6mm	9mm	373
20184	1	Black	16mm		8mm	16mm	562
20188	7	White	18mm	13mm	8.5mm	11mm	532
20189	1	Black	1"		5/16"	5/8"	367
20190	Misc	Cr/White	20mm	13mm	8.5mm	16mm	376
20192	1	Black	11/16"		5/16"	1-3/4"	365
20251	7	White	18mm	12mm	7mm	20mm	574
20252	7	Black	18mm	14mm	9mm	14mm	574
20253	7	White	18mm	14mm	9mm	15mm	497
20256	1	Black	15mm		4.5mm	14mm	544
20262	1	Black	1"		7/16"	9/16"	368
20274	6	White	23mm	13mm	6.5mm	20mm	374
20279	Misc	White	13/16" x 1-7/16"	5/16" x 3/4"	5/16"	7/8"	380
20281	1	Black	21mm		13mm	27mm	368
20305	1	Gray	25mm		7mm	20mm	562
20311	1	Black	14mm		7mm	9mm	362
20316	1	Black	1"		5/16"	13/16"	368
20319	1	Black	25mm		9mm	12mm	367
20332	1	Black	23/32"		5/16"	7/16"	363
20334	1	Gray	18mm		7.5mm	20mm	509
20338	7	White	25/32"	11/16"	5/16"	1-1/4"	378
20341	Misc	Black	22mm		10.5mm	10mm	574
20344	1	Black	7/16"		7/32"	5/16"	362
20345	1	Gray	1"		1/4" x 5/16"	1-1/8"	369
20357	Misc	White	20mm	13mm	9mm	18mm	378
20360	1	Black	15/16"		3/8"	3/4"	367
20361	1	Black	22mm		7mm	18mm	364
20362	1	Black	25mm		13mm	15mm	368
20366	1	Black	22mm		7.5mm	35mm	365
20369	11	White	20mm x 24mm	13mm/19mm	7mm/8mm	18mm	380
20381	5	Black	16mm		7mm	16mm	508, 544
20399	1	Black	3/4"		7/32"	15/32"	363
20411	7	Black	14.5mm	13mm	9.5mm	12mm	494, 510
20427	7	Gray & White	20mm	15mm	9mm	18mm	377
20428	7	Green/White	20mm	15mm	9mm	18mm	377
20437	7	White	18mm	13mm	8.5mm x 8.5mm	15mm	566
20438	1	Gray	25mm		6mm	17mm	562
20439	7	White	18mm	13mm	11mm	12mm	565
20443	3	Black	5mm x 15mm		7mm	10mm	564
20444	7	White	19mm	20mm	11mm	17mm	377
20456	1	Natural	1/2"		5/16"	13/16"	362
20459	7	Black	16mm	15mm	9mm	10mm	527
20460	6	Black	18mm	14mm	9mm	13mm	526
20467	Misc	Black	21mm	16mm	6mm	25mm	375
20473	7	White	18mm	13mm	11mm	14mm	520, 565
20515	7	Yel/White	20mm	15mm	9mm	14mm	376
20528	1	Black	9mm		6mm	14mm	362
20531	1	Black	21mm		7.5mm	25mm	364
20541	1	Tan	35mm		7.5mm	20mm	370
20543	4	Black	26mm		12mm	14mm	518
20558	7	White	15mm	13mm	8.5mm x 9mm	11mm	520, 565

These are general illustrations. There may be some differences between the actual part and the illustration. For clarification, refer to the true illustration referenced in the page number column in the chart.

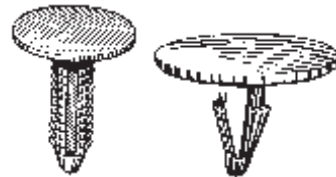

Type 1

Type 2

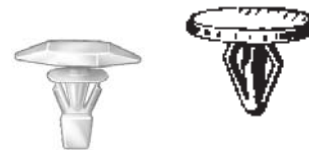

Type 3

Type 4

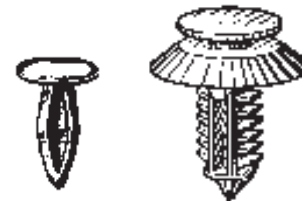

Type 5

Type 6



Type 7

Type 8



Type 9

Type 10



Type 11

**RETAINER SPECIFICATION CHART**

Recommended Hole Size: .030"-.060" smaller than stem diameter.

Auveco Part No.	Type	Color	Bottom Head Diameter	Top Head Diameter	Stem Diameter	Stem Length	Page No.
20559	7	Blue	18mm	13mm	9mm x 9mm	11mm	375, 565
20563	7	White	22mm	16mm	9mm	15mm	377
20571	7	White	18mm	13mm	9mm	9mm	538
20572	Misc	White	16mm	12mm	8mm	14mm	535
20575	7	Yel/White	18mm	13mm	10mm	13mm	520, 566
20576	Misc	Yellow	14mm x 18mm	10mm/13mm	8.5mm/8.5mm	9mm	374, 564
20609	1	Black	30mm		15mm x 20mm	14mm	494, 509
20610	7	White	16mm	13mm	9mm	15mm	510
20611	6	Blue	16mm	12mm	3mm	7mm	510
20615	1	Black	35mm		8mm	20mm	370
20616	7	White	18.5mm	19.5mm	11mm	17mm	377
20622	7	Yel/White	20mm	15mm	9mm	17mm	376
20624	1	Black	18mm		7.5mm	33mm	364
20625	1	Tan	25mm		8mm	29mm	369
20633	7	Turquoise	18mm	13mm	8.5mm x 9mm	14mm	566
20634	6	White	16mm	13mm	7mm	26mm	374
20642	6	Gray	16mm	13mm	9mm	13mm	532
20643	Misc	Black	13mm		6.5mm	11mm	532
20644	1	Natural	4mm/6.5mm		4mm	8mm	532
20664	7	Black	18.5mm	19.5mm	11mm	16mm	377
20668	7	White	18mm	13mm	9mm	14mm	517, 545
20669	7	Black	18mm	13mm	9mm	15mm	517, 545
20670	7	Gray	18mm	13mm	8.5mm	12mm	545
20671	1	Black	20mm		9.5mm	15mm	544
20672	6	White	16mm	13mm	4mm	13mm	545



Type 1



Type 6



Type 7



**15301**

Clip Removal Tool

The right tool for removing clips and retainers quickly and easily. Simply seat the tool on the shaft of the fastener and squeeze the handles together. Made of high carbon steel and heat treated for strength. Zinc plated with vinyl molded handle grips.

UNIT PACKAGE: 1

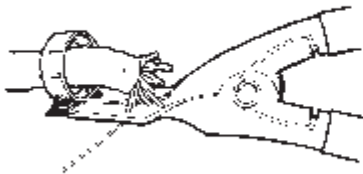

• Wiring Stays



• Hood Insulation

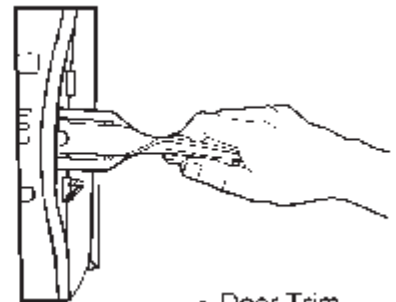

• Door Trim

**TRUCK SEAT SPRINGS**

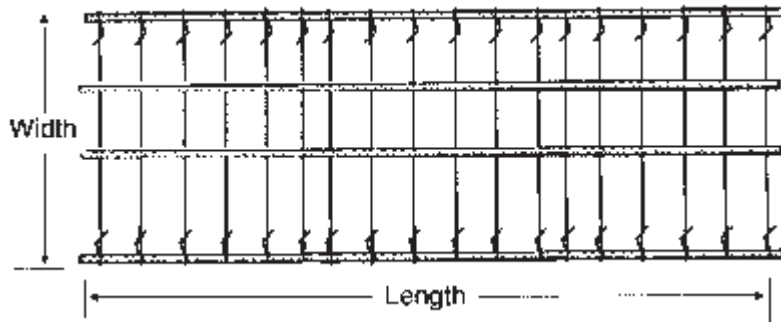

**16208**

(14021204)

GM 1/2 Ton Pick-Ups  
Length: 50" Width: 15-1/4"  
No. of Wires: 50

UNIT PACKAGE: 5

**16213**

(E0TB-1063-226AC,  
E3TB-1063-226AA)

Ford Full Size Pick-Ups  
& Light Truck 1980-On  
Length: 52" Width: 16-3/4"  
No. of Wires: 52

UNIT PACKAGE: 5

**16214**

(E27B-1063-226AC)

Ford Ranger, Courier & Yuma 1982-On  
Length: 45" Width: 14-3/4"  
No. of Wires: 45

UNIT PACKAGE: 5



Side View

**7895**

For: Repairing Truck Seats w/Foam Rubber  
End Wire - Heavy Gauge  
Right or Left Side  
Length 5" - Formed Actual Size  
Component of No. 3822092  
Chevrolet & GMC Trucks Deluxe 1968-61

UNIT PACKAGE: 20

Side View



**7741**

For: Repairing Truck Seats  
End Wire - Right or Left Side  
Length: 7-1/2" - Formed Actual Size  
All GM Trucks 1965-59

UNIT PACKAGE: 10



**Wire Bending Tool**

For Truck Seat Springs

**16894**

A tough tool that makes difficult wire repairs easy. You can bend the ends of no sags, edgewise and foam springs right on the spot, making offsets where you need them. Can be readily mounted in a vise for duplicating complex repetitive wire bends. Constructed of heat-hardened steel for long life.

UNIT PACKAGE: 1

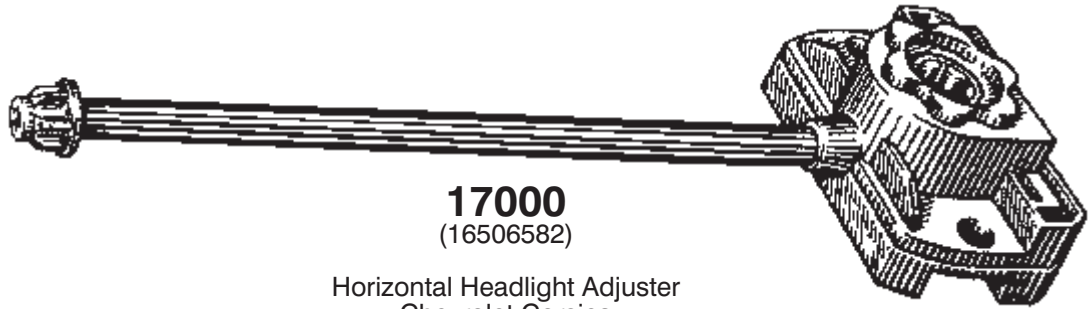

**17000**  
(16506582)

Horizontal Headlight Adjuster  
Chevrolet Corsica  
& Lumina (APV),  
Olds Silhouette (APV)  
and Pontiac Trans  
Sport (APV)  
1987-On

UNIT PACKAGE: 2



**11243**  
(343543, 343555,  
354076, 362379)

1/4"-28 x 2"  
Headlight Adjusting Screw & Nut Assembly  
GM 1962-On

UNIT PACKAGE: 10

**11244**

Same as 11243 except packing

UNIT PACKAGE: 100



**11245**  
(343543, 343555,  
354076, 362379, )  
Nylon

Headlight Adjusting Nut  
GM 1962-On

UNIT PACKAGE: 50



**11246**  
(343543, 354076,  
9438150, 15705372)  
Zinc

1/4"-28 x 2"  
Headlight Adjusting Screw  
GM 1962-On

UNIT PACKAGE: 25

Visit The  
 Auveco Web Site At  
[www.auveco.com](http://www.auveco.com) For  
 The latest Information  
 On New Items.



**11826**  
 (365270)  
 Green Nylon

1/4"-28 x 2"  
 Headlight Adjusting  
 Screw & Nut  
 Assembly  
 Cars with Fiberglass  
 Panels  
 GM 1976-On

UNIT PACKAGE: 25

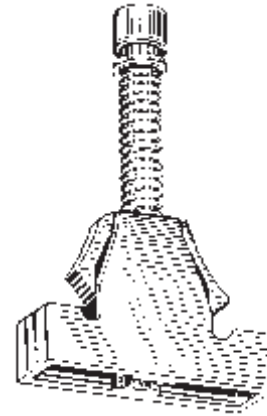

**11655**  
 (557057, 559312)  
 Nylon

#12-28 x 1-3/4"  
 Headlight Adjusting Screw & Nut  
 Assembly  
 GM 1975-On

UNIT PACKAGE: 25

**11656**

Same as 11655 except packing

UNIT PACKAGE: 100

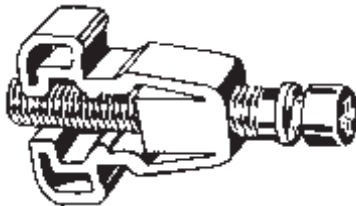

**11470**

(GM: 1606642,  
 1618890,  
 AMC: SF 400 6204)

1/4"-28 x 1-7/8"  
 Headlight Adjusting Screw & Nut  
 Assembly  
 Cadillac 1975-On & AMC

UNIT PACKAGE: 25



**11718**

(365270)  
 Green Nylon

Headlight Adjusting Nut  
 For Cars With Fiberglass Panels  
 GM  
 1976-On

UNIT PACKAGE: 50

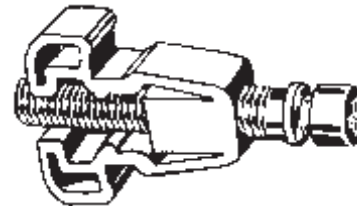

**11657**

(1606642,  
 1618890)

1/4"-28 x 1-7/8"  
 Headlight Adjusting Screw & Nut  
 Assembly  
 Cadillac & Oldsmobile 1975-On

UNIT PACKAGE: 100

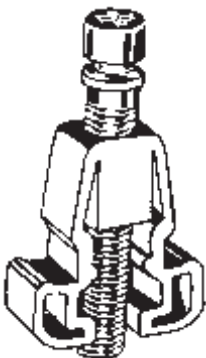

**10759**  
 (1600375)

1/4"-28 x 1-1/2"  
 Headlight Adjusting Screw & Nut  
 Assembly  
 Cadillac 1976-72

UNIT PACKAGE: 10

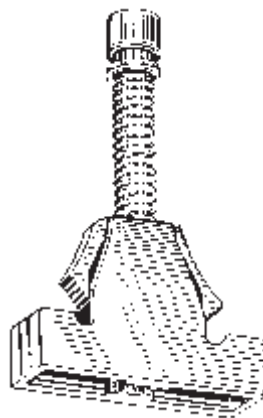

**11665**

(556196, 557057)  
 Nylon

#12-28 x 1-3/4"  
 Headlight Adjusting Screw  
 & Nut Assembly  
 GM 1975-On

UNIT PACKAGE: 25

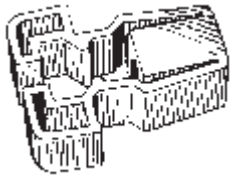

**11659**  
(1606642, 1618890)  
Nylon

Headlight Adjusting Nut  
Use with 1/4"-28 Screw  
Cadillac & Oldsmobile 1975-On

UNIT PACKAGE: 50

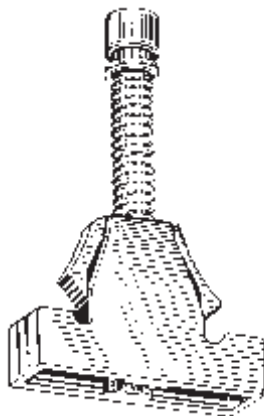

**11667**  
(556539)  
Nylon

#12-28 x 1-3/4"  
Headlight Adjusting Screw & Nut  
Assembly  
Buick & Oldsmobile 1977-On

UNIT PACKAGE: 25

"If A Picture Is Worth  
A Thousand Words,  
Then A Sample  
Is Worth A  
Thousand Pictures."  
**"Pop" Gale**

Call Our  
Customer Service  
Department When You  
Need A Sample...

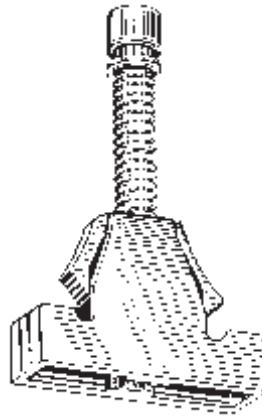

**12605**  
(22512857, 22513813)  
Nylon

#12-28 x 1-3/4"  
Headlight Adjusting Screw & Nut  
Assembly  
Camaro & Firebird 1975-On

UNIT PACKAGE: 10

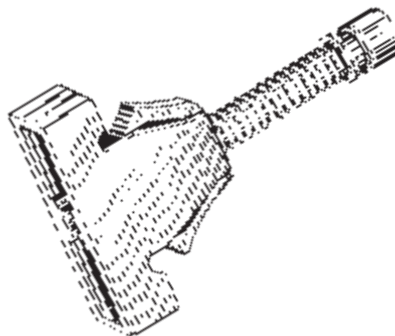

**11871**  
(559312)  
Nylon

#12-28 x 1-11/16"  
Headlight Adjusting  
Screw & Nut Assembly  
Chevrolet, Oldsmobile & Pontiac  
1975-On

UNIT PACKAGE: 10



**5788**  
Nylon

Headlight Adjusting Nut  
Chevrolet: All Early Models

UNIT PACKAGE: 50



**19549**  
(16506617)  
Black Nylon

Headlight Adjuster Pivot  
Fits Into 13mm Square Hole  
Regal, Concours, Eldorado,  
Seville, Caprice, Lumina, Full-  
Size Van, Cutlass, Grand Am &  
Grand Prix  
1987 - On

UNIT PACKAGE: 25



**9851**  
(3921446)  
White Nylon

Headlight Adjusting Nut  
Use With 1/4"-28 Screw  
Chevrolet

UNIT PACKAGE: 50



**5789**

Headlight Adjusting Screw & Nut  
Assembly  
Chevrolet

UNIT PACKAGE: 25 Sets



**3209**  
Zinc

1/4"-28 x 1"  
Headlight Adjusting Screw  
UNIT PACKAGE: 50

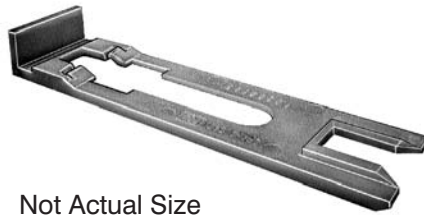

Not Actual Size

**19486**  
(10298115)  
Natural Nylon

Headlight Retainer  
Buick Century & Regal  
And Oldsmobile Intrigue  
1997-On

UNIT PACKAGE: 10

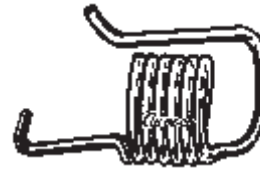

**11252**  
(413851, 22537990)

Headlight Adjusting Spring  
GM 1990-75

UNIT PACKAGE: 10

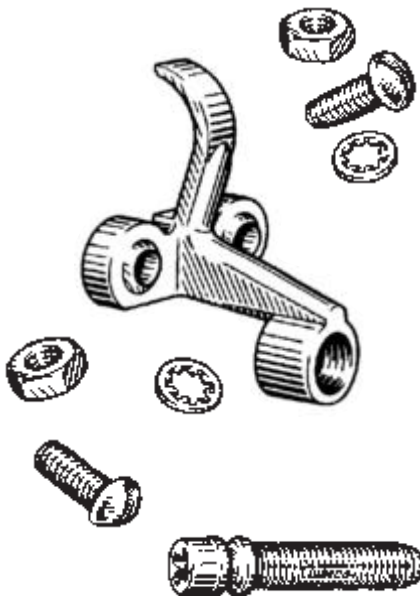

**3178**  
(5949838)

Headlight Adjusting Screw & Nut  
Assembly  
Chevrolet, Buick & Pontiac  
UNIT PACKAGE: 10 Sets



**10090**  
(3923948)

Headlight Adjusting Spring  
Chevrolet 1968-On

UNIT PACKAGE: 25



**12136**  
(25501771)

#8 Screw  
Headlight Panel Retainer  
GM 1979-80

UNIT PACKAGE: 50

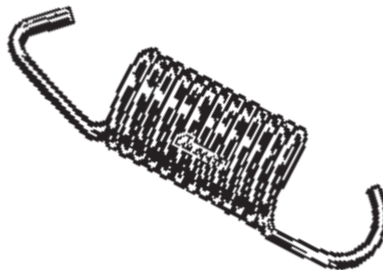

**11253**  
(3455559)

Headlight Adjusting Spring  
Chevrolet 1977-75

UNIT PACKAGE: 10



**18928**  
(12337918)  
Black Phosphate

Headlight Opening  
Moulding Fastener  
Pontiac Bonneville  
1991-87

UNIT PACKAGE: 25



**20378**

Not Supplied By O.E.M.  
White Nylon

Headlight Adjusting Screw Nut  
**Component of Auveco 3178**  
Headlight Adjusting Screw Assy.  
Buick, Chevrolet & Pontiac

UNIT PACKAGE: 25

**Visit The  
Auveco Web Site At  
[www.auveco.com](http://www.auveco.com)  
For The Latest  
Information  
On New Items.**

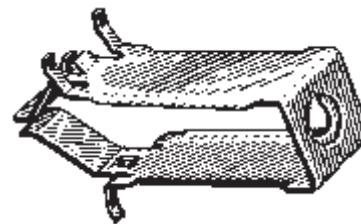

**14821**  
(22514924)

Headlight Mounting Bezel Nut  
Screw Size: #8 (M4.2-1.41)  
2" Long  
Oldsmobile 1982-On

UNIT PACKAGE: 25



# GENERAL MOTORS CLIPS & FASTENERS **Sec. 20**

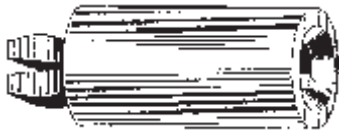

**8942**  
(3863669)  
Nylon

Radiator Grille to Headlight Nut  
#8 or #10 Screw Size  
Chevrolet

UNIT PACKAGE: 25



**20433**  
(3547221)  
Yellow Nylon

Nylon Nut  
#6 Screw Size  
Head Size: 3/8" x 3/8"  
Moulding Attachment  
1994 - On

UNIT PACKAGE: 50



**13450**  
(347347)  
Natural Nylon

Front Lights  
#8 Screw Size  
Panel Range: 1/16"-5/32"  
GM 1967-On

UNIT PACKAGE: 50



**13929**  
(10004329, 10009690)  
Natural Nylon

Headlight Spacer Nut  
GM 1979-On

UNIT PACKAGE: 25



**15676**  
(16510893)  
Natural Nylon

Composite Headlight Nut  
#6 Screw Size  
3/8" Sq. Head  
Buick Electra (FWD)  
1987-On

UNIT PACKAGE: 50



**10330**  
(3893980)  
Natural Nylon

Front End & Instrument Panel Nut  
#8 Screw Size  
GM 1967-On

UNIT PACKAGE: 100



**18507**  
(15622475)  
Nylon

Grille/Parking Light  
Spacer Nut  
GM Trucks  
C & K, 1, 2, 3  
1990-On

UNIT PACKAGE: 10



**9829**  
(380382)  
Natural Nylon

Headlight Bezel To Body Nut  
#6 or #8 Screw Size  
GM

UNIT PACKAGE: 50



**11691**  
(3919773)  
Natural Nylon

Headlight Bezel Nut  
#8 Screw Size  
GM 1974-On

UNIT PACKAGE: 100



**14002**  
(16503329)  
Black Nylon

#6 Screw Size  
3/8" Sq. Head  
Fits 1/4" Sq. Hole  
GM

UNIT PACKAGE: 100



**11424**  
(3985058)  
Natural Nylon

Truck Grille Nut  
#6 or #8 Screw Size  
GM Trucks 1974-On

UNIT PACKAGE: 25



**11838**  
(1254815)  
Natural Nylon

#6 Screw Size  
Panel Range: .060"-.150"  
GM 1977-On

UNIT PACKAGE: 50

E-mail Your New  
Product Suggestions  
To [mail@auveco.com](mailto:mail@auveco.com)

**Sec. 20****GENERAL MOTORS CLIPS & FASTENERS****14003**  
(22514578)  
Black NylonParking Lamps  
#8 Screw Size  
GM 1982-On

UNIT PACKAGE: 25

**13933**  
Natural NylonGrille Nut  
#8 or #10 Screw Size  
1/2" Head Size

UNIT PACKAGE: 50

**9069**  
(1355003)  
Natural NylonHeadlight Door to Radiator Grille  
Anchor Nut  
#6 or #8 Screw Size  
Buick 1964-On

UNIT PACKAGE: 50

**11855**  
(GM: 9669486;  
Renault: 8934-201-262)  
Natural NylonSide Marker Nut  
GM 1980-On  
Rear License Plate Bracket  
AMC/Renault  
#8 Screw Size

UNIT PACKAGE: 25

**12735**  
(GM: 1370853;  
Chry: 6029501;  
VW: 179-813-883)  
Natural NylonHeadlight Bezel Nut  
#6 Screw Size  
GM, Chrysler & VW 1982-On

UNIT PACKAGE: 50

**14030**  
(GM: 3997391;  
VW: 179-813-881)  
Black NylonTail Light Nut  
#8 Screw Size  
GM Astro & Safari  
1985-On  
Volkswagen

UNIT PACKAGE: 25

**13960**  
(14013246)  
Natural NylonHeadlight Bezel Nut  
Fits Into 5/16" Hole  
#8 Screw Size  
GM 1967-On

UNIT PACKAGE: 50

**20584**  
(25647358)  
Natural NylonDoor Reveal Moulding  
Screw Grommet  
M4.2 (#8) Screw Size  
Cadillac DeVille and Seville  
1998 - On

UNIT PACKAGE: 25

**10827**  
(411847)  
Natural NylonHeadlight Door Nut  
Oldsmobile 1976-72

UNIT PACKAGE: 25

**14031**  
(12337852,  
15596279,  
21035018)  
Black NylonGrille Retainer & Cowl Vent Nut  
#8 or #10 Screw Size  
Astro, Safari & Saturn 1985-On

UNIT PACKAGE: 25

**13827**  
(GM: 10027915)  
Natural NylonSpeaker Grommet  
Pontiac Fiero

UNIT PACKAGE: 50

**11839**  
(3072505)  
Natural NylonArm Rest Anchor  
#12 or #14 Screw Size  
GM 1978-On

UNIT PACKAGE: 25

**14014**  
(GM: 20475950,  
20624923;  
VW: 175-853-674)  
Black NylonAir Vent Nut  
Use w/14013  
GM & VW

UNIT PACKAGE: 50

**14145**  
(16503548)  
Nylon &  
Stainless SteelHeadlight Glass nut  
GM 1983-On

UNIT PACKAGE: 25

**Remember...**  
**All Items In**  
**This Catalog**  
**Are Available In Bulk.**  
**Call For A Quote**

# GENERAL MOTORS CLIPS & FASTENERS **Sec. 20**



**17271**  
(94113207)  
Natural Nylon

Cowl Cover Retaining Clip  
Head Diameter: 23mm  
Chev. Spectrum  
1989-85

UNIT PACKAGE: 15



**19247**  
(10262143)  
Black Nylon

Air Intake Grille  
Panel Grommet  
For 5mm Stud  
Buick Regal & Century  
Chevrolet Lumina & Monte Carlo  
Oldsmobile Cutlass  
Pontiac Grand Prix  
1996-On

UNIT PACKAGE: 25



**15992**  
(22529957)  
Natural Nylon

Front Bumper Fascia Nut  
Head Dia: 25mm (1")  
Use with 4.2mm (#8) Screw  
Oldsmobile Cutlass Ciera 1985-On

UNIT PACKAGE: 50



**19542**  
(25632157)  
Black Nylon

Headlight/Side Marker Light  
Grommet  
Fits Into 12mm Hole  
Pontiac Bonneville  
1996 - On

UNIT PACKAGE: 15



**11836**  
(559547)  
Natural Nylon

Screw Grommet  
#14 Screw Size  
GM 1960-On

UNIT PACKAGE: 25



**19194**  
(Toyota: 90189-06028;  
GM: 94854203)  
Black Nylon

Front & Rear Wheel  
Fender Liner Screw Grommet  
#12 Screw Size  
Head Diameter: 16mm  
Stem Length: 19mm  
Fits Into 9mm x 9mm Sq. Hole  
Tacoma, T100 &  
4 Runner  
1992 - On  
Chevrolet Nova & Prizm  
And Pontiac Vibe  
1985 - On

UNIT PACKAGE: 15



**19676**  
(10277480)  
Natural Nylon

License Plate Cover  
Screw Grommet  
M4.2 (#8) Screw Size  
Head Diameter: 9/16"  
Stem Length: 9/16"  
Fits Into 1/4" Square Hole  
Oldsmobile Intrigue  
1998 - On

UNIT PACKAGE: 15



**17230**  
(10027015)  
Natural Nylon

Screw Grommet For  
Engine Control Module  
Overall Length: 1-3/16"  
GM (All Divisions)  
1977-On

UNIT PACKAGE: 10



**19429**  
(15954398)  
Rubber

Tail Light Screw Grommet  
Venture, Silhouette,  
Transport, S & T Trucks  
1995-On

UNIT PACKAGE: 25



**11865**  
(GM: 1255823;  
Ford: 389360S)  
Natural Nylon

Front End Bezel Nut  
#6 or #8 Screw Size  
GM 1979-On  
Tail Light Nut  
Ford 1981-On

UNIT PACKAGE: 50

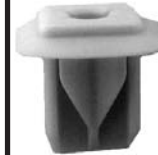

**20452**  
(11517873)  
Natural Nylon

Screw Grommet  
Use With #12 Screw  
Head Size: 5/8" x 3/4"  
Stem Length: 9/16"  
Door Handle  
Chevrolet Impala &  
Monte Carlo  
2000 - On

UNIT PACKAGE: 15

**Sec. 20****GENERAL MOTORS CLIPS & FASTENERS****14037**(GM: 15596280;  
Chry: 6035274)  
Black NylonCowl Vent Nut  
#6 or #8 Screw Size  
GM Astro & Safari 1985-On

UNIT PACKAGE: 25

**10727**(3986978)  
Natural NylonHeadlight Bezel Nut  
#6 Screw Size  
Chevrolet

UNIT PACKAGE: 25

**12713**(GM: 10032838,  
1264963;  
Chry: 6031869;  
AMC: 8934-201-602)  
Natural NylonHigh Torque Screw Grommet  
#6 Screw Size  
GM, Chrysler & AMC-Renault  
1978-On

UNIT PACKAGE: 25

**10365**(1377030)  
Natural NylonValance Panel to Rear  
Bumper Bar Grommet  
#6 or #8 Screw Size  
GM 1971-On

UNIT PACKAGE: 100

**19523**(10271562)  
Natural NylonLiftgate Scuff Plate Grommet  
Fits Into 9/32" x 13/16" Hole  
Chevrolet Venture, Oldsmobile  
Silhouette and Pontiac Trans Sport  
1997 - On

UNIT PACKAGE: 25

**19435**(25526447)  
Natural NylonRadiator Screw  
Grommet  
#6 Screw Size  
Buick Century  
1996 - 86

UNIT PACKAGE: 50

**14009**(14032291)  
Natural NylonGrille Attachment Grommet  
#6 or #8 Screw Size

UNIT PACKAGE: 50

**10369**(1231490)  
White NylonInstrument Panel Grommet  
GM 1974-On

UNIT PACKAGE: 25

**14220**(25525798,  
22537749)  
Natural NylonGrille Retaining Grommet  
#8 Screw Size  
GM 1985-On

UNIT PACKAGE: 50

**20466**(GM: 25649667;  
Ford:  
W705590-S300)  
Natural NylonScrew Grommet  
With Sealer  
M4.2 (#8) Screw Size  
Head Size: 13mm x 22mm  
Stem Length: 18mm  
Back Glass Moulding  
& Interior Trim  
Cadillac & Ford Windstar  
1998 - On

UNIT PACKAGE: 15

**12566**(GM: 25508532;  
Chry: 6032061)  
Black NylonGrille Attaching Grommet  
#6 or #8 Screw Size  
GM & Chrysler 1981-On

UNIT PACKAGE: 25

**19733**(22603044)  
Black NylonFront Bumper  
Fascia Grommet  
Assembles With  
Auveco 19732  
Hinged Pin Retainer  
Pontiac Grand Am  
1999 - On

UNIT PACKAGE: 15

**19732**(22615352)  
Black NylonFront Bumper Fascia  
Hinged Pin Retainer  
Assembles With  
Auveco 19733 Grommet  
Pontiac Grand Am  
1999 - On

UNIT PACKAGE: 15

# GENERAL MOTORS CLIPS & FASTENERS **Sec. 20**



**20635**

(GM: 22722860)  
White Nylon

Trim Panel Grommet  
With Sealer

Flange Diameter: 24mm  
Stem Length: 12mm  
Fits Into 9mm Hole

**Use With Auveco 20634**

Oldsmobile Alero &  
Pontiac Grand Am  
2002 - On

UNIT PACKAGE: 25



**19613**

(15733971)  
Black Nylon

Front Air Deflector Retainer

Small Head Dia.: 18mm  
Medium Head Dia.: 26mm  
Flange Dia.: 30mm  
Stem Length: 24mm

**Use With 19614**

C & K Trucks  
1999 - On

UNIT PACKAGE: 15

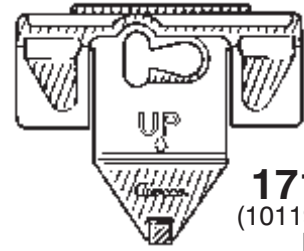

**17128**

(10119853)  
Nylon

Body Side & End Gate Lower  
Moulding Clip

Olds Custom Cruiser  
1991-On

UNIT PACKAGE: 25



**20527**

(15745990)  
Black Nylon

Rear Light Housing  
Lower Grommet

Head Size: 24mm x 24mm  
Stem Length: 17mm  
Fits Into 15mm Hole

GM Bravada, Envoy  
& Trailblazer  
2002 - On

UNIT PACKAGE: 15



**19614**

(15733970)  
Black Nylon

Front Air Deflector  
Grommet

Head Dia.: 28mm  
Stem Length: 13mm

**Use With 19613**

C & K Trucks  
1999-On

UNIT PACKAGE: 25

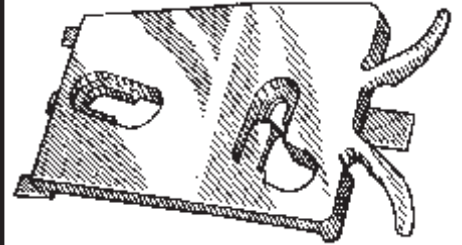

**13925**

(20338568)  
Nylon

Outer Panel Front of Rear  
Wheel Opening Moulding Clip

GM 1982-On

UNIT PACKAGE: 10



**20529**

(15745991)  
Black Nylon

Rear Light Housing  
Upper Grommet

Head Size: 13mm x 20mm  
Stem Length: 17mm  
Fits Into 9mm x 16mm Hole

GM Bravada, Envoy  
& Trailblazer  
2002 - On

UNIT PACKAGE: 15

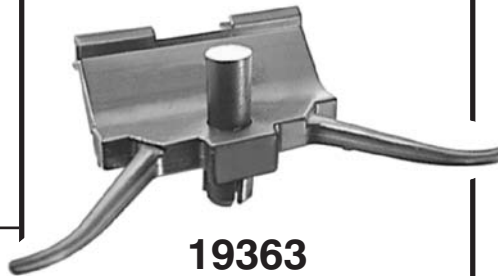

**19363**

(3548693)  
Nylon

Front Door  
Lower Moulding Clip  
Cadillac Eldorado  
1992-On

UNIT PACKAGE: 10



**18911**

(22578985)  
Nylon

Rocker Panel  
Moulding Clip  
Buick Skylark 1993-On

UNIT PACKAGE: 10



**18977**

(15690729)  
Black Nylon

Front & Rear Rocker Panel  
Moulding Retainer  
GM Astro & Safari 1995 - On

UNIT PACKAGE: 25

**Sec. 20**

**GENERAL MOTORS CLIPS & FASTENERS**

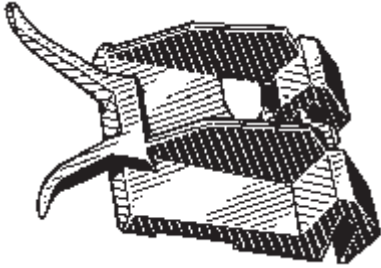

**17545**  
(22550254)  
Nylon

Rocker Panel Moulding Clip  
Pontiac Grand Am SE  
1992-On

UNIT PACKAGE: 25



**13924**  
(10013153)  
Nylon

Rocker Panel Moulding to Fender  
Clip  
GM 1981-On

UNIT PACKAGE: 10



**19361**  
(25554845)  
Nylon

Rocker Panel Moulding Clip  
Pontiac Bonneville  
1992-On

UNIT PACKAGE: 20



**19410**  
(10261327)  
Nylon

Front & Rear Door  
Lower Moulding Clip  
Buick Century, Regal & Rendezvous  
And Pontiac Aztek & Grand Prix  
1997-On

UNIT PACKAGE: 15



**11138**  
(6263345)  
Nylon

Body Side Moulding Clip  
Use w/ 1/8" Pop Rivet  
GM Trucks 1968-On

UNIT PACKAGE: 10

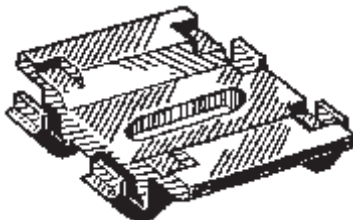

**17548**  
(25604615)  
Nylon

Door Moulding Clip  
Attaches Bright Moulding  
To Trim Panel On Front  
And Rear Doors  
Buick Park Ave.  
1991-On

UNIT PACKAGE: 25



**11481**  
(1731225)  
Nylon

Roof Transverse Moulding Clip  
GM 1976-On

UNIT PACKAGE: 25



**11485**  
(1729250)  
Nylon

Roof Transverse Moulding Clip  
GM 1976-On

UNIT PACKAGE: 25

Visit The Auveco  
Web Site At

[www.auveco.com](http://www.auveco.com)

For The Latest  
Information On New  
Items.

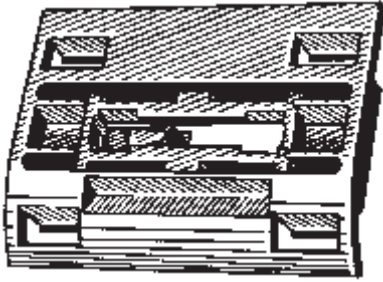

**14215**  
(15597271)  
Nylon

Body Side Moulding Clip  
GM Vans 1985-On

UNIT PACKAGE: 25

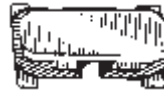

**11816**  
(20046150)  
Nylon

Quarter Belt Moulding Clip  
GM 1977-On

UNIT PACKAGE: 50



**14946**  
(20606417)  
Nylon

Left Outer Panel In Front of Rear  
Wheel Opening Moulding Clip  
1-3/16" Long, 7/8" Wide  
Pontiac Bonneville 1989-87

UNIT PACKAGE: 25



**14945**  
(20606416)  
Nylon

Right Outer Panel In Front of Rear  
Wheel Opening Moulding Clip  
1-3/16" Long; 7/8" Wide  
Pontiac Bonneville 1989-87

UNIT PACKAGE: 25



**10220**  
(4457595,  
4457495)  
Nylon

Quarter Belt & Wheel Opening  
Moulding Clip  
GM 1967 -On

UNIT PACKAGE: 50

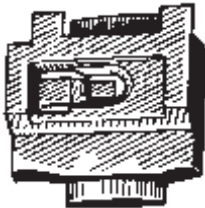

**14222**  
(20467623)  
Nylon

Roof Panel Moulding Clip  
GM

UNIT PACKAGE: 25



**11802**  
(20067021)  
Nylon

Belt Moulding Clip  
GM 1977-On

UNIT PACKAGE: 50

Inquire About Our  
FasTrack Cost  
Recovery Program  
For Body Shops



**11288**  
(9838109)  
Gray Nylon

Body Side Moulding Clip  
Buick, Chevrolet & Oldsmobile  
1967-On

UNIT PACKAGE: 100



**18118**  
(10135796)  
Nylon

Body Side Moulding Clip  
Buick Roadmaster  
1991-On

UNIT PACKAGE: 15



**9850**  
(7731589)  
Blue Nylon

Quarter Panel Reveal Moulding &  
Landau Top Moulding Clip  
Use With Screw 9877  
GM

UNIT PACKAGE: 100



**12602**  
(20237057)  
Nylon

Moulding Clip  
GM 1980-On

UNIT PACKAGE: 25



**11425**  
(1688094)  
Nylon

Vinyl Top Clip  
(Used on narrow Moulding across  
top of roof)  
Chevrolet, Cadillac & Oldsmobile  
1974-On

UNIT PACKAGE: 50



**10617**  
(8799350)  
Nylon

Door, Quarter Panel & Rear End  
Moulding Clip  
GM 1970-On

UNIT PACKAGE: 50



**12621**  
(14022878)  
Nylon

Moulding Clip  
GM 1980-On

UNIT PACKAGE: 25



**12613**  
(20315425)  
Nylon

Moulding Clip  
GM 1981-On

UNIT PACKAGE: 50



**11426**  
(9727078)  
Nylon

Belt Moulding Clip  
GM

UNIT PACKAGE: 50



**12563**  
(20175051,  
15633873)  
Nylon

Quarter Belt Reveal Moulding Clip  
GM 1980-On

UNIT PACKAGE: 50



**18210**  
(25500454)  
Nylon

Rocker Panel  
Moulding Clip  
Buick 1981-On

UNIT PACKAGE: 25

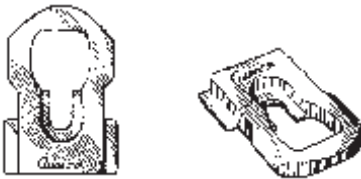

**11717**  
(1660123)  
Nylon

Belt Moulding Clip  
GM 1975-On

UNIT PACKAGE: 50



**12594**  
(20171942)  
Nylon

Moulding Clip  
GM 1980-On

UNIT PACKAGE: 25



**14642**  
(20199675)  
Nylon

Quarter Belt Reveal Moulding Clip  
7/16" Wide, 31/32" long  
GM 1980-On

UNIT PACKAGE: 50



# GENERAL MOTORS CLIPS & FASTENERS **Sec. 20**



**12828**  
(22512114)  
Nylon

Rocker Panel Moulding Clip  
GM 1982-On

UNIT PACKAGE: 50

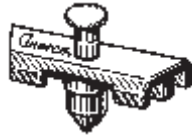

**17219**  
(21093588)  
Nylon

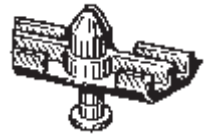

Roof Drip Moulding Clip  
2 Door & 4 Door Models  
GM Saturn 1991-On

UNIT PACKAGE: 25



**12824**  
(20274997)  
Nylon

Rear Quarter Reveal Moulding Clip  
GM 1980-On

UNIT PACKAGE: 50



**10318**  
(8733059  
4492962, 9838109)  
Nylon

Body Side & Wheel Opening Moulding Clip  
Buick, Chevrolet & Oldsmobile 1968-On

UNIT PACKAGE: 100



**14033**  
(20393536)  
Nylon

Front/Side Fender Moulding Clip  
GM Truck 1983-On

UNIT PACKAGE: 25



**20263**  
(22599312)  
Black Nylon

Front & Rear Door  
Window Moulding Clip  
Chevrolet Malibu, Oldsmobile  
Achieva & Cutlass  
1997 - On

UNIT PACKAGE: 25

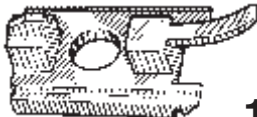

**13458**  
(20444103)  
Nylon

Door Moulding Clip  
GM 1984-On

UNIT PACKAGE: 15



**20232**  
(10287926)  
Yellow Nylon

Front & Rear Door  
Window Moulding Clip  
Overall Length: 1-9/16"  
Buick Century & Regal  
and Oldsmobile Intrigue  
1997 - On

UNIT PACKAGE: 25



**13828**  
(GM: 1706200)

Quarter Belt Moulding Clip  
Cadillac 1976-On

UNIT PACKAGE: 25

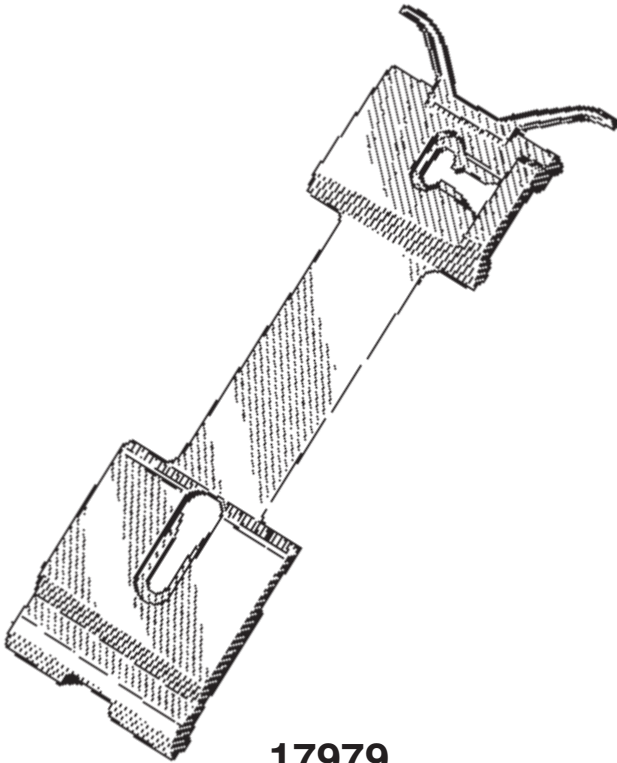

**17979**  
(25552856)  
Nylon

Front & Rear Door Center Moulding Clip  
4-3/8" Long  
Buick LeSabre Ltd. 1992-On

UNIT PACKAGE: 5

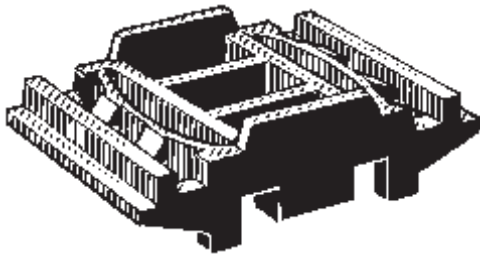

**18417**  
(12519975)  
Nylon

Front & Rear Door  
Lower Finish Panel  
(Lower) Moulding Clip  
**Use With 18421**  
Pontiac Bonneville  
1992-On

UNIT PACKAGE: 15

“You can’t find a place to save a million dollars. But there are a million places to save a dollar.”

“Pop” Gale



**20578**

(GM: 88970495,  
Toyota: 76924-52021)  
Black Nylon

Rocker Moulding Retainer  
Head Diameter: 32mm  
Stem Length: 10mm  
Fits Into 22mm Hole  
Pontiac Vibe & Toyota Corolla  
2003 - On

UNIT PACKAGE: 25



**18421**

(25606388)  
Nylon

Front & Rear Door  
Lower Finish Panel Moulding Clip

**Use With 18417**  
Pontiac Bonneville  
1992-On

UNIT PACKAGE: 25

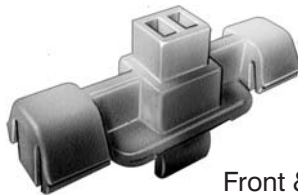

**19358**

(3526573)  
Nylon

Front & Rear Door  
Lower Moulding Clip  
Cadillac DeVille & Seville  
1997-92

UNIT PACKAGE: 10



**18418**

(16611889)  
Nylon

Front Fender, Door  
& Rear Quarter Panel  
Center Moulding (Lower) Clip  
Pontiac Grand Prix  
1991-On

UNIT PACKAGE: 10



**18429**

(12519972)  
Nylon

Rear Door  
Lower Finish Panel  
Upper Moulding Clip  
Pontiac Bonneville  
1992-On

UNIT PACKAGE: 15

# GENERAL MOTORS CLIPS & FASTENERS **Sec. 20**

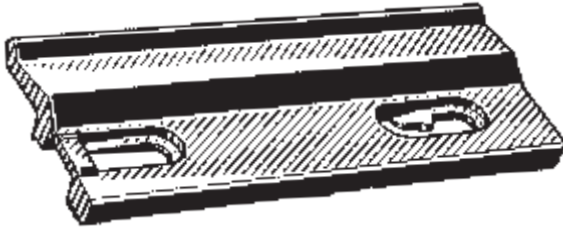

**18425**  
(10167456,  
10220975)  
Nylon

Front & Rear Door  
Moulding Clip  
Olds Cutlass Supreme, Royale  
1992-On

UNIT PACKAGE: 15

Not Actual Size



**19389**  
(25630330)  
Nylon

Front Fender and  
Front & Rear Door  
Upper Moulding Clip  
Pontiac Bonneville  
1996-On

UNIT PACKAGE: 10

Not Actual Size

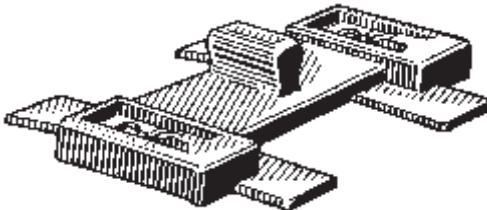

**18427**  
(20730529)  
Nylon

Front & Rear Door  
Lower Finish Panel  
Moulding Clip  
Cadillac Seville, Olds 98  
& Pontiac Bonneville  
1988-On

UNIT PACKAGE: 15

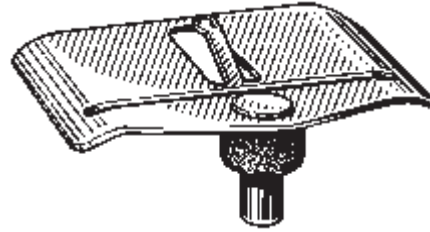

**18430**  
(20448469)  
Phosphate

Front & Rear Door  
Rocker Panel  
Moulding Clip  
Buick Somerset Regal & Skylark  
1991-85

UNIT PACKAGE: 10

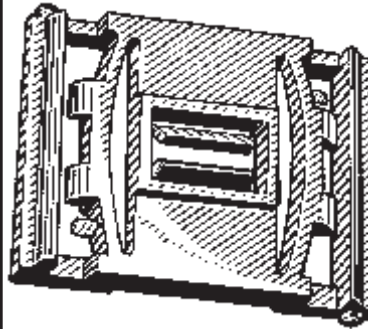

**18511**  
(12506127)  
Nylon

Front & Rear Door  
Lower Moulding Clip  
Buick Electra Park Ave.,  
Cadillac Seville, Olds  
Delta 88 Royale &  
Pontiac Bonneville  
1991-On

UNIT PACKAGE: 15



**19411**  
(25630331)  
Nylon

Front Door And  
Front & Rear Fender  
Moulding Clip  
Pontiac Bonneville  
1996-On

UNIT PACKAGE: 10



**18428**  
(10167448)  
Nylon

Rear Quarter Center Front  
Moulding Clip  
Olds Cutlass  
(Exc. Deluxe Extra Trim)  
1994-92

UNIT PACKAGE: 25

**Sec. 20**

**GENERAL MOTORS CLIPS & FASTENERS**

Not Actual Size

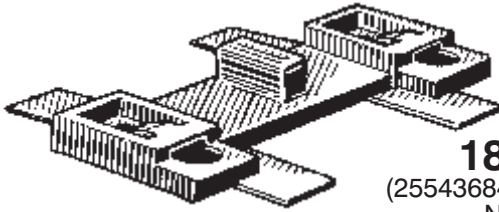

**18459**  
(25543684, 25600989)  
Nylon

Door Lower Finish  
Panel Moulding Clip  
Buick Park Ave., Cadillac Seville, Olds 88 Royale &  
Pontiac Bonneville 1991-On

UNIT PACKAGE: 25

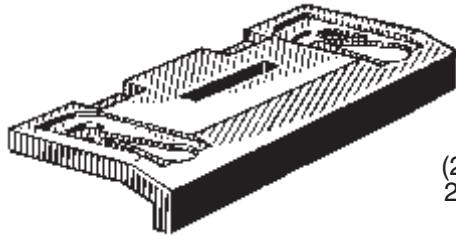

**18422**  
(25552852,  
25633289)  
Nylon

Door Upper Moulding Clip  
w/Deluxe Extra Trim  
Pontiac Bonneville 1992-On

UNIT PACKAGE: 15

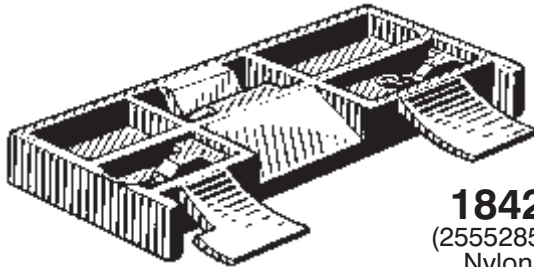

**18423**  
(25552853)  
Nylon

Door Upper Moulding Clip  
Pontiac Bonneville 1992-On

UNIT PACKAGE: 15

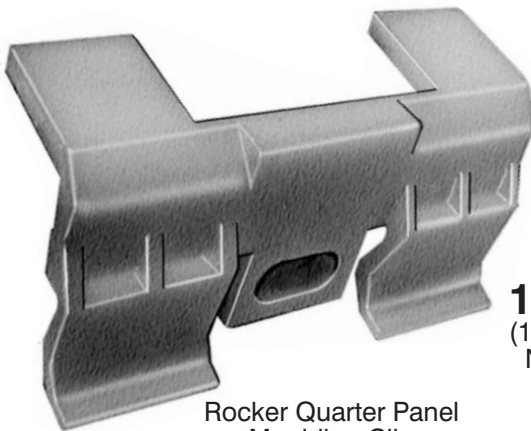

**19357**  
(10167445)  
Nylon

Rocker Quarter Panel  
Moulding Clip  
Oldsmobile Cutlass  
Supreme  
1997-92

UNIT PACKAGE: 15



**19370**  
(16615006)  
Nylon

Rocker Panel Moulding Clip  
Oldsmobile Aurora  
1995-On

UNIT PACKAGE: 15

Not Actual Size



**19360**  
(22637865)  
Nylon

Rocker Panel Moulding Clip  
Pontiac Grand Am  
1996-On

UNIT PACKAGE: 10

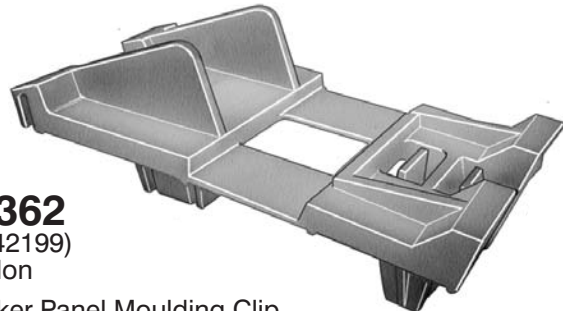

**19362**  
(22642199)  
Nylon

Rocker Panel Moulding Clip  
Oldsmobile Achieva & Cutlass  
1997-On

UNIT PACKAGE: 25

**19412**  
(25630332)  
Nylon

Rocker Panel  
Moulding Clip  
Pontiac Bonneville  
1996-On

UNIT PACKAGE: 10

# GENERAL MOTORS CLIPS & FASTENERS **Sec. 20**

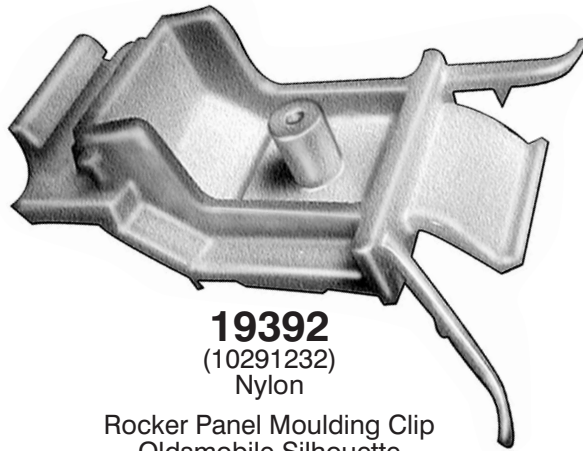

**19392**

(10291232)  
Nylon

Rocker Panel Moulding Clip  
Oldsmobile Silhouette  
1997-On

UNIT PACKAGE: 10

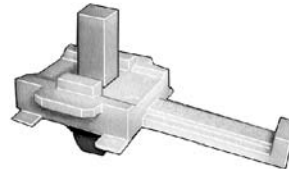

**19390**

(10270672)  
Nylon

Rear Side Door  
Lower Moulding Clip  
Pontiac Trans Sport, Montana  
1997-On

UNIT PACKAGE: 10



**20353**

(10442914)  
White Nylon

Rocker Panel Moulding Clip  
Top Head Size: 1/2" x 9/16"  
Bottom Head Size: 9/16" x 5/8"  
Stem Length: 9/16"  
Fits Into 7/16" Hole  
Buick Rendezvous  
2002 - On

UNIT PACKAGE: 15

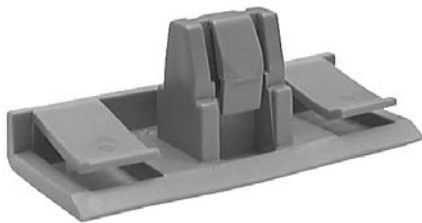

**20280**

(25648693)  
Gray Nylon

Rocker Panel  
Moulding Clip  
7/8" Wide  
2" Long  
Cadillac DeVille  
& Seville  
1998 - On

UNIT PACKAGE: 10



**20481**

(10423553)  
Green Nylon

Side Moulding, Fender &  
Rocker Panel Moulding Clip  
Top Head Size: 1/2" x 13/16"  
Bottom Head Size: 19/32" x 13/16"  
Stem Length: 9/16"  
Fits Into 7/16" Hole  
Pontiac Aztek And  
GM C & K Trucks  
2001 - On

UNIT PACKAGE: 15

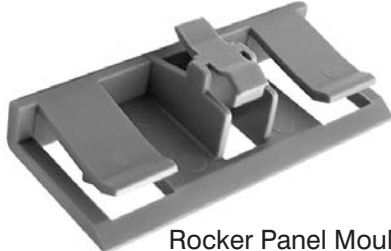

**20522**

(25691949, 25704001)  
Black Nylon

Rocker Panel Moulding Clip  
Width: 7/8", Length: 2"  
Buick Park Ave., Cadillac DeVille & Seville  
And Pontiac Bonneville  
2000 - On

UNIT PACKAGE: 10



**20521**

(10242285, 10308019, 10297369)  
Black Nylon With Sealer

Rocker Panel Moulding Clip  
Top Head Size: 15/32" x 25/32"  
Bottom Head Size: 5/8" x 25/32"  
Stem Length: 9/16"  
Fits Into 7/16"  
Pontiac Aztek, Montana & Trans Sport  
1997 - On

UNIT PACKAGE: 15

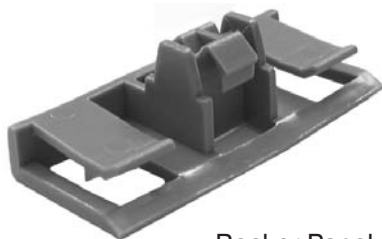

**20318**

(25722671)  
Gray Nylon

Rocker Panel Clip  
Width: 7/8"  
Length: 2"  
Buick LeSabre, Cadillac DeVille &  
Seville, Oldsmobile Aurora and  
Pontiac Bonneville  
2000 - On

UNIT PACKAGE: 10



**18274**  
(16614134)  
Nylon

Front Fender &  
Door Moulding Clip  
Olds Cutlass Supreme  
4 Door  
1992-On

UNIT PACKAGE: 25



**20617**  
(10242602)  
Green Nylon

Wheel Opening  
Moulding Clip  
Top Head Size: 9/16" x 13/16"  
Bottom Head Size: 9/16" x 13/16"  
Stem Length: 1/2"  
Fits Into 7/16" Hole  
Pontiac Trans Sport/Montana  
1997 - On

UNIT PACKAGE: 10



**19379**  
(10297371)  
Yellow Nylon

Rear Wheel Opening  
Moulding Clip  
Top Head Size: 19/32" x 25/32"  
Bottom Head Size: 19/32" x 25/32"  
Stem Length: 9/16"  
Fits Into 7/16" Hole  
Pontiac Trans Sport, Montana  
With Long Wheel Base  
1997-On

UNIT PACKAGE: 15



**19381**  
(10297368)  
White Nylon

Rear Wheel Opening  
Moulding Clip  
Top Head Size: 15/32" x 25/32"  
Bottom Head Size: 1/2" x 25/32"  
Stem Length: 9/16"  
Fits Into 7/16" Hole  
Pontiac Trans Sport, Montana  
With Short Wheel Base  
1997-On

UNIT PACKAGE: 10



**18390**  
(10082288)  
Black Nylon

Front Door  
Moulding Retainer  
Chevrolet Beretta, Corsica  
1987-On

UNIT PACKAGE: 25



**18419**  
(16611887)  
Nylon

Front Fender, Door  
& Rear Quarter Panel  
Center Moulding (Upper) Clip  
Pontiac Grand Prix  
1991-On

UNIT PACKAGE: 15



**20408**  
(10287547)  
White Nylon

Door & Rocker Panel  
Moulding Clip  
Top Head Size: 3.5mm x 8mm  
Bottom Head Size: 8.7mm x 12mm  
Stem Length: 8mm  
Fits Into 8mm Hole  
Buick Century, Regal &  
Pontiac Grand Prix  
1995 - On

UNIT PACKAGE: 25



**19757**  
(10431524)  
Black Nylon

Rocker Panel  
Moulding Clip  
Head Size: 11/16" x 1-5/16"  
Stem Length: 9/16"  
Snaps Into 5/16" Hole  
Chevrolet Impala, Lumina  
& Monte Carlo  
2000 - On

UNIT PACKAGE: 15



**18420**  
(16611888)  
Nylon

Front Fender, Door  
& Rear Quarter Panel  
Center Moulding (Lower) Clip  
Pontiac Grand Prix  
1991-On

UNIT PACKAGE: 15



**15695**  
(Toyota:  
62955-20020;  
GM: 94848834)  
Nylon

Retainer With Sealer  
Head Dia: 15mm  
Stem Length: 9mm  
Fits Into 8mm Hole  
Toyota Pick-Up Truck  
Pontiac Vibe

UNIT PACKAGE: 25



**20326**  
(25718851)  
Yellow Nylon

Door Trim Moulding Clip  
Head Size: 9/16" x 3/4"  
Stem Length: 3/8"  
Cadillac DeVille & Seville  
1998 - On

UNIT PACKAGE: 25

# GENERAL MOTORS CLIPS & FASTENERS **Sec. 20**



**19800**  
(10437565)  
Black Nylon

Rocker Panel  
Moulding Clip  
Head Size: 15/32" x 1-5/16"  
Stem Length: 9/16"  
Snaps Into 5/16" Hole  
Chevrolet Impala,  
Lumina & Monte Carlo  
2000 - On

UNIT PACKAGE: 10



**20417**  
(91176726)  
White Nylon

Side Door, Wheel Opening  
& Rocker Panel  
Moulding Clip With Sealer  
Top Head Size: 15/32" x 25/32"  
Bottom Head Size: 9/16" x 25/32"  
Stem Length: 7/16"  
Fits Into 7/16" Hole  
Geo Tracker 2001 - On

UNIT PACKAGE: 15



**18833**  
(3531990)  
Nylon

Rocker Panel  
Push-Type  
Moulding Clip  
Cadillac Seville &  
Touring Sedan  
1994-On

UNIT PACKAGE: 5



**20520**  
(10308063)  
Black Nylon

Rocker Panel Moulding Clip  
Head Size: 18mm x 35mm  
Stem Length: 20mm  
Fits Into 10mm Hole  
Buick Rendezvous &  
Pontiac Aztek  
2001 - On

UNIT PACKAGE: 15



**20328**  
(10443956)  
White Nylon

Rocker Panel  
Moulding Clip  
Top Head Size: 9/16" x 13/16"  
Bottom Head Size: 13/16" x 13/16"  
Stem Length: 9/16"  
Fits Into 7/16" Hole  
Chevrolet Impala, Lumina,  
Monte Carlo and C & K Trucks  
2000 - On

UNIT PACKAGE: 15



**19008**  
(16616138)  
Black Nylon

Rocker Panel Moulding Clip  
Cavalier & Sunfire  
1995-On

UNIT PACKAGE: 25



**20607**  
(10323057)  
White Nylon

Rocker Moulding Clip  
Top Head Size: 12mm x 20mm  
Stem Length: 14mm  
Fits Into 9mm Hole  
Pontiac Grand Prix  
2004 - On

UNIT PACKAGE: 15



**18831**  
(10229345)  
Nylon

Front Fender Lower  
Moulding Clip  
Pontiac Grand Prix With  
Sport Performance Pkg.  
1994-On

UNIT PACKAGE: 5



**19820**  
(22603384)  
White Nylon

Rocker Panel Moulding Clip  
Head Size: 3/4" x 1-3/16"  
Stem Length: 19/32"  
Fits Into 7/16" Hole  
Oldsmobile Alero  
& Pontiac Grand Am  
1999 - On

UNIT PACKAGE: 15



**20377**  
(11518357)  
White Nylon

Rocker Panel Moulding Clip  
Top Head Size: 9/16" x 13/16"  
Bottom Head Size: 13/16" x 13/16"  
Stem Length: 9/16"  
Fits Into 7/16" Hole  
Chevrolet Avalanche  
2002 - On

UNIT PACKAGE: 15



**19822**  
(25693852)  
Gray Nylon

Rocker Panel Moulding Clip  
Top Head: 9/16" x 3/4"  
Bottom Head: 5/8" x 3/4"  
Stem Length: 9/16"  
Fits Into 7/16" Hole  
Buick LeSabre; Cadillac Concours,  
DeVille, Eldorado & Seville;  
Chevrolet Impala, Lumina & Monte  
Carlo; Oldsmobile Aurora and  
Pontiac Bonneville  
1995 - On

UNIT PACKAGE: 25

**Sec. 20**

**GENERAL MOTORS CLIPS & FASTENERS**

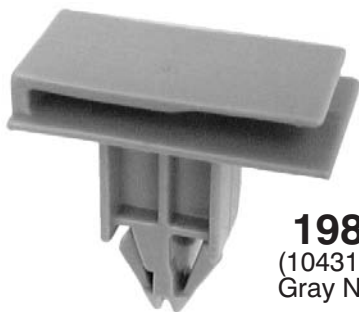

**19821**  
(10431761)  
Gray Nylon

Rocker Panel Moulding Clip  
Top Head Size: 11/16" x 1-1/2"  
Bottom Head Size: 7/8 x 1-9/16"  
Stem Length: 1-1/4"  
Fits Into 7/16" Hole  
Chevrolet Impala,  
Lumina & Monte Carlo  
2000 - On

UNIT PACKAGE: 15



**18398**  
(20058837)  
Nylon

Windshield Upper Garnish  
Moulding Clip  
GM A & G Models  
1988-78

UNIT PACKAGE: 10

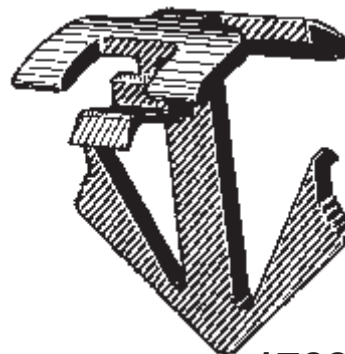

**17666**  
(20632190)  
Nylon

Garnish Moulding Clip  
Back Window Upper &  
Side Moulding Garnish  
Buick LeSabre, Cadillac Fleetwood  
Brougham, Chevrolet Caprice &  
Impala, Olds Delta 88 & 98,  
Pontiac Bonneville & Parisienne  
1989-80

UNIT PACKAGE: 10



**20464**  
(10270517)  
White Nylon

Rocker Panel &  
Fender Flare  
Moulding Clip  
Overall Length: 41mm  
Stem Length: 13mm  
Fits Into 12mm Hole  
Pontiac Trans Sport &  
Montana  
1997 - On

UNIT PACKAGE: 5

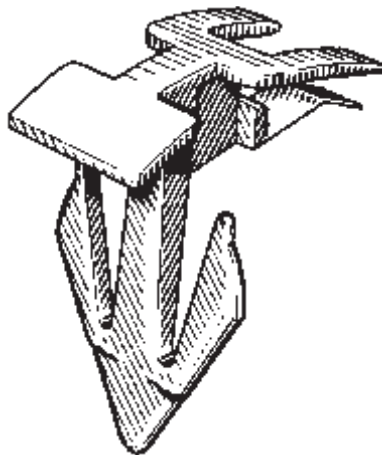

**17074**  
(20007308)  
Nylon

Windshield & Back  
Window  
Garnish Clip  
Buick Electra & LeSabre;  
Cadillac DeVille & Fleetwood;  
Chevrolet Caprice & Impala;  
Oldsmobile 88 & 98 and  
Pontiac Bonneville 1984-77

UNIT PACKAGE: 25

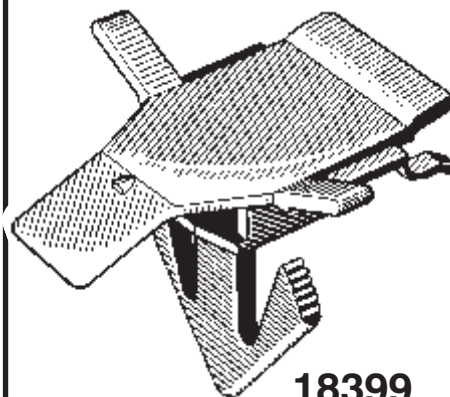

**18399**  
(20095324)  
Nylon

Back Window Upper Garnish  
Moulding Clip  
GM (Except Cadillac) 1988-78

UNIT PACKAGE: 10

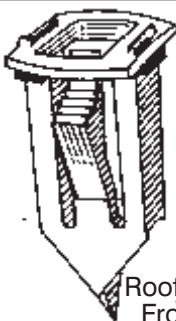

**11118**  
(9617200)  
Nylon

Roof, Inner Side  
Front, Rear &  
Panel  
Headlining Clip  
GM 1973-On

UNIT PACKAGE: 10

**11119**

Same as 11118 except packing

UNIT PACKAGE: 100



**16865**  
(20462090)  
Nylon

Garnish Moulding Clip  
Buick Century & Regal, Chevrolet  
Camaro, Celebrity, Monte Carlo &  
Malibu, Oldsmobile Cutlass & Ciera,  
Pontiac Firebird Grand Prix & 6000  
1978-On

UNIT PACKAGE: 25



# GENERAL MOTORS CLIPS & FASTENERS **Sec. 20**



**9477**  
(4490167)  
Nylon

Tailgate Belt Moulding Fastener  
Chevrolet El Camino

UNIT PACKAGE: 50

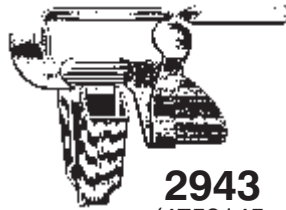

**2943**  
(4759145,  
4761842,  
4779348)

Front and Rear Fender and Door  
Peak Moulding Fastener  
GM

UNIT PACKAGE: 15



**19433**  
(25618359)  
Black Nylon

Front Bumper Fascia  
Push-Type Retainer  
Head Size: 15/32" x 7/8"  
Stem Length: 15/32"  
Fits Into 9/32" Hole  
Buick Park Ave.  
1996-92

UNIT PACKAGE: 25



**17233**  
(9662548)  
Nylon

Headlining Wire Retainer Clip  
Also Panel To Rear Bumper  
Filler Clip  
GM 1990-73

UNIT PACKAGE: 50



**19602**

Chevrolet Grille Bolt Kit  
For: Installing and attaching Grille on  
Chevrolet Cars.

Consists of: 50 pcs. 10-24 x 1/2"  
Machine Screws  
50 pcs. 10-24 Keps Nuts

UNIT PACKAGE: 50 Sets



**14008**  
(14032200)  
Black Nylon

Grille Attachment  
Retainer  
Head Size: 3/4" x 19/32"  
Stem Length: 19/32"  
Fits Into 5/16" Hole  
GM 1981-On

UNIT PACKAGE: 25



**9965**  
(3944866, 1244839)

Universal Moulding Fastener  
GM

UNIT PACKAGE: 25



**14013**  
(GM: 20475949;  
VW: 175-853-673)  
Black Nylon

Air Vent Screw  
Use With 14014

UNIT PACKAGE: 50

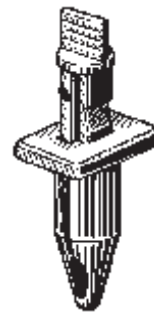

**16719**

(12338150,  
22533245,  
22535311)  
Black Nylon

Radiator Grille Retainer  
Head Size: 11mm x 16mm  
Stem Length: 23mm  
Fits Into 8mm (5/16") Hole  
Chevrolet Cavalier &  
Pontiac Sunbird 1982-On

UNIT PACKAGE: 25

**12971**

Same as 9965 except packing

UNIT PACKAGE: 10



**14727**

(GM: 94221150;  
Nissan: 63844-00100)  
Black Nylon

Push-Type Retainer  
Head Size: 14mm x 22mm  
Stem Length: 9mm  
Fits Into 7mm Hole  
Geo Storm 1990-On

UNIT PACKAGE: 25

**Sec. 20****GENERAL MOTORS CLIPS & FASTENERS****19335**(22659122)  
Black Nylon

Front Bumper Fascia  
Push-Type Retainer  
Head Size: 1-1/8" x 1-3/4"  
Stem Length: 15/16"  
Fits Into 1/2" Hole  
Chevy Malibu, Olds Achieva  
& Cutlass  
1997 - On

UNIT PACKAGE: 10

**14001**(14039420)  
Black Nylon

Push-Type Retainer  
Head Dia: 21/32"  
Stem Length: 19/32"  
Fits Into 5/16" Hole  
GM (Including Saturn)

UNIT PACKAGE: 25

**14697**(GM: 94198687;  
Honda: 90657-SA6-0030;  
Mazda: N304-13-356-A)  
Black Nylon

Push-Type Retainer  
Head Dia: 14mm  
Stem Length: 11mm  
Fits Into 7mm Hole

UNIT PACKAGE: 25

**19726**(94858343)  
Black Nylon

Door Trim Panel  
Push-Type Retainer  
Head Diameter: 14mm  
Stem Length: 8mm  
Fits Into 6mm Hole  
Geo Prizm  
1998-On

UNIT PACKAGE: 15

**19645**(94858864)  
Gray Nylon

Door Trim Panel  
Push-Type Retainer  
Head Diameter: 14mm  
Stem Length: 8mm  
Fits Into 6mm Hole  
Geo Prizm  
1998 - On

UNIT PACKAGE: 15

**14260**(Toyota: 90467-06017;  
Mazda: 9926-50-625;  
GM: 20426301)  
Black Nylon

Push-Type Retainer  
Head Diameter: 15mm  
Stem Length: 12mm  
Fits Into 7mm Hole

UNIT PACKAGE: 15

**19243**(GM: 30008324;  
Suzuki: 09409-07325)  
Black Nylon

Push-Type Retainer  
Head Diameter: 16mm  
Stem Length: 10mm  
(Not Including The Pin)  
Fits Into 9mm Hole  
Front & Rear Bumper Fascia  
Geo Metro 1989-On  
Radiator Grille  
Suzuki Esteem 1995-On

UNIT PACKAGE: 15

**13457**(20451119)  
Black Nylon

Front Compartment  
Spare Tire Retainer  
Head Diameter: 43/64"  
Stem Length: 23/32"  
Fits Into 5/16" Hole  
GM

UNIT PACKAGE: 10

**17149**(94328493)  
Black Nylon

Front Wheel Panel  
Liner Retainer  
Head Diameter: 18mm  
Stem Length: 9mm  
Fits Into 8mm Hole  
Geo Storm 1992-90

UNIT PACKAGE: 10

**20577**(GM: 88970494;  
Toyota:  
90467-07168)  
Black Nylon

Rocker Panel & Garnish Moulding  
Push-Type Retainer  
Head Diameter: 20mm  
Stem Length: 8mm  
Fits Into 7mm Hole  
Pontiac Vibe 2003 - On  
Lexus & Toyota  
2000 - On

UNIT PACKAGE: 15

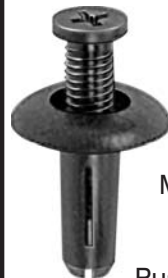
**19140**(Acura:  
90505-SL0-003;  
GM: 94852368;  
Mitsubishi:  
MB888869; Toyota:  
90467-08155)  
Black Nylon

Push-Type Retainer  
Head Diameter: 20mm  
Stem Length: 21mm  
Fits Into 8mm Hole  
Acura, Dodge Avenger,  
Eagle Talon, Geo Prizm  
Mitsubishi Eclipse & Galant  
and Toyota  
1993-On

UNIT PACKAGE: 5

# GENERAL MOTORS CLIPS & FASTENERS **Sec. 20**



**19242**  
(15672149)  
Black Nylon

Air Inlet Grille Panel  
Push-Type Retainer  
Head Dia. 13/32"  
Stem Length: 11/16"  
Fits Into 7/32" Hole  
GM Jimmy, Blazer, S-10  
& Bravada  
1994-On

UNIT PACKAGE: 25



**17214**  
(GM: 21042098;  
Chry: 55075139)  
Black Nylon

Push-Type Retainer  
Head Dia: 11mm  
Stem Length: 18mm  
Fits Into 6mm Hole  
GM Saturn  
4 Door & Station Wagon  
1991-On

UNIT PACKAGE: 25



**14990**  
(22538102)  
Black Nylon

Push-Type Retainer  
Head Diameter: 7/16"  
Stem Length: 15/32"  
Fits Into 15/64" Hole  
GM 1987 - On

UNIT PACKAGE: 50



**14987**  
(10089262)  
Black Nylon

Push-Type Retainer  
Head Diameter: 7/16"  
Stem Length: 11/16"  
Fits Into 15/64" Hole  
GM 1987 - On

UNIT PACKAGE: 50



**19787**  
(22657634)  
Black Nylon

Fender & Rocker Panel  
Push-Type Retainer  
Head Diameter: 12mm  
Stem Length: 17mm  
Fits Into 6mm Hole  
Achieva, Cutlass,  
Grand Am & Malibu  
1999 - On

UNIT PACKAGE: 25



**14995**  
(GM: 10195515,  
Ford: N805026S;  
Chrys: 4696488,  
6503163)  
Black Nylon

Push-Type Retainer  
Head Diameter: 1/2"  
Stem Length: 1-13/64"  
Fits Into 9/32" Hole  
GM, Ford & Chrysler  
1987 - On

UNIT PACKAGE: 25



**19788**  
(10246149; 22657634)  
Black Nylon

Rocker Panel  
Push-Type Retainer  
Head Diameter: 13mm  
Stem Length: 20mm  
Fits Into 6mm Hole  
Achieva, Cutlass,  
Grand Am & Malibu  
1999 - On

UNIT PACKAGE: 25



**16859**  
(Nissan: 66860-01W01;  
GM: 94051993)  
Black Nylon

Cowl Panel To  
Reinforcement Plate & Engine  
Splash Shield Retainer  
Head Dia: 14mm (9/16")  
Stem Length: 16mm (5/8")  
Fits Into 6mm (1/4") Hole  
Nissan 1980-On  
Geo Storm 1990-On

UNIT PACKAGE: 25



**14997**  
(10053182)  
Black Nylon

Push-Type Retainer  
Head Diameter: 19/32"  
Stem Length: 13/16"  
Fits Into 5/16" Hole  
GM 1987 - On

UNIT PACKAGE: 25



**14991**  
(GM: 10139822;  
25680782;  
Ford: N808147S)  
Black Nylon

Push-Type Retainer  
Head Diameter: 11/16"  
Stem Length: 11/16"  
Fits Into 1/4" Hole  
GM & Ford 1987 - On

UNIT PACKAGE: 25



**14753**  
(GM: 20664092;  
Ford: N804570S)  
Black Nylon

Radiator Shroud &  
Trim Retainer  
Head Dia: 11/16"  
Stem Length: 7/8"  
Fits Into 1/4" Hole  
GM 1982-On  
Ford 1986-On

UNIT PACKAGE: 25

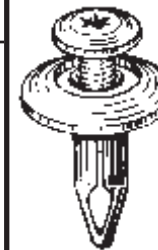

**14993**  
(22538004)  
Black Nylon

Push-Type Retainer  
Head Diameter: 11/16"  
Stem Length: 7/8"  
Fits Into 1/4" Hole  
GM 1987 - On

UNIT PACKAGE: 25

**Sec. 20****GENERAL MOTORS CLIPS & FASTENERS****16835**(GM: 10140480;  
Chry: 6502625)  
Black NylonRear Bumper  
Fascia RetainerHead Dia: 21mm (27/32")  
Shoulder Length: 3mm (1/8")  
Stem Length: 25mm (1")  
Fits Into 12mm (1/2") Hole  
APV Vans 1990-On

UNIT PACKAGE: 25

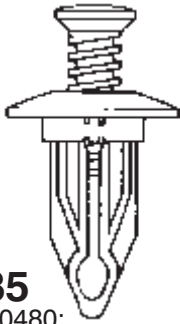
**17227**(21077405)  
Black NylonDoor Handle To Door  
Hardware AttachmentPush-Type Retainer  
Head Diameter: 7mm

Stem Length: 10mm

Fits Into 5mm Hole

2 Door &amp; 4 Door Models

GM Saturn 1991-On

UNIT PACKAGE: 25

**11854**(14005089)  
Natural NylonAir Conditioning Vent & General  
Purpose Push-Type Retainer

Head Diameter: 7/16"

Stem Length: 9/32"

Fits Into 3/16" Hole

GM 1979 - On

UNIT PACKAGE: 25

**19434**(GM: 90319187;  
Mercedes: 000-990-25-92)  
White Nylon

Cowl &amp; Side Lower Moulding

Bumper Fascia

Push-Type Retainer

Head Diameter: 10mm

Stem Length: 12mm

Fits Into 6mm Hole

Cadillac Catera

1997-On

Mercedes E Class

1996 - On

UNIT PACKAGE: 25

**18933**(15676045)  
Black NylonRear Window  
Wiper Motor Cover  
& Dash Board

Push-Type Retainer

Head Diameter: 7/16"

Stem Length: 1/2"

Fits Into 1/4" Hole

GM Trucks C &amp; K, 1, 2

1991 - On

UNIT PACKAGE: 25

**14998**(15672330,  
15956470)  
Black NylonPush-Type Retainer  
Head Diameter: 27/32"

Stem Length: 1"

Fits Into 13/32" Hole

GM 1987 - On

UNIT PACKAGE: 25

**20265**(25663903)  
Black Nylon

Radiator Support Sight Shield

Push-Type Retainer

Head Diameter: 1"

Stem Length: 1"

Fits Into 1/4" Hole

Cadillac DeVille &amp; Seville

1998 - On

UNIT PACKAGE: 10

**17383**(96057847)  
Black Nylon

Radiator Grille

&amp; Trim Panel

Push-Type Retainer

Head Diameter: 11mm

Stem Length: 14mm

Fits Into 7mm Hole

Geo Tracker &amp; Prizm

1992-89

UNIT PACKAGE: 10

**20666**(22677979, 22677980)  
Gray Nylon

Door Trim

Push-Type Retainer

Head Diameter: 12mm

Stem Length: 14mm (Exc. Pin)

Fits Into 6mm Hole

Chevrolet Malibu

2004 - On

UNIT PACKAGE: 25

**Please Order In Unit  
Package Quantities  
Not Number Of Pieces**

# GENERAL MOTORS CLIPS & FASTENERS **Sec. 20**



**17162**

(GM: 96057846;  
Toyota: 90467-07041)  
Black Nylon

Push-Type Retainer  
Head Diameter: 15mm  
Stem Length: 13mm  
Fits Into 6.3mm Hole  
Geo Metro & Tracker  
1989-On

UNIT PACKAGE: 10



**19297**

(21035345)  
Black Nylon

Liftgate Upper Window  
& Lower Garnish Moulding  
Push-Type Retainer  
Head Diameter: 16mm  
Stem Length: (Exc. Pin): 12mm  
Fits Into 7mm Hole  
GM Saturn 1998 - 93

UNIT PACKAGE: 15



**11699**

(GM: 472434; Chry: 6031390)  
Black Nylon

Cowl Ledge  
Weatherstrip & Fender Liner  
Push-Type Retainer  
Head Dia: 11/16"  
Stem Length: 5/8"  
Fits Into 1/4" Hole  
GM 1970-On  
Chrysler 1968-On

UNIT PACKAGE: 50

Please Order In Unit  
Package Quantities  
Not Number Of Pieces



**19835**

(25646858)  
White Nylon

Door Panel Deflector  
Push-Type Retainer  
Head Diameter: 29/32"  
Stem Length: 21/32"  
Fits Into 11/32" Hole  
Cadillac Concours, DeVille  
& Seville  
1998 - On

UNIT PACKAGE: 25



**19892**

(25695687)  
Black Nylon

Radiator Support  
Sight Shield  
Push-Type Retainer  
Head Diameter: 27mm  
Shoulder Length: 7mm  
Stem Length: 18mm  
Fits Into 10mm Hole  
Cadillac DeVille & Seville  
2000 - On

UNIT PACKAGE: 15



**14011**

(14019226,  
14071289)  
Black Nylon

Radiator Overflow  
Bottle/Windshield  
Washer Bottle Retainer  
Head Dia: 21/32"  
Stem Length: 9/16"  
Fits Into 5/16" Hole  
GM 1981-On

UNIT PACKAGE: 25



**12567**

(GM: 14019205,  
14019206;  
Chry: 34201621)  
Black Nylon

Front Fender Mud Skirt  
& Fender Liner  
Push-Type Retainer  
Head Dia: 11/16"  
Stem Length: 9/16"  
Fits Into 1/4" Hole  
GM 1981 - On

UNIT PACKAGE: 25

**14007**

Same As 12567 Except Packing

UNIT PACKAGE: 50



**19847**

(5973823)  
Blue Nylon

Fascia Retainer  
Head Dia: 7/8"  
Shoulder Length: 5/32"  
Stem Length: 25/32"  
Fits Into 1/2" Hole  
GM 1979-On

UNIT PACKAGE: 25



**14010**

(14045480)  
Black Nylon

Fascia Retainer  
Head Dia: 1"  
Stem Length: 23/32"  
Fits Into 3/8" Hole  
GM 1982-On

UNIT PACKAGE: 25



**12757**

(5973400)  
Black Nylon

Fascia Retainer  
Head Dia: 1"  
Shoulder Length: 1/8"  
Stem Length: 3/4"  
Fits Into 1/2" Hole  
GM 1979-On

UNIT PACKAGE: 15

**16265**

Same as 12757 except packing

UNIT PACKAGE: 50

**Sec. 20****GENERAL MOTORS CLIPS & FASTENERS****12756**  
(5973996)  
Brown NylonFascia Retainer  
Head Dia: 1"  
Shoulder  
Length: 1/4"  
Stem Length: 7/8"  
Fits Into 1/2" Hole  
GM: 1982-On

UNIT PACKAGE: 15

**19522**  
(22644361)  
Black NylonDoor Sill Trim Plate  
Push-Type Retainer  
Head Diameter: 12mm  
Stem Length: 18mm  
Fits Into 6mm Square Hole  
Chev. Malibu, Olds Achieva &  
Cutlass  
1997 - On

UNIT PACKAGE: 15

**17222**  
(21075686)  
Black NylonPush-Type Retainer  
Head Diameter: 15mm  
Stem Length: 20mm  
Fits Into 8mm Hole  
Rocker Panel, Wheel Liner  
& Air Inlet Duct Applications  
GM Saturn  
2 Door & 4 Door Models  
1991-On

UNIT PACKAGE: 25

**19854**  
(21097229)  
Black NylonDoor Handle  
Push-Type Retainer  
Head Diameter: 7mm  
Stem Length: 10mm  
Fits Into 5mm Hole  
Saturn 2 Door & 4 Door  
1999 - On

UNIT PACKAGE: 25

**17106**  
(GM: 22566221;  
Chry: 6501577)  
Black NylonHeadlight Door Push-Type Retainer  
Large Head Dia: 1/2"  
Stem Length: 7/16"  
Fits Into 3/16" Hole  
GM Blazer & Suburban 1991 - On  
Chrysler New Yorker  
Landau & 5th Avenue 1988 - On

UNIT PACKAGE: 50

**17103**  
(GM: 15681408;  
Ford: N803709S)  
Black NylonFascia Retainer  
Head Dia: 15mm  
Stem Length: 23mm  
Fits Into 6mm Hole  
GM & Ford 1986-On

UNIT PACKAGE: 50

**14016**  
(GM: 16500308;  
Chry: 6500787)  
Black NylonTail Light Retainer  
Large Head Diameter: 3/8"  
Stem Length: 7/16"  
Fits Into 3/16" Hole  
GM & Chrysler

UNIT PACKAGE: 25

**19355**  
(15960621)  
Black NylonRear Door  
Radio Speaker  
Push-Type Retainer  
Head Diameter: 17/32"  
Stem Length: 1-5/64"  
Fits Into 1/4" Hole  
GM Trucks C & K 1, 2  
1995 - On

UNIT PACKAGE: 25

**17226**  
(10207146, 21077323)  
Black NylonRear Door Rocker Panel  
To Underbody Bracket  
Push-Type Retainer  
Head Diameter: 15mm  
Stem Length: 29mm  
Fits Into 8mm Hole  
GM Saturn  
4 Door Models  
1991 - On

UNIT PACKAGE: 25

**13999**  
(20363491)  
Black NylonBody Side Moulding  
Retainer  
Large Head Diameter: 3/8"  
Stem Length: 1/2"  
Fits Into 7/32" Hole  
GM 1979-On

UNIT PACKAGE: 25

**16816**  
(21047094)  
Black NylonPush-Type Retainer  
Large Head Dia: 14mm  
Stem Length: 14mm  
Fits Into 6mm Hole  
GM Saturn 1991 - On

UNIT PACKAGE: 25

Inquire About  
Our FasTrack Cost  
Recovery Program For  
Body Shops

# GENERAL MOTORS CLIPS & FASTENERS **Sec. 20**



**19801**  
(21077123)  
Black Nylon

Wheel Opening Moulding  
Push-Type Retainer  
Head Diameter: 19/32"  
Stem Length: 3/4"  
Fits Into 1/4" Hole  
Saturn  
1991 - On

UNIT PACKAGE: 25



**20542**  
(15994165)  
Black Nylon

Bumper & Rear  
Wheel Apron  
Push-Type Retainer  
Head Diameter: 16.5mm  
Stem Length: 27mm  
Fits Into 8mm Hole  
Saturn L Series  
2000 - On

UNIT PACKAGE: 25



**19639**  
(GM: 15149708;  
Chrys: 6506008AA)  
Black Nylon

Radiator, Wheelhouse,  
Fender & Front Bumper Cover  
Push-Type Retainer  
Head Diameter: 17mm  
Stem Length: 16mm  
Fits Into 6mm Hole  
GM C & K Trucks 1999 - On  
Jeep Liberty 2002 - On

UNIT PACKAGE: 25

**Please Order  
In Unit Package  
Quantities  
Not Number Of  
Pieces**

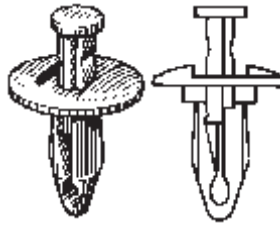

**16624**  
(1636632, 20687704)  
Black Nylon

Front Bumper  
Fascia Retainer  
Head Dia: 17mm  
Shoulder Length: 2mm  
Stem Length: 18mm  
Fits Into 9.5mm (3/8") Hole  
Buick Riviera/Reatta 1988-On

UNIT PACKAGE: 25



**18030**  
(Chry: 6501925;  
GM: 10134407)  
Black Nylon

Push-Type Retainer  
Head Size: 11/16"  
Stem Length: 13/16"  
Fits Into 1/4" Hole  
Chrysler Concorde & LHS  
Dodge Intrepid & Eagle Vision  
1993-On  
Coolant Recovery Reservoir  
GM 1992-On

UNIT PACKAGE: 25



**13993**  
(GM:20510029;  
Chry: 34202672)  
Black Nylon

Body Retainer  
Head Dia: 11/16"  
Stem Length: 7/8"  
Fits Into 1/4" Hole  
GM 1984-On

UNIT PACKAGE: 25



**13996**  
(20590899)  
Black Nylon

Exterior Body Retainer  
Head Dia: 11/16"  
Stem Length: 7/8"  
Fits Into 9/32" Hole  
GM 1984-On

UNIT PACKAGE: 25



**20365**  
(10301966, 10425306)  
Black Nylon

Cowl Vent  
Push-Type Retainer  
Head Diameter: 18mm  
Stem Length: 13mm  
Fits Into 7.5mm Square Hole  
Pontiac Aztek  
2001 - On

UNIT PACKAGE: 10



**16622**  
(10157900, 11517803,  
15993201)  
Black Nylon

Front Bumper  
Fascia Retainer  
Head Dia: 18mm  
Stem Length: 23mm  
Fits Into 9.5mm (3/8") Hole  
Olds Cutlass 1990-On  
GM Lt. Truck  
1996 - On

UNIT PACKAGE: 25

**Sec. 20****GENERAL MOTORS CLIPS & FASTENERS****20359**  
(11519444)  
Black NylonBumper Cover  
Push-Type Retainer  
Head Diameter: 18mm  
Stem Length: 26mm  
Fits Into 10mm Hole  
Oldsmobile Intrigue, Pontiac  
Aztek & Grand Prix  
1997 - On

UNIT PACKAGE: 25

**20631**  
(11588988)  
Black NylonFront Bumper Cover  
Push-Type Retainer  
Head Diameter: 18mm  
Stem Length: 26mm  
Fits Into 10mm Hole  
Pontiac Grand Prix  
2004 - On

UNIT PACKAGE: 25

**18308**  
(3540858)  
Black NylonRadiator Air Baffle  
Push-Type Retainer  
Large Head Diameter: 3/4"  
Stem Length: 1-1/8"  
Fits Into 1/4" Hole  
Cadillac Eldorado  
& Seville 1993-On

UNIT PACKAGE: 25

**17216**  
(GM: 21030249;  
Ford: N807389S;  
Chry: 6503598)  
Black NylonAir Baffle To  
Under Carriage  
Push-Type Retainer  
Head Diameter: 20mm  
Stem Length: 20mm  
Fits Into 8mm Hole  
GM Saturn  
2 Door & 4 Door  
Models 1991 - On

UNIT PACKAGE: 25

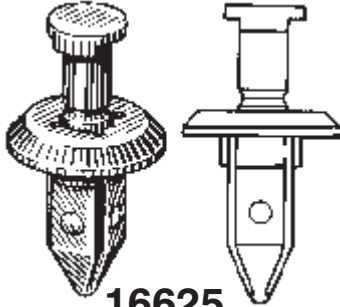
**16625**  
(10108746)  
Black NylonFront Bumper  
Fascia Retainer  
Head Dia: 20mm  
Stem Length: 20mm  
Fits Into 10mm Hole  
GM Station Wagons 1991-On

UNIT PACKAGE: 25

**19615**  
(15153415)  
Black NylonRear Bumper Cover  
Push-Type Retainer  
Large Head Dia.: 20mm  
Stem Length: 21mm  
Fits Into 9mm Hole  
C & K Trucks  
1999 - On

UNIT PACKAGE: 25

**20632**  
(GM: 11518017)  
Ford: W708530-S300)  
Black NylonBumper Cover &  
Fender Shield  
Push-Type Retainer  
Head Diameter: 20mm  
Stem Length: 26mm  
Fits Into 8mm Hole  
GM & Ford  
1997 - On

UNIT PACKAGE: 15

**18896**  
(21095797)  
Black NylonBumper Fascia  
Push-Type Retainer  
Large Head Dia.: 20mm  
Stem Length: 28mm  
Fits Into 8mm Hole  
GM Saturn 1996 - On

UNIT PACKAGE: 25

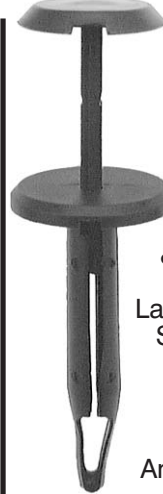
**20337**  
(24576759)  
Black NylonRadiator Air Baffle  
& General Purpose  
Push-Type Retainer  
Large Head Dia.: 20mm  
Stem Length: 39mm  
Fits Into 6mm Hole  
Chevrolet Malibu,  
Oldsmobile  
Alero & Cutlass  
And Pontiac Grand Am  
1999 - On

UNIT PACKAGE: 15

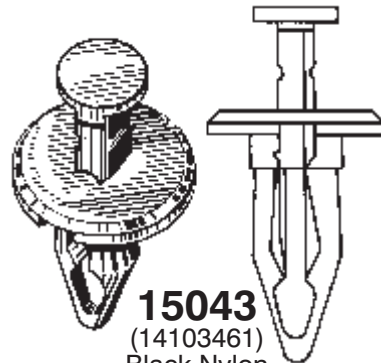
**15043**  
(14103461)  
Black NylonBumper Fascia Retainer  
Head Dia.: 7/8"  
Shoulder Length: 5/32"  
Stem Length: 1-3/64"  
Fits Into 1/2" Hole  
GM 1987 - On

UNIT PACKAGE: 25

**20379**  
(10159259)  
Black NylonFront Bumper Fascia  
Push-Type Retainer  
Head Diameter: 25mm  
Shoulder Diameter: 12.5mm  
Shoulder Length: 6mm  
Stem Length: 29mm  
Fits Into 12.5mm (1/2") Hole  
**Replaces Auveco 16621**  
Chevrolet Lumina APV &  
Oldsmobile Silhouette APV  
1996 - 90

UNIT PACKAGE: 25



# GENERAL MOTORS CLIPS & FASTENERS **Sec. 20**

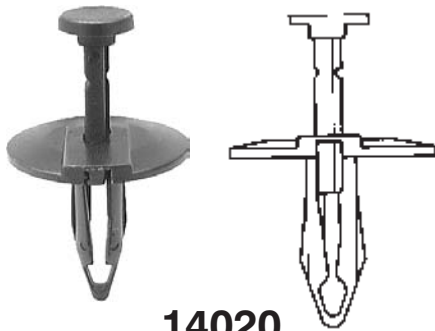

**14020**

(GM: 14093088;  
Ford: N802781-S)  
Black Nylon

Splash Shield & Fascia Retainer  
Head Dia: 1  
Stem Length: 7/8"  
Fits Into 1/4" Hole  
GM 1979 - On

UNIT PACKAGE: 25



**14147**

(20547865)  
Black Nylon

Body Retainer  
Head Dia: 1"  
Stem Length: 7/8"  
Fits Into 1/4" Hole  
GM 1984-On

UNIT PACKAGE: 25



**13994**

(GM: 20570245, 20635065  
Ford: N804614S)  
Black Nylon

Splash Shield, Seat Cushion &  
Spare Tire Retainer  
Head Dia: 1"  
Stem Length: 7/8"  
Fits Into 5/16" Hole  
GM 1984-On

UNIT PACKAGE: 25

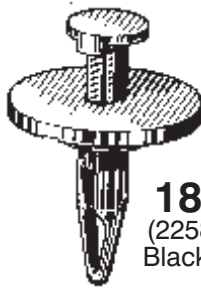

**18310**

(22587036)  
Black Nylon

Rear Bumper Fascia  
Push-Type Retainer  
Head Diameter: 1"  
Stem Length: 15/16"  
Fits Into 3/8" Hole  
Chevrolet Cavalier  
& Pontiac Sunfire  
1995 - On

UNIT PACKAGE: 25

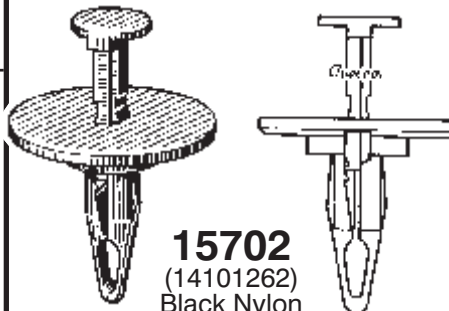

**15702**

(14101262)  
Black Nylon

Plastic Cover On Eng.  
Compartment Retainer  
Head Dia: 1"  
Shoulder Length: 1/8"  
Stem Length: 15/16"  
Fits Into 1/2" Hole  
Buick, Olds & Pontiac  
1988 - On

UNIT PACKAGE: 25



**15044**

(22535007)  
Black Nylon

Bumper Fascia Retainer  
Head Dia: 1"  
Shoulder Length: 1/8"  
Stem Length: 1"  
Fits Into 1/2" Hole  
GM 1987 - On

UNIT PACKAGE: 25



**15045**

(10053388,  
22542705)  
Black Nylon

Bumper Fascia  
Retainer  
Head Dia: 1"  
Shoulder  
Length: 1/8"  
Stem Length: 1-7/64"  
Fits Into 1/2" Hole  
GM 1987-On

UNIT PACKAGE: 25



**15042**

(10077283)  
Black Nylon

Bumper Fascia Retainer  
Head Dia: 1"  
Shoulder Length: 1/4"  
Stem Length: 1-1/8"  
Fits Into 1/2" Hole  
GM 1982-On

UNIT PACKAGE: 25



**18268**

(15959832)  
Black Nylon

Front License  
Plate Bracket  
Push-Type Retainer  
Head Diameter: 1"  
Shoulder  
Length: 9/64"  
Stem Length: 1-5/8"  
Fits Into 1/2" Hole  
GM Truck 1994-On

UNIT PACKAGE: 5

**Sec. 20****GENERAL MOTORS CLIPS & FASTENERS****18334**  
(15959833)  
Gray NylonFront License Plate  
Bracket Push-Type  
Retainer  
Head Diameter: 1"  
Stem Length: 1-3/4"  
Fits Into 1/2" Hole  
GM S-10 Truck  
With Decor Package  
1994-On  
UNIT PACKAGE: 5**20244**  
(25707329)  
Green NylonPush-Type Retainer With Sealer  
Head Diameter: 19mm  
Stem Length: 32mm  
Fits Into 8mm Hole  
Buick LeSabre, Oldsmobile Aurora  
& Pontiac Bonneville  
2000 - On  
UNIT PACKAGE: 10**12733**  
(20138524)  
NylonTail Light Retainer Nut  
GM 1982-On  
UNIT PACKAGE: 25**19530**  
(10281610)  
Black NylonAir Inlet Grille Panel Retainer  
Head Diameter: 30mm  
Fits Onto 5mm Stud  
Buick Century & Regal, Olds  
Intrigue and Pontiac Grand Prix  
1997 - On  
UNIT PACKAGE: 15**17616**  
(21077131)  
Black NylonBumper Fascia  
Push-Type Retainer  
Head Dia: 1-3/16"  
Stem Length: 2"  
Fits Into 7/16" Hole  
GM Saturn  
1991-On  
UNIT PACKAGE: 10**19387**  
(15989487)  
NylonFront & Rear Door  
Trim Panel Retainer  
**Used With 19388**  
Astro & Safari Mini-Van,  
S & T Trucks  
1996-On  
UNIT PACKAGE: 10**18678**  
(20565924)  
Black NylonDash Panel  
Insulation Retainer  
Head Diameter: 1-3/16"  
Fits Onto 3/16" Stud  
Buick Regal, Chevrolet Lumina,  
Olds Cutlass And  
Pontiac Grand Prix  
1988-On  
UNIT PACKAGE: 50**20163**  
(25099299)  
Black NylonRadiator Sight Shield  
& Air Filter Housing  
Push-Type Retainer  
Head Diameter: 12.5mm  
Stem Length: 17mm  
Fits Into 6mm Hole  
1994 - On  
UNIT PACKAGE: 15**19388**  
(15989484)  
NylonFront & Rear Door  
Trim Panel Retainer  
**Used With 19387**  
Astro & Safari  
Mini-Van,  
S & T Trucks  
1996-On  
UNIT PACKAGE: 10**18353**  
(15960325)  
White NylonDoor Trim Panel  
Push-Type Retainer  
Head Dia: 9/16"  
Stem length: 41/64"  
Fits Into 1/4" Hole  
GM Trucks C, K, 1, 2, 3  
1995-On  
UNIT PACKAGE: 50**13860**  
(20478294)  
Black NylonCarpet Retainer  
Head Dia: 30mm  
Fits Onto 6mm Stud  
GM 1984-On  
UNIT PACKAGE: 25**18691**  
(10186453)  
Black NylonDash Sound  
Barrier Retainer  
Flange Dia: 30mm  
Overall Length: 52mm  
Chevrolet Lumina APV, Olds  
Silhouette And Pontiac Trans Sport  
1990-On  
UNIT PACKAGE: 25



**16953**  
(12337900,  
14103435)  
Nylon

Upper Radiator  
Shield Retainer  
Chevrolet Corsica  
& Beretta  
1987-On

UNIT PACKAGE: 10



**19472**  
(GM: 25535963;  
Ford: N811772S)  
Nylon

Instrument Panel Insulation  
And Front Compartment  
Rear Sight Shield  
Turn Retainer

Buick Electra, LeSabre, Park Ave.  
& Skylark, Cadillac DeVille,  
Oldsmobile Achieva, Cutlass,  
Delta 88, 88 Royale & 98 Regency  
And Pontiac Bonneville  
& Grand Am  
1991 - On

Upper Deflector Shield  
Ford

UNIT PACKAGE: 25

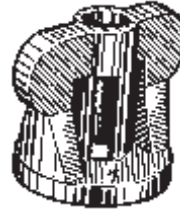

**13856**  
(20461373)  
Nylon

Rear Speaker Nut  
M6 - 1.0 Thread  
GM 1984-On

UNIT PACKAGE: 25

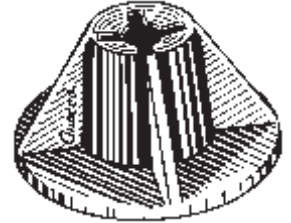

**13456**  
(20478295)  
Nylon

Carpet Retainer  
GM  
1985-On

UNIT PACKAGE: 10

## Wire Loom Routing Clips

Black Nylon Routing Clips for Wire Loom (also called split flexible tubing, convoluted conduit or wiring harness)



Type 1



Type 2



Type 3



Type 4



Type 6

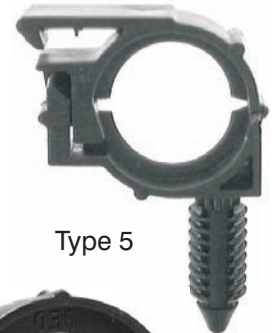

Type 5



Type 7

Auveco Part No.	Type	For Conduit Size		GM No.	Unit Pkg.
		I.D.	O.D.		
<b>19440</b>	3	1/4"	3/8"	12040984	15
<b>19795</b>	4	1/4"	3/8"	12015631	15
<b>14544</b>	1	1 11/32"	1/2"	8911473	25
<b>20471</b>	4	10mm	13mm	8905794	15
<b>20397</b>	6	10mm	13mm	12160858	15
<b>14545</b>	1	1 13/32"	1 19/32"	8911497	25
<b>14546</b>	1	1/2"	1 11/16"	8911472	25
<b>19851</b>	5	1/2"	1 11/16"	12040983	15
<b>14547</b>	1	3/4"	1"	3816659, 8917320	25
<b>20665</b>	7	19mm	24mm	12160374	15
<b>16941</b>	2	1"	1 9/32"	12015983	25

**Sec. 20**

**GENERAL MOTORS CLIPS & FASTENERS**



**19909**

(21170211)  
Black Nylon

Wire Routing Clip  
Stem Diameter: 9/32"  
Stem Length: 7/16"  
Saturn  
1996 - On

UNIT PACKAGE: 25

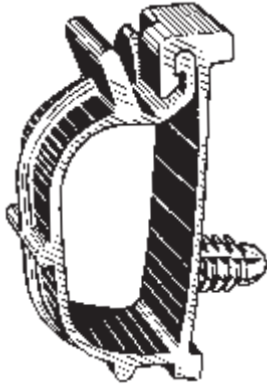

**13826**

(20491451)  
Nylon

Under Dash Routing Clip  
GM

UNIT PACKAGE: 10

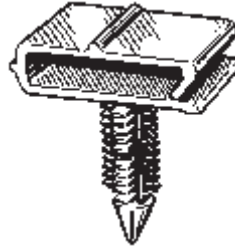

**13855**

(20418416)  
Nylon

Shear Wall Wire Clip  
Stem: 5/16" x 1" Long  
GM 1984-On

UNIT PACKAGE: 25



**14217**

(GM: 1257702,  
20346654;  
Ford: 383207-S;  
AMC: 3693099)  
Nylon

Routing Clip  
GM, Ford & AMC

UNIT PACKAGE: 25



**20514**

(12160857)  
Gray Nylon

Wiring Harness Clip  
Head Size: 9mm x 37mm  
Fits Into 6.3mm (1/4") Hole  
GM

UNIT PACKAGE: 50

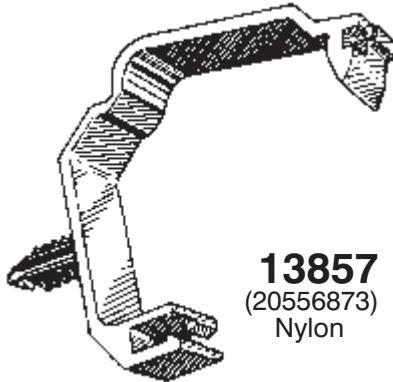

**13857**

(20556873)  
Nylon

Inside Door Wire Clip  
Stem: 1/4" x 7/32" x 9/16" Long  
GM 1984-On

UNIT PACKAGE: 25

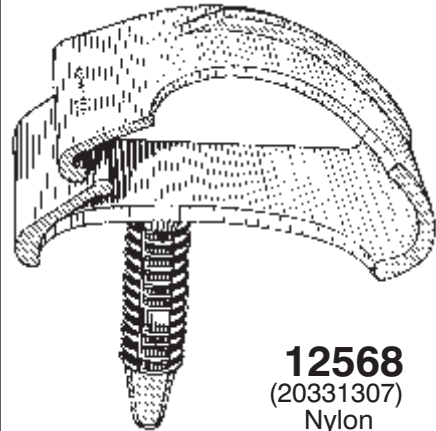

**12568**

(20331307)  
Nylon

Wire Routing Clip  
Stem: 5/16" x 11/32"  
x 1-1/4" Long  
GM 1981-On

UNIT PACKAGE: 10



**19853**

(12176844)  
Gray Nylon

Wiring Harness Clip  
Size: 3/8" x 2-1/2"  
Stem Length: 1/2"  
Fits Into 1/4" Hole  
GM

UNIT PACKAGE: 25

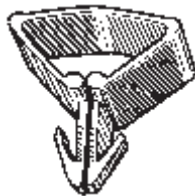

**13858**

(20430956)  
Nylon

Wire Clip  
Models With Sunroof  
GM 1984-On

UNIT PACKAGE: 25



**12728**

(14046480)  
Nylon

Wire  
Retaining Clip  
GM 1981-On

UNIT PACKAGE: 25

# GENERAL MOTORS CLIPS & FASTENERS **Sec. 20**



**12729**  
(25512081)  
Nylon

Engine Compartment  
Wire Clip  
For 1/4" Diameter Tube  
Buick w/ V-6 Diesel  
1985-On

UNIT PACKAGE: 25



**19221**  
(15638098)  
Nylon

Fuel Line  
Retainer Clip  
For 5/16" Fuel Hose  
1989-On

UNIT PACKAGE: 10



**19222**  
(15638097)  
Nylon

Fuel Line  
Retainer Clip  
For 3/8" Fuel Hose  
1989-On

UNIT PACKAGE: 10



**19902**  
(21097292)  
Natural Nylon

Hood Prop Rod Clip  
5/16" Rod Diameter  
Saturn  
1997 - On

UNIT PACKAGE: 15



**20312**  
(GM: 15021761;  
Chry: 5027550AB)  
Yellow Nylon

Hood Prop Rod Clip  
7mm Rod Diameter  
Snaps Into 10mm Hole  
GM Cars & Trucks 1988 - On  
Chrysler PT Cruiser  
Isuzu Hombre  
1990 - On

UNIT PACKAGE: 10



**11831**  
(554343,  
562327; 1241972)

Bumper Fastener  
GM 1973-On  
UNIT PACKAGE: 50



**The World's Largest  
Selection Of Body  
Hardware &  
Specialty Fasteners  
For The Collision  
Repair Professional**



**14968**  
(10005510)

Bumper Impact Strip  
Retainer  
GM 1978-On

UNIT PACKAGE: 50



**11352**  
(3920179,  
10013764)

Radiator Shroud Clip  
Chevrolet 1968-On

UNIT PACKAGE: 100



**18117**  
(10062366)

Retaining Clip  
Map Pockets & Dash  
GM 1990-On

UNIT PACKAGE: 25



**19200**  
(25606274)  
Zinc Organic

Side Marker, Parking  
Light & Rear Bumper  
Reflector Retainer  
Buick Riviera, Cadillac  
Eldorado & Oldsmobile Aurora  
1995-On

UNIT PACKAGE: 25

**Sec. 20****GENERAL MOTORS CLIPS & FASTENERS****19369**  
(3543865)  
Zinc OrganicBumper Filler Retainer  
Cadillac Seville  
1992-On

UNIT PACKAGE: 25

**20619**  
(15046306)  
Olive DrabRocker Panel Fastener  
Head Size: 7/16" x 1-7/16"  
Overall Height: 11/16"  
GM S & T Trucks  
2002 - On

UNIT PACKAGE: 15

**18262**  
(15002520,  
15682898)  
Zinc OrganicRadiator Grille Retainer  
GM Pickup, Van, Blazer, Jimmy  
1994-On

UNIT PACKAGE: 25

**19438**  
(10274528,  
10293836)Black Zinc Phosphate  
Bumper Fascia & Cooling  
Air Inlet Duct Fastener  
Cutlass, Grand Prix,  
Intrigue, Lumina, Monte  
Carlo & Regal  
1996-On

UNIT PACKAGE: 10

**18105**  
(15607139)Nameplate Retainer  
GM Trucks  
C & K 1987-On

UNIT PACKAGE: 15

Not Actual Size

**18748**  
(22527147)  
Black NylonRadiator Grille Retaining Clip  
Oldsmobile Calais &  
Delta 88 Royale 1986  
Pontiac Bonneville 1991-88

UNIT PACKAGE: 15

**19519**  
(16662182)  
Zinc OrganicWindshield Garnish Moulding,  
Rear Side Door Garnish Moulding  
& Liftgate Trim Finish Panel Fastener  
Chevrolet Camaro, Corvette, &  
Venture; Oldsmobile Silhouette and  
Pontiac Firebird, Grand Prix &  
Trans Sport  
1993 - On

UNIT PACKAGE: 15

**17356**  
(96061863)  
NylonRadiator Grille Clip  
Geo Tracker  
2 Wheel & 4 Wheel Drive  
1989-On

UNIT PACKAGE: 5

**19264**  
(22642007)  
PhosphateFender Bracket  
Retainer Nut  
#8 (M4.2-1.41) Screw Size  
Buick Skylark, Chevrolet  
Cavalier, Olds Achieva &  
Pontiac Sunfire  
1995-On

UNIT PACKAGE: 25

**20268**  
(15748479)  
Zinc & YellowGarnish Moulding Fastener  
Width: 1/2"  
Height: 5/8"  
GM Cars & Trucks  
1994 - On

UNIT PACKAGE: 25

**19616**  
(15025531;  
15764320)  
Black & Gray NylonRadiator Grille Retainer  
Long Head Dia.: 30mm  
Wide Head Dia.: 19mm  
Snaps Into 13mm Hole  
C & K Trucks  
1999-On

UNIT PACKAGE: 10

**18153**  
(15686142)  
Zinc PhosphateRadiator Grille Nut  
#8 Screw Size  
GM Trucks  
C & K, 1, 2 & 3  
1993-On

UNIT PACKAGE: 25

# GENERAL MOTORS CLIPS & FASTENERS **Sec. 20**



**14820**

(GM: 14083173,  
17988488, 17997722,  
Ford: N803685S)  
Phosphate

Dash Panel Nut  
Screw Size: #8 (M4.2-1.41)  
GM & Ford 1982-On

UNIT PACKAGE: 25



**19317**

(15707256)  
Zinc Organic

Front Fender Extension  
& License Plate Bracket  
Retainer Nut  
M6-1.0 Screw Size  
GM Express &  
Savanna  
1996-On

UNIT PACKAGE: 10



**20368**

(11517769)  
Zinc Organic

Door Trim Panel  
Retainer Nut  
M6-1.0 Screw Size  
Buick LeSabre; Cadillac  
DeVille & Seville; GM C & K  
Trucks and Oldsmobile Aurora  
1999 - On

UNIT PACKAGE: 10



**19502**

(10056725)  
Zinc Organic

Quarter Lower Trim Finish  
Panel Nut  
#8 Screw Size  
Buick Regal, Chev. Astro, Caprice,  
C & K Trucks, Lumina, Monte Carlo,  
& Safari, Olds Cutlass and Pontiac  
Grand Prix  
1988 - On

UNIT PACKAGE: 25

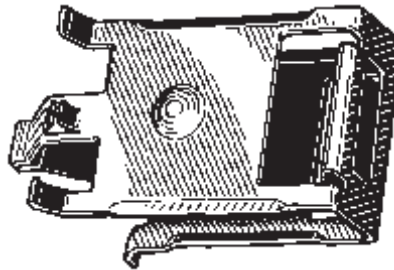

**17508**

(15632790)  
Zinc Organic

Grille Clip  
GM S-10 & S-15 Pick-Ups  
1991-On

UNIT PACKAGE: 5



**17382**

(14100784)  
Phosphate

Bumper Valance Panel Retainer  
Cadillac Eldorado & Seville  
Chevrolet Lumina & Beretta  
1987-On

UNIT PACKAGE: 25



**20396**

Zinc & Yellow

1/4" - 20 Specialty Insert  
Grip: .030" - .165"  
Head Diameter: 1/2"  
Hex Size: 3/8"

**Can be set with Auveco  
Tool 11805**

UNIT PACKAGE: 15



**20678**

Zinc & Yellow

M5-.8 Specialty Insert  
Grip: .5mm - 3.3mm  
Head Diameter: 10mm  
Hex Size: 7mm  
**Can be set with Auveco  
Tool 11805**

UNIT PACKAGE: 15



**19220**

(10237960)  
Zinc & Yellow

M6-1.0 Specialty Insert  
Grip: .7mm - 4.2mm  
Head Diameter: 12.5mm  
Inside Door Handle,  
Window Regulator &  
Air Bag Module Attachment  
Chevrolet Lumina, Monte  
Carlo & Pontiac Grand Prix  
1995-On

**Can be set With Auveco  
Tool 11805**

UNIT PACKAGE: 25



**20415**

(GM: 15685099;  
Ford: N803763-S100)  
Zinc & Yellow

M6-1.0 Specialty Insert w/ Sealer  
Grip: .65mm - 2.0mm  
Head Dia.: 12mm  
Hex Size: 8mm  
Roof Rack, Tailgate &  
General Purpose  
GM APV Vans, C & K Trucks  
And Ford Explorer 1991 - On

**Can be set with Auveco  
Tool 11805**

UNIT PACKAGE: 15



**20395**

(10281487)  
Zinc & Yellow

M6-1.0 Specialty Insert  
Grip: .7mm-4.2mm  
Head Diameter: 13mm  
Hex Size: 9.5mm (3/8")  
Front Fender  
Buick, Cadillac, Corvette,  
L.D. Truck, Olds Aurora  
And Pontiac  
1997 - On

**Can be set with Auveco  
Tool 11805**

UNIT PACKAGE: 15

**Sec. 20****GENERAL MOTORS CLIPS & FASTENERS****20451**(15990498)  
Zinc & Yellow

M6-1.0 Specialty Insert  
With Sealer  
Grip: .5mm-2.0mm  
Head Diameter: 12mm  
Hex Size: 8mm  
Luggage Rack  
GM APV's (Transport,  
Silhouette,  
Montana & Venture),  
C & K Trucks  
L & M Vans and Cadillac CTS  
1997 - On

**Can be set with Auveco Tool 11805**

UNIT PACKAGE: 10

**20422**(11519952)  
Zinc & Yellow

M6-1.0 Specialty Insert  
Grip: .7mm-4mm  
Head Diameter: 13mm  
Hex Size: 9.5mm (3/8")  
Front Core Support &  
General Purpose  
GM Envoy & Trailblazer  
2002 - On

**Can only be set with Pneumatic Tool**

UNIT PACKAGE: 15

**20423**(11519960)  
Zinc & Yellow

M8-1.25 Specialty Insert  
Grip: .7mm-4mm  
Head Diameter: 17mm  
Hex Size: 12.5mm (1/2")  
Front Core Support &  
General Purpose  
GM Envoy & Trailblazer  
2002 - On

**Can only be set with Pneumatic Tool**

UNIT PACKAGE: 15

**9367**

(4495047)

Front Seat  
Arm Support  
Hinge Pin Retainer  
GM

UNIT PACKAGE: 100

**15459**(1247872,  
15567924)

Throttle Rod  
Retaining Clip  
For 1/4" Rod w/ 5/32" Groove  
19/32" O.D.  
GM 1975-On

UNIT PACKAGE: 50

**15460**

(3989067)

Automatic Choke  
Rod To Carburetor  
Retaining Clip  
For 1/8" Rod  
1/2" O.D.

UNIT PACKAGE: 50

**9325**(3710401)  
Nylon

Gear Shift Lever Bushing  
1/2" I.D., 3/4" O.D.  
Chevrolet

UNIT PACKAGE: 25

**9469**(3764554)  
Nylon

Distributor To  
Oil Pump Intermediate  
Shaft Bushing  
Chevrolet 1965-On

UNIT PACKAGE: 25

**14924**

PVC Plastic

Door Lock Striker Bushing  
9/16" I.D., 11/16" O.D.  
3/4" Long  
GM 1977-On

UNIT PACKAGE: 25

**20562**

(9601750)

Door Lock Striker Bolt Assembly  
With PVC Plastic Bushing  
1/2" - 13 Thread  
Overall Length: 2-1/4"  
GM Cars & Trucks  
1991 - 73

UNIT PACKAGE: 1

**17069**(16606936,  
16633853)

White Nylon

Door Lock Rod Clip  
Rod Size: 4mm  
Head Dia: 10mm  
GM 1982-On

UNIT PACKAGE: 100



# GENERAL MOTORS CLIPS & FASTENERS **Sec. 20**



**19399**  
(16609280)  
Green Nylon

Door Handle Rod Clip  
Rod Size: 5/32"  
Buick Skylark, Chevrolet  
Caprice & Cavalier,  
Oldsmobile Achieva/Cutlass  
and Pontiac Grand Am &  
Sunfire  
1991-On

UNIT PACKAGE: 50



**18926**  
(14037239,  
15545178)  
Natural Nylon

Tailgate Rod Clip  
Rod Size: 3/16"  
GM Trucks C, K 1, 2, 3  
1981-On

UNIT PACKAGE: 10



**8275**  
Nylon

Brake Adjusting Screw  
Hole Nylon Plug  
Fits 3/8" x 1" Hole

UNIT PACKAGE: 100



**14967**  
(GM: 9815325,  
16607593;  
Ford: D2VZ-6521952A)  
Black Nylon

Door Lock Rod Clip  
Left-Hand Side  
Fits 5/32" Rod  
GM 1971-On  
Ford: 1972-On

UNIT PACKAGE: 50



**19658**  
(16629990,  
16675980)  
Gray Nylon

Door Lock Rod Clip  
Rod Size: 5/32"  
Buick, Cadillac, Chevrolet,  
Oldsmobile, Pontiac &  
Trucks  
1996 - On

UNIT PACKAGE: 15



**15518**  
(4234830, 12337868)

Door Lock Rod Clip  
GM 1964-On

UNIT PACKAGE: 25

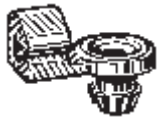

**18392**  
(20582532)  
Black Nylon

Door Lock Rod Clip  
Rod Size: 5/32"  
Buick Regal & Roadmaster  
Chevrolet Caprice, Olds Custom  
Cruiser & Cutlass And  
Pontiac Grand Prix  
1992-On

UNIT PACKAGE: 25



**19340**  
(3538281)  
Rubber

Air Inlet Screen  
Rubber Retainer  
Head Diameter: 1"  
Stem Length: 5/16"  
Fits Into 1/4" Hole  
Cadillac DeVille  
1992-On

UNIT PACKAGE: 10

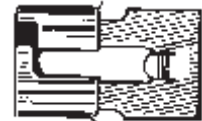

**15759**  
(3998009,  
9711304)

Door Lock Rod Clip  
GM 1956-On

UNIT PACKAGE: 50

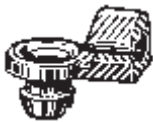

**18393**  
(20582533)  
Natural Nylon

Door Lock Rod Clip  
Rod Size: 5/32"  
Buick Regal & Roadmaster Chevrolet  
Caprice, Olds Custom Cruiser &  
Cutlass And  
Pontiac Grand Prix  
1992-On

UNIT PACKAGE: 25



**4406**  
Rubber

Brake Adjusting Screw  
Hole Rubber Plug  
Fits 5/16" x 1" Hole

UNIT PACKAGE: 25

**You Can E-Mail  
Your New Item  
Suggestions To  
mail@auveco.com**

**Sec. 20**

**GENERAL MOTORS CLIPS & FASTENERS**

**GM Truck**

**Door Hinge Pin & Bushing Repair Kit**

*For 2005 – 1999 Chevrolet Silverado, Suburban & Tahoe and GMC Sierra, Yukon and Yukon XL*



Why bother with the hassle of cutting and grinding off a worn door hinge and welding on a new one when you can repair the bad hinge in a fraction of the time?

With our new Door Hinge Pin & Bushing Repair Kit, fixing sagging doors caused by worn hinges due to pin failure is quick. It's easy. It works. And you don't have to repaint the welded heat flash area.

Each kit is designed to repair one hinge and contains two pins made of zinc plated machined cold rolled steel, two self-lubricating brass alloy bushings, two zinc plated nylon insert lock nuts and a zinc plated washer.

Here's how it works:

**20485**

Door Hinge Pin & Bushing Repair Kit

UNIT PACKAGE: 1 Kit



1. Remove the door from the truck body
2. Remove the original equipment pin and bushings
3. Install the bushings into the hinge holes
4. Install the longer pin into the top hinge hole
5. Thread on the lock nut
6. Install the shorter pin into the bottom hinge hole
7. Place the washer and a nut on the shorter pin
8. Tighten the nut to pull the pin into place.
9. Slowly tighten both upper and lower lock nuts
10. Reattach the door to the truck body

Detailed instructions are included with the kit.



Not Actual Size

**19725**

Not Available From O.E.M.  
Zinc

Door Roller Pin Assembly  
Diameter: 9/16"  
Length: 5-1/2"  
Roller O.D.: 3/4"  
Roller Groove Dia: 5/8"  
Knurl Dia: 19/32"  
GM C & K  
Light Duty Trucks  
2000 - 88

UNIT PACKAGE: 1



Not Actual Size

**19782**

(15672183)  
Zinc

Door Roller Pin Assembly  
Pin Diameter: 25/64"  
Overall Length: 5-1/16"  
Roller O.D.: 3/4"  
Roller Groove Diameter: 5/8"  
**Use With Auveco 8829 E-Type Retaining Ring**  
Rear Door Upper Hinge  
S & T Trucks  
1994 - On

UNIT PACKAGE: 1



Not Actual Size

**19781**

(15653790)  
Zinc & Yellow

Door Hinge Pin  
Length: 4-1/8"  
Pin Diameter: 11/32"  
Shoulder O.D.: 3/8"  
Head O.D.: 1/2"  
**Use With Auveco Bushings 16936 & 16937 & Pin Retainer 17976**  
S & T Trucks  
1994 - On

UNIT PACKAGE: 2

# GENERAL MOTORS CLIPS & FASTENERS **Sec. 20**

Not Actual Size



## 14559

(GM: 6271989,  
20046147)  
Phosphate

**Door Hinge Pin**  
**Length: 4-1/16"**  
**Pin Dia: 11/32"**  
**Head O.D.: 9/16"**

- Buick:** Estate Wagon & LeSabre Wagon 90-82, Electra 82, Regal 87-82, Riviera 85-82,  
**Cadillac:** All exc. Skyhawk 77-76; Cimarron 88-82, Eldorado & Seville 85-82, Fleetwood Brougham 92-82;  
**Chevrolet:** Camaro 81-78, C & K Trucks 84 - 73 Monte Carlo, Malibu & El Camino 88-76 Impala & Caprice 90-82, Nova 79-77;  
**Oldsmobile:** Cutlass Supreme, Calais & Cruiser 88-76, Delta 88 90-77, Omega 79-77, Toronado 85-82, 98 Recency 82-77;  
**Pontiac:** Firebird 81-78, Grand Prix 87-77, LeMans & Grand Am 81-77 Phoenix & Ventura 79-77, Safari & Parisienne 89-83  
**UNIT PACKAGE: 10**

Not Actual Size

## 19183

(GM: 20043351)  
Phosphate

**Door Hinge Pin**  
**Length: 4"**  
**Pin Dia: 11/32"**  
**Head O.D.: 7/16"**

- Buick:** Skyhawk 88-82, Skylark 85-82;  
**Chevrolet:** Cavalier 94-82, Celebrity 90-82, Chevette 87-78, Citation 85-80  
**Oldsmobile:** Cutlass Ciera 95-82, Firenza 88-82, Omega 84-80,  
**Pontiac:** Phoenix 84-80, Sunbird 94-82, T-1000 87-82 6000 91-82

**UNIT PACKAGE: 10**



Not Actual Size

## 19424

(15591860; 15691595;  
15967691; 88891731)  
Stainless Steel

**Door Hinge Pin**  
**Length: 5-1/4"**  
**Pin Dia: 11/32"**  
**Shoulder O.D.: 3/8"**  
**Head O.D.: 9/16"**  
GM Trucks  
C-K Models 1988-On  
**Use With Auveco**  
**Bushings 16936 & 16937**  
**& Pin Retainer 17976**

**UNIT PACKAGE: 4**



Not Actual Size

## 17343

(15646148)  
Stainless Steel

**Door Hinge Pin**  
**Length: 4-1/8"**  
**Pin Dia: 11/32"**  
**Shoulder O.D.: 3/8"**  
**Head O.D.: 9/16"**

- GM Trucks  
C-K 1,2,3  
4 Door Pick-Up  
Rear Door  
1992-On

**UNIT PACKAGE: 5**



**Sec. 20**

**GENERAL MOTORS CLIPS & FASTENERS**



Not Actual Size

**17344**

(15598845)  
Stainless Steel

Door Hinge Pin  
Length: 3-1/4"  
Pin Dia: 11/32"  
Head O.D.: 1/2"  
GM Astro &  
Safari Mini-Vans  
Rear Door  
1985-On

UNIT PACKAGE: 5



Not Actual Size

**17436**

(10102434)  
Phos. & Oil

Trunk Lid Hinge Pin  
Length: 2-21/32"  
Pin Dia: 11/32"  
Head O.D.: 15/32"  
Buick Regal, Cadillac,  
Eldorado & Seville,  
Chevrolet Lumina,  
Oldsmobile Cutlass  
& Pontiac Grand Prix  
1988-On

UNIT PACKAGE: 10



**17976**

(15562610)  
400 Series  
Stainless Steel

Door Hinge Pin Retainer  
21/64" I.D., 9/16" O.D.  
1/64" Thick  
GM Trucks C-K  
1988-On

**Used With 19424 & 19781  
Door Hinge Pin**

UNIT PACKAGE: 50



Not Actual Size

**17345**

(12337927, 15537954,  
15660361)  
Zinc

Door Hinge Pin  
Length: 4-13/16"  
Pin Dia: 15/64"  
Head O.D.: 7/16"  
GM Suburban &  
4 Door Jimmy/Blazer  
End Gate  
1992-On

UNIT PACKAGE: 5



**17437**

(12338015,  
14066728)  
Zinc & Yellow

Door Hinge Pin  
Length: 4-5/32"  
Pin Dia: 11/32"  
Head O.D.: 15/32"  
GM Astro Van,  
Safari Van & S-10  
1982-On

UNIT PACKAGE: 5



Not Actual Size

**17435**

(20558726)  
Zinc & Black

Lift Gate Hinge Pin  
Length: 3-5/8"  
Pin Dia: 3/16"  
Head O.D.: 13/32"  
Buick Century,  
Chevrolet Celebrity,  
Oldsmobile Ciera  
& Pontiac 6000  
Station Wagons  
1984-On

UNIT PACKAGE: 5



## Door Hinge Bushings

Auveco Part No.	Dimensions			
	O.D. "A"	I.D. "B"	Height "C"	Flange O.D. "D"
<b>14548</b>	1/2"	3/8"	15/32"	5/8"
<b>14549</b>	1/2"	11/32"	3/8"	19/32"
<b>14550</b>	27/64"	11/32"	19/64"	19/32"
<b>14553*</b>	31/64"	11/32"	23/64"	19/32"
<b>16936*</b>	1/2"	11/32"	23/64"	43/64"
<b>16937*</b>	17/32"	25/64"	23/64"	11/16"

\*Splined O.D.



**14548**  
(9822198)

Buick 1975-42  
Chevrolet:  
  Monza & Vega  
  1980-76  
  All (Exc. Corvette)  
  1975-62  
Olds Starfire 1980-76  
Pontiac:  
  Astre &  
  Sunbird 1980-76  
  All 1975-49  
  
UNIT PACKAGE: 25



**14549**  
(9716926, 20345137)  
Thick Bushing

Buick 1976-On  
Cadillac 1980-On  
Chevrolet:  
  All 1976-On  
  Corvette 1982-73  
Olds  
  Exc. Starfire 1980-On  
Pontiac Exc. Astre &  
  Sunbird 1980-On  
  
UNIT PACKAGE: 25



**14550**  
(GM: 9721917;  
Ford: D1AZ-6522841A)

Buick (Exc. Skyhawk)  
  1967-On  
Cadillac 1946-On  
Chevrolet:  
  Exc. Monza & Vega  
  1962-On  
  Corvette 1956-On  
GM  
  C & K Trucks 1993 - 79  
Olds Exc.  
  Starfire 1949-On  
Pontiac Exc. Astre &  
  Sunbird 1932-On  
  
UNIT PACKAGE: 25



**14553**  
(20429500)

Splined O.D.  
All GM (Including  
Pick-Ups & Vans) 1968-On  
  
UNIT PACKAGE: 25



**16936**  
(12338074, 15691493, 15964971, 16632193)

Splined O.D.  
Side Door Upper Hinge  
GM Trucks  
C-K Models 1988-On  
  
UNIT PACKAGE: 25



**16937**  
(15562609, 15964972 & 16632192)

Splined O.D.  
Side Door Lower Hinge  
GM Trucks  
C-K Models 1988-On  
  
UNIT PACKAGE: 25

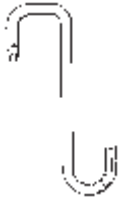
**Truck Door Hinge Spring**

Not Actual Size

**14555**Right (Passenger's) Side  
5-3/4" Long

UNIT PACKAGE: 2

**12314**  
(20037597)Clear Knob  
GM 1952-On

UNIT PACKAGE: 1

**12315**  
(1732326)Black Knob  
GM 1952-On

UNIT PACKAGE: 1

**12316**  
(458030)

GM Trucks 1977-On

UNIT PACKAGE: 1

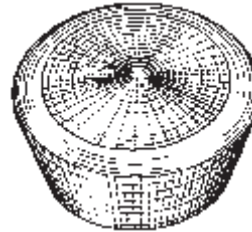
**18195**  
ClearWindow Crank  
Handle Knob  
GM 1952-On

UNIT PACKAGE: 2

**HELPFUL HINTS.....****FOR USING THE AUVECO CATALOG**

1. The color-coded pages signify various sections:  
 BLUE-Metric Items  
 BEIGE-Electrical Accessories  
 GREEN-Assortments, Cabinets, Bins & Racks  
 GRAY-Key Blanks & Accessories  
 PINK-Import Car Body Hardware
2. Most illustrations are actual size. You should be able to set a part on top of the illustration to positively identify it.
3. Our Display Boards, which are shown on the four-color pages in the front of the catalog, are a great aid in identifying product.
4. We have three different indexes in the front of the catalog to assist you.  
 PICTORIAL QUICK INDEX  
 ALPHABETICAL INDEX  
 NUMERICAL INDEX
5. There are two OEM Part Number To AUVECO Part Number Cross References at the back of the catalog.

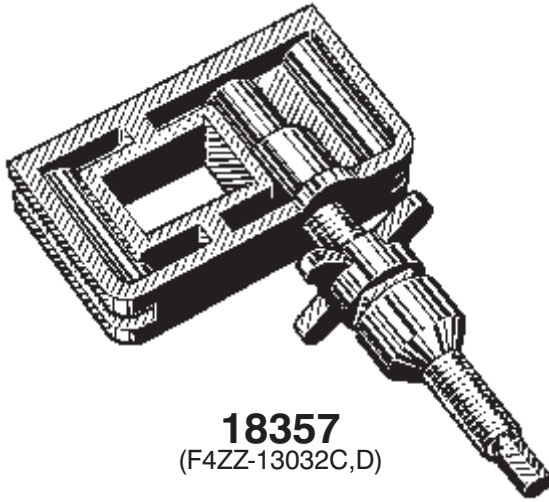

**18357**  
(F4ZZ-13032C,D)  
Headlight Vertical Adjuster  
Mustang  
1994-On

UNIT PACKAGE: 2



**18739**  
(F37Z-13032-A)  
Headlight Pivot Adjuster  
Ford Ranger  
1993-On

UNIT PACKAGE: 2

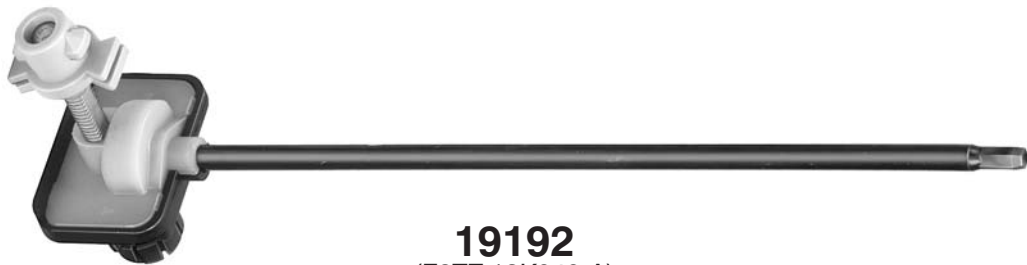

**19192**  
(F2TZ-13K040-A)  
Headlight Adjusting Assembly  
Ford F150, 250, 350 & Bronco  
Lower Adjusting Arm  
1992-On

UNIT PACKAGE: 1

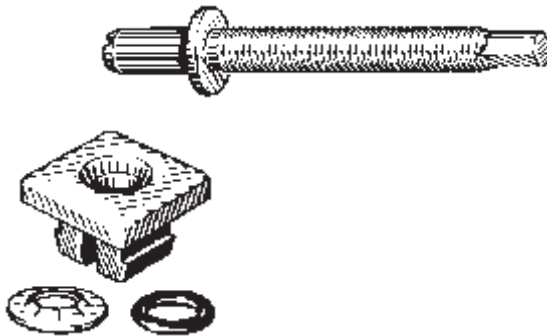

**15968**  
(E6DZ-13032A)  
Adjusting Screw Assembly  
Hex & Slotted Drives  
Taurus & Sable 1988-86

UNIT PACKAGE: 10

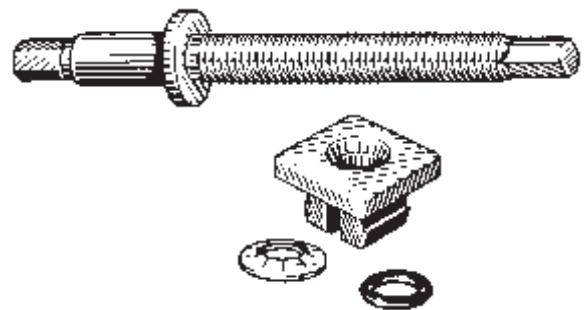

**15969**  
(E6DZ-13032B,C)  
Adjusting Screw Assembly  
Hex Drives  
Taurus & Sable 1986-On

UNIT PACKAGE: 10

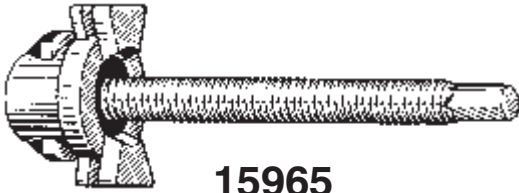

**15965**

(E7SZ-13032-C, E83B-13A093CA, E83Z-13032B)

#12 -28 x 2-1/8"  
Adjusting Screw Assembly  
R.H. Lower, L.H. Upper  
Hex & Phillips Drives  
T-Bird, Cougar & Continental 1988-87  
Vertical Adjustment  
Tempo & Topaz 1989-88

UNIT PACKAGE: 5



**16402**

(E7TZ-13032A, E7TB-13A093AB)

Upper Screw & Nut, Trucks F-U 150/350 1987-On

UNIT PACKAGE: 5

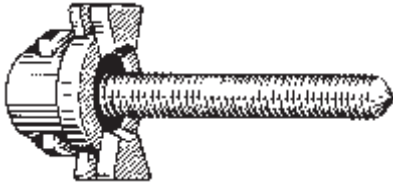

**15966**

(E7SZ-13032-D)

#12 -28 x 1-1/2"  
Adjusting Screw Assembly  
R.H. Upper, L.H. Lower  
Phillips Drive  
T-Bird, Cougar &  
Continental 1988-87

UNIT PACKAGE: 5

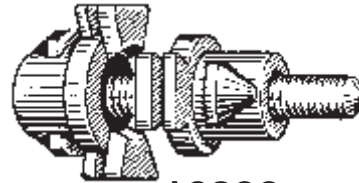

**16399**

(E9TZ-13032B, E97B-13A093BA)

Black Screw

Bronco & Ranger 1989-On

UNIT PACKAGE: 5

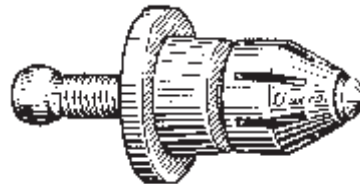

**16406**

(E9WY-13032C, E9WB-13A093CA)

Pivot Point Adjuster  
Cougar 1989-On

UNIT PACKAGE: 10

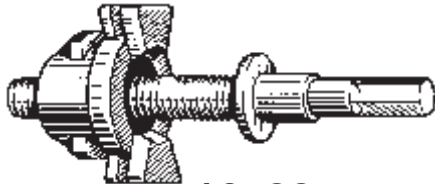

**16733**

(F03Z-13032A,  
E83B-13A093-AA)

Vertical Adjuster  
Tempo & Topaz 1990-On

UNIT PACKAGE: 5



**16397**

(E8FZ-13032B, E8EB-13A093BA)

Horizontal Adjuster, Escort & Lynx 1990-88

UNIT PACKAGE: 5

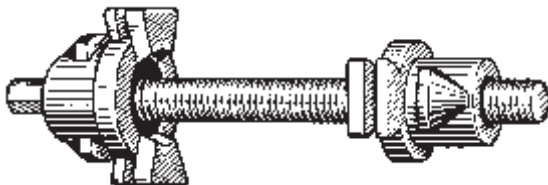

**16396**

(E8FZ-13032A, E8EB-13A093AA,  
E8EB-13A093AB)

Vertical Adjuster, Escort & Lynx 1990-88

UNIT PACKAGE: 5



**16405**

(E9WY-13032B, E9WB-13A093BA)

Vertical Adjuster  
Cougar 1989-On

UNIT PACKAGE: 10





**11660**  
(DOZB-13A-093-AA)  
Phosphate

1/4"-28 x 2"  
Headlight Adjusting Screw  
& Nut Assembly  
Ford Cars & Medium Duty Trucks  
1973-On

UNIT PACKAGE: 10

**11661**

Same as 11660  
Except Packing

UNIT PACKAGE: 25



**12609**  
(D9ZB-13A093 AA)

#12-28 x 1-3/4"  
Headlight  
Adjusting Screw  
& Nut Assembly  
Ford 1979-On

UNIT PACKAGE: 10

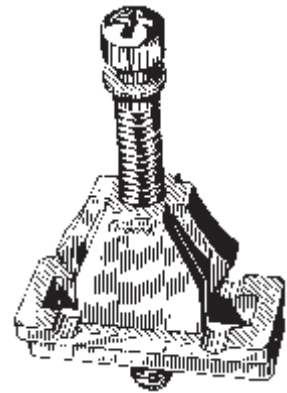

**11869**  
(D8BZ-13032A, B,  
D8BB-13M-093AA)  
Zinc

#12-28 x 1-3/4"  
Headlight Adjusting  
Screw & Nut Assembly  
Ford 1978-On

UNIT PACKAGE: 10

**11870**

Same as 11869 Except Packing

UNIT PACKAGE: 100

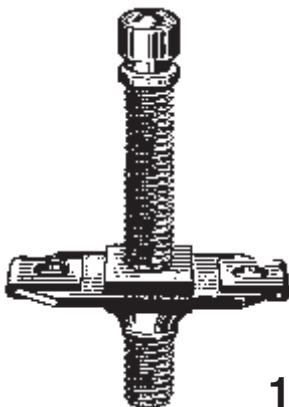

**11662**  
(DITZ-13032B,  
D70Z-13032B,  
D7SZ-13032A,  
D70B-13A-093-AA)  
Phosphate

1/4"-28 x 1-3/4"  
Headlight  
Adjusting Screw  
& Nut Assembly  
Ford 1973-On

UNIT PACKAGE: 10

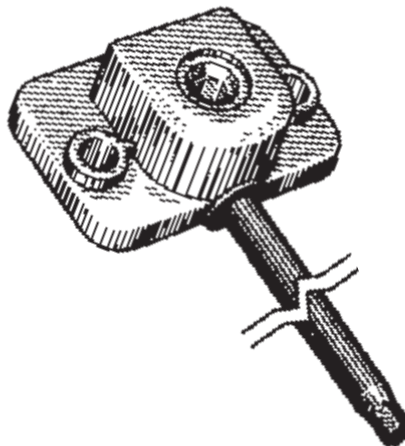

**15634**  
(E6DZ-13K040-B)

Headlight Adjuster  
Escort & Lynx 1985-On  
Sable & Taurus 1986-On

UNIT PACKAGE: 1



**17457**  
(E92Z-13032B)  
Zinc & Black

M5-.8 x 40mm  
Headlight Adjusting Screw  
Horizontal Adjuster  
Ford Probe  
1988-On  
**Use With Auveco Nut 14358**

UNIT PACKAGE: 10

**FasTrack  
Auveco's Cost  
Recovery System For  
Repair Fasteners**

**Never Lose Money  
On Fasteners Again!**



**11669**  
(DZAB-13021-AA)  
Black Phos.

1/4"-28 Thread  
Headlamp Adjusting Nut Mount  
Light Duty Trucks 1976-On

UNIT PACKAGE: 25



**18263**  
(F37Z-13N129-A)  
Black

Headlight Component  
Retaining Clip  
Mustang & Ranger 1993-On

UNIT PACKAGE: 25

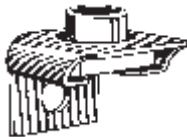

**12228**  
(FDA13021-A)  
Zinc-Nylon Nut

1/4"-28 Thread  
Headlight Adjusting Nut Mount  
Ford Product 1980-On

UNIT PACKAGE: 10



**18899**  
(F1CZ-13A147A)  
Black Nylon

Headlight Pivot Socket  
Escort & Tracer  
1991-On

UNIT PACKAGE: 25



**15814**  
(E5LB-13A147AA,  
E5LY-13A147A)

Headlight Adjuster Retainer  
Escort & Lynx 1985-On  
Lincoln Mark VI, VII 1985-On  
Mercury 1985-On  
Tempo & Topaz 1986-On

UNIT PACKAGE: 25

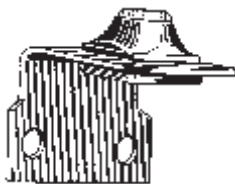

**12227**  
(D2KB-13021-AA)  
Zinc  
Nylon Nut

1/4"-28 Thread  
Headlight Adjusting Nut Mount  
Ford Product 1980-On

UNIT PACKAGE: 25



**15940**  
(E9DB-13N020AA, E9DZ-13N129A)

Headlight Component  
Pivot Retaining Clip  
Ford Taurus & T-Bird 1989-On  
Mercury Cougar & Sable  
1989-On

**Use Auveco Tool 19269 To  
Remove & Install Clip**

UNIT PACKAGE: 25



**19180**  
(F75Z-13N129-AA)

Headlight Mounting Bracket  
Ford F150, F250 & Expedition  
1997-On

UNIT PACKAGE: 5

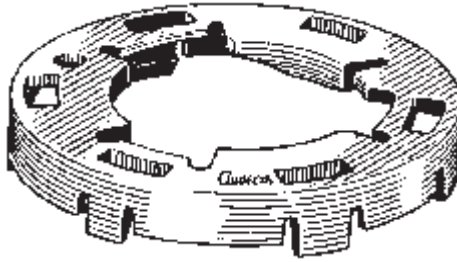

**16425**  
(E9SZ-13N019B,  
E9SB-13N019-BA)  
Nylon  
High Beam 9005 Bulb Retainer  
Ford T-Bird & Cougar 1989-On  
UNIT PACKAGE: 10



**10716**  
(C20Z-13031-A)  
Headlight Adjusting Spring:  
Ford 1971-On  
UNIT PACKAGE: 25



**14768**  
(D9BZ-5401316-B)  
Black Nylon  
Cowl Panel Grommet  
#6 Screw Size  
Fits Into 9/32" x 7/16" Hole  
Ford 1979-On  
UNIT PACKAGE: 25



**19280**  
Black Nylon  
Door Window Glass  
To Regulator Nut  
Contour & Mystique  
1995-On  
UNIT PACKAGE: 5



**14755**  
(379830-S)  
White Nylon  
3/8" Wide, 3/8" Long  
#8 Screw Size  
Fits Into 1/4" Sq. Hole  
Ford 1986-On  
UNIT PACKAGE: 25

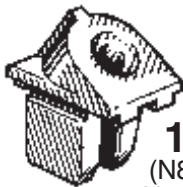

**18155**  
(N803768-S)  
Natural Nylon  
Door Arm Rest Nut  
#8 Screw Size  
Mustang & Capri  
1987-On  
UNIT PACKAGE: 15

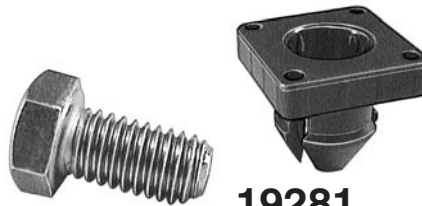

**19281**  
(F5RZ-5421416B)  
Door Window Glass  
To Regulator Fastener  
Assembly  
3/8"-16 x 3/4" Grade 8  
Cap Screw  
Contour & Mystique  
1995-On  
UNIT PACKAGE: 2 Sets



**18383**  
(W700566-S300)  
Natural Nylon  
#12 Screw Size  
Back Panel Attachment  
Contour & Mystique  
1995-On  
UNIT PACKAGE: 25



**18384**  
(W700800-S300)  
Black Nylon  
Nylon Grommet  
Back Lower Finish  
Panel Assembly  
Contour & Mystique  
1995-On  
UNIT PACKAGE: 50



**9862**  
(379830-S)  
White Nylon  
Headlight Door, Grille  
& Mirror Nut  
#8 or #10 Screw Size  
Fits Into 1/4" Sq. Hole  
Ford  
UNIT PACKAGE: 50



**11865**  
(GM: 1255823;  
Ford: 389360S)  
Natural Nylon  
Tail Light Nut  
#6 or #8 Screw Size  
Ford 1981-On  
Front End Bezel Nut  
GM 1979-On  
UNIT PACKAGE: 50

**Sec. 20****FORD PRODUCTS CLIPS & FASTENERS****14358**(Ford: E92Z-13A147A;  
Mazda: 0483-66-061-A)  
Natural NylonHeadlight Nut  
#10 Screw Size  
13mm Wide; 13mm Long  
Snaps Into 8mm x 8mm Hole  
**Use With Auveco Screw 17457**  
Ford Probe 1989-On

UNIT PACKAGE: 25

**12569**(Ford: N801706-S;  
Chry: 6501773)  
Black NylonFord 1981-On  
#10 Screw Size

UNIT PACKAGE: 25

**14756**(Ford: 379830-S;  
Chry: 6033677)  
Black Nylon3/8" Wide, 3/8" Long  
Fits Into 9/32" x 9/32" Hole  
Panel Thickness: 1/4"  
#8 Screw Size  
Ford & Chrysler 1986-On

UNIT PACKAGE: 25

**14754**(N802376-S)  
Blue Nylon1/4" Long, 3/8" Wide  
Fits Into 7/32" x 7/32" Hole  
Panel Thickness: 5/32"  
#8 Screw Size  
Ford

UNIT PACKAGE: 25

**Please Order  
In Units  
Not Pieces****20245**(N806334-S)  
Natural NylonNylon Nut  
M4.2 (#8) Screw Size  
Head Size: 10mm x 10mm  
Fits Into 6mm Square Hole  
Ford  
1999 - On

UNIT PACKAGE: 50

**19277**(N804765-S)  
Natural NylonWheel Opening  
Screw Grommet  
#8 (M4.2) Screw Size  
Mustang, T-Bird, Cougar &  
Continental  
1993-On

UNIT PACKAGE: 50

**20393**(W706575-S300)  
Natural NylonDoor Panel Screw Grommet  
M4.2 (#8) Screw Size  
Stem Length: 20mm  
Fits Into 10mm Square Hole  
Ford Escape  
2001 - On

UNIT PACKAGE: 50

**20425**(F5RZ-17K657-A)  
Natural NylonWindshield Washer  
Reservoir Mounting  
Screw Grommet  
Use with #12 Screw  
Head Dia: 1"  
Overall Length: 13/16"  
Fits Into 3/8" Sq. Hole  
Ford Contour, Focus & Mystique  
1995 - On

UNIT PACKAGE: 25

**19326**(N807706-S)  
Natural NylonFront Bumper  
Fascia Grommet  
Escort, Explorer  
& Mustang  
1996-On

UNIT PACKAGE: 25

**20532**(W708045-S300)  
Black RubberRear Bumper Cover  
Grommet  
Head Diameter: 15mm  
Stem Length: 21mm  
Fits Into 9.5mm Hole  
**Use With Auveco 20531**  
Ford Expedition 2003 - On

UNIT PACKAGE: 25

**11841**(N-800503S)  
Black NylonGrille Attachment Nut  
#6 Screw Size  
Ford 1978-On

UNIT PACKAGE: 50

**19267**(N806577-S)  
Natural NylonInterior Trim Panel  
Screw Grommet  
#8 (M4.2) Screw Size  
E150/350 Vans  
1992-On

UNIT PACKAGE: 50



**19364**  
(N806795-S)  
White Nylon

Headliner & Pillar  
Trim Panel Grommet  
Taurus & Sable  
1992-On

UNIT PACKAGE: 50



**20264**  
(N806363-S)  
White Nylon

Kick Panel Grommet  
Head Dia: 23mm  
Overall Length: 24mm  
**Used With Auveco Retainers**  
**19760, 19761, 19762 & 19763**  
Ford Ranger  
1993-On

UNIT PACKAGE: 25

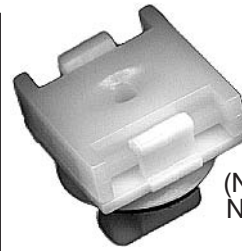

**20171**  
(N807189-S100,  
N811353-S100)  
White Nylon

Cowl Vent Grommet  
M4.2 (#8) Screw Size  
Fits Into 10mm x 14mm Hole  
F150 Pickup, Expedition  
& Windstar  
1995 - On

UNIT PACKAGE: 10



**20466**  
(GM: 25649667;  
Ford:  
W705590-S300)  
Natural Nylon

Screw Grommet  
With Sealer  
M4.2 (#8) Screw Size  
Head Size: 13mm x 22mm  
Stem Length: 18mm  
Back Glass Moulding  
& Interior Trim  
Cadillac & Ford Windstar  
1998 - On

UNIT PACKAGE: 15



**17317**  
(F1CZ-8A188-A)  
Black Nylon

Radiator Grille Spacer  
Ford Escort & Mercury Tracer  
1991-On

UNIT PACKAGE: 25



**19138**  
(Ford: F1CZ-5802316A;  
Mazda: BW0A-50-792)  
Black Nylon

Cowl Top Vent Grille Retainer  
Ford Escort & Tracer  
Mazda  
1991-On

UNIT PACKAGE: 15



**20517**  
(W707606-S300)  
Black Nylon

Rear Bumper Cover  
Screw Grommet  
M4.8 (#10) Screw Size  
Head Size: 18mm x 24mm  
Stem Length: 14mm  
Ford Escape  
2001 - On

UNIT PACKAGE: 15



**20530**  
Not Available From O.E.M.  
Black Nylon

Radiator Shroud  
Air Deflector Retainer  
Head Diameter: 20mm  
Stem Diameter: 13mm  
Stem Length: 16mm  
Ford Expedition  
2003 - On

UNIT PACKAGE: 50



**19238**  
(F6DZ-5402316-AA)  
Natural Nylon

Cowl Top Vent Grille  
Grommet

**Use With Auveco 19237**  
Ford Taurus & Sable  
1996-On

UNIT PACKAGE: 50



**20336**  
(F7CZ-17C756-BA)  
Black Nylon

Front & Rear  
Bumper Cover Grommet  
Use With #12 Screw  
Stem Length: 1/2"  
Escort & Tracer  
1997 - On

UNIT PACKAGE: 15



**17195**  
(Isuzu: 8942180270)  
Black Nylon

Grille Clip  
13mm Wide, 22mm Long  
Ford Escort, Honda,  
Isuzu, Mitsubishi & Plymouth Laser

UNIT PACKAGE: 25



**19237**  
(W701649-S,  
W704881-S300)  
Black Nylon

Cowl Top Vent Grille  
Nylon Screw  
#10 x 1-1/32"  
9/16" Head O.D.

**Use With Auveco 19238**  
Ford Taurus & Sable  
1996-On

UNIT PACKAGE: 50



**19517**  
(N811849-S300)  
Black Nylon

Cowl Top Vent Grille  
Nylon Screw  
#10 x 2-1/16"  
9/16" Head O.D.  
Ford Trucks  
1998 - On

UNIT PACKAGE: 25



**17551**  
(Mazda: GJ21-50-H81)  
Natural Nylon

Cowl Screen Grommet  
Ford Probe 1988-On  
Mazda 626 & MX6 1988-On

UNIT PACKAGE: 25



**17552**  
(Mazda: GJ21-50-H82)  
Natural Nylon

Cowl Screen Grommet  
Ford Probe 1988-On  
Mazda 626 & MX6 1988-On

UNIT PACKAGE: 25



**17553**  
(Mazda:  
KA01-50-H16)  
Yellow Nylon

Rear Hatch Grommet  
Ford Probe 1988-On  
Mazda MX 6 1988-On  
**Use With 17554**

UNIT PACKAGE: 25



**17554**  
(Mazda: KA01-50-H15A)  
Black Nylon

Rear Hatch Retainer  
Ford Probe 1988-On  
Mazda MX6 1988-On  
**Use With 17553**

UNIT PACKAGE: 25



**18816**  
(N807994-S)  
Black Nylon

Grille & Side Marker  
Light Grommet  
Fits Into 10mm Hole  
Ford 1994-On

UNIT PACKAGE: 50



**19526**  
(N807247-S)  
Natural Nylon

Rear Door & Back Window  
Trim Panel Grommet  
#12 - 24 Screw  
Fits Into 1/2" Hole  
Lincoln Town Car  
1990 - On

UNIT PACKAGE: 25



**19783**  
(N811169S,  
W705550-S300)  
White Nylon

Park & Turn Signal  
Housing Grommet  
7/32" Stud Size  
Head Diameter: 13mm  
Stem Length: 9mm  
Fits Into 11mm Hole  
F250 - F550 Trucks  
1999 - On

UNIT PACKAGE: 50

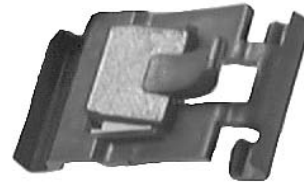

**19752**  
(Not Available  
From O.E.M.)  
White Nylon

Door Belt Moulding Clip  
Taurus, Sable  
Contour & Mystique  
1998 - 95

UNIT PACKAGE: 15

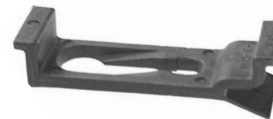

**20400**  
(YF4Z-8194-AA)  
Nylon

Radiator Grille Clip  
Width: 11/32"  
Length: 1-9/32"  
Mercury Sable  
2000 - On

UNIT PACKAGE: 15



**19154**  
(E2EB-61290C62-AA)  
Nylon

Body Side Moulding Clip  
Escort & Lynx  
1981-On

UNIT PACKAGE: 25



**17451**  
(Mazda: H001-68-719B)  
Nylon

Rocker Scuff Plate Retainer  
Ford Probe 1988-On  
Mazda MX6 1988-On

UNIT PACKAGE: 25



**12559**  
(D5UB-2221066AA)  
Nylon

Moulding  
Ford 1980-On  
UNIT PACKAGE: 50

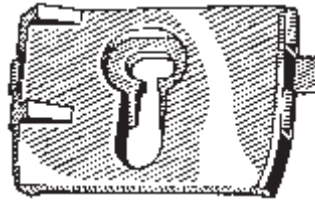

**14213**  
(D42B-6021066BA)  
Nylon

Mustang Body Side Moulding  
UNIT PACKAGE: 25



**20358**  
(F6DZ-5410182-AA)  
Black Nylon

Rocker Panel Moulding Clip  
Head Size: 13mm x 39mm  
Stem Length: 14mm  
Fits Into 9mm Hole  
Sable, Taurus & Lincoln LS2000  
1996 - On

UNIT PACKAGE: 10

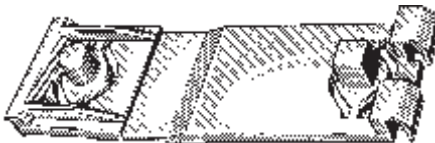

**15812**  
(E7ZB-6120908AC)  
Nylon

Door Retainer/Outside  
Belt Moulding Clip  
Ford Mustang 1987-On  
UNIT PACKAGE: 50



Not Actual Size

**17066**  
(F2AB-5410182-AB)  
Nylon

Rocker Panel Moulding Clip  
1-3/16" Wide x 3-13/16" Long  
Ford & Mercury 1991-On  
UNIT PACKAGE: 10



**12610**  
(D2SB-65045A28-AA,  
N801829-S100)

Base Trim Panel Clip  
Panel Range .090-.110  
Escort, Lynx  
1981-On  
UNIT PACKAGE: 50

**20663**  
(F57Z-16241-AB,  
W709767-S300)  
Black Nylon

Rocker Panel  
Moulding Clip  
Head Size: 14mm x 40mm  
Stem Length: 11mm  
Ford Mustang  
2001 - On

UNIT PACKAGE: 15

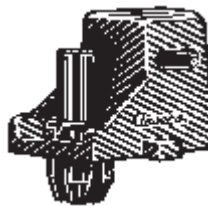
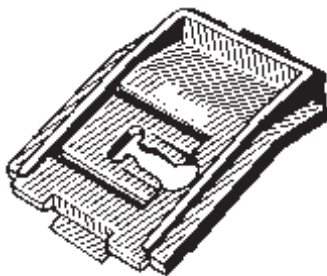

**18377**  
(W701430-S300)  
Black Nylon

Door Trim Retaining Clip  
Contour & Mystique  
1995-On  
UNIT PACKAGE: 10

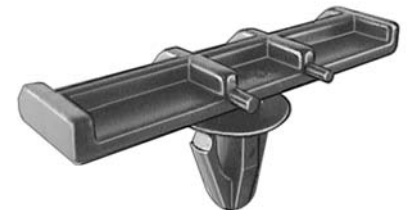

**14137**  
(D8BB-7420828-AA)  
Nylon

Moulding Clip  
Ford 1978-On  
UNIT PACKAGE: 25

**19441**  
(F1TZ-7810182-A)  
Black Nylon

Rocker Panel  
Ground Effects  
Moulding Clip  
Explorer,  
Expedition & F150  
1991-On

UNIT PACKAGE: 25

You Can E-mail  
Your New Item  
Suggestions To  
[mail@auveco.com](mailto:mail@auveco.com)

**FasTrack  
Auveco's Cost  
Recovery System  
For Repair Fasteners**

**Never Lose  
Money On Fasteners  
Again.**



**17602**  
(F1CZ-61101B04-A)  
Natural Nylon  
Body Side & Rocker Panel  
Moulding Clip  
Escort GT 1991-On  
UNIT PACKAGE: 15



**20355**  
(W705849-S300)  
Nylon  
Front End Moulding Clip  
Top Head Size: 1/2" x 13/16"  
Bottom Head Size:  
11/16" x 25/32"  
Stem Length: 3/8"  
Ford  
2000 - On  
UNIT PACKAGE: 10



**17667**  
Green Nylon  
Tubular Nut  
3/8" Hole Size  
Lower Body Side Moulding  
Lincoln Town Car  
1990-On  
UNIT PACKAGE: 25



**18822**  
(Ford: KA80-51-RF5A)  
Nylon  
Body Side Garnish  
Moulding Clip Mazda  
Millenia & Ford Probe  
1995-On  
UNIT PACKAGE: 15



**19345**  
(W702412-S300)  
Nylon  
Pillar Trim Clip  
Contour & Mystique  
1995-On  
UNIT PACKAGE: 50



**18882**  
(Ford: KA80-51-PR6;  
Mazda: EA01-50-048)  
Black Nylon  
Body Side Lower  
Wide Moulding Grommet  
Ford Probe & Mazda MX6  
1993-On  
UNIT PACKAGE: 10

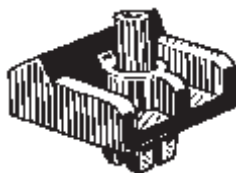

**18498**  
(W700614S300)  
Black Nylon  
Door Trim Clip  
Contour & Mystique  
1995-On  
UNIT PACKAGE: 10



**20392**  
Not Supplied By O.E.M.  
White Nylon  
Moulding Clip  
Head Diameter: 3/4"  
Stem Length: 15/32"  
Fits Into 5/16" Hole  
Ford Expedition, Explorer  
& Mountaineer  
2001 - On  
UNIT PACKAGE: 10



**19805**  
(W703507-S300)  
Natural Nylon  
Wheel Opening  
Moulding Clip  
Head Diameter: 18mm  
Stem Length: 8mm  
Focus  
2000 - On  
UNIT PACKAGE: 25





**20306**  
(W703505-S301)  
Zinc Organic

Wheel Opening  
Pushnut Retainer  
Retainer Diameter: 22mm  
**Used With Auveco  
Wheel Opening  
Moulding Clip 19805**  
Focus  
2000 - On

UNIT PACKAGE: 25

**Do You Have A  
Suggestion For Some  
New Items?  
E-mail Your  
Recommendations To  
mail@auveco.com**



**20194**  
(W701223-S300)  
Black Nylon

Cowl Grille Screw Cover  
13mm O.D.  
**Use With Auveco Fastener 20193**  
Contour, Focus & Mystique  
1995 - On

UNIT PACKAGE: 50



**20193**  
(W703842-S300,  
W703919-S300)  
Black Nylon  
w/ Zinc & Yellow Screw

Cowl Grille Fastener  
Nylon Retainer  
Length Under Head: 38mm  
**Replaces Auveco 18497**  
Contour, Focus & Mystique  
1995 - On

UNIT PACKAGE: 15



**14953**  
(N803494S)  
Black Nylon

Fascia, Trim & Grille  
Retainer  
Head Size: 15/32" x 15/32"  
Stem Length: 21/32"  
Fits Into 1/4" Square Hole or Slot  
Aerostar, Escort & Lynx  
1985-On

UNIT PACKAGE: 25

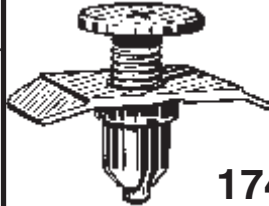

**17450**  
(Ford: E8BZ-17C756C,  
Mazda: BF67-50-235)  
Black Nylon

Bumper Cover Retainer  
Head Size: 20mm x 30mm  
Stem Length: 11mm  
Fits Into 10mm Hole  
Ford Festiva 1988-On  
Mazda 323 1986-On

UNIT PACKAGE: 10



**15366**  
(Ford: E7GZ-17A904-B;  
Mazda: BF67-50-033)  
Gray Nylon

Bumper Retainer  
Head Size: 20mm x 30mm  
Stem Length: 11mm  
Fits Into 10mm Hole  
Mercury Tracer 1987-On

UNIT PACKAGE: 10

**Inquire About Our  
FasTrack Cost  
Recovery Program For  
Body Shops**



**17060**  
(Ford: E92Z-17C756C;  
Mazda: GJ21-50-034)  
Black Nylon

Bumper Cover Retainer  
Head Size: 20mm x 30mm  
Stem Length: 20mm  
Fits Into 10mm Hole  
Ford Probe &  
Mazda MX6 1989-On

UNIT PACKAGE: 10



**14988**  
(N805229S)  
Black Nylon

Push-Type Retainer  
Head Diameter: 7/16"  
Stem Length: 11/16"  
Fits Into 15/64" Hole  
Ford 1987 - On

UNIT PACKAGE: 25



**14995**  
(GM: 10195515;  
Ford: N805026S;  
Chrys: 4696488, 6503163)  
Black Nylon

Push-Type Retainer  
Head Diameter: 1/2"  
Stem Length: 1-13/64"  
Fits Into 9/32" Hole  
GM, Ford & Chrysler  
1987 - On

UNIT PACKAGE: 25

**Sec. 20****FORD PRODUCTS CLIPS & FASTENERS****14992**(Ford: N803946S;  
Chrys: 6502871)  
Black NylonPush-Type Retainer  
Head Diameter: 19/32"  
Stem Length: 29/32"  
Fits Into 1/4" Hole  
Ford & Chrysler 1987 - On

UNIT PACKAGE: 50

**14991**(GM: 10139822; 25680782;  
Ford: N808147S)  
Black NylonPush-Type Retainer  
Head Diameter: 11/16"  
Stem Length: 11/16"  
Fits Into 1/4" Hole  
GM & Ford 1987 - On

UNIT PACKAGE: 25

**17632**(Mazda: B092-51-833;  
Ford: MB-455-56143)  
Black NylonPush-Type Retainer  
Head Diameter: 18mm  
Stem Length: 12mm  
Fits Into 8mm Hole  
Mazda & Ford Aspire

UNIT PACKAGE: 10

**18667**(F3XY-12044A59-C)  
Gray NylonRear Quarter  
Trim Panel  
Push-Type Retainer  
Head Diameter: 5/8"  
Stem Length: 29/32"  
Fits Into 1/4" Hole  
Mustang 1994-On

UNIT PACKAGE: 50

**18894**(N807578-S,  
N808332-S)  
Black NylonTrim Panel  
Push-Type Retainer  
Head Diameter: 11/16"  
Stem Length: 3/4"  
Fits Into 1/4" Hole

UNIT PACKAGE: 15

**20545**(N811283-S)  
Black Nylon &  
Santoprene RubberTrim Panel  
Push-Type Retainer  
Head Diameter: 18mm  
Stem Length: 18mm  
Fits Into 6.3mm Hole  
Ford Expedition & Navigator  
1997 - On

UNIT PACKAGE: 25

**20191**(YS4Z-16K262-AA)  
Black NylonPush-Type Retainer  
Head Diameter: 16mm  
Stem Length: 18mm  
Fits Into 6mm Hole  
Focus  
2000 - On

UNIT PACKAGE: 25

**14753**(GM: 20664092;  
Ford: N804570S)  
Black NylonTrim Retainer  
Head Dia: 11/16"  
Stem Length: 7/8"  
Fits Into 1/4" Hole  
Ford 1986-On

UNIT PACKAGE: 25

**20367**(W706713-S300)  
Black NylonBumper Cover  
Push-Type Retainer  
Head Diameter: 18mm  
Stem Length: 18mm  
Fits Into 8mm Hole  
Ford Escape  
2001- On

UNIT PACKAGE: 25

**18893**(N806322-S)  
Black NylonTrim Panel  
Push-Type Retainer  
Head Diameter: 11/16"  
Stem Length: 1/2"  
Fits Into 1/4" Hole

UNIT PACKAGE: 15

**18895**(N807577-S,  
N808331-S)  
Black NylonTrim Panel  
Push-Type Retainer  
Head Diameter: 11/16"  
Stem Length: 1-3/32"  
Fits Into 1/4" Hole  
Aerostar & Windstar

UNIT PACKAGE: 15

**19849**(Not Available  
From O.E.M.)  
Black Nylon & Santoprene RubberBumper Push-Type Retainer  
Head Diameter: 18mm  
Stem Length: 18mm  
Fits Into 8mm Hole  
Taurus & Sable  
2000 - On

UNIT PACKAGE: 25



**13469**  
(N802737-S)  
Black Nylon  
Under Hood Retainer  
Head Diameter 3/4"  
Stem Length 1/2"  
Fits Into 3/16" Hole  
Tempo & Topaz

UNIT PACKAGE: 25



**20310**  
(383142-S)  
Black Nylon  
Grille To  
Headlight Bracket  
Push-Type Retainer  
Head Diameter: 5/8"  
Stem Length: 7/16"  
Fits Into 1/4" Hole  
**Replaces Auveco 10214**  
Ford

UNIT PACKAGE: 50



**15522**  
(N805231S)  
Black Nylon  
Push-Type Retainer  
Head Diameter: 5/8"  
Stem Length: 17/32"  
Fits Into 1/4" Hole  
Taurus, Topaz & Sable  
1989-On

UNIT PACKAGE: 50



**16858**  
(Nissan: 63844-01A00;  
Ford: MNA01-56145,  
NA01-56145)  
Black Nylon  
Push-Type Retainer  
Head Dia: 20mm  
Stem Length: 18mm  
Fits Into 8mm Hole  
Nissan 1980-On  
Probe & Aspire 1995-On

UNIT PACKAGE: 25



**20273**  
(Ford: N808791;  
Chrys: 5GC71RC3AA,  
5GF92RC3AA)  
Gray Nylon  
Interior Trim, Dash & Console  
Push-Type Retainer  
Head Dia: 19mm  
Shoulder Length: 10mm  
Stem Length: 22mm  
Fits Into 9mm Hole  
Dodge Durango & Ford Pick-Ups  
1997 - On

UNIT PACKAGE: 25



**19607**  
(XL3Z-17E971-AA)  
Natural Nylon  
Front Bumper Cover  
Push-Type Retainer  
Head Dia.: 16mm  
Stem Length: 12mm  
Fits Into 10mm Hole  
F150 & F250 Trucks  
1999-On

UNIT PACKAGE: 25



**14994**  
(N804837S)  
Black Nylon  
Push-Type Retainer  
Head Diameter: 1"  
Stem Length: 29/32"  
Fits Into 1/4" Hole  
Ford 1987 - On

UNIT PACKAGE: 50



**20516**  
(W706182-S300)  
Black Nylon  
Headlight Mounting  
& Deck Lid  
Push-Type Retainer  
Head Diameter: 20mm  
10mm Hex  
Stem Length: 13mm  
Fits Into 8mm Hole  
Ford Expedition, Explorer & Focus  
2000 - On

UNIT PACKAGE: 25



**11702**  
(D6EA-1A100-AA)  
Natural Nylon  
Wheel Ornament  
Push-Type Retainer  
Head Diameter: 25/64"  
Stem Length: 19/32"  
Fits Into 9/32" Hole  
Ford 1976 - On

UNIT PACKAGE: 50



**11706**  
(387944-S)  
Black Nylon  
Grille To Metal  
Stamping Retainer  
Head Dia: 3/4"  
Shoulder Length: 1/4"  
Stem Length: 11/16"  
Fits Into 1/4" Wide Slot  
Ford Truck 1978-On

UNIT PACKAGE: 50

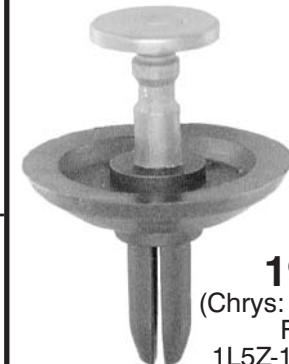

**19638**  
(Chrys: 4805405AA;  
Ford:  
1L5Z-17K826AA)  
Black & White Nylon  
Push-Type Retainer  
Head Dia.: 34mm  
Stem Length: 20mm  
Fits Into 8mm Hole  
Chrysler  
1998-On  
Ford Trucks  
2005 - On

UNIT PACKAGE: 15



**11705**  
(387843-S)  
Black Nylon  
Fender Shield Retainer  
Head Dia: 19/32"  
Stem Length: 5/8"  
Fits Into 1/4" Hole  
Ford 1978-On

UNIT PACKAGE: 50



**20233**  
(W705956-S300)  
Black Nylon  
Cowl Push-Type Retainer  
Head Diameter: 25mm  
Shoulder Diameter: 10mm  
Shoulder Length: 3mm  
Stem Length: 12mm  
Fits Into 9mm Hole  
Lincoln LS  
1999 - On

UNIT PACKAGE: 15

**Sec. 20****FORD PRODUCTS CLIPS & FASTENERS****18860**  
(N805017SW)  
Black NylonLuggage  
Compartment  
Trim Attachment  
Push-Type Retainer  
Head Diameter: 1"  
Stem Length: 9/16"  
Fits Into 1/4" Hole  
Taurus & Sable  
1991-86

UNIT PACKAGE: 15

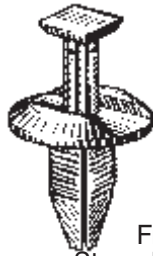
**16726**  
(N808048S,  
W705532-S300)  
Black NylonFront Bumper  
Stone Deflector Retainer  
Head Dia: 18mm  
Stem Length: 18mm  
Fits Into 6.3mm (1/4")  
Square Hole  
Bronco, Ranger  
& Explorer 1989-On

UNIT PACKAGE: 25

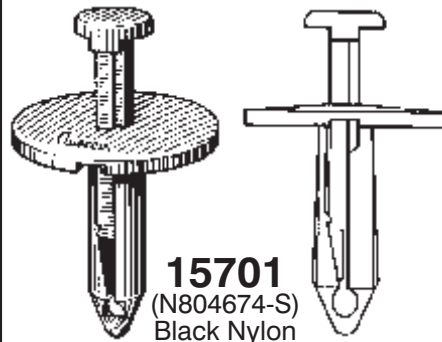
**15701**  
(N804674-S)  
Black NylonPush-Type Retainer  
Head Dia: 25mm  
Stem Length: 27mm  
Fits Into 7mm Hole  
Mustang & Capri

UNIT PACKAGE: 50

**17478**  
(Mazda: B101-68-252-00)  
Black NylonInterior Trim  
Push-Type Retainer  
Head Diameter: 14mm  
Stem Length: 16mm  
Fits Into 6mm Hole  
Ford Probe 1988-On  
Mazda MX6 1988-On

UNIT PACKAGE: 25

**14018**  
(N803716-S)  
Black NylonFascia Retainer  
Head Dia: 18mm  
Stem Length: 23mm  
Fits Into 7mm Hole  
Mustang/Capri  
1985-On

UNIT PACKAGE: 25

**19244**  
(N808847-S)  
Black NylonTrunk Trim Panel  
Push-Type Retainer  
Head Diameter: 1"  
Stem Length: 11/16"  
Fits Into 1/4" Square Hole  
Taurus & Sable  
1996-On

UNIT PACKAGE: 25

**17103**  
(GM: 15681408;  
Ford: N803709S)  
Black NylonFascia Attachment  
Push-Type Retainer  
Head Dia: 15mm  
Stem Length: 23mm  
Fits Into 6mm Hole  
GM & Ford 1986-On

UNIT PACKAGE: 50

**17216**  
(GM: 21030249;  
Ford: N807389S;  
Chry: 6503598)  
NylonAir Baffle To  
Under Carriage  
Push-Type Retainer  
Head Diameter: 20mm  
Stem Length: 20mm  
Fits Into 8mm Hole

UNIT PACKAGE: 25

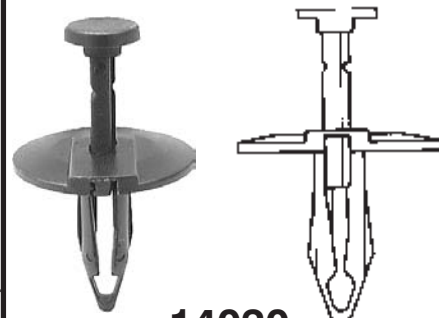
**14020**  
(Ford: N802781-S;  
GM: 14093088)  
Black NylonSplash Shield & Fascia Retainer  
Head Dia: 1"  
Stem Length: 7/8"  
Fits Into 1/4" Hole

UNIT PACKAGE: 25

**18206**  
(GJ21-68885-B69)  
Gray NylonPush-Type Retainer  
Head Diameter: 18mm  
Stem Length: 12mm  
Fits Into 6mm Hole  
Probe & Mazda MX6  
1989-On

UNIT PACKAGE: 25

**20632**  
(GM: 11518017,  
Ford: W708530-S300)  
Black NylonBumper Cover &  
Fender Shield  
Push-Type Retainer  
Head Diameter: 20mm  
Stem Length: 26mm  
Fits Into 8mm Hole  
GM & Ford  
1997 - On

UNIT PACKAGE: 15

**Please Order In  
Unit Package Quantity  
Not Pieces**

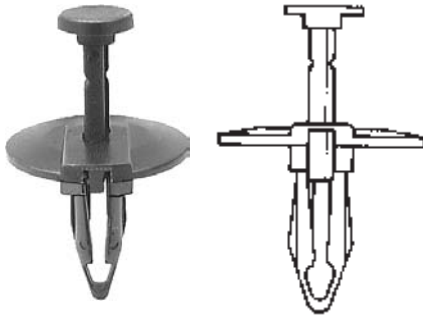

**14019**

(Ford: N803421-S,  
Chry: 6501590)  
Black Nylon

Splash Shield & Fascia Retainer  
Head Dia: 1"  
Shoulder Length: 1/8"  
Stem Length: 7/8"  
Fits Into 5/16" Hole  
UNIT PACKAGE: 25



**19337**

(N808908-S)  
Black Nylon

Headlight Accessory  
Push-Type Retainer  
Head Diameter: 14mm  
Stem Length: 23mm  
Fits Into 6.3mm (1/4") Hole  
Mustang  
1996 - On

UNIT PACKAGE: 10



**20363**

Not Available From O.E.M.  
White Nylon

Door Trim Panel  
Push-Type Retainer  
Top Head Diameter: 15mm  
Bottom Head Diameter: 20mm  
Overall Length: 32mm  
Fits Into 9mm Hole  
Ford 2001 - On

UNIT PACKAGE: 25

You Can E-Mail  
Your New Item  
Suggestions To  
[mail@auveco.com](mailto:mail@auveco.com)



**13994**

(GM: 20570245;  
Ford: N804614S)  
Black Nylon

Spare Tire Retainer  
Head Dia: 1"  
Stem Length: 7/8"  
Fits Into 5/16" Hole

UNIT PACKAGE: 25



**19511**

(W704958-S300)  
White Nylon

Rear Door  
Lower Trim Panel  
Push-Type Retainer  
Round Head Diameter: 19/32"  
Wedge Shaped Head  
Diameter: 29/32"  
Stem Length: 11/16"  
Fits Into 3/8" Hole  
Lincoln Town Car  
1998 - On

UNIT PACKAGE: 25



**20518**

(W705957-S300,  
W706519-S300)  
Black Nylon

Radiator Sight Shield  
Push-Type Retainer  
Head Diameter: 24.5mm  
Stem Length: 14mm  
Fits Into 9mm Hole  
Lincoln LS 2000 - On

UNIT PACKAGE: 10



**18503**

(W701054-S300)  
Black Nylon

Front Bumper  
Push-Type Retainer  
Head Diameter: 1"  
Stem Length: 1"  
Fits Into 5/16" Hole  
Contour & Mystique  
1995-On

UNIT PACKAGE: 25



**20169**

(W701971-S)  
White Nylon

Door Trim Panel  
Push-Type Retainer  
Head Diameter: 15mm  
Stem Length: 13mm  
Fits Into 7mm Hole  
Lincoln LS  
2000 - On

UNIT PACKAGE: 25



**19472**

(GM: 25535963;  
Ford: N811772S)  
Nylon

Upper Deflector Shield

UNIT PACKAGE: 25



**9426**  
(C7AB-14A163-B)

Horn Wire Retainer  
Tube Size 1/4"  
Ford

UNIT PACKAGE: 50



**18386**  
(W701133-S300)  
Black Nylon

Routing Clip  
Contour & Mystique  
1995-On

UNIT PACKAGE: 25

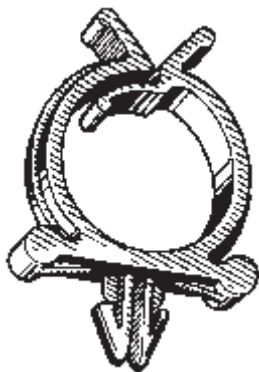

**14217**  
(GM: 1257702,  
20346654;  
Ford: 383207-S  
AMC: 3693099)

Nylon  
Routing Clip

UNIT PACKAGE: 25

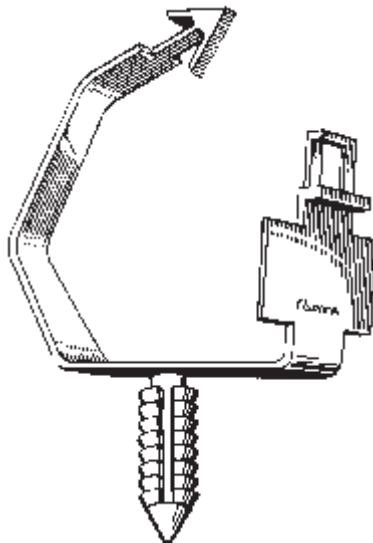

**12622**  
(D9AB-14A163JC)  
Nylon

Wire Routing Clip  
Stem: 5/16" x 3/4" Long  
Ford 1980-On

UNIT PACKAGE: 25



**12133**  
(EOVB-13A506-BA)  
Nylon

Clip Retainer  
Stem: 9/32" x 15/32" Long  
Ford 1979-On

UNIT PACKAGE: 50



**17164**  
(EOVY-13A506-A)  
Nylon

Rear Light  
Wiring Retainer  
3/8" Wide, 1-7/16" Long  
Stem: 9/32" x 7/16" Long  
Ford 1979-On

UNIT PACKAGE: 50



**20569**  
(E9DB-14A163CA,  
F1TZ-14A163E)  
Natural Nylon

Wiring Routing Clip  
Head Size: 10mm x 31mm  
Stem Diameter: 7mm  
Stem Length: 11mm  
Ford  
1989 - On

UNIT PACKAGE: 25

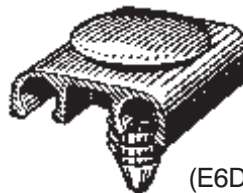

**15524**  
(E6DC-2B223AA,  
E9SC-2B223AA)  
Nylon

Clip Assembly  
For Brake Tube  
Length: 1"  
Holds 3/16" O.D. Tube  
Fits Into 1/4" Hole  
Cougar XR7 & T-Bird

UNIT PACKAGE: 10

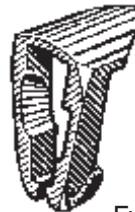

**17643**  
(N802239-S,  
N806191-S1901)  
Natural Nylon

Fuel Line Retainer Clip  
For 5/16" Fuel Line  
Ford (With Fuel Injection)  
1980-On

UNIT PACKAGE: 25



**20482**  
(2F1Z-9A317-AA)  
Natural Nylon

Fuel Line Retainer Clip  
For 5/16" Fuel Line  
Ford Taurus & Mercury Sable  
6 Cylinder 3.0 L Engine  
With Fuel Injection  
2002 - On

UNIT PACKAGE: 25

**Inquire About Our  
FasTrack Cost  
Recovery Program  
For Body Shops**



**20483**

(2F1Z-9A317-BA)  
Black Nylon

Fuel Line Retainer Clip  
For 3/8" Fuel Line  
Ford Taurus & Mercury Sable  
6 Cylinder 3.0 L Engine  
With Fuel Injection  
2002 - On

UNIT PACKAGE: 25



**18504**

(W702380-S300)  
Yellow Nylon

Hood Prop Rod Clip  
Fits 6mm Rod  
Contour & Mystique  
1995-On

UNIT PACKAGE: 5



**19536**

(F65Z-15020C34-AA)  
Black Nylon

Cowl Vent Plug  
Head Diameter: 21/32"  
Expedition & F150/250  
1996 - On

UNIT PACKAGE: 25



**17642**

(N802241-S,  
N806190-S1901)  
Black Nylon

Fuel Line Retainer Clip  
For 3/8" Fuel Line  
Ford (With Fuel Injection)  
1980-On

UNIT PACKAGE: 25

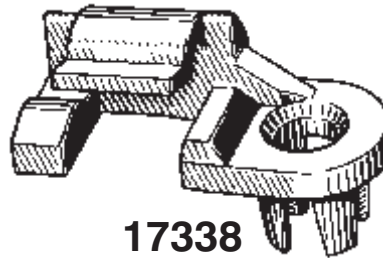

**17338**

(D5ZZ-16828A)  
Nylon

Hood Prop Rod Clip  
7/32" Rod Diameter  
Ford/Mercury Bobcat, Cougar,  
Fairmont, Granada, Monarch,  
Mustang, Pinto, Thunderbird, Zephyr  
& E100/350 1991-75

UNIT PACKAGE: 15



**10837**

(D3AA-90826-AA)  
Nylon

Speed Control Rod to  
Throttle Pivot  
Ford

UNIT PACKAGE: 10



**16954**

(386299-S)  
Nylon

Hood Prop Rod Clip  
5/16" Rod Diameter  
Ford Cars 1975-On

UNIT PACKAGE: 25

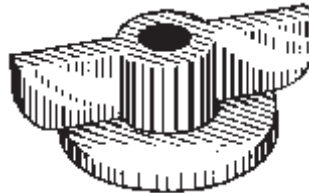

**13472**

(Ford: 386285,  
AMC: 3230375)  
Nylon

Air Cleaner Wing Nut  
Self Threading  
1/4", 6mm  
Ford and AMC

UNIT PACKAGE: 10

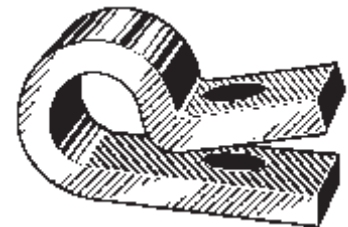

**18387**

(91GBA611A08BEAW)  
Nylon

Headrest Clamp  
Contour & Mystique  
1995-On

UNIT PACKAGE: 10

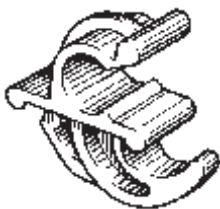

**16992**

(E83Z-16828A)  
Nylon

Hood Prop  
Rod Clip  
5/16" Rod Diameter  
Ford 1988-On

UNIT PACKAGE: 10

Please Order  
In Unit Package  
Quantity Not Pieces



**18102**

(Ford: N806624-S191;  
Chry: 6502776)

Rear Light Assembly  
Retainer  
Ford Explorer  
1991-On

UNIT PACKAGE: 25



**19823**

(N806511-S32)

Phosphate & Olive Drab

Parking Light Retainer Nut  
Screw Size: #8 (M4.2 - 1.41)  
Ford Vans  
1997 - On

UNIT PACKAGE: 25



**20546**

(N808342-S307)  
Black Phosphate

Air Cabin Filter Fastener  
Size: 5/8" x 25/32"  
Ford Taurus & Sable  
1995 - On

UNIT PACKAGE: 50



**17613**

(N802190-S53)  
Phosphate

Wheel Ornament Retainer Nut  
M4.2-1.81 (#8) Screw Size  
Aerostar, Bronco II, Explorer &  
Ranger  
1983-On

UNIT PACKAGE: 100



**19677**

(N804741-S2)

Black Phosphate

Instrument Panel Fastener  
Use With 5/16"  
Tapping Screw  
Head Size: 9/16" x 5/8"  
Overall Length: 1"  
LTD, Mercury  
Marquis & Trucks  
1996 - On

UNIT PACKAGE: 10



**12610**

(D2SB-65045A28-AA)  
N801829-S100)

Base Trim Panel Clip  
Panel Range .090-.110  
Escort, Lynx  
1981 - On

UNIT PACKAGE: 50



**14820**

(N803685S)

Dash Panel Nut  
Screw Size: #8 (M4.2-1.41)  
Taurus/Sable

UNIT PACKAGE: 25



**12606**

(E1EB-61046A48-BA)

Lower Finish Panel Clip  
Ford 1981-On

UNIT PACKAGE: 25



**14819**

(N803968-S100)

Bumper Strip Retainer  
25/32" Long, 9/32" Wide  
Taurus/Sable

UNIT PACKAGE: 50



**14979**

Dashboard/Instrument  
Panel Nut  
#8-18 Thread  
Top is 13/32" x 3/8"  
Ford 1986-On

UNIT PACKAGE: 50

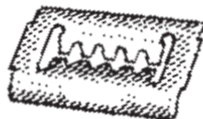

**17003**

Not Supplied By OEM

Bumper Cover Retainer  
Front & Rear Bumpers  
Ford Festiva 1988-On

UNIT PACKAGE: 50



**19838**

Not Available From O.E.M.  
Dacromet 320

Front Bumper  
Chrome Strip Fastener  
Size: 5/8" x 1"  
Flange Size: 7/32" x 1"  
Grip Range: .039" - .098"  
(1mm - 2.5mm)  
Ford Explorer  
1999 - On

UNIT PACKAGE: 10





**18879**  
(N807455-S100)  
Black Phosphate  
Radiator Grille Fastener  
Explorer 1995-On  
UNIT PACKAGE: 25



**20396**  
Zinc & Yellow  
1/4" - 20 Specialty Insert  
Grip: .030" - .165"  
Head Diameter: 1/2"  
Hex Size: 3/8"  
**Can be set with  
Auveco Tool 11805**  
UNIT PACKAGE: 15



**20401**  
(W706172-S309,  
W708384-S309)  
Zinc & Yellow  
M6-1.0 Specialty Insert With Sealer  
Grip: .5mm-4.2mm  
Head Diameter: 13mm  
Hex Size: 9.5mm  
Roof Rack  
Ford Escape, Excursion, Expedition,  
Explorer, Navigator & Mountaineer  
2000 - On  
**Can be set with  
Auveco Tool 11805**  
UNIT PACKAGE: 15

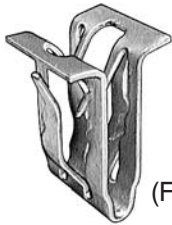

**19421**  
(F7UZ-1513284-BA)  
Zinc Organic  
Front Door Scuff  
Plate Retainer  
Econoline Van  
E150/350  
1997-On  
UNIT PACKAGE: 25



**20421**  
(N811257-S100)  
Zinc & Olive Drab  
M5-.8 Specialty Insert With Sealer  
Grip: .5mm-2.5mm,  
Head Diameter: 10mm,  
Hex Size: 7mm  
General Purpose  
Ford Escape, Excursion, Expedition,  
Explorer, Navigator & Mountaineer  
2001 - On  
**Can be set with  
Auveco Tool 11805**  
UNIT PACKAGE: 15



**20415**  
(GM: 15685099;  
Ford: N803763-S100)  
Zinc & Yellow  
M6-1.0 Specialty Insert With Sealer  
Grip: .65mm - 2.0mm  
Head Diameter: 12mm  
Hex Size: 8mm  
Roof Rack, Tailgate  
& General Purpose  
GM APV Vans, C & K Trucks  
And Ford Explorer  
1991 - On  
**Can be set with  
Auveco Tool 11805**  
UNIT PACKAGE: 15

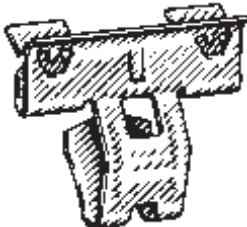

**17063**  
(N806537)  
Black Zinc  
Scuff Plate  
Moulding Fastener  
Tempo & Topaz 1989-On  
UNIT PACKAGE: 15



**20678**  
Zinc & Yellow  
M5- .8 Specialty Insert  
Grip: .5mm-3.3mm  
Head Diameter: 10mm  
Hex Size: 7mm  
**Can be set with  
Auveco Tool 11805**  
UNIT PACKAGE: 15



**19436**  
(N808182-S309)  
Zinc & Yellow  
Roof Rack  
Mounting Nut Insert  
M6 - 1.0 Thread  
Grip: .7mm - 3.17mm  
Head Diameter: 13mm  
Explorer & Expedition  
1997-On  
**Can Be Set With  
Auveco Tool 11805**  
UNIT PACKAGE: 10

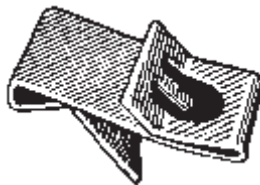

**14895**  
(Ford: N803638-S36B)  
Top Vent Grille (Water Deflector)  
Mounting Clip  
Escort & Lynx 1984-On  
UNIT PACKAGE: 25

**Sec. 20**

**FORD PRODUCTS CLIPS & FASTENERS**

Not Actual Size

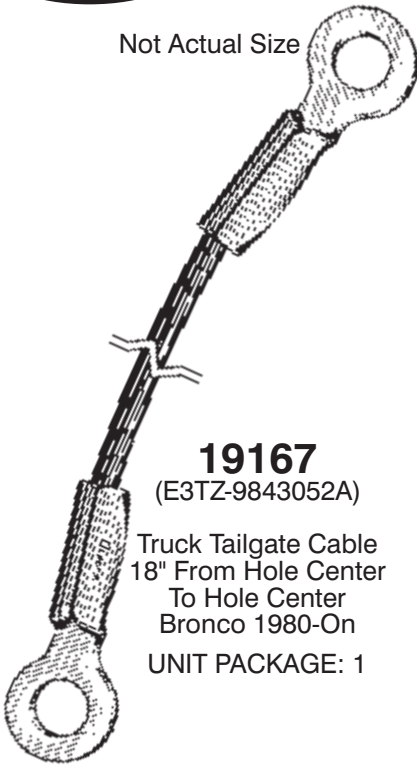

**19167**  
(E3TZ-9843052A)

Truck Tailgate Cable  
18" From Hole Center  
To Hole Center  
Bronco 1980-On  
UNIT PACKAGE: 1



**20153**

White Door Lock Pawl  
Right-Hand Side  
Ford Continental, Contour,  
Explorer, Mountaineer,  
Mystique, Ranger, Sable  
& Taurus And Mazda Truck  
1996 - On

UNIT PACKAGE: 1



**20195**

Pink Door Lock Pawl  
Left-Hand Side  
Ford Continental, Contour,  
Explorer, Mountaineer,  
Mystique, Ranger, Sable  
& Taurus And Mazda Truck  
1996 - On

UNIT PACKAGE: 1



**17118**  
(E6DZ-5421971-A,  
F3LY-6321971A)  
Nylon

Door Lock Pawl  
Left-Hand Side  
Ford Taurus & Sable 1986-On

UNIT PACKAGE: 10



**17119**  
(E6DZ-5421970-A,  
F3LY-6321970-A)  
Nylon

Door Lock Pawl  
Right-Hand Side  
Ford Taurus & Sable 1986-On

UNIT PACKAGE: 10

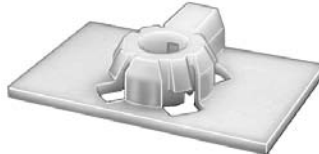

**20630**  
(F8DZ-54265A99-AA)  
White Nylon

Door Latch Guide  
Width: 23mm  
Length: 36mm  
Taurus & Sable  
1998 - On

UNIT PACKAGE: 15



**14967**  
(GM: 9815325,  
16607593)  
Ford: D2VZ-6521952A)  
Nylon

Door Lock Rod Clip  
Fits 5/32" Rod  
GM 1971-On  
Ford: 1972-On

UNIT PACKAGE: 50

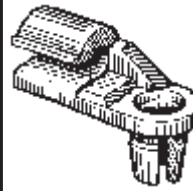

**15675**  
(E6AZ-5421952-A,  
390523S)  
Yellow Nylon

Door Lock Rod Clip  
5/32" Rod Size  
Ford Products 1986-On

UNIT PACKAGE: 25

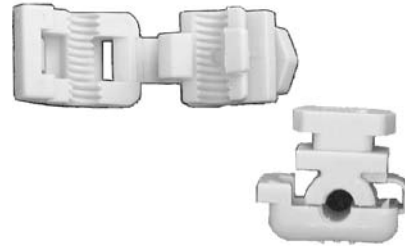

**19651**  
Yellow Nylon  
(F85Z-1521952-BB)

Door Lock Rod Clip  
Expedition & Navigator  
F150, 250  
1997 - On

UNIT PACKAGE: 10

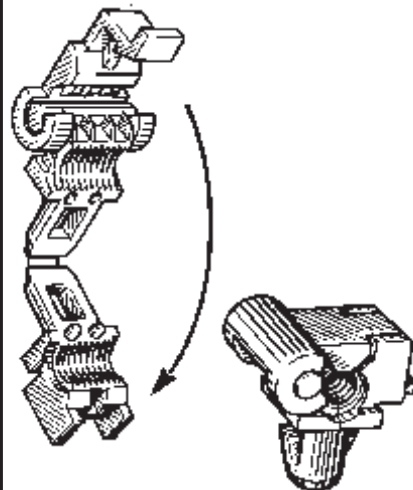

**17122**  
(E6DZ-5421952A,  
E83Z-5421952B)  
Nylon

Door Lock Rod End Clip  
Taurus, Sable, Tempo, Topaz, T-Bird  
& Cougar, Aerostar, Bronco,  
Explorer, Mountaineer, Pick-Up,  
Ranger & Windstar  
1986-On

UNIT PACKAGE: 10



**18914**  
Not Supplied  
By O.E.M.  
PVC Plastic

Door Lock Striker Bushing  
1/2" I.D., 1 1/16" O.D.  
7/8" Long  
Ford 1972-On  
UNIT PACKAGE: 50

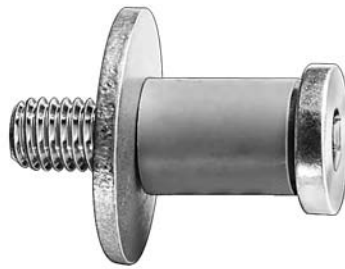

**18892**  
(D2AZ-6522008-A)

Door Lock Striker  
Bolt Assembly  
7/16"-14 Thread  
Cars 1980-73  
E100/350 Vans  
(Back Door) 1986-80  
UNIT PACKAGE: 1



Not Actual Size

**19594**  
(D9ZZ-6643030-AA)  
Zinc Plated

Door Hinge Pin  
Pin Diameter: 11/32"  
Length Under Head: 3-3/8"  
Head Diameter: 9/16"  
Mustang 1993 - 79  
Tempo & Topaz 1994 - 90  
Capri 1986 - 80

UNIT PACKAGE: 10



**18890**  
(E9AZ-5422008A)

Door Lock Striker  
Bolt Assembly  
M10-1.50 Thread  
Ford, Mercury & Mustang  
1991-83  
Truck E100/300 & F100/350  
1980-On  
UNIT PACKAGE: 1

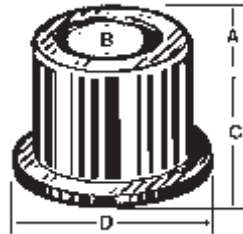

## Door Hinge Bushings

Auveco Part No.	Dimensions			
	O.D. "A"	I.D. "B"	Height "C"	Flange O.D. "D"
14550	27/64"	11/32"	19/64"	19/32"
14551	31/64"	11/32"	19/64"	19/32"



**18891**  
(E9FZ-5822008-A)

Door Lock Striker Bolt Assembly  
7/16-14 Thread  
Tempo, Topaz, Escort, Tracer,  
Taurus, Sable, T-Bird, Cougar,  
Lincoln, Aerostar, Bronco II,  
Explorer & Ranger  
1983-On  
UNIT PACKAGE: 1



**14550**  
(D1AZ-6522841A)  
Ford 1973-On  
UNIT PACKAGE: 25



**14551**  
(D90Z-6522841A)  
Ford 1973-On  
UNIT PACKAGE: 25



**20346**  
Not Available  
From O.E.M.  
Zinc & Yellow

Door Hinge Pin  
Length: 3-1/2"  
Pin Dia: 11/32"  
Knurl Dia: .358"  
Head O.D.: 9/16"  
**Use With Auveco 8829  
E-Type Retaining Ring**  
Ranger, F150,  
F250 & F350  
1998 - 80

UNIT PACKAGE: 5

**Truck Door Hinge Spring**

**14555**

Right (Passenger's) Side  
5-3/4" Long

UNIT PACKAGE: 2

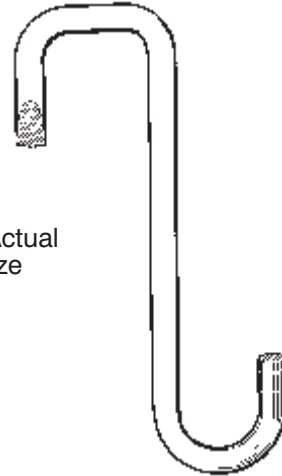

Not Actual  
Size

Now you don't have to replace the entire door hinge assembly on Ford trucks when only the spring is broken. You eliminate removing, replacing and realigning the door.

This OEM equivalent spring has been redesigned to make installation easier. The whole procedure is now this easy:

1. Remove the original spring.
2. Place the new spring into the upper slots of the hinge.
3. Use a wrench to twist and drive the spring into place. You may need a light hammer to tap the spring into the lower slots.



**13030**

(E2GZ-6723342A)  
Black Nylon

Window Crank Handle

UNIT PACKAGE: 1



**12470**

(D1FZ-6222600-A,  
D2FZ-6222600-A)

Door Handle

UNIT PACKAGE: 1



**19426**

(F2SZ-14570-A)  
Zinc Organic

Window Regulator  
Housing Retainer  
Right-Hand & Left-Hand Side  
Cougar, Mark Series,  
Mustang & Thunderbird  
1991-On

UNIT PACKAGE: 25



**13032**  
Black

Window Crank  
Handle Knob  
Ford 1974-On

UNIT PACKAGE: 2



**13035**  
Clear

Window Crank  
Handle Knob  
Ford 1969-On

UNIT PACKAGE: 2

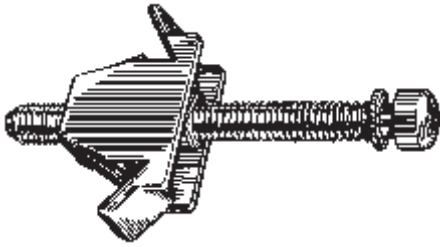

**11848**  
(4270581, 4334140,1,2,  
5201359)

#12-28 x 2-1/2"  
Headlight  
Adjusting  
Screw & Nut  
Assembly  
Torx Drive  
Chrysler 1978-On  
UNIT PACKAGE: 10

**11849**  
Same as 11848 Except Packing  
UNIT PACKAGE: 100

Please Order In Unit  
Package Quantities  
Not Number Of Pieces

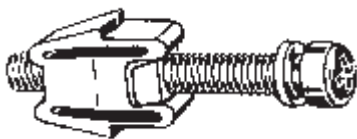

**11653**  
(3574085)  
Gray Nylon

#12-28 x 1-1/2"  
Headlight  
Adjusting Screw  
& Nut Assembly  
Chrysler 1976-On  
UNIT PACKAGE: 25

**11654**  
Same as 11653 Except Packing  
UNIT PACKAGE: 100

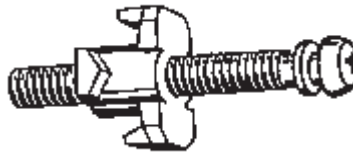

**11371**  
(3691599)

#12-28 x 1-1/2"  
Headlight  
Adjusting Screw  
& Nut Assembly  
Chrysler 1975-On

UNIT PACKAGE: 10



**10760**

#12-28 x 1-1/2"  
Headlight  
Adjusting Screw  
& Nut Assembly  
Chrysler 1972-On

UNIT PACKAGE: 10

**10761**  
Same as 10760 Except Packing  
UNIT PACKAGE: 100



**16995**  
(6033376)  
Black

Headlight Adjuster  
Retainer  
Chrysler Acclaim,  
LeBaron, Saratoga  
& Spirit 1990-On

UNIT PACKAGE: 25



**16583**  
(2524526)  
Black Nylon

Headlight  
To Front Fender  
Mounting Plate Nut  
#8 or #10 Screw Size  
Chrysler

UNIT PACKAGE: 25



**16581**  
(152863)  
Natural Nylon

Rear Window Garnish  
Moulding Nut  
#8 Screw Size  
Chrysler 1978-On

UNIT PACKAGE: 50



**11832**  
(0152867)  
Natural Nylon

Headlight Spacer Nut  
#8 Screw Size  
Chrysler 1978-On

UNIT PACKAGE: 25



**8419**

(2524525)  
Natural Nylon

Headlight Bezel Nut  
#8 or #10 Screw Size  
Chrysler

UNIT PACKAGE: 50



**13466**

(6032516)  
Black Nylon

License Plate Nut  
#12 Screw Size  
Chrysler

UNIT PACKAGE: 25



**14800**

(6500725)  
Black Nylon

Headlight Bezel Nut  
#10 Screw Size  
Chrysler 1983-On

UNIT PACKAGE: 50



**9377**

(Chry: 6000943;  
AMC: 8934-201-263)  
White Nylon

Radiator Grille Nut  
#8 Screw Size  
Chrysler & AMC-Renault

UNIT PACKAGE: 100



**12735**

(GM: 1370853;  
Chry: 6029501;  
VW: 179-813-883)  
Natural Nylon

Headlight Bezel Nut  
#6 Screw Size  
GM & VW 1982-On

UNIT PACKAGE: 50



**19485**

(6027958)  
Natural Nylon

License Plate Nut  
& Door Lock  
Remote Control  
Switch Bracket Nut  
#14 (1/4") Screw Size  
Fits Into 3/8" x 3/8" Hole  
Chrysler 1984-On

UNIT PACKAGE: 10



**12569**

(Ford: N801706-S;  
Chry: 6501773)  
Black Nylon

#12 Screw Size

UNIT PACKAGE: 25



**18034**

(6503108)  
Black Nylon w/Cushion

Luggage Compartment Trim  
Nylon Nut  
#8 Screw Size

Chrysler Concorde & LHS,  
Dodge Intrepid & Eagle Vision  
1993-On

UNIT PACKAGE: 25



**14756**

(Chry: 6033677;  
Ford: 379830-S)  
Black Nylon

3/8" Wide, 3/8" Long  
Fits Into 9/32" x 9/32" Hole  
Panel Thickness: 1/4"

#8 Screw Size  
Chrysler & Ford 1986-On

UNIT PACKAGE: 25



**19785**

(4805119)  
Natural Nylon

Cowl Vent Nylon Nut  
#10 (M4.8) Screw Size  
LH, Neon & 300M  
1998 - On

UNIT PACKAGE: 25



**19640**

(6505161AA)  
White Nylon

Bumper Fascia Grommet  
Screw Size: M4.2 (#8)  
Head Dia.: 14mm x 18mm  
Snaps Into a 9mm x 11mm Hole  
LH & LHS Series  
1998-On

UNIT PACKAGE: 25



**13647**

(6031234)  
White Nylon

Radiator Grille Nut  
#8 Screw Size  
Chrysler

UNIT PACKAGE: 25



**20179**

(6035401)  
Green Nylon

Door Trim Panel  
Nylon Nut  
M4.2 (#8) Screw Size  
Head Size: 16mm x 16mm  
Stem Length: 10mm  
Caravan, Town & Country  
and Voyager  
1996 - On

UNIT PACKAGE: 25

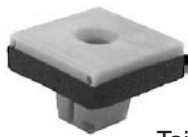

**20267**  
(6505703AA)  
Tan Nylon

Tail Light  
Nylon Nut  
Head Size: 5/8" x 5/8"  
Stem Length: 3/8"  
#8 (M4.2) Screw Size  
Jeep Grand Cherokee  
2000 - On

UNIT PACKAGE: 15



**12566**  
(Chry: 6032061;  
GM: 25508532)  
Black Nylon

Grille  
Attachment Grommet  
Chrysler & GM 1981-On

UNIT PACKAGE: 25



**20524**  
(6035821)  
Black Nylon

Door Panel & Fender Shield  
Screw Grommet  
#8 Screw Size  
Head Size: 1/2" x 21/32"  
Stem Length: 7/16"  
Dodge Vans, Durango & Sebring  
1996 - On

UNIT PACKAGE: 25



**14218**  
(6031183)  
Black Nylon

#6 or #8 Screw Size  
Chrysler

UNIT PACKAGE: 50



**12713**  
(Chry: 6031869;  
GM: 1264963;  
AMC: 8934-201-602)  
Natural Nylon

High Torque Screw Grommet  
Chrysler, GM & AMC-Renault

UNIT PACKAGE: 25



**17354**  
(6501699)  
Black Nylon

Cowl Screen Nut  
#8 Screw Size  
Chrysler Mini-Vans & Cars  
1990-On

UNIT PACKAGE: 25



**11720**  
White Nylon

Grille Nut  
#8 or #10 Screw Size  
Chrysler 1976-On

UNIT PACKAGE: 50



**19276**  
(34201872,  
8934-201-872)  
Natural Nylon

Door Trim Panel  
& Cowl Grille Seal  
Screw Grommet  
#4 or #6 Screw Size  
Jeep Cherokee, Grand Cherokee,  
Comanche & Grand Wagoneer  
1991-On

UNIT PACKAGE: 25



**18825**  
(6503373)  
Black Nylon

Cowl & Dash Panel  
Screw Grommet  
#8 Screw Size  
Cirrus & Stratus  
1995-On

UNIT PACKAGE: 15



**20275**  
Not Supplied  
By O.E.M.  
White Nylon

Door Panel Grommet  
Head Dia: 19mm  
Stem Length: 12mm  
Fits Into 9mm Hole

**Use With Auveco 20274**  
LH Series  
2000 - On

UNIT PACKAGE; 25



**19793**  
(6504072)  
Black Nylon

Tail Light Housing Grommet  
Head Diameter: 16mm  
Stem Length: 10mm  
Snaps Into 12mm Hole  
Dakota & Ram Trucks  
1997 - On

UNIT PACKAGE: 25



**14037**  
(GM: 15596280;  
Chry: 6035274)  
Black Nylon

Cowl Vent Nut  
#6 or #8 Screw Size

UNIT PACKAGE: 25



**20667**  
(4860375-AB)  
White Nylon

Cowl Vent Grommet  
M4.8 (#10) Screw Size  
Head Size: 14mm x 20mm  
Caravan, Town & Country  
And Voyager Mini-Vans  
2004 - On

UNIT PACKAGE: 50



**20468**  
(6506852-AA)  
Green Nylon

Trim Panel Grommet  
Head Dia.: 17mm  
Stem Length: 12mm  
Fits Into 8mm Hole  
**Use with Auveco 20467**  
Sebring & Stratus 2001 - On

UNIT PACKAGE: 50



**19642**  
(4805336AA)  
White Nylon

Bumper Fascia Grommet  
Head Dia.: 10mm x 15mm  
Snaps Into 9mm x 12mm Hole  
Concorde, Intrepid  
& Eagle  
1998-On

UNIT PACKAGE: 25



**20356**  
(4759514AB)  
Black Rubber

Rubber Grommet  
Head Diameter: 15mm  
Stem Length: 11mm  
Fits Into 9mm Hole  
Floor Pan Plug &  
Luggage Compartment Carpet  
LH, LHS & Concorde  
1997 - On

UNIT PACKAGE: 50



**17195**  
(Isuzu: 8942180270)  
Black Nylon

Grille Clip  
13mm Wide  
22mm Long  
Ford Escort, Honda, Isuzu,  
Mitsubishi & Plymouth Laser

UNIT PACKAGE: 25



**20525**  
Not Available  
From O.E.M.  
Black Nylon

Headlight Mounting  
Panel Grommet  
Head Size: 16mm x 22mm  
Stem Length: 20mm  
Jeep Grand Cherokee  
1999 - On

UNIT PACKAGE: 25



**20581**  
(MR478263)  
Black Rubber

Bumper Cover &  
Garnish Moulding Grommet  
With Sealer  
Head Diameter: 16mm  
Stem Length: 20mm  
Fits Into 9mm Hole  
**Use With Auveco 20580**  
Sebring & Stratus  
And Mitsubishi Eclipse  
2000 - On

UNIT PACKAGE: 15

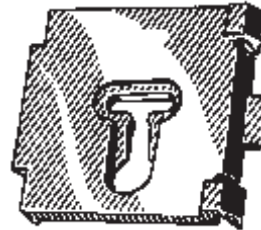

**13843**  
(6003861)  
Nylon

Deck Lid  
Moulding Clip  
Chrysler 1984-On

UNIT PACKAGE: 25



**20565**  
(MB271999)  
Black Nylon

Bumper Cover Grommet  
Head Diameter: 24mm  
Stem Length: 21mm  
Fits Into 13mm Hole  
Colt, Eagle, Sebring  
& Stratus 1989 - On  
Mitsubishi Eclipse, Galant  
& Mirage 1993 - On

UNIT PACKAGE: 10

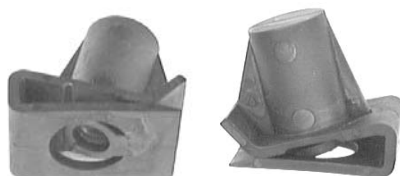

**19809**  
(6504870AA)  
Natural Nylon

Nylon "U" Nut  
M4.2 (#8) Screw Size  
Panel Range: 1mm - 4.25mm  
Center Of Hole To Edge: 10mm  
LH & 300M  
1998 - On

UNIT PACKAGE: 25



**12794**  
(6003609)  
Nylon

Roof Side Moulding Clip  
Chrysler 1977-On

UNIT PACKAGE: 50

**Please Order  
In Unit Package  
Quantity  
Not Pieces**



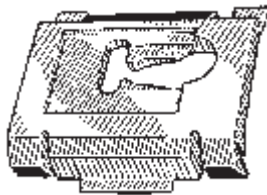

**13927**  
(6003774,  
6003965)  
Nylon

Body Side Moulding Clip  
Chrysler 1981-On

UNIT PACKAGE: 25

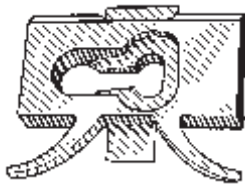

**13616**  
(6003219)  
Nylon

Moulding Clip  
Chrysler 1971-On

UNIT PACKAGE: 25

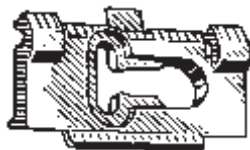

**13847**  
(6003858)  
Nylon

Deck Lid Moulding Clip  
Chrysler Vans 1984-On

UNIT PACKAGE: 25



**12913**  
(6003647)  
Nylon  
Quarter Outside Belt  
Moulding Clip  
Chrysler 1977-On

UNIT PACKAGE: 25

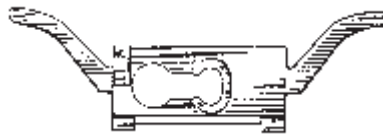

**11936**  
(6003632)  
Nylon

Wheel Opening Moulding Clip  
Chrysler 1978-On

UNIT PACKAGE: 50

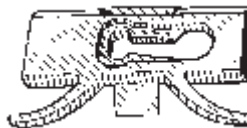

**13615**  
(6003575)  
Nylon

Wheel Opening  
Moulding Clip  
Chrysler  
1975-On

UNIT PACKAGE: 25



**11354**  
(6003147)  
Nylon

Moulding Clip  
Chrysler 1976-On

UNIT PACKAGE: 25



**17064**  
(6004162)  
Nylon

Woodgrain Side  
Moulding Clip  
Dodge Caravan &  
Plymouth Voyager  
Mini-Vans 1990-On

UNIT PACKAGE: 25



**13845**  
(6003873)  
Nylon

Body Side & Back Door  
Moulding Clip  
Chrysler Vans 1984-On

UNIT PACKAGE: 50



**17151**  
(6004036)  
Nylon

Window Reveal Moulding Clip  
Chrysler LeBaron & Maserati  
1987-On

UNIT PACKAGE: 15



**19814**  
(MB567798)  
Black Nylon

Door Moulding Clip  
Head Size: 12mm x 14mm  
Stem Length: 11mm  
Fits Into 8mm Hole  
Sebring  
1999 - On

UNIT PACKAGE: 15



**19894**  
(5FR56DX9)  
Black Nylon

Rocker Panel Clip  
Head Size: 7/16" x 25/32"  
Stem Length: 5/8"  
Jeep Grand Cherokee  
1999 - On

UNIT PACKAGE: 25



**20523**  
(55156429-AA)  
Black Nylon

Rocker Panel &  
Bumper Fascia Clip  
Top Head Size:  
1/2" x 1-316"  
Stem Length: 27/32"  
Jeep Liberty  
2002 - On

UNIT PACKAGE: 10

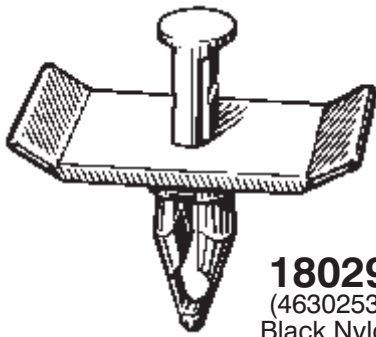

**18029**  
(4630253)  
Black Nylon

Rear Fascia  
Push-Type Retainer  
Head Size: 7/8" x 1-25/32"  
Stem Length: 1-1/16"  
Fits Into 1/2" Hole  
Chrysler Concorde & LHS  
Dodge Intrepid & Eagle Vision  
1993-On

UNIT PACKAGE: 15



**19131**

Not Available From O.E.M.  
Black Nylon

Cowl Screen Retainer  
Chrysler New Yorker, Intrepid,  
LHS, Concorde & Eagle Vision  
1993-On

UNIT PACKAGE: 15



**18032**  
(6502573)  
Black Nylon

Cowl Screen  
Attachment  
Push-Type Retainer  
Head Size: 15/32"  
Stem Length: 9/16"  
Fits Into 1/4" Square Hole  
Chrysler Concorde & LHS,  
Dodge Intrepid & Eagle Vision  
1993-On

UNIT PACKAGE: 15



**19266**  
(6501852)  
Black Nylon

Cowl Screen  
Push-Type Retainer  
Head Diameter: 15/32"  
Stem Length: 1-1/8"  
Fits Into 1/4" Square Hole  
Acclaim, LeBaron  
& Spirit  
1995-94

UNIT PACKAGE: 15



**14995**

(GM: 10195515;  
Ford: N805026S;  
Chrys: 4696488, 6503163)  
Black Nylon

Push-Type Retainer  
Head Diameter: 1/2"  
Stem Length: 1-13/64"  
Fits Into 9/32" Hole  
Ford, GM & Chrysler  
1987 - On

UNIT PACKAGE: 25



**14992**

(Ford: N803946S;  
Chrys: 6502871)  
Black Nylon

Push-Type Retainer  
Head Diameter: 19/32"  
Stem Length: 29/32"  
Fits Into 1/4" Hole  
Ford & Chrysler 1987 - On

UNIT PACKAGE: 50



**15672**  
(8880417)  
Black Nylon

Push-Type Retainer  
Head Diameter: 17mm  
Stem Length: 14mm  
Fits Into 8mm (5/16") Hole  
Chrysler 1987-On

UNIT PACKAGE: 25



**19140**

(Acura:  
90505-SL0-003;  
GM: 94852368;  
Mitsubishi:  
MB888869; Toyota:  
90467-08155)  
Black Nylon

Push-Type Retainer  
Head Diameter: 20mm  
Stem Length: 21mm  
Fits Into 8mm Hole  
Acura, Dodge Avenger,  
Eagle Talon, Geo Prizm,  
Mitsubishi Eclipse & Galant  
and Toyota  
1993-On

UNIT PACKAGE: 5

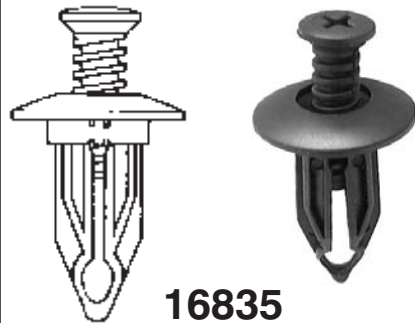

**16835**

(GM: 10140480;  
Chry: 6502625)  
Black Nylon

Push-Type Retainer  
Head Dia: 21mm (27/32")  
Shoulder Length: 3mm (1/8")  
Stem Length: 25mm (1")  
Fits Into 12mm (1/2") Hole

UNIT PACKAGE: 25

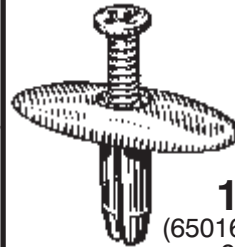

**17104**

(6501630,6501772,  
6501878)  
Black Nylon

Headlight & Tail Light  
Panel Attachment  
Push-Type Retainer  
Head Size: 15mm x 31mm  
Stem Length: 17mm  
Fits Into 5mm x 6.5mm Hole  
Dodge Daytona 1987-On

UNIT PACKAGE: 10



**11704**  
(6031383)  
Black Nylon

Grille Retainer  
Head Diameter: 11/16"  
Stem Length: 7/16"  
Fits Into 9/32" Hole  
Chrysler 1978-On

UNIT PACKAGE: 25

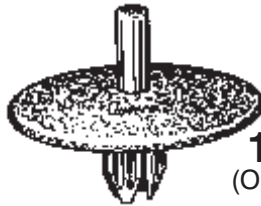

**17080**  
(OH452KD5)  
Nylon  
Quartz  
Matte Finish

Headliner Retainer  
Head Dia: 1-1/4"  
Stem Length: 7/16"  
Fits Into 1/4" Hole  
Dodge Caravan &  
Plymouth Voyager 1984-On

UNIT PACKAGE: 15



**14016**  
(GM: 16500308;  
Chry: 6500787)  
Black Nylon

Tail Light Retainer  
Large Head Diameter: 3/8"  
Stem Length: 7/16"  
Fits Into 3/16" Hole  
GM & Chrysler

UNIT PACKAGE: 25



**11699**  
(GM: 472434;  
Chry: 6031390)  
Black Nylon

Cowl Ledge  
Weatherstrip & Fender Liner  
Push-Type Retainer  
Head Dia: 11/16"  
Stem Length: 5/8"  
Fits Into 1/4" Hole  
GM 1970-On  
Chrysler 1968-On

UNIT PACKAGE: 50



**12567**  
(GM: 14019205,  
14019206;  
Chry: 34201621)  
Black Nylon

Front Fender Mud Skirt  
& Fender Liner  
Push-Type Retainer  
Head Dia: 11/16"  
Stem Length: 9/16"  
Fits Into 1/4" Hole  
GM 1981 - On

UNIT PACKAGE: 25



**20580**  
(MR478262)  
Black Nylon

Bumper Cover &  
Garnish Moulding  
Push-Type Retainer  
Top Head Diameter: 15mm  
Bottom Head Diameter: 14mm  
Stem Length: 12mm  
Fits Into 7mm Hole  
**Use With Auveco 20581**  
Sebring & Stratus  
And Mitsubishi Eclipse  
2000 - On

UNIT PACKAGE: 15

**Please Order In Unit  
Package Quantities  
Not Number Of  
Pieces**

**14007**

Same as 12567 except packing

UNIT PACKAGE: 50



**20273**  
(Ford: N808791;  
Chrys: 5GC71RC3AA,  
5GF92RC3AA)  
Gray Nylon

Interior Trim, Dash & Console  
Push-Type Retainer  
Head Dia: 19mm  
Shoulder Dia: 10mm  
Shoulder Length: 7mm  
Stem Length: 22mm  
Fits Into 9mm Hole  
Dodge Durango &  
Ford Pick-Ups  
1997 - On

UNIT PACKAGE: 25



**18327**  
(6503454)  
Black Nylon

Front Bumper Fascia  
Push-Type Retainer  
Head Diameter: 11/16"  
Stem Length: 5/8"  
Fits Into 1/4" Hole  
Jeep Grand Cherokee  
1994-On

UNIT PACKAGE: 25

**Do You Want Your  
Customers To Know  
You Use The Best  
Body Hardware &  
Specialty Fasteners  
Available?**

**Promotional Products  
And Apparel Bearing  
The  Logo  
Promote Your Identity  
As A Professional.**



**14961**  
(4248294,  
F155EK1)  
Tan Nylon

Interior Trim  
Push-Type Retainer  
Large Head Diameter: 13mm  
Stem Length: 7mm (Exc. the pin)  
Fits Into 7mm Square Hole  
Chrysler 1987 - On

UNIT PACKAGE: 25

**14963**  
(4248294,  
F155DT3)

Light Palomino Nylon

Same as 14961 except color

UNIT PACKAGE: 25

**14965**  
(4248294,  
F155GL7)

Taupe (Brownish-Gray)

Same as 14961 except color

UNIT PACKAGE: 25

**14966**  
(4248294,  
F155GR8)  
Burgundy

Same as 14961 except color

UNIT PACKAGE: 25

**You Can E-mail Your  
New Item  
Suggestions To  
mail@auveco.com**



**18030**  
(Chry: 6501925;  
GM: 10134407)  
Black Nylon

Push-Type Retainer  
Head Size: 11/16"  
Stem Length: 13/16"  
Fits Into 1/4" Hole  
Chrysler Concorde & LHS  
Dodge Intrepid & Eagle Vision  
1993-On  
Coolant Recovery Reservoir  
GM 1992-On

UNIT PACKAGE: 25



**13993**  
(GM: 20510029;  
Chry: 34202672)  
Black Nylon

Body Retainer  
Head Dia: 11/16"  
Stem Length: 7/8"  
Fits Into 1/4" Hole  
GM 1984-On

UNIT PACKAGE: 25

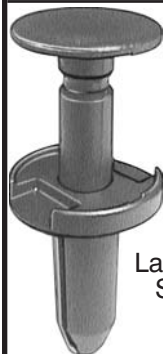

**19422**  
(6504521)  
Black Nylon

Fascia  
Push-Type Retainer  
Large Head Dia.: 23/32"  
Stem Length: 29/32"  
Fits Into 5/16" Hole  
LHS, Concorde,  
Intrepid & Eagle Vision  
1998-On

UNIT PACKAGE: 25



**19245**  
(5BB14LX9)  
Black Nylon

Fascia To Front Bumper  
Push-Type Retainer  
Large Head Dia.: 3/4"  
Stem Length: 1-1/8"  
Fits Into 1/4" Hole  
Dodge Dakota  
1994-On

UNIT PACKAGE: 25



**20458**  
(6506132-AA)  
Black Nylon

Side Radiator Shield  
Push-Type Retainer  
Head Dia.: 20mm  
Stem Length: 17mm  
Fits Into 7mm Hole  
Sebring & Stratus  
2001 - On

UNIT PACKAGE: 25



**17216**  
(GM: 21030249;  
Ford: N807389S;  
Chry: 6503598)  
Black Nylon

Air Baffle To  
Under Carriage  
Push-Type Retainer  
Head Diameter: 20mm  
Stem Length: 20mm  
Fits Into 8mm Hole

UNIT PACKAGE: 25



**20457**  
(4857345-AA)  
Black Nylon

Tail Light Housing  
Push-Type Retainer  
Large Head  
Dia.: 21mm  
Stem Length: 23mm  
Fits Into 9.5mm Hole  
Caravan  
Town & Country And  
Voyager Mini Vans  
2002 - On

UNIT PACKAGE: 25



**18269**  
(6503106)  
Black Nylon

Lower Sill  
Moulding  
Push-Type Retainer  
Large Head Dia.: 7/8"  
Stem Length: 1"  
Fits Into 1/4" Hole  
Jeep Grand Cherokee  
Laredo 1994-On

UNIT PACKAGE: 15

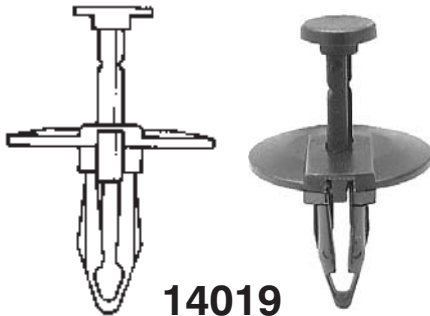

**14019**

(Ford: N803421-S;  
Chry: 6501590)  
Black Nylon

Push-Type Retainer  
Head Dia: 1"  
Shoulder Length: 1/8"  
Stem Length: 7/8"  
Fits Into 5/16" Hole  
UNIT PACKAGE: 25



**18394**

(6503453)  
Black Nylon

Fascia To Bumper  
Push-Type Retainer  
Large Head Dia.: 1"  
Stem Length: 1-1/8"  
Fits Into 1/4" Hole  
Jeep Grand Cherokee  
1994 - On

UNIT PACKAGE: 25



**19638**

(Chrys:  
4805405AA;  
Ford:  
1L5Z-17K826AA)  
Black & White  
Nylon

Front Bumper Fascia  
Push-Type Retainer  
Head Dia.: 34mm  
Stem Length: 20mm  
Fits Into 8mm Hole  
Concorde, Intrepid, Eagle  
Pacifica & PT Cruiser  
1998-On  
Ford Trucks  
2005-On

UNIT PACKAGE: 15



**18237**

(6502545)  
Nylon

Headlight Side  
Shield Retainer  
Dodge Daytona  
1992-On

UNIT PACKAGE: 25

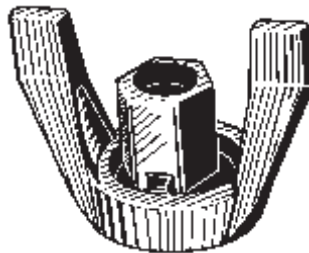

**13465**

(4275973)  
Nylon

Air Cleaner  
Wing Nut  
1/4"-20  
Chrysler

UNIT PACKAGE: 10

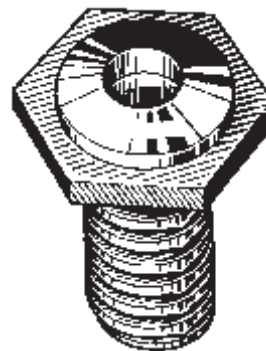

**14216**

(4103165)  
Nylon

Hood Bumper  
Across The Flats: 28mm  
Diameter: 18mm  
Overall Length: 47mm  
Chrysler 1981-On

UNIT PACKAGE: 10

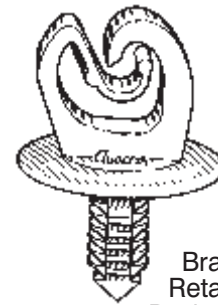

**18267**  
(3200040)  
White Nylon

Brake Line  
Retainer Clip  
Dodge Van With  
Anti-Lock Brakes  
1994-On

UNIT PACKAGE: 10



**14985**

(2664040)  
White Nylon

Door Weatherstrip to  
Inside Panel Clip  
Chrysler Corp. 1966-On

UNIT PACKAGE: 100



**18035**

(6503274)  
Black Nylon

Insulation Retainer  
Head Diameter: 1-3/16"  
Stem Length: 1/2"  
Fits On 3/16" Dia. Stud  
Chrysler

UNIT PACKAGE: 25



**18249**

(6503339)  
Black Nylon

Cowl Top Stud Retainer Cover  
Head Diameter: 13/16"  
Dodge Ram 1994-On

UNIT PACKAGE: 25

**Sec. 20****CHRYSLER PRODUCTS CLIPS & FASTENERS****20623**(Chrysler: 6506306-AA)  
Black NylonCowl Screen Retainer  
Head Diameter: 25mm  
T-30 Torx® Drive  
Stem Length: 14mm  
Fits On To 1/4" - 20 Bolt  
Dodge Dakota  
1997 - On

UNIT PACKAGE: 15

**20312**(GM: 15021761;  
Chry: 5027550AB)  
Yellow NylonHood Prop Rod Clip  
7mm Rod Diameter  
Snaps Into 10mm Hole  
GM Cars & Trucks  
Chrysler PT Cruiser  
Isuzu Hombre  
1990 - On

UNIT PACKAGE: 10

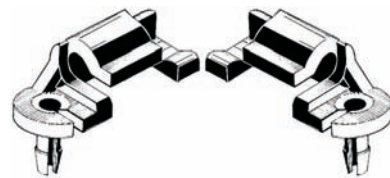

Right-Hand Side    Left-Hand Side

**10262**(AMC: 4003672R,  
4003673L,  
Chrys: 2945108R,  
2945109L, 4658676)  
NylonDoor Lock Rod & Hood  
Latch Locking Push Rod Clip  
Rod Size: 5/32"  
Fits Into 1/4" Hole  
Chrysler & AMCUNIT PACKAGE: 20 Pieces  
10 Rights - 10 Lefts**19792**(6505319AA)  
Black NylonTorx® Drive  
Cowl Screen Retainer  
Head Diameter: 27/32"  
Stem Length: 1-3/8"  
T30 Drive  
Jeep Grand Cherokee  
1999 - On

UNIT PACKAGE: 25

**20419**(J4007456)  
Black NylonHood Prop Rod Clip  
5/16" Rod Diameter  
Overall Length: 1-3/8"  
Mini-Vans  
1997 - On

UNIT PACKAGE: 10

**20675**

White Nylon

Clip For Right-Hand Side Only

UNIT PACKAGE: 25

**20420**(6505863-AA)  
Black NylonWire Routing Clip  
Holds 3/16" (5mm) Diameter Wire  
Stem Diameter: 5/16"  
Stem Length: 9/32"  
Flange Diameter: 25/32"  
Mini-Vans  
2002 - On

UNIT PACKAGE: 15

**15673**(3454220,  
4658676)  
Red NylonDoor Lock Rod Clip  
Used On Right-Hand Side  
Rod Size: 5/32"  
Chrysler 1972 - On

UNIT PACKAGE: 50

**14697**

Black Nylon

Clip For Left-Hand Side Only

UNIT PACKAGE: 50

**20307**Not Supplied  
By O.E.M.  
Black NylonSliding Door Lock Rod Clip  
Used On Left-Hand Side  
Rod Size: 5mm  
Fits Into 7mm Hole  
Full-Size Vans  
1997 - On

UNIT PACKAGE: 10

**14858**

(3799089)

Windshield Wiper Linkage Bushing  
Replaces worn wiper  
linkage bushing  
thus eliminating wiper lag  
Chrysler 1974-On

UNIT PACKAGE: 25

**15674**(3454221,  
4658677)  
Green NylonDoor Lock Rod Clip  
Used On  
Left-Hand Side  
Rod Size: 5/32"  
Chrysler 1972 - On

UNIT PACKAGE: 50



**20308**

Not Supplied  
By O.E.M.  
Black Nylon

Sliding Door Lock Rod Clip  
Used On Right-Hand Side  
Rod Size: 5mm  
Fits Into 7mm Hole  
Full-Size Vans  
1997 - On

UNIT PACKAGE: 10



**19191**

(4658444)  
Lavender Nylon

Door Lock Rod Clip  
Right-Hand Side  
Rod Size: 1/8"  
Chrys. Neon, Cirrus,  
Stratus & Jeep Cherokee  
1995-On

UNIT PACKAGE: 25



**19190**

(4658445)  
Orange Nylon

Door Lock Rod Clip  
Left-Hand Side  
Rod Size: 1/8"  
Chrysler Neon, Cirrus,  
Stratus & Jeep Cherokee  
1995-On

UNIT PACKAGE: 25



**10215**

(6026686)  
Phosphate

Air Deflector Hex Washer  
Head Nut  
1/4"-20 Thread; 1/2" Hex  
3/4" Washer O.D.  
Chrysler

UNIT PACKAGE: 25



**20317**

(6505049AA)  
Zinc

Fender Moulding  
Push Nut Retainer  
Stud Size: 5mm  
24mm O.D.  
Jeep Cherokee  
1997 - On

UNIT PACKAGE: 50



**10080**

(6027924)

Radiator Grille  
Panel Upper  
Support Baffle Retainer  
Chrysler

UNIT PACKAGE: 100



**19152**

(6031875)

Grille Bar Clip  
Chrysler 1981-On

UNIT PACKAGE: 50



**19784**

(6036042AA)  
Zinc Organic

Door Window  
Moulding Nut  
M4.2 (#8) Screw Size  
LH & LHS  
1998 - On

UNIT PACKAGE: 25



**19310**

(6034336, 6034812,  
6035807)  
Phosphate

Door Panel Nut  
#6 Screw Size  
Cirrus,  
Concorde,  
Intrepid, LHS,  
Stratus &  
Eagle Vision  
1993-On

UNIT PACKAGE: 25



**19339**

(4676356)  
Phosphate

Grille To Fascia Fastener  
Town & Country,  
Caravan and Voyager  
1997-On

UNIT PACKAGE: 15



**20526**

(4805570-AA)  
Black

Radiator Grille  
Cover Fastener  
26mm Wide, 26mm Long  
Caravan, Town & Country  
And Voyager Mini-Vans  
1996 - On

UNIT PACKAGE: 10



**19794**  
(6503174)  
Phosphate

Cowl, Pillar &  
Door Panel Fastener  
Width: 7/16"  
Length: 19/32"  
Mini-Vans  
& Jeep Cherokee  
1996 - On  
UNIT PACKAGE: 25



**18102**

(Ford: N806624-S191;  
Chry: 6502776)

Rear Light Assembly Retainer  
UNIT PACKAGE: 25



**20173**  
(6506104AA)  
Zinc & Yellow

Roof Rack Nutsert  
With Sealer Under Head  
M6-1.0 Thread  
Grip: .7mm - 3.2mm  
Head Diameter: 17mm  
9.5mm (3/8") Hex  
**Can Be Set With  
Auveco Tool 11805**  
Jeep  
1999 - On

UNIT PACKAGE: 10



**16729**  
(4198993)

Door Window Opening  
Moulding Clip  
Dodge & Plymouth  
Daytona,  
Pacific, Shelby & Laser  
1984-On  
UNIT PACKAGE: 50



**19779**

(6503812, 6504601)  
Zinc & Yellow

Wheel Opening Moulding Nutsert  
M5 - .8 Thread  
Head Diameter: 10mm  
**Can Be Set With  
Auveco 11805 Tool**  
Overall Length: 12mm  
Jeep  
1999 - On  
UNIT PACKAGE: 15

Please Order In  
Unit Package Quantity  
Not Pieces

## Dodge Truck Door Hinge Bolt & Bushing Repair Kit

*For 2003 – 1994 Dodge Ram 1500, 2500 & 3500 Pick-Up Trucks*



Why bother with the hassle of cutting and grinding off a worn door hinge and welding on a new one when you can repair the bad hinge in a fraction of the time?

With our Door Hinge Bolt & Bushing Repair Kit, fixing sagging doors caused by worn hinges due to pin or bushing failure is quick. It's easy. It works. And you don't have to paint the welded heat flash area.

Each kit is designed to repair one hinge and contains one zinc and yellow dichromate plated grade 8 bolt, two self-lubricating brass alloy bushings, one zinc plated spin lock nut and one zinc plated internal lock washer.

Here's how easy it is:

1. Remove the door from the truck body.
2. Grind or cut off the end of the pin at the peaned end.
3. Remove the old pin and bushings.
4. Install the bushings into the hinge holes.
5. Place the washer on the bolt and install the bolt into the bushings.
6. Thread the nut onto the bolt and tighten.
7. Reattach the door to the truck body.

**20544**

Door Hinge  
Bolt & Bushing  
Repair Kit

UNIT PACKAGE: 1 Kit

Detailed instructions are included with the kit.







**14562**  
(6028993,  
6032975)

Door Hinge Pin  
Length: 2-3/4"  
Pin Dia: 17/64"  
Head O.D.: 9/16"  
Cargo doors,  
lift gates, rear doors  
and fold-up rear  
seat floor hinges  
on Dodge &  
Plymouth vans,  
Ramcharger  
and Trailduster  
1970-On

UNIT PACKAGE: 10



**14561**  
(6500361)  
Zinc

Door Hinge Pin  
Length: 2-1/4"  
Pin Dia: 1/4"  
Chrysler  
1980-On

UNIT PACKAGE: 10



**17167**  
(4336115)

Door Hinge Bushing  
Front & Rear Doors  
Aries, Caravelle, LeBaron, Reliant,  
Town & Country and 600  
1989-85  
O.D.: 3/8"  
I.D.: 1/4"  
Length: 13/32"  
Flange O.D.: 1/2"

UNIT PACKAGE: 25



**17434**  
(2486468)

Door Hinge Bushing  
Chrysler Vans  
1982-78  
O.D.: 27/64"  
I.D.: 11/32"  
Length: 7/16"  
Flange O.D.: 19/32"

UNIT PACKAGE: 25



**14552**  
(4033711)

Door Hinge Bushing  
Cargo doors, lift gates,  
rear doors and fold-up rear seat  
floor hinges on Dodge &  
Plymouth vans, Ramcharger  
and Trailduster  
1970-On  
O.D.: 5/16"  
I.D.: 17/64"  
Length: 23/64"  
Flange O.D.: 33/64"

UNIT PACKAGE: 25



**14195**

Window Crank  
Handle Knob  
Chrysler 1977-70

UNIT PACKAGE: 1

The Auveco FC-1 Flip Chart  
Is A Great Selling Tool.

Use It To Help Boost Your Sales.  
Refer To The Color Pages  
At The Front Of The Book.

**Sec. 20**

**AMC CLIPS & FASTENERS**

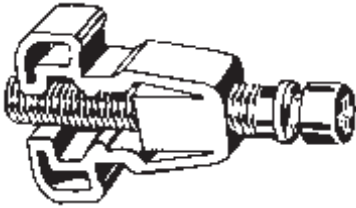

**11470**

(AMC: SF 400 6204;  
GM: 1606642,  
1618890)  
1/4"-28 x 1-7/8"  
Headlight Adjusting Screw & Nut  
AMC & Cadillac  
1975-On

UNIT PACKAGE: 25

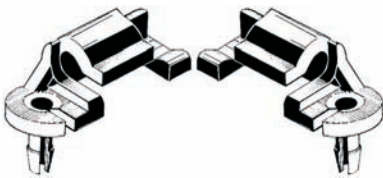

Right-Hand Side    Left-Hand Side

**10262**

(AMC: 4003672R,  
4003673L;  
Chrys: 2945108R,  
2945109L, 4658676)  
Nylon

Door Lock Rod & Hood  
Latch Locking Push Rod Clip  
Rod Size: 5/32"  
Fits Into 1/4" Hole  
AMC & Chrysler

UNIT PACKAGE (20) Pieces  
10 Rights - 10 Lefts)

**20675**

White Nylon

Clip For Right-Hand Side Only

UNIT PACKAGE: 25

**14697**

Black Nylon

Clip For Left-Hand Side Only

UNIT PACKAGE: 50



**13036**

Black

Window Crank  
Handle Knob  
AMC

UNIT PACKAGE: 2



**11697**

(4000141)  
Nylon

#6 or #8 Screw Size  
AMC

UNIT PACKAGE: 50



**2272**

(3426388)

Front Fender and Door  
Quarter Panel Moulding  
Fastener:  
Rambler

UNIT PACKAGE: 100

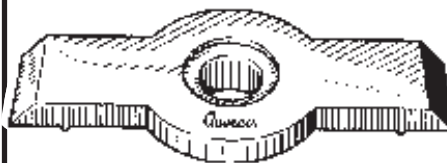

**15813**

(4005714)  
Nylon

Window Glass Retainer  
AMC Eagle 1988-On

UNIT PACKAGE: 25

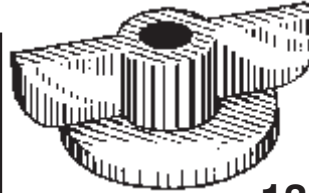

**13472**

(Ford 386285;  
AMC 3230375)  
Nylon

Air Cleaner Wing Nut  
Self-Threading  
1/4", 6mm  
AMC & Ford

UNIT PACKAGE: 10

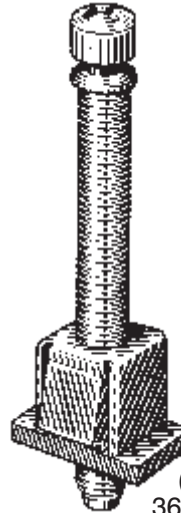

**15666**

(AMC: 36000148,  
36001966, 56001419;  
VW: 176 941 1117A)

1/4"-28 x 2-1/4"  
Headlight Adjusting Screw  
and Nut Assembly  
AMC Encore &  
Alliance 1983-On  
VW

UNIT PACKAGE: 10

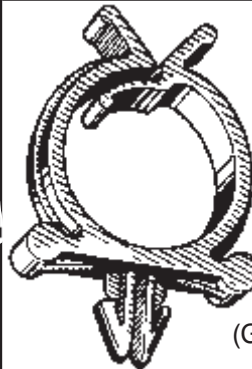

**14217**

(GM: 1257702,  
20346654;  
Ford: 383207-S;  
AMC: 3693099)  
Nylon

Routing Clip  
GM / Ford / AMC

UNIT PACKAGE: 25

# CHRYSLER KEY BLANKS

## Sec. 21



Groove  
61  
Y-152

**19952**  
(B & S 320514)  
1984-70  
U.P. 25



Groove  
61

**19953**  
(B & S 320515)  
Fleet  
U.P. 5

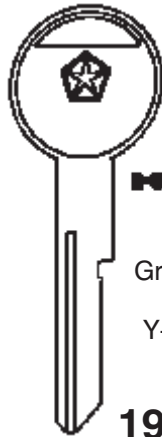

Groove  
53  
Y-149

**19947**  
(B & S 320433)  
1990-70  
U.P. 25



Groove  
60  
RA4

**19970**  
(B & S 321074)  
Ram Charger  
1990-81  
U.P. 5



Y-153  
Groove  
61

**20024**  
(B & S 593578)  
1989-84  
U.P. 10

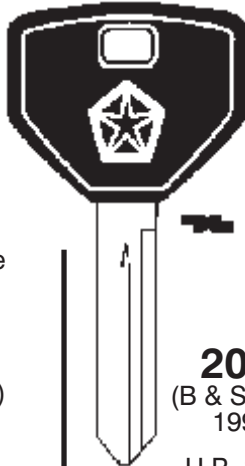

Groove  
73  
Y-154

**20030**  
(B & S 594145)  
1992-89  
U.P. 10

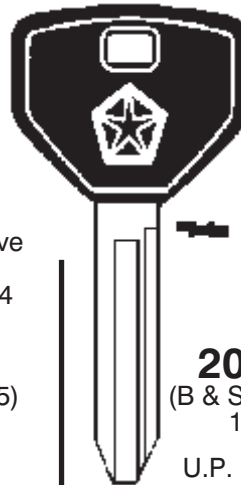

Groove  
78  
Y-155

**20035**  
(B & S 595895)  
1993  
U.P. 10

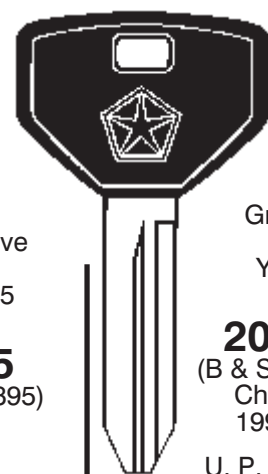

Groove  
84  
Y-157

**20110**  
(B & S 596504)  
Chrysler  
1996-94  
U.P. 10

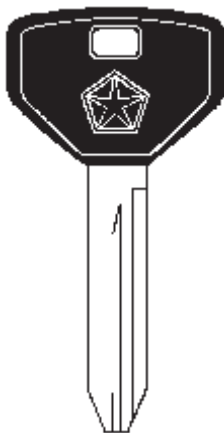

Groove  
85

**20121**  
(B & S 597158)  
Molded Neon Yellow  
Chrysler Neon  
1996-95  
U.P. 10



Groove  
84

**20148**  
(B&S 597176;  
Chry: 4796386)  
Primary Key  
Dodge Dakota, Van &  
Ram Pick Up  
1997-94  
Caravan & Voyager  
1995-94  
U.P. 10



Groove  
84  
10 Cut

**20155**  
(Chrys: 5013809-AA)  
(B & S 599013)  
Chrysler Key Blank  
One Key System  
Jeep Grand Cherokee  
1999 - On  
U.P. 1



Groove  
84

**20152**  
(B&S: 596508;  
Chry: 4746316)  
Jeep Cherokee  
1997  
U.P. 10

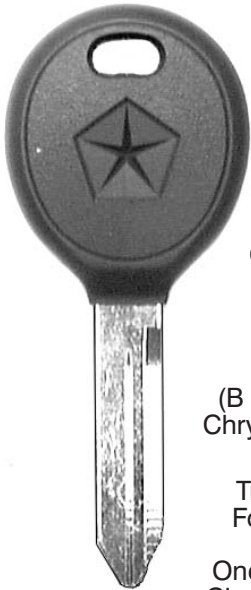

Groove 84  
8 Cut

**19791**

(B & S: 598495;  
Chry: 5010366AA)

Internal  
Transponder  
For Anti-Theft  
Security  
One Key System  
Cirrus, Concorde,  
New Yorker, Intrepid,  
Sebring & Vision  
1999 - On

UNIT PACKAGE: 1



Groove  
84

Y-159

**20139**

(B & S 597121)  
Primary Key Blank  
Chrysler Mini-Van  
1996-On

UNIT PACKAGE: 10



YMOS  
RN32

**20000**

(B & S 321802)  
Primary  
Jeep & Dodge Monaco

UNIT PACKAGE: 10

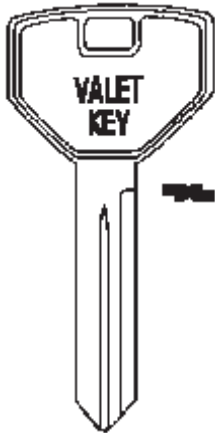

Groove  
73

**19981**

(B & S 321566)

1992-89

UNIT PACKAGE: 10

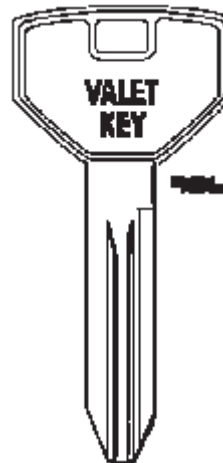

Groove  
79  
Y-156

**20013**

(B & S 322140)

1993-On

UNIT PACKAGE: 5

**Remember...  
All Items In This Catalog Are Available In Bulk.**

**Call For A Quote.**

**CHRYSLER KEY BLANKS (Continued)**

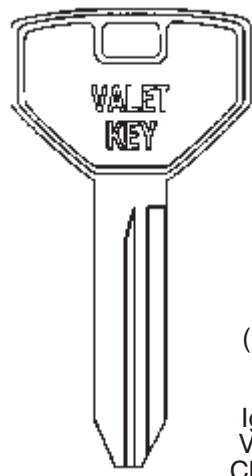

Groove  
85  
Code  
Series L  
Y-158

**20090**  
(B & S 322235,  
322236)

Ignition & Door  
Valet Key Blank  
Chrysler 1996-94

UNIT PACKAGE: 10

Chrysler Key Blank Chart	
Groove	Application
61 53	1990-69
60	Ram Charger
73	1992-1989
78 79	1993

**Larger Quantities Available**

**FORD KEY BLANKS**



Groove  
40

**19930**  
(B & S 32838)  
1964-52

UNIT PACKAGE: 10



Groove  
49  
H51

**19973**  
(B & S 321207)  
1988-65

UNIT PACKAGE: 25

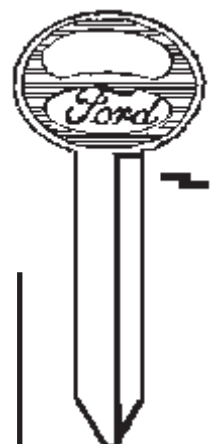

Groove  
48  
H50

**19972**  
B & S 321202)  
1988-65

UNIT PACKAGE: 25



8 Cut  
Groove 82  
H75F

**20122**  
(B & S 597638)  
Primary & Secondary  
Key Blank  
Taurus & Explorer  
1996  
F-Series, Bronco  
& Ranger 1997 - On

UNIT PACKAGE: 10

Visit The Auveco Web Site At [www.auveco.com](http://www.auveco.com) For The Latest Information On New Items.

# Sec. 21

## FORD KEY BLANKS (Continued)

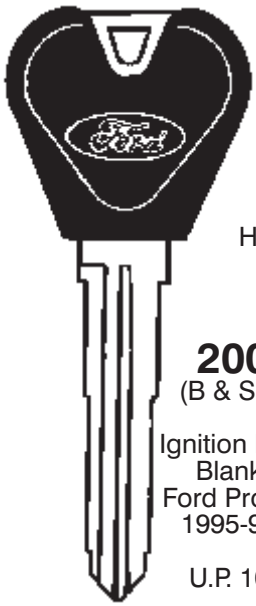

H65

**20091**  
(B & S 596756)

Ignition Key  
Blank  
Ford Probe  
1995-94

U.P. 10



Groove  
49  
H54  
H60  
10  
Cut

**19984**  
(B & S 321645)

1984-On  
U.P. 15



10 Cut

H60  
H67

**20092**  
(B & S 596758)

Ignition  
Key Blank  
Ford 1995-93

U.P. 10



Groove  
49

10 Cut  
H55

**19985**  
(B & S 321648)

1984-On

U.P. 15

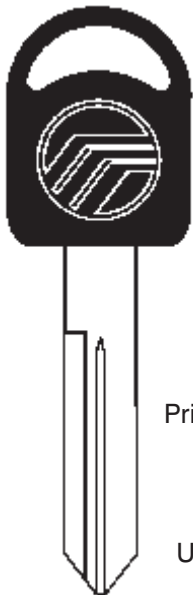

Groove  
82  
H75P

**20123**  
(B & S 597037)

Primary & Secondary  
Key Blank  
Mercury Sable  
1996

UNIT PACKAGE: 10

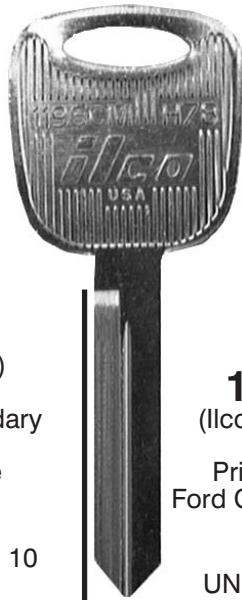

H78  
Codes: A-B-  
C-D-E

**19895**  
(Ilco: 1196CM)

Primary Key Blank  
Ford Contour & Mystique  
1996 - On

UNIT PACKAGE: 10

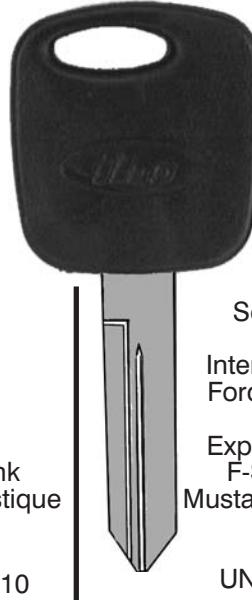

Code: 1X-1706X

**19926**  
(ILCO: H72PT)

Security System  
Key Blank  
Internal Transponder  
Ford Crown Victoria,  
Excursion,  
Expedition, Explorer,  
F-Series Pick Up,  
Mustang, Ranger & Taurus  
2000 - 98

UNIT PACKAGE: 1

## GENERAL MOTORS KEY BLANKS

GM KEY BLANK CHART					
Groove	Years Of Application				
50-A	67	71	75	79	86-83
51-B					
54-C	68	72	76	80	90-87
55-D					
56-E	69	73	77	81	91-On
57-H					
58-J	70	74	78	82	
59-k					

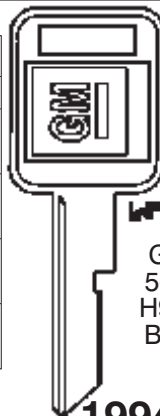

Grv.  
56-E  
H98E  
B-44

**19944**  
(B & S 320404)

U.P. 25

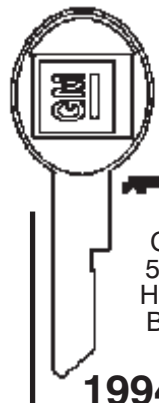

Grv.  
57-H  
H98H  
B-45

**19945**  
(B & S 320405)

U.P. 25

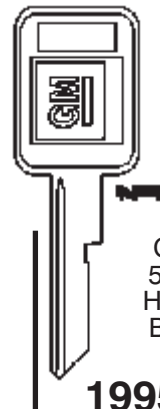

Grv.  
54-C  
H98C  
B-50

**19957**  
(B & S 320652)

U.P. 25



Grv.  
55-D  
H98D  
B-51

**19958**  
(B & S 320653)

U.P. 25

**Larger Quantities  
Available**

**GENERAL MOTORS KEY BLANKS (Cont.)**



Grv.  
50-A  
H98A  
B-48

**19954**  
(B & S 320588)

U.P. 25



Grv.  
51-B  
H98B  
B-49

**19955**  
(B & S 320589)

U.P. 25



Grv.  
58-J  
H98J  
B-46

**19948**  
(B & S 320470)

U.P. 25



Grv.  
59-K  
H98K  
B-47

**19949**  
(B & S 320471)

U.P. 25



Grv.  
55-D

**19988**  
(B & S 321671)

Cadillac  
Double Crest  
U.P. 5



Grv.  
15  
B10

**19928**  
(B & S 32318)

1966-36

U.P. 10



15  
B11

**19929**  
(B & S 32319)  
1966-36

U.P. 10



Grv.  
55-D  
B67

**19982**  
(B & S 321622)  
"W" Bodies  
1990-88

U.P. 10



Grv.  
57-H  
B-79

**20008**  
(B & S 321951)  
"W" Bodies  
1991-On

U.P. 15

**Sec. 21**

**GENERAL MOTORS KEY BLANKS (Cont.)**

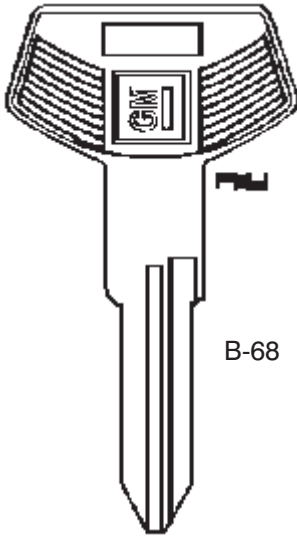

B-68

**20010**

(B & S 322046)  
Double Side

U.P. 10

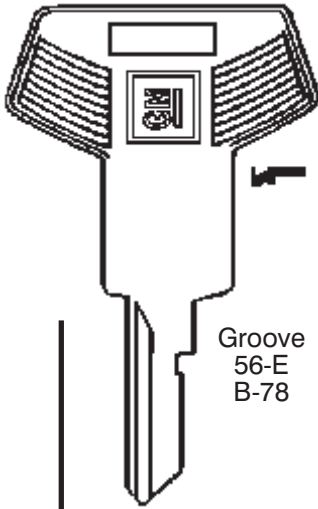

Groove  
56-E  
B-78

**20011**

(B & S 322050)

U.P. 10

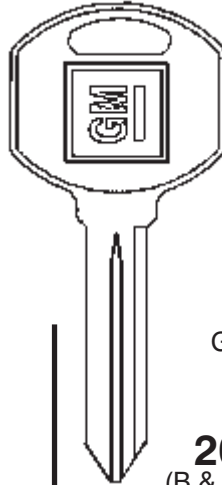

Groove  
75  
B85

**20108**

(B & S 322177)

Secondary  
Key Blank

Achieva, Grand Am  
& Skylark  
1995-94

U.P. 10

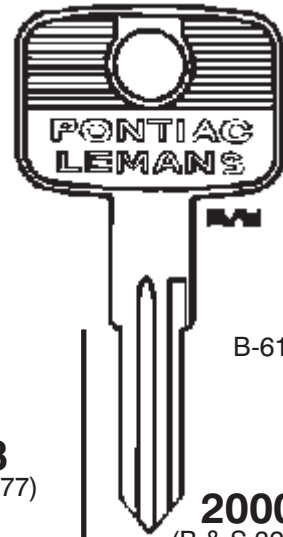

B-61

**20002**

(B & S 321820)

Pontiac LeMans  
PLA Series

U.P. 10

GM KEY BLANK CHART					
Groove	Years Of Application				
50-A	67	71	75	79	86-83
51-B					
54-C	68	72	76	80	90-87
55-D					
56-E	69	73	77	81	91-On
57-H					
58-J	70	74	78	82	
59-K					

**LARGER  
QUANTITIES  
AVAILABLE**



B-65

**20006**

(B & S 321836)  
Geo Metro  
GMA Series

U.P. 10



B-72

**20007**

(B & S 321909)  
Geo Prizm  
GP Series

U.P. 10



B-70

**20012**

(B & S 322079)  
Geo Storm  
GST Series

U.P. 10

**Au-ve-co**  
PRODUCTS Display Boards Are  
Great Selling Tools. Use  
Them To Help Boost Your  
Sales. Refer To The Color  
Pages At The Front  
Of The Catalog.



**GENERAL MOTORS KEY BLANKS (Cont.)**

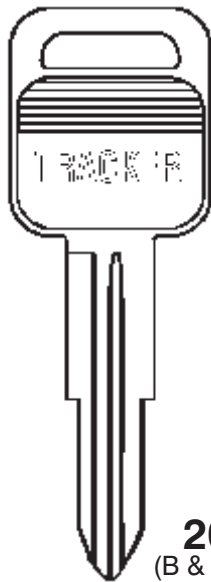

Grv.  
GTA  
B-69

**20109**  
(B & S 321846)

Geo Tracker  
1995-89

U.P. 10



Groove  
50-A  
H98A

**20022**  
(B & S 593196)

U.P. 25



Groove  
51-B

**20023**  
(B & S 593197)

U.P. 25



Groove  
54-C

**20029**  
(B & S 594032)

U.P. 10



Groove  
55-D

**20025**  
(B & S 593719)

U.P. 5

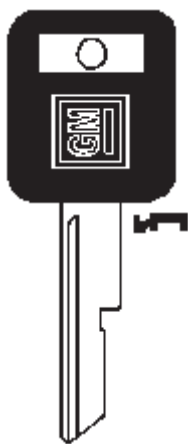

Groove  
56-E

**20033**  
(B & S 595311)

U.P. 10



Groove  
57-H

**20032**  
(B & S 595198)

U.P. 10



Groove  
54-C  
B63

**20027**  
(B & S 593942)  
Beretta & Corsica  
1990-87

U.P. 10



Groove  
56-E  
B-77

**20034**  
(B & S 595313)  
Beretta & Corsica  
1991-On

U.P. 10

**GENERAL MOTORS KEY BLANKS (Cont.)**

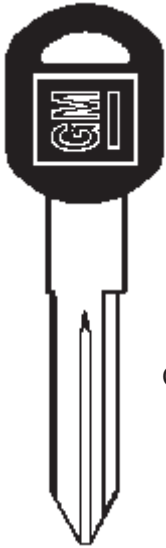

Groove  
75  
10 Cut  
B-82  
B-86

**20088**

(B & S 595936,  
597500)  
Ignition Key Blank  
Cavalier & Sunbird 1995  
Achieva  
Grand Am &  
Skylark 1995-94

U.P. 10



Groove 75  
B89

**20149**

(B & S 597749;  
GM: 26053314)  
Primary Key  
GM Achieva, Cavalier,  
Grand Am, Skylark &  
Sunfire  
1997-96

U.P. 10



Groove 88

**20151**

(B & S: 597253;  
GM: 26049794)  
Pontiac  
Grand Prix  
1997

U. P. 10



Groove  
75  
10 Cut  
B83

**20089**

(B & S 596222)

Ignition & Door  
Key Blank  
Blazer,  
Suburban,  
Sonoma  
S-10 & Vans  
1996-95

U.P. 10



Groove  
54-C  
B64

**20026**

(B & S 593746)

"W" Bodies  
1990-88

U.P. 10



Groove 75  
B91P

**20146**

(B & S 597791;  
GM: 2852058)

One Key System  
Chevrolet Malibu  
1997

U.P. 10



Groove 75  
B91P

**20147**

(B & S 597796;  
GM: 2852063)

One Key System  
Olds Cutlass  
1997

U.P. 10



Code Series:  
R, T, S.

**20324**

(ILCO: B96-P)

One Key System  
Saturn  
2001 - 97

U.P. 5

**GENERAL MOTORS KEY BLANKS (Cont.)**



Groove 75  
10 Cut

**20156**  
(GM: 2852065)  
(B & S 597798)

One Key System  
Grand AM  
1999-On

UNIT PACKAGE: 10



Groove 75  
10 Cut

**20157**  
(GM: 15026223)  
(B & S 598007)

One Key System  
Astro Van, Full Size  
Pick-Up, S10 & Blazer  
1999-On

UNIT PACKAGE: 10



Groove 75  
10 Cut

**20158**  
(GM: 15026222)  
(B & S 598009)

One Key System  
Jimmy, Safari Van, Sonoma  
P/U, Vandura Full Size Van  
1999-On

UNIT PACKAGE: 10



Groove 75  
10 Cut

**20159**  
(GM: 15028528)  
(B & S 598012)

One Key System  
Bravada  
1999-On

UNIT PACKAGE: 10



The World's Largest  
Selection Of Body  
Hardware & Specialty  
Fasteners.

GM KEY BLANK CHART					
Groove	Years Of Application				
	50-A 51-B	67	71	75	79
54-C 55-D	68	72	76	80	90-87
56-E 57-H	69	73	77	81	91-On
58-J 59-K	70	74	78	82	

**GENERAL MOTORS KEY BLANKS (Continued)**

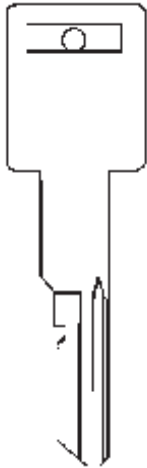

**20093**  
(B & S 321631)  
Vats Work Key

U.P. 5

**GM VATS KEY BLANKS**

Single Sided Primary Vats

**Groove 50 A**

1995 Key Codes:

Primary AA00-7N45 Modular  
Primary 00J0-99J9, Secondary 00L0-99L9  
Primary 00K0-99K9, Secondary 00M0-99L9

Auveco Part No.	Resistor Value	B & S No.	Application	Unit Pkg.
20094	2	595512, 594202	Buick: LeSabre, Park Ave.	1
20095	3	595513, 594203	& Regal	1
20096	4	595514, 594204	Cadillac: Concours, Deville,	1
20097	5	595515, 594205	Eldorado, Fleetwood	1
20098	6	595516, 594206	& Seville	1
20099	7	595517, 594207	Chevrolet: Camaro, Corvette	1
20100	8	595518, 594208	& Lumina	1
20101	9	595519, 594209	Oldsmobile: Cutlass Ciera,	1
20102	10	595520, 594210	Cutlass Supreme,	1
20103	11	595521, 594211	88 Royale & 98	1
20104	12	595522, 594212	Touring Sedan	1
20105	13	595523, 594213	Pontiac: Bonneville, Firebird	1
20106	14	595524, 594214	& Grand Prix	1
20107	15	595525, 594215		1



Groove 50A

**Important:** Resistor value of replacement key must match resistor value of original key.

**GM VATS KEY BLANKS**

Double Sided Primary Vats

**Groove 75**

1996-95 Key Codes:

Primary AA00-7N45 Modular  
Primary 00J0-99J9, Secondary 00L0-99L9  
Primary 00K0-99K9, Secondary 00M0-99L9

Auveco Part No.	Resistor Value	B & S No.	Unit Application	Unit Pkg.
20124	2	596772	Buick Riviera & Oldsmobile Aurora	1
20126	4	596774		1
20127	5	596775		1
20128	6	596776		1
20129	7	596777		1
20131	9	596779		1
20132	10	596780		1
20134	12	596782		1
20135	13	596783		1
20136	14	596784		1
20137	15	596785		1



Groove 75

**Important:** Resistor value of replacement key must match resistor value of original key

# HEAVY DUTY TRUCKS



Groove 85  
Codes: FL001-262

**19844**  
(B & S: 597893;  
Frtln: 22-44567-000)

Primary Key Blank  
Freightliner Century  
1994 - On

UNIT PACKAGE: 10



Grv.  
3

**19966**  
(B & S 320734)  
Kenworth

UNIT PACKAGE: 10



Grv.  
60

**19976**  
(B & S 321490)  
Navistar

UNIT PACKAGE: 10

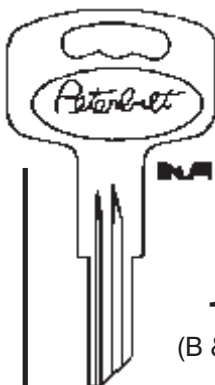

Grv.  
3

**19967**  
(B & S 320774)  
Peterbilt

UNIT PACKAGE: 10



Grv.  
60

**19968**  
(B & S 320886)  
White Motors

UNIT PACKAGE: 10

# IMPORT KEY BLANKS

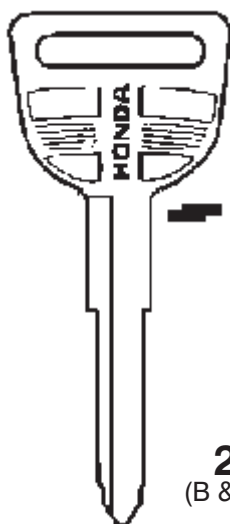

HD-90

**20004**  
(B & S 321833)

Honda  
HD Series

UNIT PACKAGE: 10

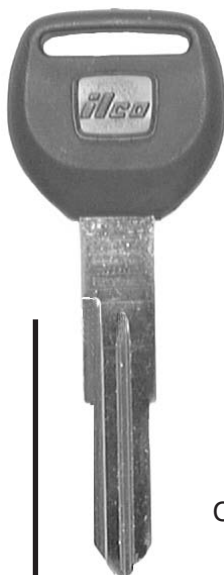

Code Series:  
5001 - 8442

**19811**  
(ILCO: HD103-P)

One Key System  
Acura TL, CL,  
SLX & Integra  
Honda Civic,  
CRV, Del Sol,  
Odyssey, Passport  
& Prelude  
91 - On

UNIT PACKAGE: 5



Groove 75

**20150**  
(B&S 597457;  
Isuzu: 26048001)

Isuzu Hombre  
UNIT PACKAGE: 10

**IMPORT KEY BLANKS (Cont.)**

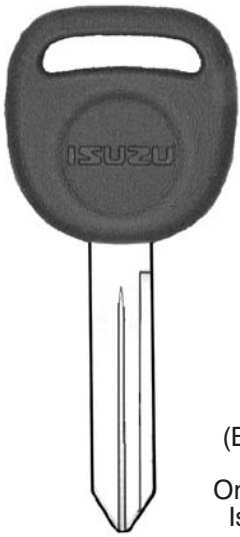

Groove 75  
  
10 Cut  
  
**20161**  
(B & S 598006)  
  
One Key System  
Isuzu Hombre  
1999-On  
  
UNIT PACKAGE: 10

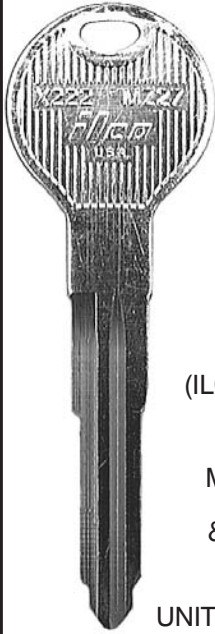

Code Series:  
10100-12283  
  
**20313**  
(ILCO: X222 MZ27)  
  
One Key  
System  
Mazda 626,  
Protege  
& MPV Van  
1997 - 93  
  
UNIT PACKAGE: 10



Code Series:  
E5001 - 7679  
  
**20325**  
(ILCO: MIT4X245)  
  
One Key System  
Mitsubishi  
Diamante,  
Galant & Montero  
2000 - 97  
  
UNIT PACKAGE: 10

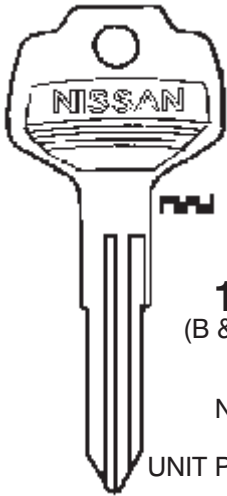

DA25  
  
**19994**  
(B & S 321727)  
  
Nissan  
NA Series  
  
UNIT PACKAGE: 10

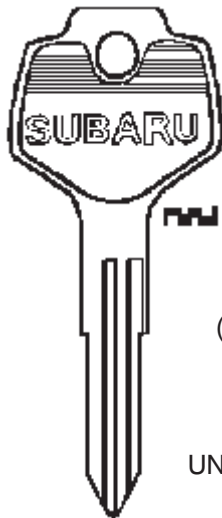

SR-5  
  
**20003**  
(B & S 321829)  
  
Subaru  
SA Series  
  
UNIT PACKAGE: 10

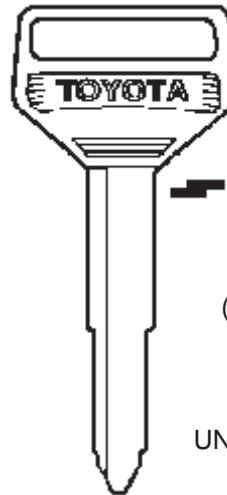

TR33  
  
**19990**  
(B & S 321723)  
  
Toyota  
TA Series  
  
UNIT PACKAGE: 10

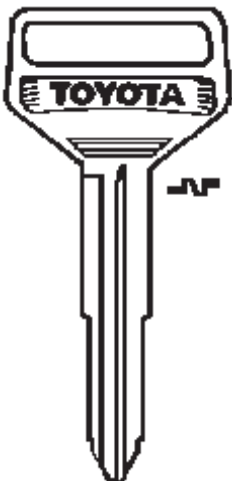

TR37  
  
**19991**  
(B & S 321724)  
  
Toyota Camry  
TB Series  
  
U.P. 10

**E-mail  
Your New Item  
Suggestions  
To mail@auveco.com**

**IMPORT KEY BLANKS (Cont.)**

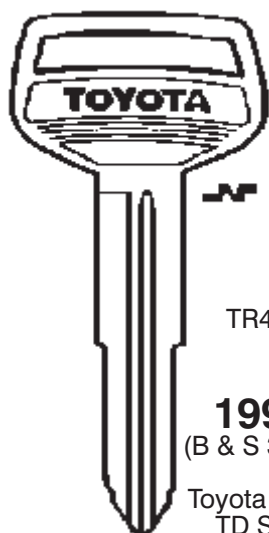

TR40

**19993**  
(B & S 321726)

Toyota Corolla  
TD Series

UNIT PACKAGE: 10

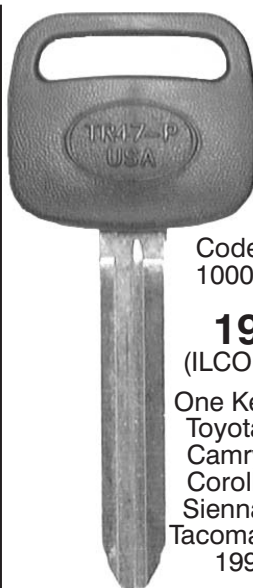

Code Series:  
10001-15000

**19812**  
(ILCO: TR47-P)

One Key System  
Toyota Avalon,  
Camry, Celica,  
Corolla, RAV4,  
Sienna, Solara,  
Tacoma & Tundra  
1992 - On

UNIT PACKAGE: 5



Code Series:  
AH1-9282

**20394**  
(ILCO: V35-P)

One Key System  
VW Cabrio, Corrado,  
Golf & Jetta 1999 - 88  
Passat 1997 - 90  
Eurovan 2000 - 99

UNIT PACKAGE: 5

**JEEP KEY BLANKS**

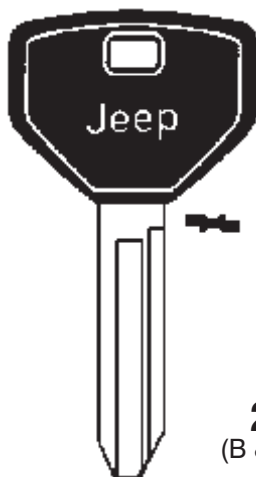

Grv.  
78

**20036**  
(B & S 595917)

UNIT PACKAGE: 10

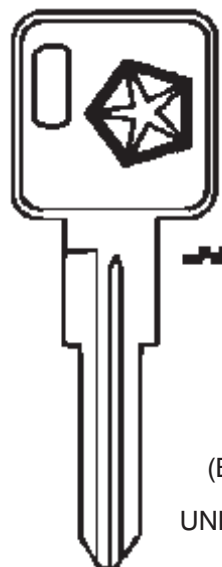

YMOS  
RN32

**20000**  
(B & S 321802)

UNIT PACKAGE: 10

**The Auveco FC-1 Flip Chart Is A Great Selling Tool.  
Use It To Help Boost Your Sales.  
Refer To The Color Pages At The Front Of The Book.**

**TUMBLERS, SPRINGS & RETAINERS**

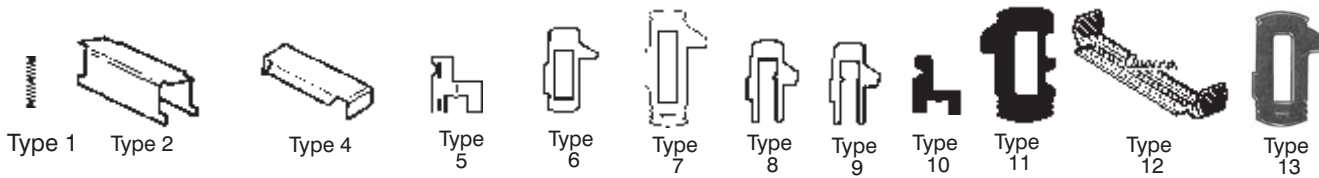

Auveco Part No.	Briggs & Stratton No.	Illus. Type	Description	Unit Pkg.
19932	46648	1	GM, Chrysler & AMC Tumbler Spring, 7/16" Long, 5/64" O.D.	100
19933	46890	1	Chrysler Double Bitted Tumbler Spring, 17/64" Long, 1/16" O.D.	100
20115	56028	1	GM Tumbler Spring, 10 Cut, Sidebar Ignition, 5/16" Long, 5/64" O.D.	25
19936	320126	2	Ford Tumbler Retainer, 7/32" Wide, 3/4" Long	10
19971	321127	4	GM Side Bar Tumbler Retainer, 7/32" Wide, 5/8" Long	100
19938	320291	5	GM & Jeep Side Bar Tumbler #1, .025 Depth Charge	50
19939	320292	5	GM & Jeep Side Bar Tumbler #2, .025 Depth Charge	50
19940	320293	5	GM & Jeep Side Bar Tumbler #3, .025 Depth Charge	50
19941	320294	5	GM & Jeep Side Bar Tumbler #4, .025 Depth Charge	50
19942	320295	5	GM & Jeep Side Bar Tumbler #5, .025 Depth Charge	50
19956	320606	6	GM & H.D. Truck Snap-In Tumbler #1, .025 Depth Charge	100
19960	320667	6	GM & H.D. Truck Snap-In Tumbler #3, .025 Depth Charge	100
19961	320668	6	GM & H.D. Truck Snap-In Tumbler #4, .025 Depth Charge	100
19962	320669	6	GM & H.D. Truck Snap-In Tumbler #5, .025 Depth Charge	100
19996	321762	7	Chrysler, Jeep & GM Saturn Double Bitted Tumbler #2	50
19997	321763	7	Chrysler, Jeep & GM Saturn Double Bitted Tumbler #3	50
19998	321764	7	Chrysler, Jeep & GM Saturn Double Bitted Tumbler #4	50
19963	320690	8	GM & H.D. Truck Retainer Tumbler (Standard), .025 Depth Charge	50
19964	320698	9	GM & H.D. Truck Retainer Tumbler (Standard), .025 Depth Charge	50
20111	322521	10	GM Sidebar Ignition Tumbler, #1 Depth, 10 Cut	25
20112	322522	10	GM Sidebar Ignition Tumbler, #2 Depth, 10 Cut	25
20113	322523	10	GM Sidebar Ignition Tumbler, #3 Depth, 10 Cut	25
20114	322524	10	GM Sidebar Ignition Tumbler, #4 Depth, 10 Cut	25
20116	322117	12	GM Tumbler Retainer, 10 Cut, Sidebar Ignition	15
20117	322241	11	GM Door & Deck Lock Cylinder Tumbler, #1 Depth, 10 Cut	25
20118	322242	11	GM Door & Deck Lock Cylinder Tumbler, #2 Depth, 10 Cut	25
20119	322243	11	GM Door & Deck Lock Cylinder Tumbler, #3 Depth, 10 Cut	25
20120	322244	11	GM Door & Deck Lock Cylinder Tumbler, #4 Depth, 10 Cut	25
20141	322361	13	Chrys./Jeep Wide Body Tumbler, #1 Depth, Double Bitted	25
20142	322362	13	Chrys./Jeep Wide Body Tumbler, #2 Depth, Double Bitted	25
20143	322363	13	Chrys./Jeep Wide Body Tumbler, #3 Depth, Double Bitted	25
20144	322364	13	Chrys./Jeep Wide Body Tumbler, #4 Depth, Double Bitted	25



## CAPS, SHUTTERS & SPRINGS

**Sec. 21**



Auveco Part No.	Briggs & Stratton No.	Illus. Type	Description	Unit Pkg
20154	59885	1	GM & Jeep Shutter (Chrome)	10
20028	593986	1	GM & Jeep Shutter (Black)	5
20031	594190	2	Cadillac "Eyebrow" Shutter (Chrome)	5
19943	320395	3	GM Standard Cap (Chrome), 15/32" I.D., 1-1/8" O.D., 9/32" O.H.	10
19989	321710	5	Chry Deck/Tailgate Lock Cap (Lg Black), 7/16" I.D., 1-3/8" O.D., 5/16" O.H.	.5
19969	320969	6	GM Optic Cap (Chrome), 9/16" I.D., 1-1/8" O.D., 3/8" O.H.	5
19980	321563	6	GM Optic Cap (Black), 9/16" I.D., 1-1/8" O.D., 3/8" O.H.	5
20014	322144	9	GM Snap Cap (Chrome), 15/32" I.D., 13/16" O.D., 3/8" O.H.	5
19965	320725	10	Camaro/Firebird Cap (Chrome), 15/32" I.D., 1-1/8" O.D., 3/4" O.H.	1

O.H. - Overall Height

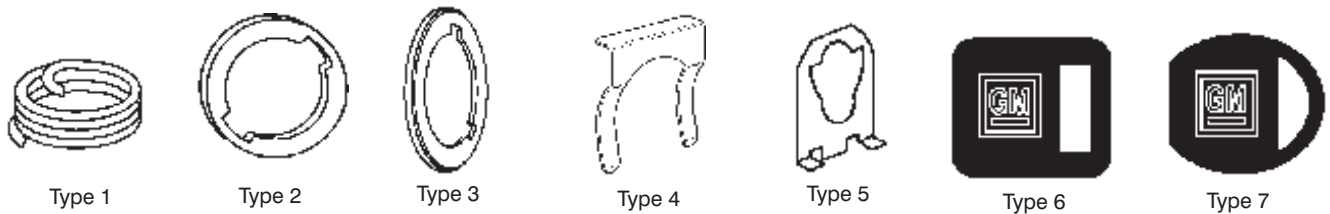

## HARDWARE & ACCESSORIES

Auveco Part No.	Briggs & Stratton No.	Description	Unit Pkg.
19931	46399	1 GM Lock Cylinder Return Spring, 5/8" Coil I.D., 11/16" Coil O.D.	25
19934	47522	2 GM Door Lock Gasket, 1-5/8" O.D.	50
19935	47544	3 GM Deck Lock Gasket, 1-5/16" O.D.	50
19975	321480	4 Universal Lock Cylinder Retainer Clip	10
19977	321963	5 GM Pawl Retainer Clip	10
20015	380055	6 GM Rectangular Key Boot (Black)	25
20016	380060	7 GM Oval Key Boot (Black)	25
20017	380537	7 GM Oval Key Boot (Gray)	25

**CHRYSLER**

Visit The  Web  
Site At  
[www.auveco.com](http://www.auveco.com)

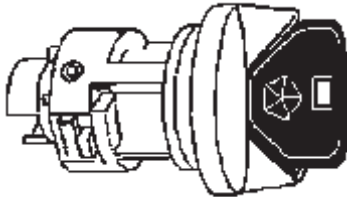

**20087**  
(B & S 701757)

Ignition Lock (Push To Lock)  
Black Cylinder, Molded Key  
1992-90

UNIT PACKAGE: 1

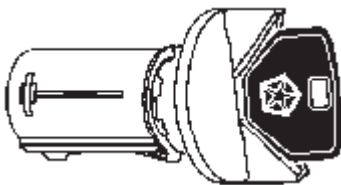

**20062**  
(B & S 700140)

Ignition Lock  
Chrome Cylinder, Molded Key  
For Tilt Wheels 1989-85

UNIT PACKAGE: 1

The World's Largest  
Selection Of Body  
Hardware & Specialty  
Fasteners

**CHRYSLER (Cont.)**

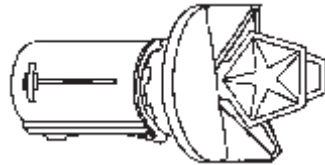

**20063**  
(B & S 700510)

Ignition Lock  
Chrome Cylinder  
For Tilt Wheels 1984-74

UNIT PACKAGE: 1

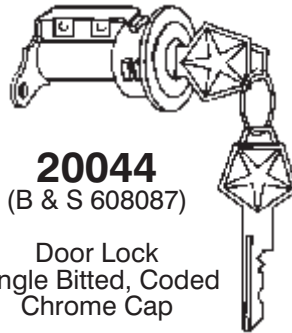

**20044**  
(B & S 608087)

Door Lock  
Single Bitted, Coded  
Chrome Cap

UNIT PACKAGE: 1

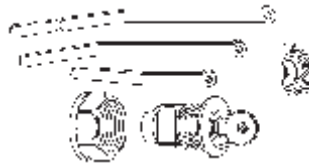

**20076**  
(B & S 700986)

Deck Lock  
Coded, Chrome Cap  
1989-73

UNIT PACKAGE: 1

Visit The Auveco  
Web Site At  
[www.auveco.com](http://www.auveco.com)  
For The Latest  
Information On  
New Items.

**FORD**

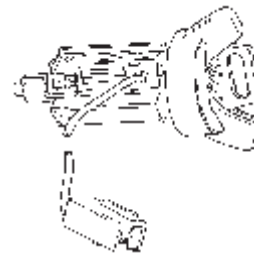

**20059**  
(B & S 609485)  
Ignition Lock,  
Coded, Chrome Cylinder  
Ford 1989-78

UNIT PACKAGE: 1

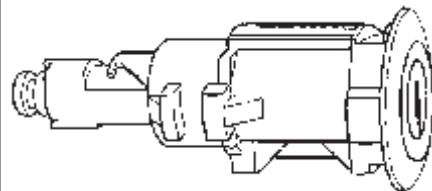

**20058**  
(B & S 608845)  
Deck & Tailgate Lock  
(Groove 48)  
Uncoded, Chrome Cap  
Ford 1981-On

UNIT PACKAGE: 1

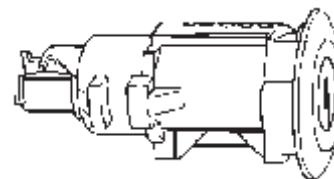

**20053**  
(B & S 608435)  
Deck & Tailgate Lock  
(Groove 48)  
Uncoded, Chrome Cap  
Ford 1975-On

UNIT PACKAGE: 1

## FORD (Cont.)

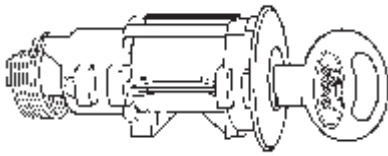

### 20043

(B & S 608076)

Deck & Tailgate Lock  
(Groove 48)  
Coded, Chrome Cap  
Ford 1975-On

UNIT PACKAGE: 1

## GENERAL MOTORS (Con't.)

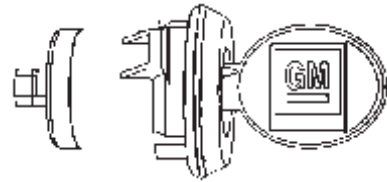

### 20047

(B & S 608170)

Door, Deck & Tailgate Lock  
Coded, Chrome Cap  
Short (7/32") Shaft Length  
GM 1977-On

UNIT PACKAGE: 1

## GENERAL MOTORS

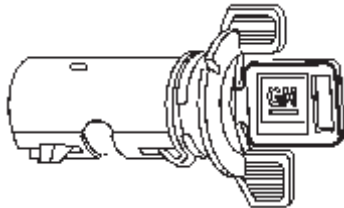

### 20079

(B & S 609530, 701398)

Ignition Lock  
Coded, Chrome Cylinder  
GM w/ Retaining Screw  
1979-On

UNIT PACKAGE: 1

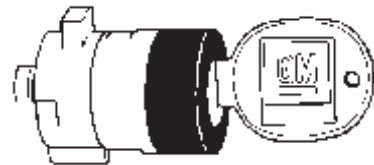

### 20066

(B & S 700740)

Door Lock  
Coded, Black Chrome Cap  
Beretta 1987-On

UNIT PACKAGE: 1

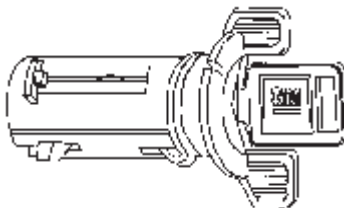

### 20042

(B & S 607893)

Ignition Lock  
Coded, Chrome Cylinder  
GM w/ Locking Column  
1978-69

UNIT PACKAGE: 1

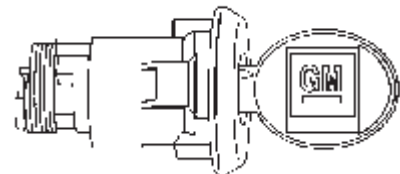

### 20038

(B & S 605533)

Deck & Tailgate Lock  
Coded, Chrome Cap  
Vertical Clip  
GM 1977-On

UNIT PACKAGE: 1

**The World's Largest Selection  
Of Body Hardware  
& Specialty Fasteners  
For The Collision Repair  
Professional**

**Sec. 21**

**GENERAL MOTORS  
(Con't.)**

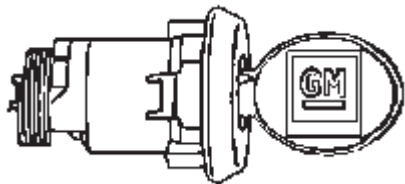

**20020**

(B & S 590637)

Deck & Tailgate Lock  
Coded, Chrome Cap  
Horizontal Clip  
GM 1977-On

UNIT PACKAGE: 1



**20068**

(B & S 700744)

Tailgate Lock  
Coded, Chrome Cap  
Century, Celebrity, Cutlass  
Ciera & 6000 Wagon  
(A Body) 1983-On

UNIT PACKAGE: 1

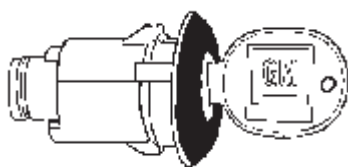

**20069**

(B & S 700745)

Tailgate Lock  
Coded, Black Chrome Cap  
Century, Celebrity, Cutlass  
Ciera & 6000 Wagon  
(A Body) 1983-On

UNIT PACKAGE: 1

**LOCKS & LOCK SETS**

**GENERAL MOTORS  
(Cont.)**



**20074**

(B & S 700845)

Tailgate Lock  
Uncoded, Black Chrome  
S-10, S-15 Blazer  
1983-On

UNIT PACKAGE: 1

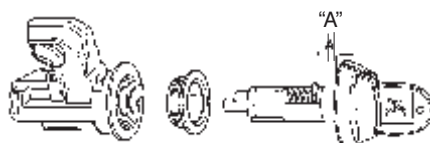

**20046**

(B & S 608168)

Glove Box Lock  
Coded, Chrome Cylinder  
Dimension "A": 19/32" (Long)

UNIT PACKAGE: 1

**FasTrack**  
Auveco's Cost  
Recovery System  
For Repair Fasteners...

**Never Lose Money On  
Fasteners Again!**

**LOCK SETS**

**CHRYSLER**

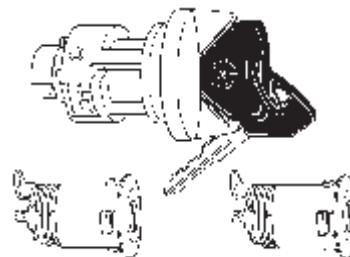

**20080**

(B & S 701511)

(B & S 701757)

Ignition & Door Locks  
Coded, Chrome Cylinder & Caps  
Push To Lock 1992-90

UNIT PACKAGE: 1 Set

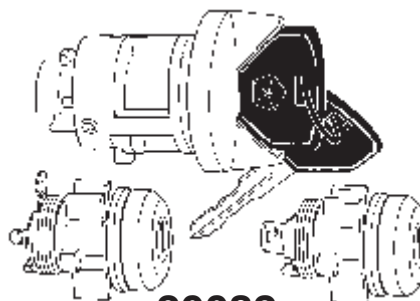

**20082**

(B & S 701513)

(B & S 701757)

Ignition & Door Locks  
Coded, Chrome Cylinder & Caps  
Push To Lock 1992-90

UNIT PACKAGE: 1 Set

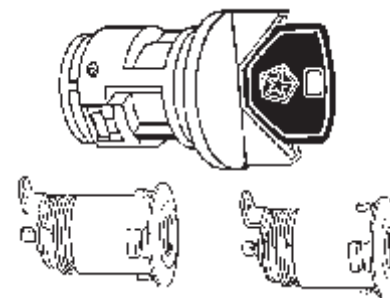

**20081**

(B & S 701512)

(B & S 595022)

Ignition & Door Locks  
Coded, Chrome Cylinder & Caps  
w/o Tilt Wheel 1992-90

UNIT PACKAGE: 1 Set

# LOCKS & LOCK SETS

**Sec. 21**

## CHRYSLER (Continued)

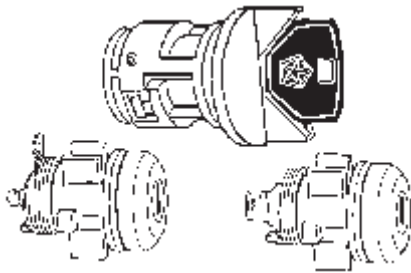

**20083**

(B & S 701514)  
(B & S 595022)

Ignition & Door Locks  
Coded, Chrome Cylinder & Caps  
w/o Tilt Wheel 1992-90

UNIT PACKAGE: 1 Set

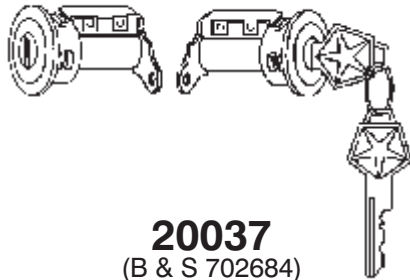

**20037**

(B & S 702684)

Door Locks  
Coded, Chrome Caps

UNIT PACKAGE: 1 Set

**Remember All Items  
Are Available In Bulk.  
Call For A Quote**

## GENERAL MOTORS

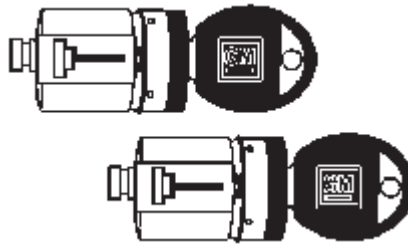

**20075**

(B & S 700851)

Door Locks  
Coded, Black Cap Cover  
Full Size Pick-Up 1988-On  
Full Size Blazer 1992-On

UNIT PACKAGE: 1 Set

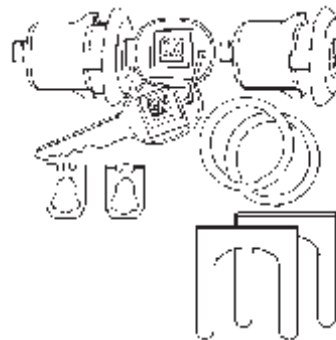

**20048**

(B & S 608307)

Door Locks  
Coded, Chrome Caps  
Short (7/32") Shaft Length  
GM 1977-On

UNIT PACKAGE: 1 Set

**20070**

(B & S 700796)

Same As 20048 Except  
With Black Chrome Caps

UNIT PACKAGE: 1 Set

## GENERAL MOTORS (Cont.)

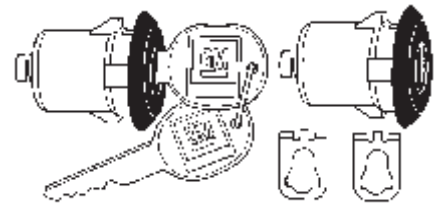

**20071**

(B & S 700806)

Door Locks  
Coded, Black Chrome Caps  
Medium (3/8") Shaft Length  
GM 1977-On

UNIT PACKAGE: 1 Set

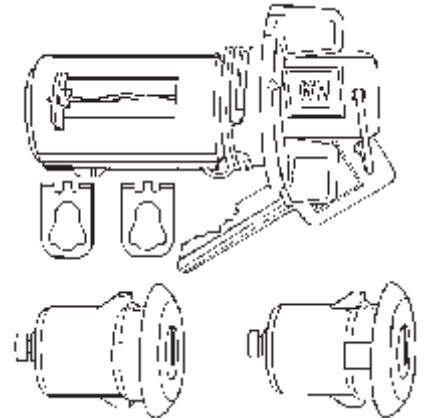

**20049**

(B & S 608312)

Ignition & Door Locks  
Coded, Chrome Cylinder & Caps  
Ignition w/ Locking Cylinder  
Short (7/32") Shaft Length  
On Door Locks  
GM 1978-69

UNIT PACKAGE: 1 Set

**LOCK SETS & LOCK SERVICE PACKAGES**

**GENERAL MOTORS  
(Cont.)**

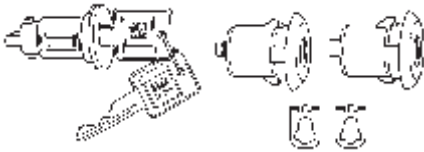

**20055**

(B & S 608441)

Ignition & Door Locks  
Coded, Chrome Caps  
Dash Mounted Ignition  
Short (7/32") Shaft Length  
On Door Locks  
GM 1966-On

UNIT PACKAGE: 1 Set

**GENERAL MOTORS  
(Cont.)**

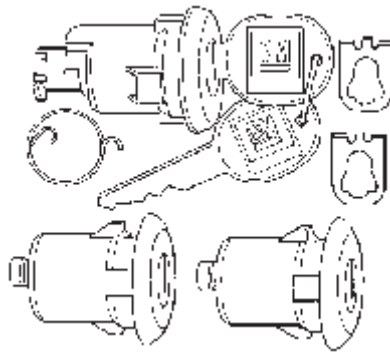

**20052**

(B & S 608339)

Door & Deck Locks  
Coded, Chrome Caps  
Medium (3/8") Shaft Length  
On Door Locks  
Standard Vertical Clip Deck Lock  
GM 1977 - ON

UNIT PACKAGE: 1 Set

**CHRYSLER & JEEP  
(Cont.)**

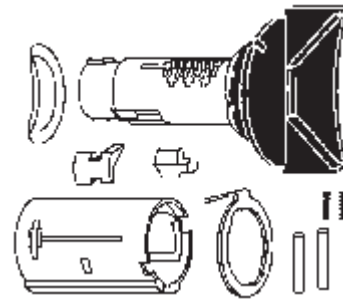

**20077**

(B & S 701245)

Ignition Lock (w/Tilt Wheel)  
Black Chrome Cylinder  
Chrysler 1990 - 89

UNIT PACKAGE: 1

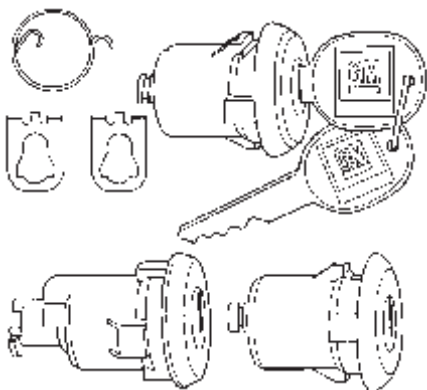

**20051**

(B & S 608333)

Door & Deck Locks  
Coded, Chrome Caps  
Short (7/32") Shaft Length  
On Door Locks  
Standard Vertical Clip Deck Lock  
GM 1977-On

UNIT PACKAGE: 1 Set

**LOCK SERVICE  
PACKAGES**

**CHRYSLER & JEEP**

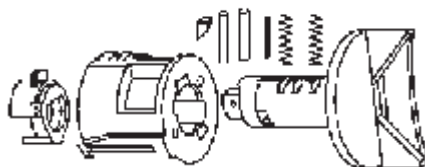

**20078**

(B & S 701247)

Ignition Lock (Push To Start)  
Chrome Cylinder  
Chrysler 1992-90

UNIT PACKAGE: 1

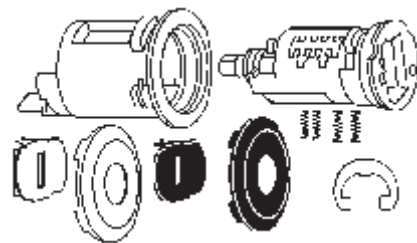

**20086**

(B & S 701714)

Door Lock  
Double Bitted, Groove 73  
Chrysler & Jeep 1988-On

UNIT PACKAGE: 1

**LOCK SERVICE PACKAGES**

**CHRYSL. & JEEP (Con't.)**

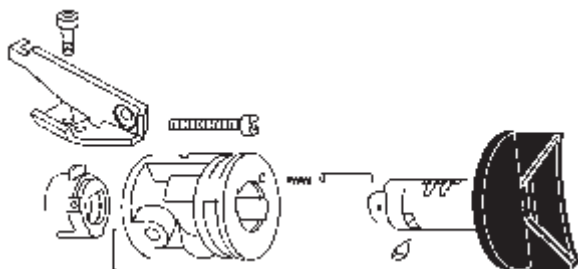

**20138**  
(B & S 702788)

Ignition Lock  
Service Package  
Chrysler LeBaron, Town & Country,  
Caravan, Voyager, Spirit, Ram Van,  
Ram Charger & Dakota 1995  
& Jeep Cherokee 1996

UNIT PACKAGE: 1

**GENERAL MOTORS**

(Continued)

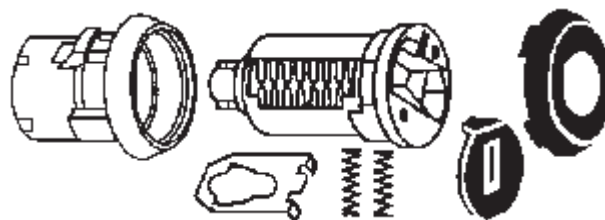

**20073**  
(B & S 700839)

Door Lock  
Black Chrome Cap  
Mini-Van & APV  
Front Door 1984-On

UNIT PACKAGE: 1

**GENERAL MOTORS**

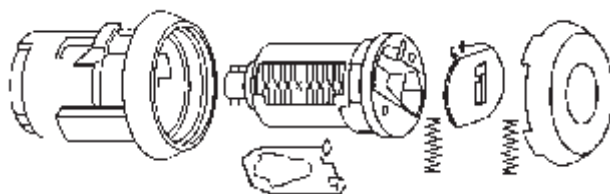

**20040**  
(B & S 607868)

Door, Deck & Tailgate Lock  
Chrome Cap  
Short (7/32") Shaft Length  
GM 1977-On

UNIT PACKAGE: 1

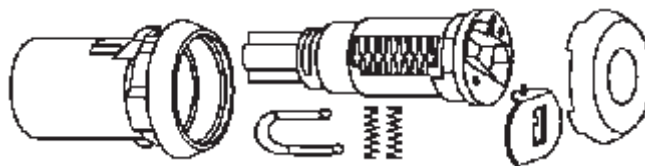

**20041**  
(B & S 607870)

Door Lock  
Chrome Cap  
Long (3/4") Shaft Length  
GM 1977-On

UNIT PACKAGE: 1

Visit The  
Auveco Web Site At

[www.auveco.com](http://www.auveco.com)

For The Latest Information  
On New Items.







**17440**  
(91501-SG0-003)  
Nylon

Body Side Moulding Clip  
Legend 1987-On

UNIT PACKAGE: 15



**19226**  
(90157-SP0-901)  
Nylon

Front Grille Clip  
Acura Legend Coupe  
1991-On  
Honda Odyssey  
1995-On

UNIT PACKAGE: 15



**19225**  
(91501-SP1-003)  
Nylon

Side Sill  
Garnish Moulding Clip  
Legend Coupe  
1991-On

UNIT PACKAGE: 10

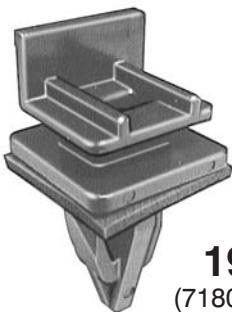

**19423**  
(71807-SLO-000)  
Nylon

Side Sill Garnish  
Upper Clip  
NSX  
1991-On

UNIT PACKAGE: 10



**19507**  
(91504-SP1-003)  
White Nylon

Fender Moulding Clip  
Legend Coupe  
1995 - 91

UNIT PACKAGE: 5



**19740**  
(90666-SSO-003)  
White Nylon

Roof Moulding Clip  
Acura Integra & Legend  
Honda Prelude  
1992-On

UNIT PACKAGE: 10



**17323**  
(91513-SP0-003)  
Teal Nylon

Windshield Side Moulding Clip  
Use With 17324  
4 Door Legend 1991-On

UNIT PACKAGE: 10



**17324**  
(91511-SP0-003)  
Teal Nylon

Windshield Side Moulding Clip  
Use With 17323  
4 Door Legend 1991-On

UNIT PACKAGE: 10

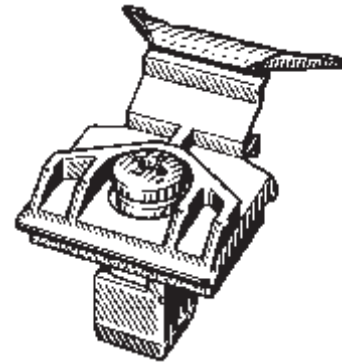

**18235**  
(91575-SL4-0040)  
Black Nylon  
w/Stainless  
Steel Screw

Windshield  
Holder Clip  
Vigor 1992-On

UNIT PACKAGE: 5

Visit The Auveco  
Web Site At  
[www.auveco.com](http://www.auveco.com) For  
The Latest Information  
On New Items.

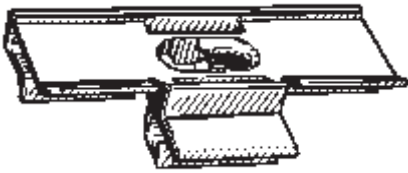

**17326**

(91528-SP0-003)  
Yellow Nylon

Windshield Side Moulding Clip  
Use With 18403  
Acura 4 Door Legend 1991-On  
Honda Accord 1991-On

UNIT PACKAGE: 10



**17280**

(91505-SG0-003)  
Orange Nylon

Windshield Moulding Clip  
Honda Prelude 1988-On  
Acura Legend 1988-On

UNIT PACKAGE: 10



**17282**

(91534-SM4-003)  
White Nylon

Windshield Moulding Clip  
Honda Accord 1990-On  
Acura Legend 1991-On

UNIT PACKAGE: 10



**18756**

(90621-SK7-003)  
White Nylon

Windshield Corner Moulding Clip  
Integra 1993-90

UNIT PACKAGE: 5



**18761**

(91536-SP0-003)  
Light Blue Nylon

Windshield Corner Moulding Clip  
Legend 4 Door 1991-On

UNIT PACKAGE: 5



**18755**

(91513-SP1-003)  
Gray Nylon

Windshield Side Moulding Clip  
Legend Coupe  
1991-On

UNIT PACKAGE: 10

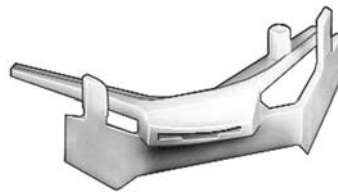

**18763**

(90611-SK7-003)  
White Nylon

Windshield Corner Moulding Clip  
Integra 1993-90

UNIT PACKAGE: 5

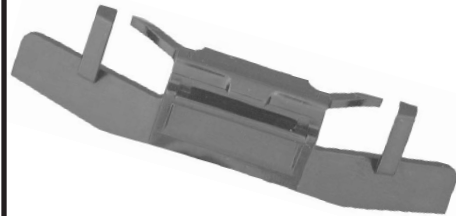

**19668**

(91533-ST0-003)  
Yellow Nylon

Windshield Moulding Clip  
Integra  
1994-On

UNIT PACKAGE: 10



**18759**

(90601-SK7-003)  
Green Nylon

Windshield Side Moulding Clip  
Integra 3 & 4 Door  
1993-90

UNIT PACKAGE: 15



**19227**

(8-94467-458-5,  
8-97134-978-0)  
Nylon

Windshield Moulding Clip  
SLX  
1996-On

UNIT PACKAGE: 10



**18764**  
(91514-SP0-003)  
Yellow Nylon

Windshield Side Moulding Clip  
Legend 4 Door  
1991-On

UNIT PACKAGE: 5



**18765**  
(90612-SK7-003)  
White Nylon

Windshield Side Moulding Clip  
Integra 1993-90

UNIT PACKAGE: 10



**19478**  
(91574-SV2-003)  
Yellow Nylon

Windshield Moulding Clip  
Acura 2.2CL, 2.3CL & 3.0CL;  
Honda Accord  
1994 - On

UNIT PACKAGE: 15

**18757**  
(91527-SP1-003)  
Green Nylon



Windshield Side Moulding Clip  
Legend 2 Door 1991-On

UNIT PACKAGE: 5



**18754**  
(91535-SP0-003)  
Green Nylon

Windshield Corner Moulding Clip  
Legend 4 Door  
1991-On

UNIT PACKAGE: 5



**18768**  
(91526-SP0-003)  
White Nylon

Windshield Side Moulding Clip  
Legend 4 Door  
1991-On

UNIT PACKAGE: 5



**19476**  
(91577-SV4-003)  
Red Nylon

Windshield Left-Hand Corner  
Moulding Clip  
Acura 2.2CL, 2.3CL & 3.0CL;  
Honda Accord & Odyssey  
1994 - On

UNIT PACKAGE: 10

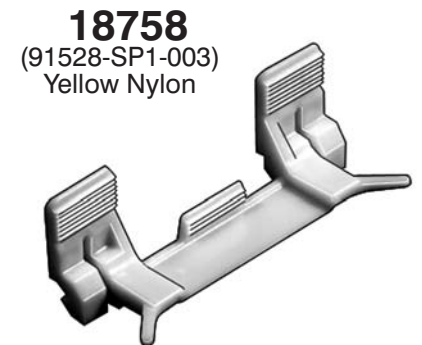

**18758**  
(91528-SP1-003)  
Yellow Nylon

Windshield Side Moulding Clip  
Legend 2 Door  
1991-On

UNIT PACKAGE: 5

The Auveco FC-1  
Flip Chart Is A Great  
Selling Tool.  
Use It To Help  
Boost Your Sales.  
Refer To The Color  
Pages At The Front  
Of The Book.



**19477**  
(91576-SV4-003)  
Green Nylon

Windshield Right-Hand Corner  
Moulding Clip  
Acura 2.2CL, 2.3CL & 3.0CL;  
Honda Accord & Odyssey  
1994 - On

UNIT PACKAGE: 10



**18760**

(91514-SP1-003)  
Red Nylon

Windshield Side Moulding Clip  
Legend 2 Door  
1991-On

UNIT PACKAGE: 5



**18767**

(91526-SP1-003)  
Blue Nylon

Windshield Side Moulding Clip  
Legend 2 Door 1991-On

UNIT PACKAGE: 5

Please Order In Unit  
Package Quantities  
Not Number Of  
Pieces



**18762**

(91512-SP1-000)  
Black Nylon

Windshield Upper Moulding Clip  
Legend 2 Door  
1991-On

UNIT PACKAGE: 5

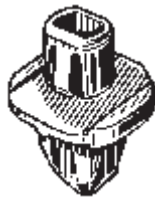

**18456**

(90661-ST7-003)  
Nylon

Bumper Clip  
Integra 1994-On

UNIT PACKAGE: 5



**17608**

(91568-SL4-003)  
Black Nylon

Windshield Side Moulding Clip  
Vigor 1992-On

UNIT PACKAGE: 15



**19479**

(91561-SW5-003)  
White Nylon

Windshield Moulding Clip  
TL 2.5 & 3.2  
1996 - On

UNIT PACKAGE: 15



**17445**

(91502-SG0-003)  
White Nylon

Windshield Moulding Clip  
Legend  
1988-On

UNIT PACKAGE: 10



**17268**

(90676-SD2-003)  
White Nylon

Quarter Window  
Moulding Clip  
Integra 1985-On

UNIT PACKAGE: 15

# ACURA CLIPS & FASTENERS

**Sec. 22**

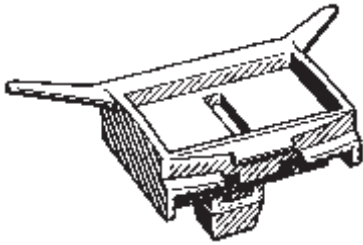

**18236**  
(91537-SP0-013)  
White Nylon

Windshield Clip  
Legend 1991-On

UNIT PACKAGE: 10



**19734**  
(90107-SX0-003)  
Black Nylon

Bumper Grommet  
#10 Screw Size  
Acura 2.2CL, 2.3CL,  
2.5TL, 3.2TL, 3.5RL  
Honda Accord & Prelude  
1996-On

UNIT PACKAGE: 15



**19679**  
(91641-SH3-013)  
Yellow Nylon  
w/ Steel Insert

Garnish Moulding Grommet  
Head Diameter: 14mm x 26mm  
Acura Integra, Honda Civic  
& Prelude  
1988 - On

UNIT PACKAGE: 10



**19465**  
(91652-SPO-003)  
Natural Nylon

Center Pillar Garnish  
Screw Grommet  
#4 Screw Size 3.5 RL  
1996 - On

UNIT PACKAGE: 15



**19463**  
(91651-SZ3-003)  
Natural Nylon

Inner Front Door Lining  
Sash Garnish Grommet 3.5RL  
1996 - On

UNIT PACKAGE: 10



**19723**  
(91503-SK7-013)  
Saddle Tan Nylon

Center Pillar Moulding  
Screw Grommet  
#4 Screw Size  
Head Size: 10mm x 14mm  
Stem Length: 10mm  
Integra  
1994 - On

UNIT PACKAGE: 15



**20472**  
(91512-SR3-004)  
White Nylon

Tubular Nut  
With Sealer & Sealed End  
3mm Stud Size  
Head Dia: 8.5mm  
Fits Into 6mm Hole  
Emblem Nut  
Acura Integra,  
Honda Accord, Civic, CRV & Prelude  
1994 - On

UNIT PACKAGE: 10



**18877**  
(91530-SP1-003)  
Orange Nylon

Weatherstrip Retainer  
Head Size: 5mm x 15mm  
Stem Length: 10mm  
Fits Into 6mm Hole  
Acura 3.5 RL;  
Accord, Civic & Odyssey  
1992-On

UNIT PACKAGE: 25



**18114**  
(91520-SM4-C010)  
Black Nylon

Hood Insulation Retaining Clip  
Head Diameter: 10mm  
Stem Length: 10mm  
Panel Thickness: 4mm  
Fits Into 6mm Hole  
Honda & Acura 1990-On

UNIT PACKAGE: 25



**19506**  
(90666-SA7-003ZW)  
Black Nylon

Trunk Lining Retainer  
Head Diameter: 16mm  
Stem Diameter: 5mm Square  
Stem Length: 16mm  
Acura 2.5TL, 3.2TL, 3.5,  
Integra & Legend,  
Honda Accord Wagon & Prelude  
1987 - On

UNIT PACKAGE: 15



**19467**  
(91501-SL4-003)  
Black Nylon

Front Cowl Retaining Clip  
Head Diameter: 13mm  
Stem Diameter: 6mm  
Stem Length: 10mm  
3.5RL  
1996 - On

UNIT PACKAGE: 25



**19114**  
(91518-SM4-003)  
Black Nylon

Hood & Trunk Moulding  
Retaining Clip  
Head Diameter: 12mm  
Stem Length: 9mm  
Fits Into 6mm Hole  
Acura Integra & Honda Civic  
1994-On

UNIT PACKAGE: 10



**19229**  
(8-94215-211-0)  
Black Nylon

Fender Mud Skirt  
Retainer  
Acura SLX 1996-On  
Honda Passport 1995-93

UNIT PACKAGE: 15



**19483**  
(91515-SR3-000)  
Black Nylon

Rear Hood Cowl  
Weatherstrip Retaining Clip  
Head Size: 8mm x 18mm  
Stem Length: 15mm  
Fits Into 7mm Hole  
Acura Integra, Honda Civic, CR-V  
And Del Sol  
1992 - On

UNIT PACKAGE: 25



**19746**  
(91652-SZ3-003)  
White Nylon

Door Lining Retainer  
Head Diameter: 10.5mm  
Stem Length: 15mm  
3.5RL  
1996-On

UNIT PACKAGE: 10



**19230**  
(8-97098-397-0)  
Gray Nylon

Headliner Retainer  
Head Diameter: 25mm  
Stem Diameter: 9mm  
Stem Length: 11mm  
SLX 1996-On

UNIT PACKAGE: 15



**18746**  
(90700-SJ4-000)  
Black Nylon

Hood Insulation Retainer  
Head Diameter: 30mm  
Stem Diameter: 10mm  
Stem Length: 6mm  
Legend 1991-On  
Honda 1998-On

UNIT PACKAGE: 15



**20609**  
(91501-S1K-003)  
Black Nylon

Hood Insulation Retainer  
Head Diameter: 30mm  
Stem Diameter: 15mm x 20mm  
Stem Length: 14mm  
Acura 3.5RL & RSX and  
Honda Civic & CR-V  
2000 - On

UNIT PACKAGE: 25



**19466**  
(91560-SZ3-003)  
White Nylon

Door Trim Panel Retainer  
Small Head Diameter: 13mm  
Large Head Diameter: 17mm  
Stem Diameter: 9.5mm  
Stem Length: 12mm  
3.5RL 1996 - On

UNIT PACKAGE: 15



**19464**  
(90667-SD4-003)  
Natural Nylon

Roof Lining Retainer  
Small Head Diameter: 13mm  
Large Head Diameter: 16mm  
Stem Diameter: 7mm  
Stem Length: 7mm  
NSX, 2.2CL & 2.3CL  
1991 - On

UNIT PACKAGE: 15



**19145**  
(91560-SP0-003)  
Gray Nylon

Front & Rear Door  
Trim Panel Retainer  
Small Head Dia: 13mm  
Large Head Dia: 17mm  
Stem Diameter: 9mm  
Stem Length: 12mm  
Acura Integra & Legend  
Honda Accord, Civic,  
Prelude, Odyssey & Del Sol  
1991-On

UNIT PACKAGE: 25



**20411**  
(91560-S84-A11)  
Black Nylon

Windshield Garnish  
Pillar Retainer  
Top Head Dia: 13mm  
Middle Head Dia: 16mm  
Bottom Head Dia: 14.5mm  
Stem Diameter: 9.5mm  
Stem Length: 12mm  
Acura 3.2CL, Honda Accord,  
Insight & Odyssey  
1998 - On

UNIT PACKAGE: 15



**19186**  
(90657-SB0-003)  
Black Nylon

Front Bumper Cover  
Push-Type Retainer  
Head Diameter: 11mm  
Stem Length: 10mm  
Fits Into 8mm Hole  
Acura Legend, Honda Accord &  
Odyssey  
1991-On

UNIT PACKAGE: 10



**19232**  
(91502-SZ5-003)  
Black Nylon

Front Fender  
Push-Type Retainer  
Head Diameter: 17mm  
Stem Length: 13mm  
Fits Into 7mm Hole  
3.5 RL Sedan  
1996-On

UNIT PACKAGE: 10



**19233**  
(Acura: 91503-SZ3-003;  
Honda: 91503-SZ5-003)  
Black Nylon

Front Bumper Push-Type Retainer  
Head Diameter: 20mm  
Stem Length: 13mm  
Fits Into 10mm Hole  
Acura 3.5 RL Sedan & Honda  
1996-On

UNIT PACKAGE: 15



**19140**  
(Acura: 90505-SL0-003;  
GM: 94852368;  
Mitsubishi: MB888869;  
Toyota: 90467-08155)  
Black Nylon

Push-Type Retainer  
Head Diameter: 20mm  
Stem Length: 21mm  
Fits Into 8mm Hole  
Acura, Dodge Avenger,  
Eagle Talon, Geo Prizm, Mitsubishi  
Eclipse & Galant And Toyota  
1993-On

UNIT PACKAGE: 5



**19231**  
(91505-SL0-003)  
Black Nylon

Push-Type Retainer  
Head Diameter: 18mm  
Stem Length: 16mm  
Fits Into 8mm Hole  
NSX  
1991-On

UNIT PACKAGE: 15



**19239**  
(91512-SX0-003)  
Black Nylon

Front Fender  
Push-Type Retainer  
Head Diameter: 20mm  
Stem Length: 11mm  
Fits Into 8mm Hole  
Acura 3.5RL, Honda Accord,  
Prelude & Odyssey 1994-On

UNIT PACKAGE: 25



**20564**  
(91503-SZ5-003)  
Black Nylon

Front & Rear Bumper  
Push-Type Retainer  
Head Diameter: 20mm  
Stem Length: 18mm  
Fits Into 10mm Hole  
Acura 3.5RL and Honda Accord  
& Odyssey  
1996 - On

UNIT PACKAGE: 15

You Can E-Mail  
Your New Item  
Suggestions To  
[mail@auveco.com](mailto:mail@auveco.com)

Do You Want Your  
Customers To Know  
You Use The Best  
Body Hardware &  
Specialty Fasteners  
Available?

Promotional Products  
And Apparel Bearing  
The Auveco Logo  
Promote Your Identity  
As A Professional.

**Sec. 22**

**ACURA CLIPS & FASTENERS**

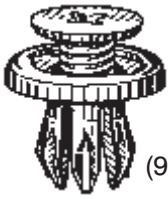

**17267**  
(91503-SP0-003)  
Black Nylon

Front & Rear Bumper  
Push-Type Retainer  
Head Diameter: 20mm  
Stem Length: 15mm  
Fits Into 10mm Hole  
Legend 1991-On

UNIT PACKAGE: 15



**19448**  
(90668-SP0-000)  
Gray Nylon

Trunk Lining Garnish  
Push-Type Retainer  
Head Size: 20mm x 30mm  
Stem Length: 18mm  
(Not Including The Pin)  
Fits Into 10mm Hole  
3.5RL & Legend  
1991 - On

UNIT PACKAGE: 10



Not Actual Size

**20380**

Not Supplied By  
O.E.M.  
Black Nylon

Cable Strap  
Length: 200mm (8")  
Max. Bundle Dia: 44mm (1-3/4")  
Fits Into 6.3mm (1/4") Hole  
Import Cars

UNIT PACKAGE: 25

**BMW CLIP & FASTENERS**



**12641**  
(1-802-389-B)  
Nylon

Body Side Moulding  
Clip With Sealer

UNIT PACKAGE: 25



**17279**  
(5131-1-938-494)  
Nylon

Windshield Moulding Clip  
BMW 7 Series 1987-On

UNIT PACKAGE: 15



**13172**  
(5147-1-840-961)  
Nylon

Plastic Plug

UNIT PACKAGE: 25



**13158**  
(5113-1-804-205)  
Nylon

Moulding Clip  
With Sealer

UNIT PACKAGE: 50



**16117**  
(5113-1-869-959)  
Nylon With  
Zinc & Yellow Screw

Moulding Clip  
13mm Wide, 35mm Long  
Bolt: M4 -.7 x 11mm

UNIT PACKAGE: 25



**20403**  
(51471-840-960)  
White Nylon

Scuff Plate Retainer  
Head Size: 9mm x 12mm  
Stem Length: 12mm  
Fits Into 6mm Hole  
Series 3, 5, Z3 & M  
1992 - On

UNIT PACKAGE: 25

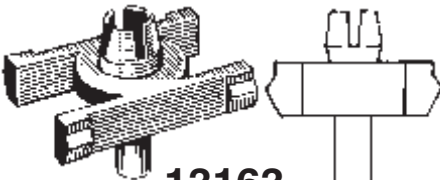

**13163**  
(5113-1-849-724)  
Nylon

Moulding Clip

UNIT PACKAGE: 10



**20333**  
(51-71-8-108-613)  
White Nylon

Cowl & Trunk Trim Clip  
Head Size: 11mm x 14mm  
Stem Length: 11mm  
Fits Into 9mm Hole  
Series 3, 5, 7, & 8  
1989 - On

UNIT PACKAGE: 25



**20255**  
(51-47-1-928-808)  
White Nylon

Scuff Plate Retainer  
Head Size: 11mm x 15mm  
Overall Length: 29mm  
Series 3, 5 & 7  
1987 - On

UNIT PACKAGE: 25

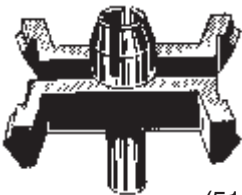

**13171**  
(5113-1-848-312)  
Nylon

Moulding Clip

UNIT PACKAGE: 10



**17645**  
(51711-916-197)  
Nylon

Headlight Cover Retainer  
BMW 3, 5, & 7 Series  
1984-On

**Used With 17646**

UNIT PACKAGE: 25



# BMW CLIPS & FASTENERS

**Sec. 22**



**17646**  
(51711-916-199)  
Nylon

Headlight Cover Grommet  
3, 5 & 7 Series 1984-On  
**Used With 17645**

UNIT PACKAGE: 25



**13166**  
(5118-1-852-299)  
Nylon

Nut Type Fastener

UNIT PACKAGE: 50



**20270**  
(51-48-1-938-725)  
Black Nylon

Hood & Trunk Insulation  
Push-Type Retainer  
Head Dia: 20mm  
Stem Length: 9mm  
Fits Into 7mm Hole  
BMW Series 3, 5 & 7  
2001 - 84

UNIT PACKAGE: 25



**13159**  
(5113-5-680-113)  
Nylon Nut

UNIT PACKAGE: 50



**13164**  
(4133-5-480-120)  
Nylon

Plastic Nut  
4mm Thread

UNIT PACKAGE: 25



**13170**  
(5131-1-802-258)  
Nylon

Barrel Nut  
For 7mm Stud  
Fits Into 8mm Hole

UNIT PACKAGE: 50



**20253**  
(51-41-1-973-500)  
White Nylon

Trim Panel Retainer  
Top Head Dia: 14mm  
Middle Head Dia: 15mm  
Bottom Head Dia: 18mm  
Stem Dia: 9mm  
Stem Length: 15mm  
Series 3, 5 & 7  
1987 - On

UNIT PACKAGE: 50



**20248**  
(51-11-8-174-185)  
Black Nylon

Bumper Trim  
Push-Type Retainer  
Head Diameter: 20mm  
Stem Length: 17mm  
Fits Into 6.3mm Hole  
Series 3, 5 & 7  
1995 - On

UNIT PACKAGE: 25



**20186**  
(51-14-1-902-279)  
Natural Nylon

Emblem Grommet  
Head Diameter: 12mm  
Stem Length: 8mm  
Fits Into 6.8mm Hole  
BMW Series 3, 5, 6 & 7  
2001 - 1986

UNIT PACKAGE: 15



**20254**  
(51-13-8-124-389)  
Black Plastic

Cowl Panel  
Moulding Insert  
Head Dia: 13mm  
Stem Length: 11mm  
Stem Diameter: 9mm  
**Use With Auveco 20388**  
Series 3 & 5  
1989 - On

UNIT PACKAGE: 50



**20234**  
(51-11-1-908-077)  
Black Nylon

Scuff Plate  
Push-Type Retainer  
Head Diameter: 15mm  
Stem Length: 15mm  
Fits Into 6.3mm Hole  
Series 3, 5, & 7  
1984 - On

UNIT PACKAGE: 50



**16115**  
(5113-1-885-399)  
Black Nylon

Push-Type Retainer  
Head Size: 7mm x 15mm  
Stem Length: 17mm  
Fits Into 6mm x 6mm Hole

UNIT PACKAGE: 25



**13167**  
(5121-6-442-159)  
Nylon

Moulding Insert  
UNIT PACKAGE: 25



**20388**  
(51218-205-295)  
Black Nylon

Cowl Vent  
Push-Type Retainer  
Head Diameter: 20mm  
Stem Length: 16mm  
**Use With Auveco 20254**  
Series 5  
1997 - On

UNIT PACKAGE: 50



**20653**  
Gray Nylon

Wire Routing Clip  
Inside Diameter: 7mm x 10mm  
Fits Into 6mm Hole  
BMW & Mercedes

UNIT PACKAGE: 50

**BMW (Cont.)**



**13221**  
(0712-9-925-706)  
Plated

"U" Type Nut  
2.9mm Screw Size  
Panel Range: .5mm-1.5mm  
Center of Hole To Edge: 6mm  
UNIT PACKAGE: 50



**13223**  
(BMW:0712-9-925-708;  
Mercedes: 000-994-25-45)  
Plated

"U" Type Nut  
4.2mm (#8) Screw Size  
Panel Range: 3mm -4mm  
Center of Hole to Edge: 7mm  
UNIT PACKAGE: 50



**13216**  
Zinc

"U" Type Nut  
4.8mm Screw Size  
Panel Range: .9mm -2mm  
Center of Hole to Edge: 8mm  
UNIT PACKAGE: 25



**13218**

(BMW: 0712-9-925-737;  
Mercedes: 000-994-06-45)  
Plated

"U" Type Nut  
4.8mm Screw Size  
Panel Range: .5mm-1.7mm  
Center of Hole to Edge: 7mm  
UNIT PACKAGE: 50



**13215**

(BMW: 0711-9-916-945;  
Mercedes: 000-994-14-45)  
Plated

"U" Type Nut  
4.8mm Screw Size  
Panel Range: .8mm -1.7mm  
Center of Hole To Edge: 11mm  
UNIT PACKAGE: 50

**BMW (Cont.)**



**13162**  
(0712-9-925-720)  
Plated

"U" Type Nut  
5.6mm Screw Size  
Panel Range: 1.2mm -2.0mm  
Center of Hole To Edge: 10mm  
UNIT PACKAGE: 50



**13222**

(Mercedes: 000-994-50-45;  
BMW: 0712-9-925-730;  
VW: N15.457.1;  
Opel: 20-72-175)  
Plated

"U" Type Nut  
6.5mm Screw Size  
Panel Range: .7mm-1.5mm  
Center of Hole To Edge: 13mm  
UNIT PACKAGE: 50

**FIAT**



**13196**

(4-40-13-10)  
Red Nylon

Moulding Clip  
UNIT PACKAGE: 50



**16113**

(4-39-58-81)  
Nylon

Moulding Clip  
16mm Wide  
31mm Long  
UNIT PACKAGE: 25

**FIAT (Cont.)**



**13197**  
(14-20-23-83 L125)  
Nylon

Push-In-Nut

UNIT PACKAGE: 50



**13198**

(4-29-29-06)  
Black Nylon

Interior Trim Retainer  
Head Dia: 16mm (41/64")  
Stem Dia: 9mm (11/32")  
Stem Length: 18mm (11/16")

UNIT PACKAGE: 50

**GERMAN MADE  
FORD CLIPS  
& FASTENERS**



**12639**

Nylon

Body Side  
Moulding Clip  
w/Sealer

UNIT PACKAGE: 25

# HONDA CLIPS & FASTENERS

**Sec. 22**

FasTrack®  
Auveco's Cost  
Recovery System  
For Repair Fasteners.

Never Lose Money On  
Fasteners Again.



**19226**  
(90157-SP0-901)  
Nylon

Front Grille Clip  
Acura Legend Coupe  
1991 - On  
Honda Odyssey 1995 - On

UNIT PACKAGE: 15



**17195**  
(Isuzu: 8942180270)  
Black Nylon

Grille Clip  
13mm Wide  
22mm Long  
Ford Escort, Honda,  
Isuzu, Mitsubishi & Plymouth Laser

UNIT PACKAGE: 25

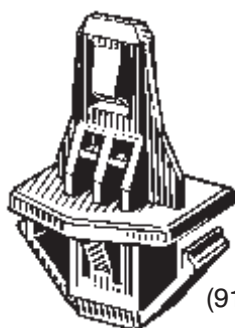

**18457**  
(91578-SV4-003)  
Nylon

Radiator  
Grille Clip  
Accord  
1994-On

UNIT PACKAGE: 5



**19439**  
(90116-S82-A01)  
Nylon

Left Rear Bumper  
Fascia Clip  
Accord  
1998-On

UNIT PACKAGE: 5



**12576**  
(90665-SA0-9700)  
Nylon

Side Protector Moulding Clip  
20mm Wide  
41mm Long  
Snaps Into 8mm Hole

UNIT PACKAGE: 10



**20603**  
(Honda:  
71592-S5D-000)  
White Nylon

Bumper Retainer  
With Sealer  
Head Size: 20mm x 23mm x 15mm  
Stem Length: 22mm  
2001 - On

UNIT PACKAGE: 15

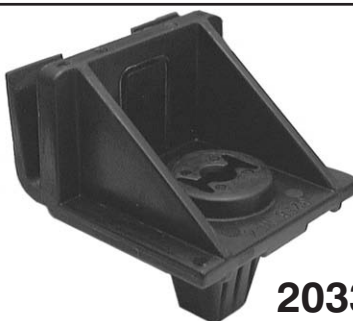

**20331**  
(90108-SS0-003)  
Black Nylon

Bumper Clip  
35mm Wide  
38mm High  
Use with #8 Screw  
Accord  
1998 - On

UNIT PACKAGE: 5



**20677**  
(71598-S30-013)  
Black Nylon

Rear Bumper Moulding Clip  
With Sealer  
Width: 34mm  
Length: 30mm  
Overall Height: 31mm  
Accord  
1998 - On

UNIT PACKAGE: 5

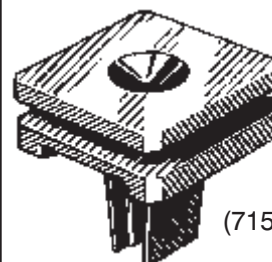

**18200**  
(71593-SM4-0030)  
Nylon

Bumper Retainer  
Accord 1992-On

UNIT PACKAGE: 5



**18415**  
(71144-SR3-A00)  
Natural Nylon

Bumper Grommet  
Civic  
1993-On

UNIT PACKAGE: 25



**19150**  
(91509-SM4-000)  
Natural Nylon

Bumper Grommet  
Accord  
1993-90

UNIT PACKAGE: 10



**15997**  
(34355-SD2-003)  
Nylon

Side Marker Clip  
Accord  
1986-On

UNIT PACKAGE: 25

**Sec. 22****HONDA CLIPS & FASTENERS****14306**(90675-692-0031)  
NylonBody Side  
Moulding Clip  
18mm Wide 15mm Long  
Snaps Into 10mm Hole

UNIT PACKAGE: 25

**14308**(90679-692-0030)  
NylonBody Side Moulding Clip  
10mm Wide; 12mm Long  
Snaps Into 10mm Hole

UNIT PACKAGE: 25

**17443**(91534-SE0-000)  
NylonBody Side Moulding Clip  
Accord 1986-On

UNIT PACKAGE: 25

**17270**(72413-SF1-0030)  
NylonMoulding Clip  
Prelude  
1988-On

UNIT PACKAGE: 15

**19737**(91515-SR4-003)  
Red NylonSide Moulding Clip  
Civic  
1995 - 92

UNIT PACKAGE: 10

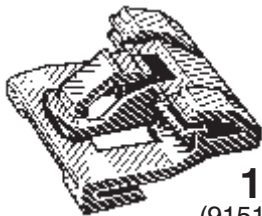
**17981**(91510-SR3-003)  
NylonBelt Moulding Clip  
Civic  
1992-On

UNIT PACKAGE: 10

**20272**(91589-SV4-003)  
Red NylonBelt Moulding Clip  
Width: 20mm  
Length: 24mm  
Accord  
1994 - On

UNIT PACKAGE: 25

**17442**(90601-SH3-014)  
NylonDoor Belt Moulding Clip  
Civic  
1988-On

UNIT PACKAGE: 10

**20340**(91501-S5D-A01)  
White NylonDoor Moulding Clip  
27mm Wide 40mm Long  
Civic  
2001 - On

UNIT PACKAGE: 15

**19359**(91531-ST0-003)  
NylonDoor Moulding Clip  
Civic  
2, 3 & 4 Door  
1995-On

UNIT PACKAGE: 10

**19415**(91527-SM4-003, 91527-SZ3-003,  
91561-S84-A01)  
White NylonBelt Moulding Clip  
Accord & Odyssey  
1990-On

UNIT PACKAGE: 10

**19740**(90666-SSO-003)  
White NylonRoof Moulding Clip  
Acura Integra & Legend  
Honda Prelude  
1992 - On

UNIT PACKAGE: 10

**19680**(91501-SM5-A00)  
Gray NylonRoof Moulding Clip  
Odyssey  
1995 - On

UNIT PACKAGE: 10

**17096**(91513-SM4-000)  
NylonRocker Panel  
Moulding Clip  
20mm Wide  
20mm Long  
Fits Into 12mm Hole  
Accord 1991-On

UNIT PACKAGE: 10

# HONDA CLIPS & FASTENERS

Sec. 22



**18455**  
(91509-SR3-003)  
Nylon

Sash Garnish Clip  
Civic 1993-On

UNIT PACKAGE: 10



**17473**  
(90611-SF1-003)  
Nylon

Quarter Window  
Moulding Clip  
Prelude  
1988-On

UNIT PACKAGE: 10

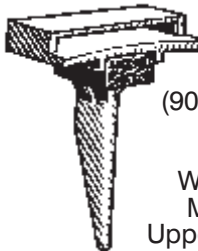

**17320**  
(90612-AF1-003)  
Nylon

Window Reveal  
Moulding Clip  
Upper Quarter Glass  
Prelude  
1988-On

UNIT PACKAGE: 15



**17082**  
(90610-SF1-003)  
Nylon

Rear Pillar  
Garnish Clip  
11mm Wide x 25mm Long  
Fits Into 6mm Hole  
Prelude 1988-On

UNIT PACKAGE: 15



**17089**  
(90605-SF1-003)  
Nylon

Rear Pillar Garnish  
Moulding Clip  
11mm Wide, 25mm long  
Prelude 1988-On

UNIT PACKAGE: 10



**19476**  
(91577-SV4-003)  
Red Nylon

Windshield Left-Hand Corner  
Moulding Clip  
Acura 2.2CL, 2.3CL & 3.0CL;  
Honda Accord & Odyssey  
1994-On

UNIT PACKAGE: 10



**19477**  
(91576-SV4-003)  
Green Nylon

Windshield Right-Hand Corner  
Moulding Clip  
Acura 2.2CL, 2.3CL & 3.0CL;  
Honda Accord & Odyssey  
1994-On

UNIT PACKAGE: 10



**19478**  
(91574-SV2-003)  
Yellow Nylon

Windshield Moulding Clip  
Acura 2.2CL, 2.3CL & 3.0CL;  
Honda Accord  
1994-On

UNIT PACKAGE: 15



**19512**  
(91521-SR3-003)  
Purple Nylon

Windshield Side Moulding Clip  
Civic  
1995 - 92

UNIT PACKAGE: 10



**19513**  
(91519-SR3-003)  
Green Nylon

Windshield Side Moulding Clip  
Civic  
1995 - 92

UNIT PACKAGE: 10

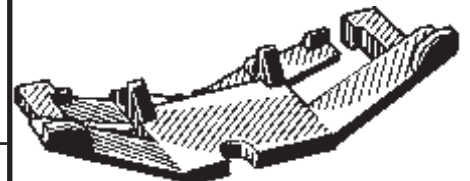

**18405**  
(91562-SV4-003)  
Yellow Nylon

Windshield Side Moulding Clip  
Accord 1994-On

UNIT PACKAGE: 5



**18406**  
(91574-SV4-003)  
White Nylon

Windshield Side Moulding Clip  
Accord 1994-On

UNIT PACKAGE: 5



**18865**

(91529-SS0-003)  
Gray Nylon

Windshield Moulding Clip  
Prelude  
1992-On

UNIT PACKAGE: 15



**19012**

(91531-SM4-003)  
Yellow Nylon

Windshield Upper Moulding Clip  
Accord 2 & 4 Dr. & Station Wagon  
1993-90

UNIT PACKAGE: 10

Not Actual Size



**14685**

(90683-SC6-0030;  
90683-SA6-0030)  
Gray Nylon

Windshield Moulding Clip  
60mm Long, 14mm Wide  
Includes Adhesive  
Mounting Pads

UNIT PACKAGE: 10

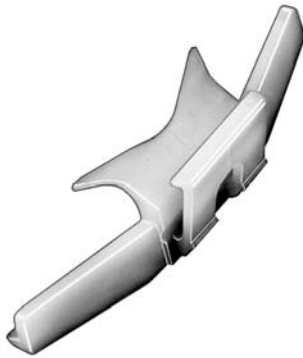

**18866**

(91528-SS0-003)  
White Nylon

Windshield Moulding Clip  
Prelude  
1992-On

UNIT PACKAGE: 15

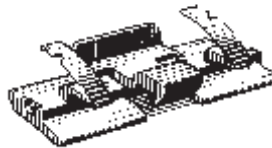

**12580**

(90674-692-0030)  
Black Nylon

Windshield Moulding Clip  
34mm Long, 16mm Wide  
Includes Adhesive  
Mounting Pads

UNIT PACKAGE: 10

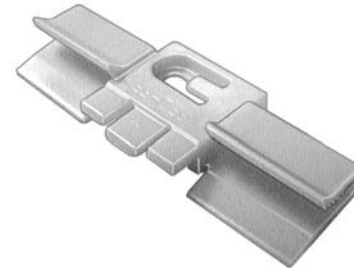

**19223**

(91511-SR2-004)  
Yellow Nylon

Windshield  
Side Moulding Clip  
Del Sol  
1993-On

UNIT PACKAGE: 10



**14701**

(90658-SB0-0030)  
Black Nylon

Windshield Moulding Clip  
34mm Long, 17mm Wide  
Includes Adhesive  
Mounting Pads

UNIT PACKAGE: 10



**18864**

(91530-SS0-003)  
Black Nylon

Windshield Moulding Clip  
Prelude 1992-On

UNIT PACKAGE: 15

**FasTrack®**  
Auveco's Cost  
Recovery System  
For Repair Fasteners...  
Never Lose Money On  
Fasteners Again!



**17285**

(91525-SM4-003)  
Pink Nylon

Windshield Side Moulding Clip  
**Use With 17286**  
Accord 1990-On

UNIT PACKAGE: 15

# HONDA CLIPS & FASTENERS

**Sec. 22**



**20385**  
(91519-S5P-A01)  
Blue Nylon

Windshield Moulding Clip  
17mm Wide, 65mm Long  
Upper Area Of Windshield  
Civic Coupe  
2001 - On

UNIT PACKAGE: 10



**20387**  
(91519-S5A-003)  
Black Nylon

Windshield Moulding Clip  
17mm Wide, 50mm Long  
Upper Area Of Windshield  
Civic Coupe  
2001 - On

UNIT PACKAGE: 10



**20386**  
(91520-S5A-003)  
White Nylon

Windshield Moulding Clip  
23mm Wide, 63mm Long  
Lower Area Of Windshield  
Civic Sedan  
2001 - On

UNIT PACKAGE: 10

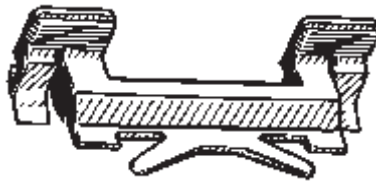

**17286**  
(91524-SM4-A11)  
Yellow Nylon

Windshield Side Moulding Clip  
**Use With 17285**  
Accord 1990-On

UNIT PACKAGE: 15



**17474**  
(91511-SR3-003)  
Orange Nylon

Windshield Side Moulding Clip  
**Use With 17475**  
Civic 1992-On

UNIT PACKAGE: 15



**19670**  
(91541-SM4-003,  
91542-SP0-003)  
Aqua Nylon

Rear Window  
Adjustable Moulding Clip  
Accord  
1990 - On

UNIT PACKAGE: 10

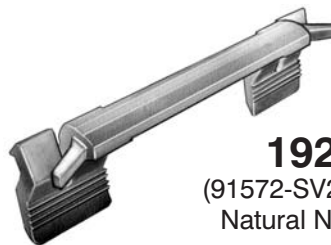

**19224**  
(91572-SV2-003)  
Natural Nylon

Windshield  
Side Moulding Clip  
Honda Accord 1997-94

UNIT PACKAGE: 10



**17475**  
(91520-SR3-003)  
Red Nylon

Windshield Side Moulding Clip  
**Use With 17474**  
Civic 1992-On

UNIT PACKAGE: 15



**20384**  
(91521-S5P-003)  
Green Nylon

Windshield Moulding Clip  
13mm Wide, 53mm Long  
Lower Area Of Windshield  
Civic Coupe  
2001 - On

UNIT PACKAGE: 10



**18403**  
(91573-SV4-003)  
Teal Nylon

Windshield Side Moulding Clip  
**Use With 17326**  
Accord 1994-On

UNIT PACKAGE: 10

All Items Are  
Available In Bulk.  
Call For A  
Quotation.



**18404**

(91572-SV4-003)  
Pink Nylon

Windshield Side Moulding Clip  
**Use With 17324**  
Accord 1994-On

UNIT PACKAGE: 10



**14705**

(90713-SB0-003)  
Black Nylon

Quarter Window  
Moulding Clip  
18mm Long  
18mm Wide  
Snaps Into 5mm Hole

UNIT PACKAGE: 25



**14700**

(90672-SA6-0030)  
Black Nylon

Windshield Moulding Clip  
35mm Long  
14mm Wide

UNIT PACKAGE: 25

**Please Order  
In Unit Package  
Quantities Not  
Pieces**



**14703**

(90673-SC6-0030)  
White Nylon

Windshield Moulding Clip  
35mm Long  
14mm Wide

UNIT PACKAGE: 25



**15472**

(90664-SB0-004)  
Black Nylon

Windshield Moulding Clip  
11mm Wide, 35mm Long  
Honda 1983-On

UNIT PACKAGE: 15



**17454**

(74807-SB0-004)  
Black Nylon

Rear Window Moulding Clip  
1983-On

UNIT PACKAGE: 25



**15474**

(90674-SC6-003)  
Black Nylon

Back Glass Moulding Clip  
15mm Wide, 38mm Long  
Honda Accord 1984-On

UNIT PACKAGE: 15



**17280**

(91505-SG0-003)  
Orange Nylon

Windshield Moulding Clip  
Prelude 1988-On  
Acura Legend 1988-On

UNIT PACKAGE: 15



**17281**

(90694-SB0-003)  
Black Nylon

Windshield Moulding Clip  
Prelude 1983-On

UNIT PACKAGE: 15



**17282**

(91534-SM4-003)  
White Nylon

Windshield Moulding Clip  
Accord 1990-On  
Acura Legend 1991-On

UNIT PACKAGE: 10



# HONDA CLIPS & FASTENERS

**Sec. 22**

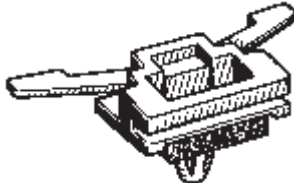

**17321**  
(90606-SF1-003)  
White Nylon

Window Reveal Moulding Clip  
Lower Quarter Glass  
Prelude 1988-On

UNIT PACKAGE: 10

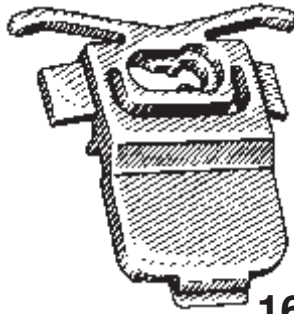

**16861**  
(90664-692-0300)  
Black Nylon

Windshield Reveal Moulding Clip  
40mm Wide, 40mm Long  
Prelude 1979-On

UNIT PACKAGE: 25

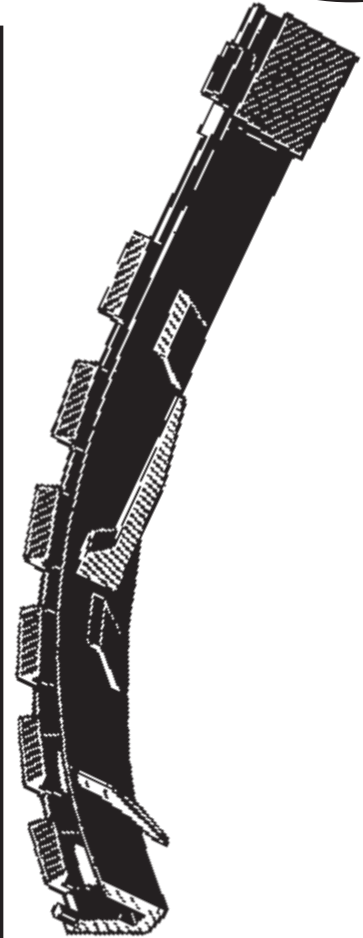

**17488**  
(73156-SS0-004)

Window Moulding Clip  
Left-Hand Corner  
Prelude  
1992-On

UNIT PACKAGE: 5



**19115**  
(91528-S01-A01)  
Blue Nylon

Drip Moulding Clip  
4 Door Civic  
1995-On

UNIT PACKAGE: 15

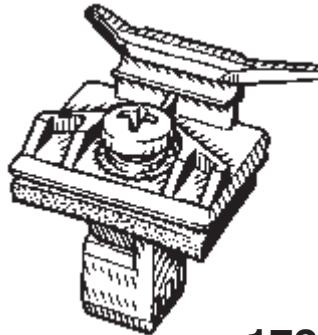

**17203**  
(91526-SM4-004)  
Black Nylon  
w/ Stainless Steel Screw

Windshield & Rear Window  
Holder Clip  
Accord 1990-On

UNIT PACKAGE: 5



**16825**  
(74806-SB6-003)  
White Nylon

Back Glass Moulding Clip  
33mm Wide, 30mm Long  
Snaps Into 6mm Hole  
Civic, Hatchback 1984-On

UNIT PACKAGE: 25

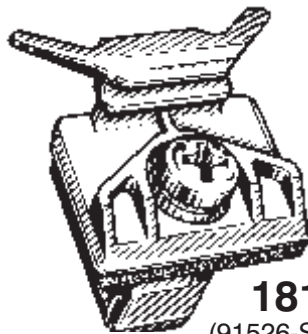

**18112**  
(91526-SM2-004)  
Gray Nylon  
w/ Stainless Steel Screw

Rear Window Holder Clip  
Honda Accord Coupe  
1990-On

UNIT PACKAGE: 5



**14288**  
(90655-SA0-0030)  
Natural Nylon

#6 Screw Size  
9.5mm Wide; 9.5mm Long  
Snaps Into 6mm x 6mm Hole

UNIT PACKAGE: 50



**14317**  
(34301-692A-0000)  
White Nylon

#8 Screw Size  
9.5mm Wide; 9.5mm Long  
Snaps Into 6mm x 6mm Hole

UNIT PACKAGE: 50

Remember...  
All Items In This  
Catalog  
Are Available In Bulk.

Call For A Quote.



**14255**

(Honda: 75522-611-0000;  
Mazda: 9991-00-412;  
Mitsubishi: MS-480001)  
Black Nylon

#8 Screw Size  
9.5mm Wide, 9.5mm Long  
Snaps Into 7mm x 7mm Hole

UNIT PACKAGE: 50



**14287**

(90656-671-6310M1)  
Natural Nylon

#14 (1/4") Screw Size  
13mm Wide, 15mm Long  
Snaps Into 8.5mm x 10.5mm Hole

UNIT PACKAGE: 50



**19117**

(91619-SM4-003,  
91619-SM4-0030)  
Natural Nylon

Center Pillar Garnish  
Moulding (Oval) Screw Grommet  
#4 Screw Size  
Odyssey & Accord Wagon  
1991-On

UNIT PACKAGE: 25

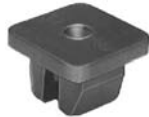

**20350**

(90866-SAO-000)  
Natural Nylon

Door Trim  
Nylon Nut  
#4 Screw Size  
Head Size: 13mm x 13mm  
Stem Length: 7mm  
Civic  
1998 - On

UNIT PACKAGE: 25



**14294**

(90675-SA6-0030)  
Natural Nylon

Screw Grommet  
With Sealer  
#6 Screw Size  
15mm Wide, 15mm Long  
Stem Length: 12mm  
Snaps Into 7mm x 7mm Hole

UNIT PACKAGE: 15



**14313**

(Honda:  
90662-671-0030;  
Mazda: 9991-00-503;  
Nissan: 68425-H5000)  
Natural Nylon

#10 Screw Size  
17mm Wide  
17mm Long  
Snaps Into 8mm x 8.5mm Hole  
Also For Mazda & Nissan

UNIT PACKAGE: 25



**20351**

(90666-SD9-000)  
Natural Nylon

Nylon Nut  
#14 (M6.3) Screw Size  
Head Size: 16mm x 16mm  
Stem Length: 8mm  
CR-V  
1997 - On

UNIT PACKAGE: 25



**14296**

(90668-688-0030)  
Natural Nylon

Screw Grommet  
With Sealer  
#6 Screw Size  
11mm Wide, 14mm Long  
Stem Length: 10mm  
Snaps Into 7mm x 10mm Hole

UNIT PACKAGE: 25



**17609**

(91635-SM4-003)  
Black Nylon

Headlight To Grille  
Spacer Bracket Grommet  
#10 Screw Size  
Honda Accord  
1990-On

UNIT PACKAGE: 10

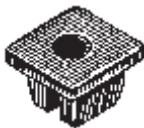

**17058**

(90676-SA7-003)  
Natural Nylon

Headlight Adjusting  
Screw Nut  
M5-.8 Screw Size  
Prelude & Accord 1986-On

UNIT PACKAGE: 25



**14274**

(Honda: 75521-611-0000;  
Mazda: 9991-00-601;  
Nissan: 96706-P0105  
Toyota: 90189-06010)  
Natural Nylon

#10 Screw Size  
13mm Wide, 13mm Long  
Snaps Into 8.5mm x  
8.5mm Hole

UNIT PACKAGE: 25



**20445**

(91637-SE3-003)  
Natural Nylon

Trim Pillar Garnish  
Screw Grommet  
M3.5 (#6) Screw Size  
Head Size: 13mm x 17  
CRV  
1997 - On

UNIT PACKAGE: 15



**20612**  
(90603-S7S-003)  
Blue Nylon  
With Sealer

Cowl Vent Grommet  
Flange Size: 10mm x 24mm  
Stem Length: 6mm  
**Use With Auveco 20611**  
Honda Accord  
2003 - On

UNIT PACKAGE: 15



**14280**  
(90681-693-0000)  
Natural Nylon

Screw Grommet  
#6 Screw Size  
10mm Wide 17mm Long  
Stem Length: 15mm  
Fits Into 7mm x 13mm Hole

UNIT PACKAGE: 25



**14690**  
(Honda: 90683-693-0000;  
Nissan: 78856-R4301)  
White Nylon

Screw Grommet  
#10 Screw Size  
12mm Wide  
19mm Long  
Stem Length: 17mm  
Fits Into 8mm x 15mm Hole

UNIT PACKAGE: 25



**19679**  
(91641-SH3-013)  
Yellow Nylon  
w/ Steel Insert

Garnish Moulding Grommet  
Head Diameter: 14mm x 26mm  
Acura Integra, Honda Civic  
& Prelude  
1988 - On

UNIT PACKAGE: 10



**19307**  
(91620-SR2-003)  
Natural Nylon

Center Pillar  
Screw Grommet  
#4 Screw Size  
Del Sol  
1993-On

UNIT PACKAGE: 10



**19646**  
(90665-SM4-000)  
Yellow Nylon

Front Door  
Screw Grommet  
#6 Screw Size  
Head Diameter: 14mm  
Stem Length: 10mm  
Fits Into 7mm x 7mm Hole  
Prelude  
1997 - On

UNIT PACKAGE: 15



**14268**  
(Honda: 90672-671-8110M1;  
Toyota: 90189-04013)  
White Nylon

Screw Grommet  
#6 Screw Size  
Head Diameter: 14mm  
Stem Length: 15mm  
Fits Into 7mm x 7mm Hole

UNIT PACKAGE: 25



**14281**  
(Honda: 90662-693-0030;  
Toyota: 9018-04066)  
White Nylon

Screw Grommet  
#6 Screw Size  
Head Diameter: 14mm  
Stem Length: 10mm  
Fits Into 7mm x 7mm Hole

UNIT PACKAGE: 25



**19741**  
(90670-SG0-003,  
91626-SH3-003)  
Natural Nylon

Door Panel Screw Grommet  
#8 (M4.2) Screw Size  
Head Diameter: 12mm  
Stem Length: 16mm  
Fits Into 7mm x 7mm Hole  
Civic & CRV  
1993-On

UNIT PACKAGE: 15



**14695**  
(Honda: 90661-SC7-0030;  
Mazda: H001-50-841;  
Mitsubishi: MS-480012;  
Nissan: 01651-00481,  
01651-00481,  
74798-S9000;  
Toyota: 90189-06042)  
White Nylon

Screw Grommet  
#8 Screw Size  
Head Diameter: 16mm  
Stem Length: 17mm  
Fits Into 8mm x 8mm Hole

UNIT PACKAGE: 25



**20303**  
(90664-SB3-003)  
Natural Nylon

Trim Panel  
Screw Grommet  
#8 (M4.2) Screw Size  
Head Diameter: 15mm  
Stem Length: 15mm  
Fits Into 8mm x 8mm Hole  
Accord  
1998 - On

UNIT PACKAGE: 10



**19650**  
(90106-SW3-003)  
White Nylon

Bumper Grommet  
Head Size: 18mm x 20mm  
Stem Length 19mm  
Fits Into 8mm x 11mm Hole  
Accord, Odyssey  
& Prelude  
1995 - On

UNIT PACKAGE: 10



**19143**  
(91623-SM2-0030)  
Natural Nylon

Door Glass  
Guide Grommet  
#6 Screw Size  
Prelude &  
2 Door Accord  
1990-On

UNIT PACKAGE: 10



**19454**  
(90651-SL9-0130)  
Gray Nylon

Rear Bumper Fascia  
Grommet  
Accord  
1996 - 94

UNIT PACKAGE: 15



**19734**  
(90107-SX0-003)  
Black Nylon

Bumper Grommet  
#10 Screw Size  
Acura 2.2CL, 2.3CL, 2.5TL, 3.2TL,  
3.5RL;  
Honda Accord & Prelude  
1996 - On

UNIT PACKAGE: 15



**20304**  
(91561-SE3-003)  
Green Nylon

Trim Panel  
Screw Grommet  
#10 (M4.8) Screw Size  
Stem Length: 10mm  
Fits Into 8mm x 8mm Hole  
Accord  
1998 - On

UNIT PACKAGE: 25



**19533**  
(90107-S10-003)  
Black Nylon

Wheel Well Moulding  
Screw Grommet  
#10 Screw Size  
CR-V  
1997 - On

UNIT PACKAGE: 25



**20472**  
(91512-SR3-004)  
White Nylon

Tubular Nut  
With Sealer & Sealed End  
3mm Stud Size  
Head Dia: 8.5mm  
Fits Into 6mm Hole  
Emblem Nut  
Acura Integra,  
Honda Accord, Civic, CRV  
& Prelude  
1994 - On

UNIT PACKAGE: 10

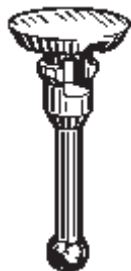

**17283**  
(90655-SB2-003)  
Nylon

Vent Cowl & Interior  
Trim Panel Retainer  
Civic 1984-On

UNIT PACKAGE: 25



**18115**  
(90676-SR4-003)  
Nylon

Reveal Moulding  
Pin Retainer  
**Use With 18116**  
Civic 1993-On

UNIT PACKAGE: 15



**14291**  
(66435-648-0000)  
Black Nylon

Retaining Clip  
Head Diameter: 11mm  
Stem Length: 13mm  
Snaps Into 5mm Hole  
Panel Thickness: 5mm

UNIT PACKAGE: 50



**14282**  
(90687-SA5-0030)  
Black Nylon

Retaining Clip  
Head Diameter: 13mm  
Stem Length: 15mm  
Snaps Into 5mm Hole  
Panel Thickness: 4mm

UNIT PACKAGE: 50



**18157**  
(90672-671-003)  
Gray Nylon

Headliner & Cowl Grille  
Retaining Clip  
Head Diameter: 13mm  
Stem Length: 16mm  
Panel Thickness: 5mm  
Fits Into 5mm Hole  
Accord 1986-On

UNIT PACKAGE: 25



**20381**  
(Honda: 90667-671-013ZA;  
Mitsubishi: MC440901;  
Nissan: 62660-48600-1)  
Black Nylon

Trim Panel Retaining Clip  
Head Diameter: 16mm  
Stem Diameter: 7mm  
Stem Length: 16mm  
Honda, Mitsubishi & Nissan

UNIT PACKAGE: 25

# HONDA CLIPS & FASTENERS

**Sec. 22**



**20334**

(90667-SOD-003ZC)  
Gray Nylon

Trunk Garnish Retainer  
Head Dia: 18mm  
Stem Dia: 7.5mm Sq.  
Stem Length: 20mm  
Civic  
1998 - On

UNIT PACKAGE: 15



**19506**

(90666-SA7-003ZW)  
Black Nylon

Trunk Lining Retainer  
Head Diameter: 16mm  
Stem Diameter: 5mm Square  
Stem Length: 16mm  
Acura 2.5TL, 3.2TL, 3.5,  
Integra & Legend,  
Honda Accord Wagon  
& Prelude  
1987 - On

UNIT PACKAGE: 15



**19674**

(90671-SB3-003YF)  
Gray Nylon

Headliner Retainer  
Head Diameter: 19mm  
Stem Diameter: 6mm Sq.  
Stem Length: 10mm  
CRV  
1998 - On

UNIT PACKAGE: 15



**16781**

(Honda: 90670-692-0030;  
Toyota: 90467-09065)  
Black Nylon

Retaining Clips  
Head Dia: 15mm  
Stem Length: 20mm  
Panel Thickness: 11mm  
Fits Into 7mm Hole

UNIT PACKAGE: 25



**19744**

(90669-SP0-003ZA)  
Black Nylon

Trunk Trim Retainer  
Head Diameter: 16mm  
Stem Diameter: 6mm  
Stem Length: 27mm  
Civic  
1998 - On

UNIT PACKAGE: 10

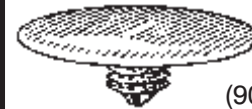

**15998**

(90700-SB2-003)  
Black Nylon

Hood Insulation Retainer  
Head Dia: 30mm  
Stem Length: 9mm  
Fits Into 6mm Hole  
Honda Prelude 1985-On

UNIT PACKAGE: 15



**14289**

(90666-SA0-0030)  
Black Nylon

Retainer  
Head Diameter: 13mm  
Stem Length: 16mm  
Snaps Into 5mm Hole

UNIT PACKAGE: 25

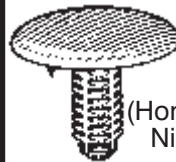

**16775**

(Honda: 90667-SA7-0030;  
Nissan: 89427-98070)  
Black Nylon

Trim Panel Retainer  
Head Dia: 20mm  
Stem Length: 15mm  
Fits Into 5mm Hole

UNIT PACKAGE: 25



**18746**

(90700-SJ4-000)  
Black Nylon

Hood Insulation Retainer  
Head Diameter: 30mm  
Stem Diameter: 10mm  
Stem Length: 6mm  
Acura Legend 1991 - On  
Honda 1998 - On

UNIT PACKAGE: 15



**19470**

(90108-SW3-003)  
Black Nylon

Bumper Retainer  
Head Diameter: 16mm  
Stem Diameter: 4mm  
Stem Length: 21mm  
Accord,  
Odyssey & Prelude  
1995-On

UNIT PACKAGE: 15



**16776**

(Honda: 90667-SAO-0030;  
Nissan: 76996-01P02)  
Black Nylon

Trim Panel Retainer  
Head Dia: 18mm  
Stem Length: 20mm  
Fits Into 6mm Hole

UNIT PACKAGE: 25



**20609**

(91501-S1K-003)  
Black Nylon

Hood Insulation Retainer  
Head Diameter: 30mm  
Stem Diameter: 15mm x 20mm  
Stem Length: 14mm  
Acura 3.5RL & RSX And  
Honda Civic & CR-V  
2000 - On

UNIT PACKAGE: 25



**14316**

(90676-671-0030)  
Black Nylon

Trim Fastener  
Head Diameter: 18mm  
Stem Length: 12mm  
Fits Into 9mm x 11mm Hole

UNIT PACKAGE: 25

**Sec. 22****HONDA CLIPS & FASTENERS****18114**(91520-SM4-C010)  
Black NylonHood Insulation Retaining Clip  
Head Diameter: 10mm  
Stem Length: 10mm  
Panel Thickness: 4mm  
Fits Into 6mm Hole  
Honda & Acura 1990-On  
UNIT PACKAGE: 25**14323**(38529-689A-6300)  
Black NylonRetaining Clip  
Head Diameter: 18mm  
Stem Length: 15mm  
Snaps Into 7mm Hole  
Panel Thickness: 4mm  
UNIT PACKAGE: 25**20611**(90602-S7S-003)  
Blue NylonCowl Vent Retainer  
Top Head Diameter: 12mm  
Bottom Head Diameter: 16mm  
Stem Diameter: 3mm  
Stem Length: 7mm  
**Use With Auveco 20612**  
Accord  
2003 - On  
UNIT PACKAGE: 25**19682**(91518-S10-003)  
Black NylonHood Seal Retaining Clip  
Head Diameter: 11mm  
Stem Length: 8mm  
Fits Into 6mm Hole  
Odyssey  
1999 - On  
UNIT PACKAGE: 25**16779**(Honda: 74842-659-0030;  
Toyota: 90467-12078)  
Black NylonRetaining Clip  
Head Dia: 18mm  
Stem Length: 15mm  
Panel Thickness: 6mm  
Fits Into 8mm Hole  
UNIT PACKAGE: 25**19145**(91560-SP0-003)  
Gray NylonFront & Rear Door  
Trim Panel Retainer  
Small Head Dia: 13mm  
Large Head Dia: 17mm  
Stem Diameter: 9mm  
Stem Length: 12mm  
Acura Integra & Legend  
Honda Accord, Civic,  
Prelude, Odyssey & Del Sol  
1991-On  
UNIT PACKAGE: 25**19114**(91518-SM4-003)  
Black NylonHood & Trunk Moulding  
Retaining Clip  
Head Diameter: 12mm  
Stem Length: 9mm  
Fits Into 6mm Hole  
Acura Integra & Honda Civic  
1994 - On  
UNIT PACKAGE: 10**14319**(90687-671-0030)  
Black NylonRetaining Clip  
Head Diameter: 20mm  
Stem Length: 20mm  
Snaps Into 10mm Hole  
Panel Thickness: 6mm  
UNIT PACKAGE: 25**20411**(91560-S84-A11)  
Black NylonWindshield Garnish  
Pillar Retainer  
Top Head Dia: 13mm  
Middle Head Dia: 16mm  
Bottom Head Dia: 14.5mm  
Stem Diameter: 9.5mm  
Stem Length: 12mm  
Acura 3.2CL, Honda Accord,  
Insight & Odyssey  
1998 - On  
UNIT PACKAGE: 15**17205**(91501-SM4-003)  
Black NylonCowl Top Retaining Clip  
Head Dia: 14mm  
Stem Length: 15mm  
Fits Into 6mm Hole  
Accord 1990-On  
UNIT PACKAGE: 15**19229**(8-94215-211-0)  
Black NylonFender Mud Skirt  
Retainer  
Acura SLX 1996-On  
Honda Passport 1995-93  
UNIT PACKAGE: 15**20610**(Honda:  
91560-SM4-003)  
White NylonDoor Trim Panel Retainer  
Top Head Diameter: 13mm  
Middle Head Diameter: 18mm  
Bottom Head Diameter: 16mm  
Stem Diameter: 9mm  
Stem Length: 15mm  
Accord  
1990 - On  
UNIT PACKAGE: 25



**18294**  
(91566-SP0-003)  
White Nylon

Trim Panel Retainer  
Small Head Dia: 13mm  
Large Head Dia: 18mm  
Stem Length: 14mm  
Fits Into 9mm Hole  
Honda 1990-On  
UNIT PACKAGE: 15



**18818**  
(91513-SE0-003)  
Natural Nylon

Hood Seal Retainer  
Head Size: 7mm x 16mm  
Stem Length: 12mm  
Fits Into 5mm Hole  
Accord & Prelude  
1983-On  
UNIT PACKAGE: 25



**19683**  
(91502-S84-A11)  
Black Nylon

Cowl Vent  
Retaining Clip  
Head Diameter: 6mm x 16mm  
Stem Length: 14mm  
Fits Into 6mm Hole  
Odyssey  
1999 - On  
UNIT PACKAGE: 15



**14299**  
(73862-672-0030)  
White Nylon

Weatherstrip Retainer  
7mm Wide  
16mm Long  
Stem Length: 5mm  
Fits Into 5mm Hole  
UNIT PACKAGE: 50



**18877**  
(91530-SP1-003)  
Orange Nylon

Weatherstrip Retainer  
Head Size: 5mm x 15mm  
Stem Length: 10mm  
Fits Into 6mm Hole  
Acura 3.5 RL & Honda  
Accord, Civic & Odyssey  
1992-On  
UNIT PACKAGE: 25



**19483**  
(91515-SR3-000)  
Black Nylon

Rear Hood Cowl  
Weatherstrip Retaining Clip  
Head Size: 8mm x 18mm  
Stem Length: 15mm  
Fits Into 7mm Hole  
Acura Integra, Honda Civic, CR-V  
& Del Sol  
1992 - On  
UNIT PACKAGE: 25



**14328**  
(90664-671-0030)  
White Nylon

Weatherstrip Retainer  
7mm Wide  
16mm Long  
Stem Length: 10mm  
Fits Into 5mm Hole  
UNIT PACKAGE: 50



**19116**  
(91530-ST5-003)  
Natural Nylon

Weatherstrip Retainer  
Head Size: 5mm x 15mm  
Stem Length: 10mm  
Fits Into 6mm Hole  
Front & Rear Doors  
Civic  
1995 - On  
UNIT PACKAGE: 10



**19544**  
(91512-SJ6-J01)  
Black Nylon

Retaining Clip  
Head Size: 9mm x 12mm  
Stem Length: 9mm  
Fits Into 7mm Hole  
Holds The Washer Tube Running  
To The Rear Window Behind The  
Door Protector  
CR-V  
1997 - On  
UNIT PACKAGE: 25



**19673**  
(72311-S10-003)  
Black Nylon

Weatherstrip Retainer  
Head Size: 10mm x 15mm  
Stem Diameter: 5mm  
Stem Length: 10mm  
CRV  
1997 - On  
UNIT PACKAGE: 15



**19171**  
(91568-SR2-003)  
Green Nylon

Weatherstrip Retainer  
Head Size: 5mm x 15mm  
Stem Length: 10mm  
Fits Into 5mm Hole  
Odyssey  
1995 - On  
UNIT PACKAGE: 100



**14290**  
(90692-SA5-0030)  
Black Nylon

Niflock Rivet  
Diameter: 5mm  
Head Diameter: 12mm  
Stem Length: 17mm  
UNIT PACKAGE: 25

**Sec. 22****HONDA CLIPS & FASTENERS**

**14293**  
(90674-SA5-0030)  
Black Nylon  
Niflock Rivet  
Diameter: 6mm  
Head Diameter: 11mm  
Stem Length: 23mm

UNIT PACKAGE: 25



**14286**  
(90673-692-0030)  
Black Nylon  
Push-Type Retainer  
15mm Wide  
20mm Long  
Stem Length: 9mm  
Fits Into 8mm x 11.5mm Hole

UNIT PACKAGE: 25

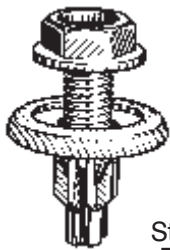

**17350**  
(91516-SK7-013)  
Black Nylon  
Splash Shield  
Push-Type Retainer  
Phillips Drive  
Head Dia: 20mm  
Stem Length: 15mm  
Fits Into 8mm Hole  
10mm Hex  
Civic 1992-On

UNIT PACKAGE: 10



**18119**  
(91502-SP0-003)  
Black Nylon  
Front & Rear Bumper  
Push-Type Retainer  
Head Diameter: 20mm  
Stem Length: 25mm  
Fits Into 10mm Hole  
Honda 1990-On

UNIT PACKAGE: 10



**18165**  
(91508-SR3-000)  
Black Nylon  
Cowl Panel  
Push-Type Retainer  
Head Diameter: 17mm  
Stem Length: 9mm  
Fits Into 8mm Hole  
Honda 1990-On

UNIT PACKAGE: 10



**17192**  
(91508-SM4-003)  
Black Nylon  
Cowl Panel Retainer  
Head Dia: 18mm  
Stem Length: 14mm  
Fits Into 8mm Hole  
Accord 1990-On

UNIT PACKAGE: 10



**19186**  
(90657-SB0-003)  
Black Nylon  
Front Bumper Cover  
Push-Type Retainer  
Head Diameter: 11mm  
Stem Length: 10mm  
Fits Into 8mm Hole  
Acura Legend, Honda Accord &  
Odyssey  
1991-On

UNIT PACKAGE: 10



**19547**  
(91508-S50-003)  
Black Nylon  
Cowl Top Retainer  
Head Diameter: 17mm  
Stem Length: 13mm (Exc. Pin)  
Fits Into 9mm Hole  
Accord & Odyssey  
1998 - On

UNIT PACKAGE: 5



**20247**  
(Mitsubishi: MR200300)  
Black Nylon  
Fender & Bumper  
Push-Type Retainer  
Head Diameter: 18mm  
Stem Length: 12mm  
Fits Into 9mm Hole  
Honda & Mitsubishi  
1998 - On

UNIT PACKAGE: 15



**19453**  
(90505-SX0-003)  
Black Nylon  
Garnish Side Protector  
Push-Type Retainer  
Head Diameter: 18mm  
Stem Length: 15mm  
(Not Including The Pin)  
Fits Into 8mm Hole  
Odyssey  
1995 - On

UNIT PACKAGE: 15



**19118**  
(91501-S04-003)  
Black Nylon  
Push-Type Retainer  
Head Diameter: 20mm  
Stem Length: 10mm  
Fits Into 8mm Hole  
Front Fender  
Civic & Del Sol 1993-On

UNIT PACKAGE: 15



**19233**  
(Acura: 91503-SZ3-003;  
Honda: 91503-SZ5-003)  
Black Nylon  
Front Bumper Push-Type Retainer  
Head Diameter: 20mm  
Stem Length: 13mm  
Fits Into 10mm Hole  
Acura 3.5 RL Sedan & Honda  
1996-On

UNIT PACKAGE: 15



**19239**  
(Honda:  
91512-SX0-003;  
Mitsubishi: MU000319)  
Black Nylon  
Front Fender & Bumper Support  
Push-Type Retainer  
Head Diameter: 20mm  
Stem Length: 11mm  
Fits Into 8mm Hole  
Acura 3.5RL, Honda Accord,  
Prelude & Odyssey  
1994-On  
Mitsubishi Lancer  
2002-On

UNIT PACKAGE: 25



# HONDA CLIPS & FASTENERS

**Sec. 22**



**20608**  
(91503-S0K-A01)  
Black Nylon

Grille Mounting  
Push-Type Retainer  
Head Diameter: 20mm  
Stem Length: 14mm  
Fits Into 10mm Hole  
Element  
2003 - On  
UNIT PACKAGE: 15



**17287**  
(90687-SB0-003,  
90687-SB0-013)  
Black Nylon

Cowl Vent Panel Retainer  
Head Dia: 13mm  
Stem Length: 11mm  
Fits Into 6mm Hole  
Prelude 1983-On  
UNIT PACKAGE: 25



**19142**  
(91550-SH3-003)  
Black Nylon

Pillar Garnish, Side And  
Trunk Lining  
Push-Type Retainer  
Head Diameter: 15mm  
Stem Length: 13mm  
Fits Into 7mm Square Hole  
Civic, Accord Wagon  
& Del Sol  
1993-On  
UNIT PACKAGE: 5



**20564**  
(91503-SZ5-003)  
Black Nylon

Front & Rear Bumper  
Push-Type Retainer  
Head Diameter: 20mm  
Stem Length: 18mm  
Fits Into 10mm Hole  
Acura 3.5RL And  
Honda Accord & Odyssey  
1996 - On  
UNIT PACKAGE: 15



**14697**  
(GM: 94198687;  
Honda: 90657-SA6-0030;  
Mazda: N304-13-356-A)  
Black Nylon

Push-Type Retainer  
Head Dia: 14mm  
Stem Length: 11mm  
Fits Into 7mm Hole  
UNIT PACKAGE: 25



**19546**  
(91570-SK7-003ZF)  
Black Nylon

Tailgate Lining Retainer  
Head Dia.: 17mm  
Stem Length: 16mm  
Fits Into 7mm Square Hole  
Prelude  
1997 - On  
UNIT PACKAGE: 10



**16782**  
(Honda:  
91545-SE0-0030-W1;  
Nissan: 63848-01G00)  
Black Nylon

Push-Type Retainer  
Head Dia: 20mm  
Stem Length: 14mm  
Fits Into 8mm Hole  
UNIT PACKAGE: 25



**14696**  
(Honda: 90684-SA5-0030;  
Isuzu: 8942981190;  
Nissan: 10998-30880)  
Black Nylon

Push-Type Retainer  
Head Dia: 15mm  
Stem Length: 11mm  
Fits Into 6mm Hole  
UNIT PACKAGE: 25



**17081**  
(91524-SE0-003)  
Black Nylon

Cowl Push-Type Retainer  
Head Dia: 18mm  
Stem Length: 12mm  
Fits Into 6mm Hole  
Accord 1986-On  
UNIT PACKAGE: 25



**19416**  
(Toyota: 90467-09139)  
Black Nylon

Bumper Cover & Wheel Housing  
Push-Type Retainer  
Head Diameter: 18mm  
Stem Length: 15mm  
Fits Into 9mm Hole  
Honda, Mazda 626 & Toyota Corolla  
1992-On  
UNIT PACKAGE: 15



**19311**  
(90683-SA5-003)  
Black Nylon

Front Fender Skirt  
Push-Type Retainer  
Head Diameter: 15mm  
Stem Length: 13mm  
Fits Into 6mm Hole  
Prelude  
1996-92  
UNIT PACKAGE: 15



**14698**  
(90688-SB0-003)  
Black Nylon

Push-Type  
Retainer  
Head Dia: 18mm  
Stem Length: 11mm  
Fits Into 6mm Hole  
UNIT PACKAGE: 25

**Sec. 22****HONDA CLIPS & FASTENERS****17057**(90505-SM4-003)  
Black NylonPush-Type Retainer  
Head Dia: 18mm  
Stem Length: 21mm  
Fits Into 8mm Hole  
Accord 1990-On

UNIT PACKAGE: 10

**17144**(91504-SM4-000)  
Black NylonPush-Type Retainer  
Head Diameter: 20mm  
Stem Length: 24mm  
Fits Into 10mm Hole  
Bumper Fascia  
Accord 1990-On

UNIT PACKAGE: 10

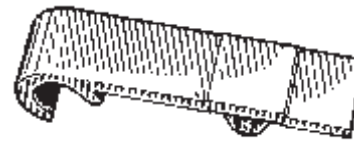
**18512**(91512-SE0-003)  
Gray NylonWindshield Washer Hose Clip  
11mm Wide, 42mm Long  
Holds 6.3mm (1/4") Hose  
Accord 1986-On

UNIT PACKAGE: 15

**16000**(Honda:  
90675-SB3-003;  
Mazda: FB01-56-964;  
Nissan: 63876-95596)  
Black NylonPush-Type Retainer  
Head Dia: 20mm  
Stem Length: 9mm  
Fits Into 8mm Hole

UNIT PACKAGE: 25

**17143**(91502-SM4-000)  
Black NylonPush-Type Retainer  
Head Diameter: 20mm  
Stem Length: 27mm  
Fits Into 10mm Hole  
Bumper Fascia  
Accord 1990-On

UNIT PACKAGE: 10



Not Actual Size

**20432**(91504-SR3-003)  
Black NylonWindshield Washer Hose Clip  
15mm Wide, 66mm Long  
Holds 6.3mm (1/4") Hose  
Accord, Civic,  
CR-V & Del Sol  
1993 - On

UNIT PACKAGE: 10

**20352**(91561-S84-A00-M1)  
Black NylonRear Panel Assembly  
Push-Type Retainer  
Head Diameter: 16mm  
Stem Length: 21mm  
Fits Into 8mm Hole

UNIT PACKAGE: 10

**14688**(91547-SE0-0030)  
NylonHood Prop Rod Clip  
Holds 6mm Prop Rod  
Snaps Into 7mm Hole

UNIT PACKAGE: 25

**17379**(91512-SM4-003)  
Black NylonFender Splash Shield  
Push-Type Retainer  
Head Diameter: 20mm  
Stem Length: 9mm  
Fits Into 8mm Hole  
Accord 1990-On

UNIT PACKAGE: 10

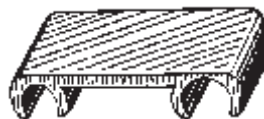
**14321**(17962-SA0-0030)  
NylonTube/Cable Routing Clip  
One Cavity For  
5mm Tubes/Cables &  
One Cavity For  
7mm Tubes/Cables  
33mm Wide  
15mm Long

UNIT PACKAGE: 25

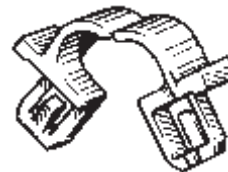
**16949**(90652-SB2-023)  
NylonWindshield Washer  
Hose Retainer  
For 3mm (7/64") I.D.,  
5mm (13/64") O.D. Hose  
Fits Into 7mm (9/32")  
Square Hole  
Honda 1986-On

UNIT PACKAGE: 15

# HONDA CLIPS & FASTENERS

**Sec. 22**

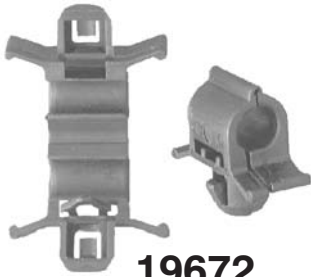

**19672**  
(91558-SE3-003)  
Black Nylon

Wire Clip  
Maximum Wire Dia: 5mm  
For Hood Release Cable,  
Fuel Door Release Cable &  
Sliding Door Lock Cable  
Odyssey Van  
1999 - On

UNIT PACKAGE: 15

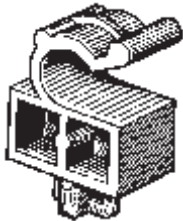

**14687**  
(90677-671-0031)  
Nylon

Hood Prop Rod Clip  
Holds 8mm Prop Rod  
Snaps Into 9mm x 9mm Hole

UNIT PACKAGE: 25



**20330**  
(90602-S84-A01)  
Black Nylon

Hood Prop Rod Clip  
8mm Rod Diameter  
Accord  
1998 - On

UNIT PACKAGE: 10



**16950**  
(90677-SE0-003)  
Nylon

Hood Prop  
Rod Clip  
Holds 8mm Prop Rod  
Accord 1986-On

UNIT PACKAGE: 5



**19730**  
(90654-SA4-003)  
Natural Nylon

Wire Routing Clip  
Holds 6mm Diameter Wire  
Fits Into 7mm Hole  
Civic  
1998 - On

UNIT PACKAGE: 15



**18454**  
(91604-SD2-013)  
Nylon

Hood Prop Rod Grommet  
Civic 1989-On

UNIT PACKAGE: 5



**20329**  
(72175-SH3-003)  
White Nylon

Door Lock Rod Clip  
Holds 4mm Rod  
Accord  
1998 - On

UNIT PACKAGE: 15

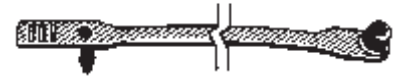

**14284**

(Honda: 90669-671-0000,  
90669-671-0030;  
Toyota: 90463-10337)  
Nylon

Cable Strap  
Length: 110mm (5-5/16")  
Max. Bundle Dia.: 23mm  
Fits Into 6mm Hole

UNIT PACKAGE: 15



**14279**

(Honda: 90672-692-0030;  
Toyota: 90463-10024)  
Nylon

Cable Strap  
Length: 170mm (6-11/16")  
Max Bundle Dia.: 40mm  
Fits Into 6mm Hole

UNIT PACKAGE: 25



Not Actual Size

**14298**

(Honda: 90672-SA0-0030;  
Mazda: 9928-91-053)  
Nylon

Releasable Cable Strap  
Overall Length: 148mm (5-3/4")  
Max. Bundle Dia: 30mm  
Fits Into 7mm Hole

UNIT PACKAGE: 25

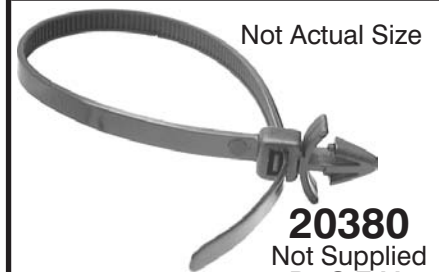

Not Actual Size

**20380**

Not Supplied  
By O.E.M.  
Black Nylon

Cable Strap  
Length: 200mm (8")  
Max. Bundle Dia: 44mm (1-3/4")  
Fits Into 6.3mm (1/4") Hole  
Import Cars

UNIT PACKAGE: 25



**17289**  
(60658-SB3-000)  
Nylon

Cowl Screen Screw Cover  
Head Dia: 17mm  
Fits Into 12mm Hole  
Civic 1984-On

UNIT PACKAGE: 25



**13225**  
Plated

"U" Type Nut  
4.2mm (#8) Screw Size  
11mm Wide  
16.5mm Long  
Panel Range: .5mm-2.5mm  
Center of Hole To Edge: 8mm

UNIT PACKAGE: 50



**20568**  
(87758-3D000)  
Yellow Nylon

Rocker Panel Clip  
With Sealer  
Top Head Size: 16mm x 20mm  
Bottom Head Size: 14mm x 18mm  
Stem Length: 10mm  
Elantra & Sonata  
2002 - On

UNIT PACKAGE: 15



**16470**  
(90212-SA5-003)  
Zinc

M10-1.25  
Hex Flange Nut  
With Serrations  
20mm Flange O.D.  
14mm Hex  
Class 10  
Used On Honda  
Exhaust Systems

UNIT PACKAGE: 25

**HYUNDAI**



**20566**  
(87756-3D000)  
White Nylon

Body Side Moulding Clip  
With Sealer  
Head Size: 14mm x 14mm  
Stem Length: 10mm  
M4.2 (#8) Screw Size  
Elantra & Sonata  
2002 - On

UNIT PACKAGE: 15



**20543**  
(81126-37010)  
Black Nylon

Hood Insulation Retainer  
Head Diameter: 26mm  
Stem Diameter: 12mm  
Stem Length: 14mm  
Hyundai Elantra & Sonata  
And Kia Optima  
1995 - On

UNIT PACKAGE: 15

**INFINITI**



**20570**  
(75307-SN7-000)  
Black Nylon

Nylon Moulding Nut  
With Brass Insert  
M4-0.7 Thread  
12mm Flange O.D.  
10mm Hex  
Height: 11mm  
1994 - On

UNIT PACKAGE: 15



**20567**  
(87756-38000)  
Black Nylon

Body Side Moulding Clip  
With Sealer  
Small Head Size: 8mm x 9mm  
Large Head Size: 14mm x 18mm  
Stem Length: 10mm  
Elantra & Sonata  
2002 - On

UNIT PACKAGE: 15



**20673**  
(80874-0P000)  
White Nylon

Cowl Vent Grommet  
With Sealer  
Head Size: 13mm x 13mm  
Stem Length: 13mm  
**Use With Auveco 17633**  
Nissan & Infiniti  
1997 - On

UNIT PACKAGE: 15

**INFINITI (Cont.)**



**20604**  
(01281-00711)  
Natural Nylon

Rocker Moulding  
Screw Grommet  
M4.2 (#8) Screw Size  
Head Diameter: 20mm  
Stem Length: 15mm  
Nissan & Infiniti  
1995 - On

UNIT PACKAGE: 10



**19468**  
(65846-40F00)  
Black Nylon

Hood Insulation Retainer  
Head Diameter: 28mm  
Stem Diameter: 6mm  
Stem Length: 10mm  
J30, M30 & Q45  
1989-On

UNIT PACKAGE: 15



**20668**  
(01553-09791)  
White Nylon

Trim Panel Retainer  
Top Head Diameter: 13mm  
Middle Head Diameter: 16mm  
Bottom Head Diameter: 18mm  
Stem Diameter: 9mm  
Stem Length: 14mm  
Nissan & Infiniti  
1999 - On

UNIT PACKAGE: 15

**INFINITI (Cont.)**



**20669**  
(01553-07111)  
Black Nylon

Trim Panel Retainer  
Top Head Diameter: 13mm  
Middle Head Diameter: 15mm  
Bottom Head Diameter: 18mm  
Stem Diameter: 9mm  
Stem Length: 15mm  
Nissan Altima and Infiniti G35 & Q45  
1997 - On

UNIT PACKAGE: 25

**ISUZU**



**17195**  
(Isuzu: 8942180270)  
Black Nylon

Grille Clip  
13mm Wide 22mm Long  
Ford Escort, Honda,  
Isuzu, Mitsubishi & Plymouth Laser

UNIT PACKAGE: 25



**17355**  
(GM: 94467458;  
Isuzu: 8944674584)  
Nylon

Windshield Reveal Moulding Clip  
Geo Storm  
1992-On

UNIT PACKAGE: 10

**ISUZU (Cont.)**



**14739**  
(Isuzu: 8941340270;  
Toyota:  
90189-05012)  
Natural Nylon

#6 Screw Size  
16mm Wide  
12mm Long

Snaps Into 6mm x 10mm Hole  
UNIT PACKAGE: 50



**14269**  
(Isuzu: 8942264920;  
Mazda: 9927-40-825;  
Toyota:  
67771-01010,  
67771-12010)  
White Nylon

Door Panel Retainer  
Top Head Diameter: 13mm  
Middle Head Diameter: 15.5mm  
Bottom Head Diameter: 18mm  
Stem Length: 14mm  
Overall Length: 20.5mm  
Stem Diameter: 9.5mm

UNIT PACKAGE: 25



**14696**  
(Isuzu: 8942981190;  
Honda: 90684-SA5-0030;  
Nissan: 10998-30880)  
Black Nylon

Push-Type Retainer  
Head Diameter: 15mm  
Stem Length: 11mm  
Fits Into 6mm Hole

UNIT PACKAGE: 25

Visit The  
Web Site At  
[www.auveco.com](http://www.auveco.com)

**ISUZU (Cont.)**

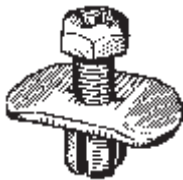

**14727**

(Isuzu: 8942211500;  
Nissan: 63844-00100)  
Black Nylon

Push-Type Retainer  
Head Size: 14mm x 22mm  
Stem Length: 9mm  
Fits Into 7mm Hole

UNIT PACKAGE: 25



**17076**

(GM: 94145515;  
Isuzu: 89414-55150)

Inner Fender Shield &  
Bumper Fascia Retainer  
Head Dia: 18mm  
Stem Length: 23mm  
Stem Dia: 7mm  
Geo Storm &  
Isuzu 1990-On

UNIT PACKAGE: 25



**20312**

(GM: 15021761;  
Chry: 5027550AB)  
Yellow Nylon

Hood Prop Rod Clip  
7mm Rod Diameter  
Snaps Into 10mm Hole  
GM Cars & Trucks  
Chrysler PT Cruiser  
Isuzu Hombre  
1990 - On

UNIT PACKAGE: 10

**KIA**



**20543**

(81126-37010)  
Black Nylon

Hood Insulation Retainer  
Head Diameter: 26mm  
Stem Diameter: 12mm  
Stem Length: 14mm  
Hyundai Elantra & Sonata  
And Kia Optima  
1995 - On

UNIT PACKAGE: 15

**LEXUS**



**19492**

(75039-33040)

Front Fender  
Moulding Clip  
ES300  
1991 - On

UNIT PACKAGE: 5

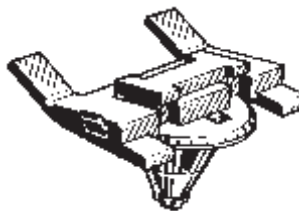

**17989**

(75049-33010)  
Black Nylon

Side Moulding Retainer  
Lexus 1990-On

UNIT PACKAGE: 5

# LEXUS CLIPS & FASTENERS

**Sec. 22**



**19899**  
(75397-48010)  
Red Nylon

Moulding Clip  
ES300 & RX300  
1999 - On

UNIT PACKAGE: 15



**19119**  
(75049-33020)  
Brown Nylon

Door Upper Moulding Clip  
ES300 1994-On

UNIT PACKAGE: 5



**19776**  
(75545-24030)  
White Nylon

Windshield Moulding Clip  
SC300 & SC400  
1992 - On

UNIT PACKAGE: 10



**20661**  
(75397-33010)  
White Nylon

Body Side Moulding Clip  
With Sealer  
Head Size: 16mm x 20mm  
Stem Length: 9mm  
Lexus ES300  
1997 - On

UNIT PACKAGE: 10



**19120**  
(75039-33060)  
Brown & White Nylon

Door Lower Moulding Clip  
ES300 1991-On

UNIT PACKAGE: 10



**19783**  
(Ford: N811169-S,  
W705550-S300;  
Toyota: 90075-10801,  
90189-06111)  
White Nylon

Head Diameter: 13mm  
Stem Length: 9mm  
Fits Into 11mm Hole  
Ford, Lexus & Toyota

UNIT PACKAGE: 50



**20605**  
(75397-48030)  
Orange Nylon

Moulding Clip  
With Sealer  
Head Size: 15mm x 20mm  
Stem Length: 15mm  
Lexus  
1999 - On

UNIT PACKAGE: 10



**19482**  
(75039-33010)  
Brown & White Nylon

Front Door  
Outside Moulding Clip  
ES300  
1991-On

UNIT PACKAGE: 5



**19742**  
(90189-06104)  
Natural Nylon

Fender Lining  
Screw Grommet  
#12 (M5.5) Screw Size  
Head Diameter: 18mm  
Stem Length: 15mm  
Fits Into A 9mm Square Hole  
Lexus IS300 And Toyota  
Avalon, Camry & Sienna  
1997 - On

UNIT PACKAGE: 15



**19900**  
(75395-33030)  
Pink Nylon

Moulding Clip  
ES300 & RX300  
1999 - On

UNIT PACKAGE: 15



**20662**  
(90467-12070)  
Black Nylon

Bumper Cover Clip  
Head Size: 13mm x 13mm  
Stem Length: 12mm  
Fits Into 9mm Square Hole  
Lexus GS300 & GS400  
1998 - On

UNIT PACKAGE: 10



**14273**  
(90189-06005)  
White Nylon

Screw Grommet  
#14 (1/4") or M6.3-1.81 Screw Size  
Head Diameter: 18mm  
Stem Length: 16mm  
Fits Into 8mm x 8mm Hole  
Lexus & Toyota

UNIT PACKAGE: 50

**Please Order  
In Unit Package  
Quantity Not Pieces**

**Sec. 22****LEXUS CLIPS & FASTENERS****14267**(90189-06013)  
Black NylonScrew Grommet  
#14 (1/4") or M6.3-1.81 Screw Size  
Head Diameter: 20mm  
Stem Length: 17mm  
Fits Into 8mm x 8mm Hole  
Lexus & Toyota

UNIT PACKAGE: 25

**18297**(Toyota: 90467-08004,  
90467-08011)  
(GM: 94842841, 94849113)  
Black NylonHood Seal Retaining Clip  
Head Diameter: 13mm  
Stem Length: 11mm  
Fits Into 5mm Hole  
Lexus, Toyota, Geo Prizm & Nova  
1985 - On

UNIT PACKAGE: 50

**17991**(90467-06092)  
White NylonRetaining Clip  
Head Size: 8mm x 17mm  
Stem Length: 14mm  
Fits Into 8mm Hole  
Lexus 1990-On

UNIT PACKAGE: 10

**20660**(90901-89004)  
Yellow NylonBumper Screw Grommet  
With Sealer  
M6.3 (#14) Screw Size  
Head Size: 16.5mm x 18mm  
Stem Length: 25mm  
Lexus GS300 & GS400  
1998 - On

UNIT PACKAGE: 10

**17990**(90467-09138)  
Black NylonRetaining Clip  
Head Size: 14mm x 15mm  
Stem Length: 19mm  
Fits Into 7mm Hole  
Lexus 1990-On

UNIT PACKAGE: 5

**20473**(67771-12070)  
White NylonDoor Panel &  
Rocker Moulding Retainer  
With Sealer  
Top Head Diameter: 13mm  
Bottom Head Diameter: 18mm  
Stem Diameter: 11mm  
Stem Length: 14mm  
Lexus SC300/400  
Toyota Avalon & Corolla  
1992 - On

UNIT PACKAGE: 15

**19534**(90467-10152)  
Natural NylonCowl Vent Grommet  
Flange Diameter: 18mm  
Stem Length: 16mm  
Fits Into 9mm Hole  
**Use With Auveco 19535**  
Lexus ES300, Toyota Camry  
& Tercel  
1995 - On

UNIT PACKAGE: 10

**19113**(90467-08124)  
Black NylonHood Insulation Retainer  
Head Diameter: 25mm  
Stem Diameter: 8mm  
Stem Length: 12mm  
Toyota Supra 1993-On  
Lexus 1994-89

UNIT PACKAGE: 15

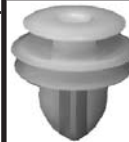
**20558**(62217-13010)  
White NylonGarnish Moulding Retainer  
Top Head Diameter: 13mm  
Middle Head Diameter: 16mm  
Bottom Head Diameter: 15mm  
Stem Diameter: 10mm  
Stem Length: 11mm  
Lexus and Toyota Corolla,  
Matrix & 4 Runner  
2003 - On

UNIT PACKAGE: 25

**19535**(90467-07126)  
Black NylonCowl Vent Pin Retainer  
Head Diameter: 16mm  
Stem Length: 17mm  
**Use With Auveco 19534**  
Lexus ES300, Toyota Camry  
& Tercel 1995 - On

UNIT PACKAGE: 10

**19729**(90467-09050)  
Black NylonHood Insulation Retainer  
Head Diameter: 25mm  
Stem Length: 10mm  
Fits Into 7mm Hole  
Lexus, Toyota Camry & Solara  
1998-On

UNIT PACKAGE: 15

**20575**

(67771-12080)

Yellow &amp; White Nylon

Door Panel & Rocker  
Moulding Retainer  
Top Head Diameter: 13mm  
Middle Head Diameter: 16mm  
Bottom Head Diameter: 18mm  
Stem Diameter: 10mm  
Stem Length: 13mm  
Overall Length: 20mm  
Toyota & Lexus  
1998 - On

UNIT PACKAGE: 15



# MAZDA CLIPS & FASTENERS

**Sec. 22**



**20559**

(GM: 88970345;  
Toyota: 90467-10167)  
Blue Nylon

Garnish Moulding Retainer  
Top Head Diameter: 13mm  
Middle Head Diameter: 16mm  
Bottom Head Diameter: 18mm  
Stem Diameter: 9mm x 9mm  
Stem Length: 11mm  
Pontiac Vibe, Lexus and Toyota  
2000 - On

UNIT PACKAGE: 25



**17988**

(90467-09143)  
Black Nylon

Push-Type Retainer  
Head Diameter: 19mm  
Stem Length: 26mm  
Fits Into 9mm Hole  
Lexus 1990-On

UNIT PACKAGE: 10



**18270**

(90467-07117)  
Black Nylon

Push-Type Retainer  
Head Dia: 17mm  
Stem Length: 9mm  
Fits Into 7mm Hole  
Lexus 1990-On

UNIT PACKAGE: 10



**19257**

(67771-12050)  
Maroon Nylon

Front & Rear Door  
Trim Board Retainer  
Small Head Diameter: 13mm  
Large Head Diameter: 18mm  
Stem Diameter: 9mm  
Stem Length: 14mm  
Lexus and Toyota Celica,  
Corolla & Previa 1990-On

UNIT PACKAGE: 15



**20577**

(GM: 88970494;  
Toyota: 90467-07168)  
Black Nylon

Rocker Panel & Garnish Moulding  
Push-Type Retainer  
Head Diameter: 20mm  
Stem Length: 8mm  
Fits Into 7mm Hole  
Pontiac Vibe 2004 - 2003  
Lexus & Toyota  
2000 - On

UNIT PACKAGE: 15



**20469**

(69293-12030)  
Natural Nylon

Door Lock Rod Clip  
Rod Size: 5mm  
Right (Passenger) Side  
Lexus ES 300 2001 - 97  
Toyota Camry, Celica, Corolla,  
Echo, Highlander, MR2, RAV4,  
Tundra and 4-Runner  
1994 - On

UNIT PACKAGE: 10



**17439**

(90467-09093)  
Black Nylon

Bumper Cover  
Push-Type Retainer  
Head Diameter: 15mm  
Stem Length: 27mm  
Fits Into 9mm Hole  
LS-400

UNIT PACKAGE: 10



**17992**

(90467-07138)  
Black Nylon

Push-Type Retainer  
Head Diameter: 20mm  
Stem Length: 12mm  
Fits Into 7mm Hole  
Lexus 1990-On

UNIT PACKAGE: 10



**20470**

(69293-12040)  
Yellow Nylon

Door Lock Rod Clip  
Rod Size: 5mm  
Left (Driver) Side  
Lexus ES 300 2001 - 97  
Toyota Camry, Celica, Corolla,  
Echo, Highlander, MR2, RAV4,  
Tundra and 4-Runner  
1994 - On

UNIT PACKAGE: 10



**18939**

(90467-09101)  
Black Nylon

Bumper Cover  
Push-Type Retainer  
Head Diameter: 18mm  
Stem Length: 23mm  
Fits Into 9mm Hole  
ES300  
1993-On

UNIT PACKAGE: 25



**19219**

(90467-09096)  
Black Nylon

Front Bumper  
Push-Type Retainer  
Head Diameter: 15mm  
Stem Length: 27mm  
Fits Into 9mm Hole  
LS400 1993-On  
Toyota Celica & Supra  
1989-On

UNIT PACKAGE: 10



**20534**

(69293-12050)  
Natural Nylon

Door Lock Rod Clip  
Rod Size: 5mm  
Fits Into 8.5mm Hole  
Right (Passenger) Side  
Lexus ES250, 300 & RX300  
And Toyota Tacoma  
1990 - On

UNIT PACKAGE: 10



**20535**

(69293-12060)  
Yellow Nylon

Door Lock Rod Clip  
Rod Size: 5mm  
Fits Into 8.5mm Hole  
Left (Driver) Side  
Lexus ES250, 300 & RX300  
And Toyota Tacoma  
1990 - On

UNIT PACKAGE: 10

Not Actual Size



**20380**

Not Supplied By O.E.M.  
Black Nylon

Cable Strap  
Length: 200mm (8")  
Max. Bundle Dia: 44mm (1-3/4")  
Fits Into 6.3mm (1/4") Hole  
Import Cars

UNIT PACKAGE: 25



**17993**

(90179-05060)  
Black Nylon

Nylon "U" Nut  
#10 Screw Size  
18mm Wide, 27mm Long  
Panel Range: Up To 3mm  
Center Of Hole To Edge: 14mm  
Lexus 1990-On

UNIT PACKAGE: 10

**MAZDA**

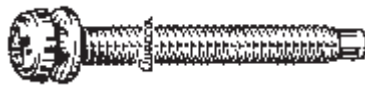

**16550**

(GJ21-51-047A)

M5-.8 x 42mm  
Headlight Adjusting Screw

UNIT PACKAGE: 25



**16555**

(GJ21-51-036)

Headlight Adjusting Spring

UNIT PACKAGE: 10



**19469**

(G219-51-081)  
White Nylon

Front Combination  
Headlight  
Pivot Holder  
MX-6, MPV &  
Protege  
1995-On

UNIT PACKAGE: 10



**19228**

(NA01-50-101A)  
Nylon

Bumper Clip  
Miata  
1992-On

UNIT PACKAGE: 10



**18822**

(KA80-51-RF5A)  
Nylon

Body Side Garnish Moulding Clip  
Mazda Millenia & Ford Probe  
1995-On

UNIT PACKAGE: 15



**18882**

(Ford: KA80-51-PR6;  
Mazda: EA01-50-048)  
Black Nylon

Body Side Lower  
Wide Moulding Grommet  
Ford Probe & Mazda MX6  
1993-On

UNIT PACKAGE: 10



**19450**

(T001-50-M48B)  
Natural Nylon

Rear Door Garnish Clip  
Millenia  
1995 - On

UNIT PACKAGE: 25



**19451**

(B173-50-852A)  
Black Nylon

Cowl Panel Clip  
Millenia  
1995 - On

UNIT PACKAGE: 15

# MAZDA CLIPS & FASTENERS

## Sec. 22



**19755**  
(LB82-50-669A)  
White Nylon

Door Belt  
Moulding Clip  
Width: 25mm  
Length: 32mm  
MPV  
1998 - On

UNIT PACKAGE: 10



**12589**  
(8173-50-931)  
Nylon

Windshield Moulding Clip  
28mm Wide; 26mm Long

UNIT PACKAGE: 15



**15469**  
Nylon

Windshield Reveal Moulding Clip  
15mm Wide, 25.5mm Long  
Nissan & Mazda

UNIT PACKAGE: 25



**14719**  
(H001-50-609)  
Nylon

Windshield Moulding Clip  
25mm Wide  
10mm Long

UNIT PACKAGE: 25



**17290**  
(B092-50-609)  
Nylon

Rear Window Moulding Clip  
MX6 1988-On  
Ford Probe 1988-On  
Mercury Tracer 1987-On

UNIT PACKAGE: 15

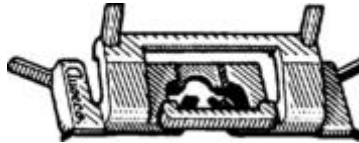

**14717**  
(HA01-50-609)  
Nylon

Windshield Moulding Clip  
45mm Wide  
13mm Long

UNIT PACKAGE: 25



**12591**  
(1243-50-609)  
Nylon

Windshield Moulding Clip  
28.5mm Wide  
Clip Length: 14.5mm  
Arm Length: 22.5mm

UNIT PACKAGE: 25



**19648**  
(HG30-50-6B9A)  
Brown Nylon

Windshield Clip  
Width: 13mm  
Length: 49mm  
Height: 11mm  
929 & Millenia  
1992 - On

UNIT PACKAGE: 10



**19452**  
(J0Y1-50-619C)  
White Nylon

Rear Window  
Moulding Clip  
With Adhesive Backing  
Millenia  
1995 - On

UNIT PACKAGE: 10



**19831**  
(LA01-50-6A8A)  
White Nylon

Window Screw Grommet  
With Sealer Gasket  
#6 Screw Size  
MPV  
1998 - On

UNIT PACKAGE: 10



**13930**  
(Nissan: 96706-B0700;  
Mazda: 9991-00-412)  
Natural Nylon

#8 Screw Size  
9.5mm Wide  
9.5mm Long  
Snaps Into 7mm x 7mm Hole

UNIT PACKAGE: 50



**14255**

(Mitsubishi: MS-480001;  
Honda: 75522-611-0000;  
Mazda: 9991-00-412)  
Black Nylon

#8 Screw Size  
9.5mm Wide  
9.5mm Long  
Snaps Into 7mm x 7mm Hole

UNIT PACKAGE: 50



**14274**

(Mazda: 9991-00-601;  
Honda: 75521-611-0000;  
Nissan: 96706-P0105;  
Toyota: 90189-06010)  
Natural Nylon

#10 Screw Size  
13mm Wide; 13mm Long  
Snaps Into 8.5mm x 8.5mm Hole

UNIT PACKAGE: 25



**14358**

(Mazda: 0483-66-061-A;  
Ford: E92Z-13A147A)  
White Nylon

#10 Screw Size  
13mm Wide 13mm Long  
Snaps Into 8mm x 8mm Hole  
Ford Probe & Mazda

UNIT PACKAGE: 25



**19832**

(LB84-68-AD5)  
White Nylon

Door Trim  
Screw Grommet  
With Sealer Gasket  
#6 Screw Size  
Head Size: 10mm x 10mm  
Stem Length: 15mm  
MPV

1998 - On

UNIT PACKAGE: 10



**14357**

(9991-00-501)  
Natural Nylon

#10 Screw Size  
12mm Wide  
12mm Long  
Snaps Into 8mm x 8mm Hole

UNIT PACKAGE: 25



**14362**

(8545-50-786)  
Black Nylon

#10 Screw Size  
Head Diameter: 13mm  
Fits Into 7mm Hole

UNIT PACKAGE: 25



**19748**

(KA78-50-AF4)  
Black Nylon

Splash Shield  
Screw Grommet  
#12 (M5.5) Screw Size  
Head Diameter: 18mm x 20mm  
Stem Length: 15mm  
626

1998 - On

UNIT PACKAGE: 10



**14313**

(Mazda: 9991-00-503)  
Honda: 90662-671-0030;  
Nissan: 68425-H5000)  
Natural Nylon

#10 Screw Size  
17mm Wide  
17mm Long  
Snaps Into 8mm x 8.5mm Hole

UNIT PACKAGE: 25



**14366**

(9991-00-402)  
Natural Nylon

Screw Grommet  
#6 Screw Size  
9.5mm Wide, 9.5mm Long  
Stem Length: 16mm  
Fits Into 7mm x 7mm Hole  
Also for Nissan/Datsun

UNIT PACKAGE: 50



**20579**

(FD02-50-798)  
Black Nylon

Cowl Vent Grommet  
With Sealer  
M4.2 (#8) Screw Size  
Head Size: 12mm x 22mm  
Stem Length: 13mm  
323, 626, Millenia & MX6  
1995 - On

UNIT PACKAGE: 10



**14364**

(9991-00-403)  
Natural Nylon

#8 Screw Size  
Head Diameter: 13mm  
Fits Into 7mm x 7mm Hole

UNIT PACKAGE: 25



**14695**

(Mazda: H001-50-841;  
Honda: 90661-SC7-0030;  
Mitsubishi: MS-480012;  
Nissan: 01651-00481,  
74798-S9000;  
Toyota: 90189-06042)  
White Nylon

Screw Grommet  
#8 Screw Size  
Head Diameter: 16mm  
Stem Length: 17mm  
Fits Into 8mm x 8mm Hole

UNIT PACKAGE: 25



**19833**

(H260-50-6K8)  
White Nylon

Cowl Screw Grommet  
With Sealer Gasket  
#8 (M4.2 - 1.41) Screw Size  
Head Size: 16mm x 22mm  
Stem Length: 20mm  
MPV  
1998 - On

UNIT PACKAGE: 10

# MAZDA CLIPS & FASTENERS

**Sec. 22**



**19743**

(GJ21-58-502A)  
Natural Nylon

Window Moulding  
Screw grommet  
#12 (M5.5) Screw Size  
18mm Wide, 22mm Long  
Snaps Into 11mm Hole

626

1998-On

UNIT PACKAGE: 15



**20463**

(S084-58-502)  
Natural Nylon

Door Glass  
Screw Grommet  
#12 Screw Size  
18mm Wide, 32mm Long  
Stem Length: 10mm

626

2000 - ON

UNIT PACKAGE: 10



**19753**

(GA2A-56-399A)  
Black Nylon

Front Fender  
Plate Seal Clip  
Head Diameter: 18mm  
Stem Length: 26mm

626

1998 - On

UNIT PACKAGE: 10



**17451**

(H001-68-719B)  
Natural Nylon

Rocker Scuff Plate Retainer  
Ford Probe 1988-On  
Mazda MX6 1988-On

UNIT PACKAGE: 25



**19138**

(Ford: F1CZ-5802316A;  
Mazda: BW0A-50-792)  
Gray Nylon

Cowl Top Vent Grille Retainer  
Ford Escort & Tracer  
Mazda 1991 - On

UNIT PACKAGE: 15



**17551**

(GJ21-50-H81)  
Natural Nylon

Cowl Screen Grommet  
Ford Probe 1988-On  
Mazda 626 & MX6 1988-On

UNIT PACKAGE: 25



**17552**

(GJ21-50-H82)  
Natural Nylon

Cowl Screen Grommet  
Ford Probe 1988-On  
Mazda 626 & MX6 1988-On

UNIT PACKAGE: 25



**17553**

(KA01-50-H16)  
Green Nylon

Rear Hatch Grommet  
Ford Probe 1988-On  
Mazda MX 6 1988-On

**Use With 17554**

UNIT PACKAGE: 25



**17554**

(KA01-50-H15A)  
Black Nylon

Rear Hatch Retainer  
Ford Probe 1988-On  
Mazda MX6 1988-On

**Use With 17553**

UNIT PACKAGE: 25



**14367**

(9924-90-512B)  
Black Nylon

Retainer

Head Diameter: 12mm  
Stem Length: 12mm  
Snaps Into 4mm Hole  
Panel Thickness: 2mm

UNIT PACKAGE: 50



**18458**

(Ford: F1CZ-16774-A;  
Mazda: B455-56-741)  
Black Nylon

Hood Insulation Retaining Clip  
Head Diameter: 14mm  
Stem Length: 10mm  
Fits Into 6mm Hole  
Ford Probe & MX6 1992-88

UNIT PACKAGE: 25



**14349**

(Mazda: 9926-40-543A;  
Nissan: 01553-00291)  
Black Nylon

Retaining Clip  
Head Dia: 11mm  
Stem Length: 15mm  
Fits Into 5.5mm Hole  
Panel Thickness: 5mm

UNIT PACKAGE: 50

**Sec. 22****MAZDA CLIPS & FASTENERS**

**18271**  
(9926-40-531B)  
Black Nylon

Hood Insulation Retainer  
Head Diameter: 14mm  
Stem Diameter: 6mm  
Stem Length: 15mm

UNIT PACKAGE: 25



**16777**  
(Mazda: B001-68-302-00;  
Toyota: 90950-01248)  
Black Nylon

Retaining Clip  
Head Dia: 15mm  
Stem Length: 15mm  
Panel Thickness: 2mm  
Fits Into 8mm Hole

UNIT PACKAGE: 25



**14380**  
(8133-50-022)  
Black Nylon

Retaining Clip  
Head Diameter: 18mm  
Stem Length: 18mm  
Snaps Into 8mm Hole  
Panel Thickness: 7mm

UNIT PACKAGE: 25



**19906**  
(B252-51-PJ5A)  
Black Nylon

Cowl Panel Retaining Clip  
Top Head Diameter: 12mm  
Bottom Head Diameter: 18mm  
Stem Length: 11mm  
Fits Into 9mm Hole  
Millenia  
1999 - On

UNIT PACKAGE: 10



**14709**  
(Mazda:  
G030-68-885-B-38;  
Ford: F22Z-16774-A,  
GA2A-56694)  
Black Nylon

Hood Insulation Retainer  
Head Diameter: 20mm  
Stem Length: 9mm  
Fits Into 6mm Hole

UNIT PACKAGE: 25



**17453**  
(B003-68-865-96)  
Gray Nylon

Rear Compartment  
Interior Trim Retainer  
Head Diameter: 15mm  
Stem Length: 14mm  
Stem Diameter: 6.5mm  
Ford Probe 1988-On  
Mazda MX6 1988-On

UNIT PACKAGE: 50

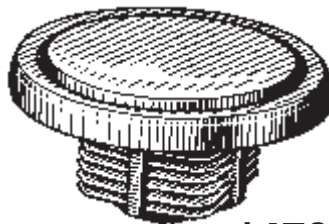

**14708**  
(B100-68-695)  
Gray Nylon

Panel Fastener  
Head Diameter: 40mm  
Stem Length: 17mm  
Fits Into 20mm x 20mm Hole

UNIT PACKAGE: 15



**18692**  
(Mazda: G031-58-762;  
Toyota: 67867-89103,  
97868-89101)  
Natural Nylon

Weatherstrip Retainer  
Head Size: 5mm x 15mm  
Stem Length: 10mm  
Fits Into 5mm Hole  
4-Runner 1989-83  
Mazda 1996-On

UNIT PACKAGE: 50



**20460**  
(G043-50-742)  
Black Nylon

Cowl Panel Retainer  
With Sealer  
Top Head Dia.: 14mm  
Bottom Head Dia.: 18mm  
Stem Dia.: 9mm  
Stem Length: 13mm  
626

2000 - On

UNIT PACKAGE: 10



**14269**  
(Mazda: 9927-40-825;  
Isuzu: 8942264920;  
Toyota: 67771-01010,  
67771-12010)  
White Nylon

Door Panel Retainer  
Top Head Diameter: 13mm  
Middle Head Dia.: 15.5mm  
Bottom Head Diameter: 18mm  
Stem Diameter: 9.5mm  
Stem Length: 14mm  
Overall Length: 20.5mm

UNIT PACKAGE: 25



**18824**  
(G350-68-AB1)  
White Nylon

Trim Panel Retainer  
Top Head Diameter: 13mm  
Bottom Head Diameter: 15mm  
Stem Length: 9.5mm  
Fits Into 9mm Hole  
Mazda 626, MX6, Millenia, MX3,  
929, Protege & MPV  
Ford Probe  
1992-On

UNIT PACKAGE: 50

# MAZDA CLIPS & FASTENERS

**Sec. 22**



## 20459

(GA2A-68-AB1A)  
Black Nylon

Trim Panel Retainer  
Top Head Dia.: 15mm  
Bottom Head Dia.: 16mm  
Stem Dia.: 9mm  
Stem Length: 10mm  
626  
2000 - On

UNIT PACKAGE: 10



## 14697

(Mazda: N304-13-356-A;  
GM: 94198687;  
Honda: 90657-SA6-0030)  
Black Nylon

Push-Type Retainer  
Head Diameter: 14mm  
Stem Length: 11mm  
Fits Into 7mm Hole

UNIT PACKAGE: 25



## 20465

(UB39-45-919)  
Black Nylon

Front & Rear Fender  
Push-Type Retainer  
Head Diameter: 18mm  
Stem Length: 9mm  
Fits Into 8mm Hole  
626

2000 - On

UNIT PACKAGE: 10



## 14363

(9927-40-821)  
Nylon

Door Panel  
Retainer  
Bottom Head Diameter: 17mm  
Stem Length: 14mm  
Overall Length: 20mm  
Fits Into 8mm Hole

UNIT PACKAGE: 25



## 17478

(B101-68-252-00)  
Black Nylon

Interior Trim  
Push-Type Retainer  
Head Diameter: 14mm  
Stem Length: 16mm  
Fits Into 6mm Hole  
Ford Probe 1988-On  
Mazda MX6 1988-On

UNIT PACKAGE: 25



## 19747

(UB39-50-795)  
Black Nylon

Stone Guard  
Push-Type Retainer  
Head Diameter: 18mm  
Stem Length: 10mm  
Fits Into 8mm Hole  
MPV  
1998-On

UNIT PACKAGE: 10



## 16778

(Mazda: 9927-40-822;  
Toyota: 62581-14020)  
Natural Nylon

Trim Panel Retainer  
Small Head Dia: 14mm  
Large Head Dia: 18mm  
Stem Length: 14mm  
Fits Into 8mm Hole

UNIT PACKAGE: 25



## 14260

(Mazda: 9926-50-625;  
Toyota: 90467-06017)  
Black Nylon

Push-Type  
Retainer  
Head Diameter: 15mm  
Stem Length: 12mm  
Fits Into 7mm Hole

UNIT PACKAGE: 15



## 17632

(Mazda: B092-51-833;  
Ford: MB-455-56143)  
Black Nylon

Push-Type Retainer  
Head Diameter: 18mm  
Stem Length: 12mm  
Fits Into 8mm Hole  
Mazda & Ford Aspire

UNIT PACKAGE: 10



## 19481

(GA2A-58-762)  
Blue Nylon

Weatherstrip Retainer  
Head Size: 5mm x 15mm  
Stem Length: 8mm  
Fits Into 6mm Hole  
Front & Rear Door  
and Hood Weatherstrip  
626 & Millenia  
1995 - On

UNIT PACKAGE: 50



## 19306

(GA5R-56-392)  
Black Nylon

Shroud Seal Board  
Push-Type Retainer  
Head Diameter: 16mm  
Stem Length: 12mm  
Fits Into 6mm Hole  
626

1994-On

UNIT PACKAGE: 10



## 18206

(GJ21-68885-B69)  
Gray Nylon

Push-Type Retainer  
Head Diameter: 18mm  
Stem Length: 12mm  
Fits Into 6mm Hole  
Ford Probe &  
MX6 1989-On

UNIT PACKAGE: 25



**19416**  
(Toyota: 90467-09139)  
Black Nylon

Bumper Cover &  
Wheel Housing  
Push-Type Retainer  
Head Diameter: 18mm  
Stem Length: 15mm  
Fits Into 9mm Hole  
Honda, Mazda 626 &  
Toyota Corolla  
1992-On

UNIT PACKAGE: 15



**14369**  
(1395-68-676,  
9926-50-635)  
Black Nylon

Push-Type Retainer  
Head Diameter: 20mm  
Stem Length: 9mm  
Fits Into 6mm Hole

UNIT PACKAGE: 15



**16000**  
(Honda:  
90675-SB3-003;  
Mazda: FB01-56-964;  
Nissan:  
63876-95596)  
Black Nylon

Push-Type Retainer  
Head Dia: 20mm  
Stem Length: 9mm  
Fits Into 8mm Hole

UNIT PACKAGE: 25



**19315**  
(BC1D-56-145)  
Black Nylon

Mud Guard Push-Type Retainer  
Head Diameter: 20mm  
Stem Length: (Exc. Pin): 9mm  
Fits Into 8mm Hole  
Protege  
1996-On

UNIT PACKAGE: 15



**17450**  
(Ford: E8B2-17C756C;  
Mazda: BF67-50-235)  
Black Nylon

Bumper Cover Retainer  
Head Size: 20mm x 30mm  
Stem Length: 11mm  
Fits Into 10mm Hole  
Ford Festiva 1988-On  
Mazda 323 1986-On

UNIT PACKAGE: 10



**15366**  
(Ford: E7GZ-17A904-B;  
Mazda: BF67-50-033)  
Gray Nylon

Bumper Retainer  
Head Size: 20mm x 30mm  
Stem Length: 11mm  
Fits Into 10mm Hole  
Mazda  
Mercury Tracer 1987-On

UNIT PACKAGE: 10



**16843**  
(Mazda:  
BF82-50-233;  
Nissan:  
01553-01393)  
Black Nylon

Bumper Cover Retainer  
Head Size: 20mm x 30mm  
Stem Length: 18mm  
Fits Into 10mm Hole

UNIT PACKAGE: 10



**17060**  
(Ford: E92Z-17C756C;  
Mazda: GJ21-50-034)  
Black Nylon

Bumper Cover Retainer  
Head Size: 20mm x 30mm  
Stem Length: 20mm  
Fits Into 10mm Hole  
Ford Probe & Mazda MX6 1989-On

UNIT PACKAGE: 10



**14378**  
(9927-70-901)  
Nylon

Tube/Cable  
Routing Clip  
For Holding Multiple  
Cables or Tubes  
Diameter: 8mm  
Fits Into 6mm Hole

UNIT PACKAGE: 25



**14714**  
(GA976-1391)  
Nylon

Tube Clip  
For 12mm Tubes  
41mm Long

UNIT PACKAGE: 20

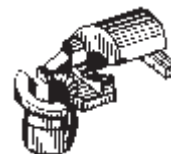

**14359**  
(9927-80-405)  
Nylon

Rod End Clip  
Holds 4mm Rods  
Snaps Into 6mm Hole

UNIT PACKAGE: 25





**14365**  
(9927-80-404)  
Nylon

Rod End Clip  
Holds 4mm Rods  
Snaps Into 6mm  
Hole

UNIT PACKAGE: 25



**20153**

White Door Lock Pawl  
Right-Hand Side  
Mazda Truck, Ford  
Continental, Contour,  
Explorer, Mountaineer, Mystique,  
Ranger, Sable & Taurus  
1996 - On

UNIT PACKAGE: 1



**20195**

Pink Door Lock Pawl  
Left-Hand Side  
Ford Continental, Contour,  
Explorer, Mountaineer, Mystique,  
Ranger, Sable  
& Taurus And Mazda Truck  
1996 - On

UNIT PACKAGE: 1

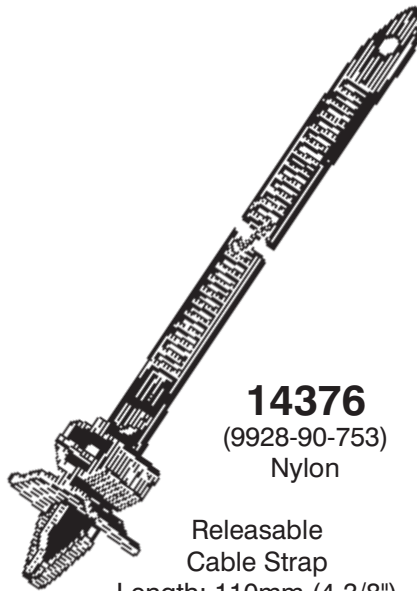

**14376**  
(9928-90-753)  
Nylon

Releasable  
Cable Strap  
Length: 110mm (4-3/8")  
Max. Bundle  
Diameter: 25mm  
Fits Into 7mm Hole

UNIT PACKAGE: 15



**19754**  
(UB42-67-013)  
Black Nylon

Wiring Harness  
Routing Clip  
MPV  
1998 - On

UNIT PACKAGE: 15



Not Actual Size

**14298**

(Mazda: 9928-91-053;  
Honda: 90672-SA0-0030)  
Nylon

Releasable Cable Strap  
Overall Length: 148mm (5-3/4")  
Max. Bundle  
Diameter: 30mm  
Fits Into 7mm Hole

UNIT PACKAGE: 25



**14750**

(Toyota: 53879-14010-A,  
53879-14020,  
53879-22030; GM: 94841226;  
Mazda: LA01-56-135)  
Black Nylon

Nylon "U" Nut  
Fender/Wheel  
Housing Applications  
#10 Screw Size  
20mm Wide  
31mm Long

Panel Range: Up to 1mm  
Center of Hole To Edge: 11mm  
Toyota, Geo Prizm & Nova and  
Mazda

UNIT PACKAGE: 15

Not Actual Size



**20380**

Not Supplied By O.E.M.  
Black Nylon

Cable Strap  
Length: 200mm (8")  
Max. Bundle Dia: 44mm (1-3/4")  
Fits Into 6.3mm (1/4") Hole  
Import Cars

UNIT PACKAGE: 25

**19669**  
Same As 14750 Except For Packing

UNIT PACKAGE: 25

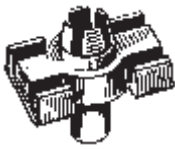
**Sec. 22****MERCEDES-BENZ CLIPS & FASTENERS****13142**(000-990-21-92)  
Nylon

Moulding Clip

UNIT PACKAGE: 25

**20201**(006-988-30-78)  
Natural NylonBody Side  
Moulding Clip  
Body Style 124  
1995 - 86

UNIT PACKAGE: 10

**20235**(002-994-65-45)  
White NylonBody Side Moulding Clip  
Body Styles  
124 & 201  
1995 - 84

UNIT PACKAGE: 10

**20238**(001-988-49-81)  
White NylonBody Side  
Moulding Clip  
Body Styles  
124 & 201  
1995 - 84

UNIT PACKAGE: 15

**20657**(004-988-76-78,  
004-988-77-78)  
Black NylonMoulding Clip  
11mm Wide  
20mm Long

UNIT PACKAGE: 15

**20202**(201-988-04-78)  
Natural NylonBody Side Quarter Panel  
Moulding Clip  
Body Style 201  
1995 - 84

UNIT PACKAGE: 10

**20239**(001-988-31-81)  
White NylonBody Side  
Moulding Clip  
Body Style 124  
1995 - 86

UNIT PACKAGE: 15

**20658**(201-988-06-78)  
Black NylonMoulding Clip  
16mm Wide  
22mm Long  
Fits Into 6mm Hole

UNIT PACKAGE: 10

**20198**(001-988-51-81)  
White NylonBody Side Moulding Clip  
Body Styles  
124 & 201  
1995 - 86

UNIT PACKAGE: 15

**20197**(201-988-07-78)  
Black NylonBody Side  
Moulding Clip  
Body Style 201  
1993 - 84

UNIT PACKAGE: 10

**20199**(006-988-35-78)  
White NylonBody Side Moulding Clip  
Body Style 201  
1993 - 87

UNIT PACKAGE: 10

**13153**(000-988-56-71)  
Nylon

Moulding Clip

UNIT PACKAGE: 25

**17668**(123-990-01-92)  
NylonMoulding Clip  
Head Dia: 9mm x 11mm  
Stem Length: 10mm  
Fits Into 6mm x 6mm hole  
Mercedes-Benz  
1977-On

UNIT PACKAGE: 10

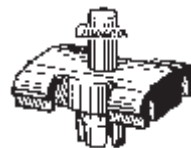
**16123**(201-988-03-78)  
NylonMoulding Clip  
16.5mm Wide, 18mm Long  
Fits Into 6mm Hole

UNIT PACKAGE: 25

**20236**(006-988-72-78)  
White NylonBody Side Moulding Clip  
Body Styles  
124 & 129  
1995 - 90

UNIT PACKAGE: 10

# MERCEDES-BENZ CLIPS & FASTENERS **Sec. 22**



**20656**  
(140-698-00-82)  
White Nylon

Rocker Moulding Clip  
Head Diameter: 12mm x 16mm  
Stem Length: 28mm  
Overall Length: 36mm

UNIT PACKAGE: 10



**20204**  
(001-988-29-81)  
Natural Nylon

Moulding Insert  
Head Diameter: 18mm  
Stem length: 13mm  
Fits Into 9mm Hole  
Body Styles  
124, 129 & 140  
1986 - On

UNIT PACKAGE: 15



**20205**  
(001-988-76-81)  
White Nylon

Moulding Insert  
Head Dia: 11.5mm  
Stem Length: 12mm  
Fits Into 9mm Hole  
Body Styles  
170, 202, 203, 208, 210 & 220  
1994 - On

UNIT PACKAGE: 25



**20659**  
(201-997-22-81)  
White Nylon

Hood & Trunk  
Moulding Insert  
Head Diameter: 7mm  
Stem Length: 6mm  
Fits Into 5.5mm Hole  
C, CL, CLK, E, SLK & S Class  
1996 - On

UNIT PACKAGE: 15



**20200**  
(001-988-77-81)  
Natural Nylon

Moulding Insert  
Head Dia: 8mm  
Stem Length: 5mm  
Fits Into 7mm Hole  
Body Styles  
202 & 210  
1994 - On

UNIT PACKAGE: 25



**13141**  
(000-988-15-81)  
Red Nylon

Moulding Insert  
UNIT PACKAGE: 50



**13144**  
(000-988-55-81)  
Blue Nylon

Moulding Insert  
UNIT PACKAGE: 50



**13157**  
(000-987-10-81)  
White Nylon

Moulding Insert  
UNIT PACKAGE: 50



**16124**  
(001-988-20-81)  
Red Nylon

Tubular Nut  
I.D.: 4.5mm, Length: 14mm  
Fits Into 9mm Hole

UNIT PACKAGE: 50



**13150**  
(123-997-03-81)  
Nylon

Barrel Nut  
For 2mm Stud  
Fits Into 4mm Hole

UNIT PACKAGE: 50



**20647**  
(000-988-16-25)  
White Nylon

Cowl Vent Nylon Nut  
M3.5 (#6) Screw Size  
Head Size: 9.5mm x 9.5mm  
Stem Length: 14mm  
Fits Into 6.5mm x 7mm Hole

UNIT PACKAGE: 25



**20646**  
(001-988-12-25)  
Natural Nylon

M3.5 (#6) Screw Size  
Head Diameter: 12mm  
Stem Length: 20mm  
Fits Into 5.5mm Hole

UNIT PACKAGE: 10



**20404**  
(000-988-86-25)  
Natural Nylon

Rocker Panel Moulding  
Screw Grommet  
Use With M4.2 (#8) Screw  
Class CL, E & S  
1996 - On

UNIT PACKAGE: 25



**20315**  
(673-988-00-25)  
Black Nylon

Screw Grommet  
#8 (M4.2) Screw Size  
Head Diameter: 25mm  
Stem Length: 17mm  
Body Styles  
124, 126, 170, 201,  
202, 208 & 210  
1991 - On

UNIT PACKAGE: 15

**Sec. 22****MERCEDES-BENZ CLIPS & FASTENERS****13145**(000-988-23-78)  
Black Metal

Panel Fastener

UNIT PACKAGE: 25

**20644**(003-988-19-78,  
201-988-25-78)

Natural Nylon

Grille Retainer

Head Size: 4mm x 6.5mm

Stem Diameter: 4mm

Stem Length: 8mm

UNIT PACKAGE: 25

**13148**(000-987-10-15)  
White Nylon

Retaining Clip

UNIT PACKAGE: 25

**20643**(000-997-91-86)  
Black Nylon

Retainer

Head Diameter: 13mm

Stem Diameter: 6.5mm

Stem Length: 11mm

UNIT PACKAGE: 10

**20188**(003-988-41-78)  
White Nylon

Trim Panel Retainer

Small Head Dia: 13mm

Large Head Dia: 18mm

Stem Diameter: 8.5mm

Stem Length: 11mm

Body Styles 107, 108,

109, 114, 115, 123 &amp; 124

1995 - 68

UNIT PACKAGE: 10

**20642**(000-990-57-92)  
Gray NylonDoor Panel  
Retaining Clip

Top Head Diameter: 13mm

Bottom Head Diameter: 16mm

Stem Diameter: 9mm

Stem Length: 13mm

UNIT PACKAGE:

**13230**(Mercedes  
000-990-03-92;  
Volvo: 947-098)  
Black Nylon

Push-Type Retainer

Head Dia. 10mm

Stem Length: 7mm

Fits Into 5mm Hole

UNIT PACKAGE: 50

**20187**(000-990-34-92)  
Black Nylon

Radiator Housing

Push-Type Retainer

Head Diameter: 10mm

Stem Length: 10mm

Fits Into 6mm Hole

Body Styles 116, 123, 124, 126,  
129, 140, 170, 201, 208 & 210

1974 - On

UNIT PACKAGE: 15

**19434**(GM: 90319187;  
Mercedes: 000-990-25-92)  
White Nylon

Cowl Side Lower Moulding

Bumper Fascia

Push-Type Retainer

Head Diameter: 10mm

Stem Length: 12mm

Fits Into 6mm Hole

1997 - On

UNIT PACKAGE: 25

**20314**(000-990-37-92)  
Black NylonTrunk Trim &  
General Purpose

Push-Type Retainer

Head Diameter: 13mm

Stem Length: 14mm

Fits Into 8mm Hole

SL500 &amp; SL600 Convertible

1999 - On

UNIT PACKAGE: 15

**20640**(000-990-40-92,  
124-990-05-92-9051)  
Black Nylon

Push-Type Retainer

Head Diameter: 12mm

Stem Length: 11mm

Fits Into 5mm Hole

UNIT PACKAGE: 25

**20639**(000-990-44-92)  
Black Nylon

Push-Type Retainer

Head Diameter: 12mm

Stem Length: 11mm

Fits Into 5mm x 5mm Hole

UNIT PACKAGE: 25

**20641**(000-990-46-92)  
Black Nylon

Push-Type Retainer

Head Diameter: 17mm

Stem Length: 15mm

Fits Into 6mm Hole

UNIT PACKAGE: 10

# MERCEDES-BENZ CLIPS & FASTENERS **Sec. 22**



**20636**  
(123-990-00-92)  
Dark Gray Nylon

Push-Type Retainer  
Head Diameter: 12mm  
Stem Length: 10mm  
Fits Into 8.5mm Hole  
UNIT PACKAGE: 15



**20637**  
(123-990-02-92)  
Black Nylon

Push-Type Retainer  
Head Diameter: 20mm  
Stem Length: 9mm  
Fits Into 8mm Hole  
UNIT PACKAGE: 10



**20638**  
(201-990-02-92)  
Black Nylon

Push-Type Retainer  
Head Diameter: 20mm  
Stem Length: 14mm  
Fits Into 8.5mm Hole  
UNIT PACKAGE: 25



**20203**  
(124-990-07-92)  
Black Nylon

Push-Type Retainer  
Head Size: 11mm x 14mm  
Stem Length: 8mm  
Fits Into 7mm x 8mm Hole  
Body Styles  
124, 129, 140, 170, 202,  
203, 208, 210, 215, & 220  
1986 - On  
UNIT PACKAGE: 25



**20645**  
(201-990-00-50)  
Black Nylon

Rear Compartment Carpet Retainer  
Fits Onto 5mm Stud  
Head Diameter: 24mm  
10mm Hex  
UNIT PACKAGE: 25



**20653**  
Gray Nylon

Wire Routing Clip  
Inside Diameter: 7mm x 10mm  
Fits Into 6mm Hole  
BMW & Mercedes  
UNIT PACKAGE: 50

Not Actual Size



**20654**  
(001-997-42-90)  
Black Nylon

Cable Strap  
Overall Length: 120mm (4-3/4")  
Fits Into 8mm Hole  
UNIT PACKAGE: 10

Not Actual Size



**20655**  
(114-997-02-90)  
Black Nylon

Cable Strap  
Overall Length: 160mm (6-1/2")  
Fits Into 8mm Hole  
UNIT PACKAGE: 10



**13152**  
(000-994-13-45)  
Metal

Snap-In Nut  
M4.2 (#8) Screw Size  
UNIT PACKAGE: 50

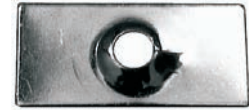

**20652**  
(123-994-03-45)  
Zinc & Yellow

M6.5 Tapping Screw Size  
15mm x 30mm  
UNIT PACKAGE: 25



**20648**  
(123-994-01-45)  
Zinc & Yellow

M2.9 (#4) Screw Size  
Panel Range: .7mm - 1.5mm  
Center of Hole to Edge: 4mm  
UNIT PACKAGE: 50



**20649**  
Zinc & Yellow

M3.5 (#6) Screw Size  
Panel Range: .5mm - 1.5mm  
Center of Hole to Edge: 8mm  
UNIT PACKAGE: 50



**13223**  
(BMW: 0712-9-925-708;  
Mercedes: 000-994-25-45)  
Plated

"U" Type Nut  
4.2mm (#8) Screw Size  
Panel Range: 3mm-4mm  
Center of Hole To Edge: 7mm  
UNIT PACKAGE: 50

# Sec. 22 MERCEDES-BENZ CLIPS & FASTENERS



## 13224

(000-994-04-45)  
Plated

"U" Type Nut  
4.2mm (#8) Screw Size  
Panel Range: .5mm-1.7mm  
Center of Hole To Edge: 8mm

UNIT PACKAGE: 50



## 13215

(BMW: 0711-9-916-945,  
Mercedes 000-994-14-45)  
Plated

"U" Type Nut  
4.8mm Screw Size  
Panel Range: .8mm-1.7mm  
Center Of Hole To Edge: 11mm

UNIT PACKAGE: 50



## 13222

(Mercedes 000-994-50-45;  
BMW 0712-9-925-730;  
VW: N15.457.1;  
Opel: 20-72-175)  
Plated

6.5mm Screw Size  
Panel Range: .7mm-1.5mm  
Center of Hole to Edge: 13mm

UNIT PACKAGE: 50



## 20650

(123-994-08-45)  
Zinc & Yellow

M4.2 (#8) Screw Size  
Panel Range: .5mm - 2.5mm  
Center of Hole to Edge: 14mm

UNIT PACKAGE: 25



## 13216

Zinc

"U" Type Nut  
4.8mm Screw Size  
Panel Range: .9mm-2.0mm  
Center of Hole to Edge: 8mm

UNIT PACKAGE: 25

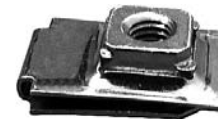

## 20651

(001-990-00-91)  
Zinc & Yellow

M6 - 1.0 Screw Size  
Panel Range: .5mm - 1.7mm  
Center of Hole To Edge: 15mm

UNIT PACKAGE: 10



## 13218

(BMW: 0712-9-925-737;  
Mercedes 000-994-06-45)  
Plated

"U" Type Nut  
4.8mm Screw Size  
Panel Range: .5mm-1.7mm  
Center of Hole To Edge: 7mm

UNIT PACKAGE: 50



## 13220

(Mercedes:  
000-994-09-45;  
Volvo: 946-418;  
Opel: 20-72-175)  
Plated

"U" Type Nut  
6.3mm Screw Size  
Panel Range: .7mm-1.5mm  
Center of Hole To Edge: 13mm

UNIT PACKAGE: 50

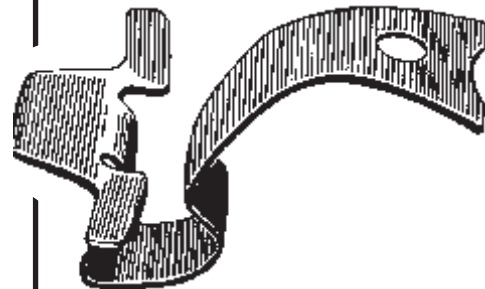

## 13149

(123-401-01-28)  
Plated Metal

Hub Cap Clip  
UNIT PACKAGE: 10



**19343**  
(MB608137)  
Natural Nylon

Windshield Moulding Clip  
Diamante  
1995-91

UNIT PACKAGE: 15



**19475**  
(MB608156)  
Natural Nylon

Windshield Moulding Clip  
With Adhesive Backing  
Diamante  
1996-91

UNIT PACKAGE: 10



**19314**  
(MB814419)  
Nylon

Drip Moulding  
& Garnish  
Moulding Clip  
Galant  
1993-On

UNIT PACKAGE: 25

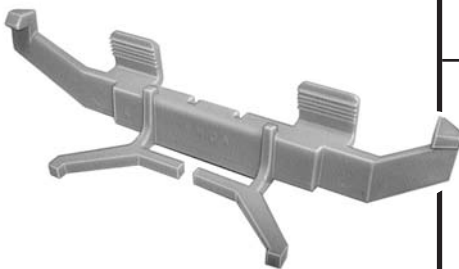

**19473**  
(MR154127)  
Teal Nylon

Windshield Moulding Clip  
Diamante  
1997-On

UNIT PACKAGE: 10



**19342**  
(MB608134)  
Nylon

Windshield & Rear Window  
Reveal Moulding Clip  
Diamante  
1995-91

UNIT PACKAGE: 15



**17195**  
Black Nylon

Grille Clip  
13mm Wide  
22mm Long  
Ford Escort, Honda,  
Isuzu, Mitsubishi & Plymouth Laser

UNIT PACKAGE: 25



**19474**  
(MR154128)  
Natural Nylon

Windshield Moulding Clip  
Diamante  
1997-On

UNIT PACKAGE: 15



**17295**  
(MB-198536)  
Nylon

Windshield Moulding Clip  
Mitsubishi 1984-On  
Dodge Conquest 1984-On

UNIT PACKAGE: 25



**19745**  
(MB880455)  
Yellow Nylon

Windshield Moulding Clip  
Montero  
1992-On

UNIT PACKAGE: 10



**20572**  
(MB846992)  
White Nylon

Rocker Panel Retainer  
Top Head Diameter: 12mm  
Bottom Head Diameter: 16mm  
Stem Length: 14mm  
Fits Into 7mm Hole  
Montero  
2001 - On

UNIT PACKAGE: 10



**19330**

(MB608140)  
White Nylon

Trunk Air Dam  
Side Moulding Clip  
Diamante  
1991-On

UNIT PACKAGE: 10



**14255**

(Mitsubishi: MS-480001;  
Honda: 75522-611-0000;  
Mazda: 9991-00-412)  
Black Nylon

#8 Screw Size  
9.5mm Wide  
9.5mm Long  
Snaps Into 7mm x 7mm Hole

UNIT PACKAGE: 50



**19487**

(MB419858)  
Natural Nylon

Scuff Plate Screw Grommet  
#6 Screw Size  
Diamante  
1995-91

UNIT PACKAGE: 15



**13932**

(Mitsubishi: MS-480002;  
Toyota: 90189-05013)  
Natural Nylon

#10 Screw Size  
12mm Wide  
12mm Long  
Fits Into 8mm x 9mm Hole

UNIT PACKAGE: 50



**19485**

Natural Nylon

#14 (M6.3) Screw Size  
Fits Into 3/8" x 3/8" Hole  
Eclipse

UNIT PACKAGE: 10



**20573**

(MB817060)  
White Nylon

Headliner Nylon Nut  
Head Diameter: 15mm  
Inside Diameter: 6mm  
Stem Length: 11mm  
Fits Into 9mm Hole  
Montero  
1997 - On

UNIT PACKAGE: 15



**14335**

(Mitsubishi: MB-106212;  
Nissan: 96706-H9400,  
-K1300,-K1351)  
Natural Nylon

Screw Grommet  
#8 Screw Size  
Head Diameter: 13.5mm  
Stem Length: 16mm  
Fits Into 6mm x 6mm Hole

UNIT PACKAGE: 50



**14695**

(Mitsubishi: MS-480012;  
Honda: 90661-SC7-0030;  
Mazda: H001-50-841;  
Nissan: 01651-00481, 74798-S9000;  
Toyota: 90189-06042)  
White Nylon

Screw Grommet  
#8 Screw Size  
Head Diameter: 16mm  
Stem Length: 17mm  
Fits Into 8mm x 8mm Hole

UNIT PACKAGE: 25



**19322**

(MU480034)  
Natural Nylon

Rear Side & Trunk Trim  
Screw Grommet  
#8 Screw Size  
Eclipse  
1994-On

UNIT PACKAGE: 15





## 14275

(Mitsubishi: MB-098145;  
Nissan: 01281-00023;  
Toyota: 90189-06001)  
White Nylon

Screw Grommet  
#10 Screw Size  
Head Diameter: 18mm  
Stem Length: 17mm  
Fits Into 8.5mm x 8.5mm Hole  
UNIT PACKAGE: 25



## 19324

(MB888561)  
Natural Nylon

Drip Moulding Screw Grommet  
#8 Screw Size  
Eclipse  
1994-On  
UNIT PACKAGE: 25



## 20381

(Honda: 90667-671-013ZA;  
Mitsubishi: MC440901;  
Nissan: 62660-48600-1)  
Black Nylon

Trim Panel Retaining Clip  
Head Diameter: 16mm  
Stem Diameter: 7mm  
Stem Length: 16mm  
Honda, Mitsubishi &  
Nissan  
UNIT PACKAGE: 25



## 20581

(MR478263)  
Black Rubber

Bumper Cover &  
Garnish Moulding Grommet  
With Sealer  
Head Diameter: 16mm  
Stem Length: 20mm  
Fits Into 9mm Hole  
**Use With Auveco 20580**  
Chrysler Sebring & Stratus  
And Mitsubishi Eclipse  
2000 - On  
UNIT PACKAGE: 15



## 19329

(MB361578)  
White Nylon

Side Air Dam  
Screw Grommet  
#8 Screw Size  
Diamante & Eclipse  
1989-On  
UNIT PACKAGE: 15

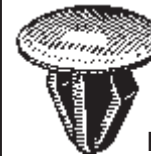

## 14720

(HB-121467)  
Black Nylon

Retaining Clip  
Head Diameter: 18mm  
Shank Length: 15mm  
Snaps Into 8mm Hole  
Panel Thickness: 5mm  
UNIT PACKAGE: 25



## 19332

(MB417490)  
Gray Nylon

Headliner Retainer  
Head Diameter: 22mm  
Stem Diameter: 6.5mm Sq.  
Stem Length: 12mm  
Eclipse & Galant  
1994-On  
UNIT PACKAGE: 15



## 19323

(MU481187)  
Black Nylon

Hood Insulation Retainer  
Head Diameter: 26mm  
Stem Diameter: 10mm  
Stem Length: 8mm  
Diamante  
1993-On  
UNIT PACKAGE: 15



## 20565

(MB271999)  
Black Nylon

Bumper Cover Grommet  
Head Diameter: 24mm  
Stem Length: 21mm  
Fits into 13mm Hole  
Chrysler Colt, Eagle, Sebring  
& Stratus 1989 - On  
Mitsubishi Eclipse, Galant  
& Mirage 1993 - On  
UNIT PACKAGE: 10



## 19331

(MB869072)  
Black Nylon

Headliner & Trunk Trim  
Retaining Clip  
Head Diameter: 14mm  
Stem Length: 11mm  
Fits Into 7mm Hole  
Diamante  
1995-91  
UNIT PACKAGE: 15



## 19385

(MB020923)  
Gray Nylon

Hood Insulation Retainer  
Head Diameter: 26mm  
Stem Diameter: 10mm  
Stem Length: 8mm  
Jeep Eagle &  
Mitsubishi Eclipse  
1992-On  
UNIT PACKAGE: 10



**19334**

(MB566720)  
Natural Nylon

Rear Pillar Trim &  
Air Inlet Grille Retainer  
Small Head Diameter: 12mm  
Large Head Diameter: 16mm  
Stem Diameter: 9mm  
Stem Length: 15  
Eclipse  
1994-On

UNIT PACKAGE: 15



**19320**

(MB696120)  
White Nylon

Side Garnish &  
Moulding Trim Retainer  
Small Head Diameter: 12mm  
Large Head Diameter: 16mm  
Stem Diameter: 9mm  
Stem Length: 11mm  
Eclipse  
1994-On

UNIT PACKAGE: 15



**20571**

(MR435918)  
White Nylon

Rocker Panel Retainer  
Top Head Diameter: 13mm  
Bottom Head Diameter: 18mm  
Stem Diameter: 9mm  
Stem Length: 9mm  
Montero  
2001 - On

UNIT PACKAGE: 15



**19321**

(MB692000)  
White Nylon

Pillar Trim Retainer  
Head Size: 13mm x 14mm  
Stem Diameter: 9mm  
Stem Length: 16mm  
Galant  
1993-On

UNIT PACKAGE: 15



**19325**

(MU481027)  
Brown Nylon

Hood Weatherstrip  
Retainer  
Head Size: 5mm x 13mm  
Stem Diameter: 7mm  
Stem Length: 6mm  
Eclipse & Diamante  
1991-On

UNIT PACKAGE: 25



**20580**

(MR478262)  
Black Nylon

Bumper Cover &  
Garnish Moulding  
Push-Type Retainer  
Top Head Diameter: 15mm  
Bottom Head Diameter: 14mm  
Stem Length: 12mm  
Fits Into 7mm Hole

**Use With Auveco 20581**  
Chrysler Sebring & Stratus  
And Mitsubishi Eclipse  
2000 - On

UNIT PACKAGE: 15



**19239**

(Honda: 91512-SX0-003;  
Mitsubishi: MU000319)  
Black Nylon

Front Fender &  
Bumper Support  
Push-Type Retainer  
Head Diameter: 20mm  
Stem Length: 11mm  
Fits Into 8mm Hole  
Acura 3.5RL, Honda Accord,  
Prelude & Odyssey  
1994-On  
Mitsubishi Lancer  
2002-On

UNIT PACKAGE: 25



**20247**

(MR200300)  
Black Nylon

Fender & Bumper  
Push-Type Retainer  
Head Diameter: 18mm  
Stem Length: 12mm  
Fits Into 9mm Hole  
Honda & Mitsubishi  
1998 - On

UNIT PACKAGE; 15



**17351**

(MB-253964)  
Black Nylon

Front & Rear Bumper  
Push-Type Retainer  
Head Diameter: 17mm  
Stem Length: 10mm  
Fits Into 7mm Hole  
Tredia 1988-83

UNIT PACKAGE: 10



**17472**  
 (Mitsubishi: MB547806;  
 Nissan: 63854-01A00)  
 Black Nylon  
 Front Bumper Fascia  
 Push-Type Retainer  
 Head Diameter: 20mm  
 Stem Length: 20mm  
 Fits Into 8mm Hole

UNIT PACKAGE: 15



**19140**  
 (Acura: 90505-SL0-003;  
 GM: 94852638;  
 Mitsubishi: MB888869;  
 Toyota: 90467-08155)  
 Black Nylon  
 Push-Type Retainer  
 Head Diameter: 20mm  
 Stem Length: 21mm  
 Fits Into 8mm Hole  
 Acura, Dodge Avenger,  
 Eagle Talon, Geo Prizm, Mitsubishi  
 Eclipse & Galant  
 and Toyota 1993-On

UNIT PACKAGE: 5



**18951**  
 (MR-138807)  
 Black Nylon  
 Front Bumper  
 & Support  
 Push-Type Retainer  
 Head Diameter: 20mm  
 Stem Length: 26mm  
 Fits Into 8mm Hole  
 Eclipse 1994-On

UNIT PACKAGE: 5



**19328**  
 (MR201466)  
 White Nylon  
 Trunk Trim Cap  
 Eclipse  
 1994-On

UNIT PACKAGE: 15



**14735**  
 (Mitsubishi: AA-000000;  
 Toyota: 90463-10338)  
 Nylon

Cable Strap  
 Length: 80mm (3-1/8")  
 Max. Bundle  
 Diameter: 12mm  
 Fits Into 7mm Hole

UNIT PACKAGE: 25



Not Actual Size

**20380**  
 Not Supplied By O.E.M.  
 Black Nylon

Cable Strap  
 Length: 200mm (8")  
 Max. Bundle Dia: 44mm (1-3/4")  
 Fits Into 6.3mm (1/4") Hole  
 Import Cars

UNIT PACKAGE: 25



**13225**  
 Plated

"U" Type Nut  
 4.2mm (#8) Screw Size  
 11mm Wide 16.5mm Long  
 Panel Range: .5mm-2.5mm  
 Center of Hole to Edge: 8mm

UNIT PACKAGE: 50



**16557**  
(26024-H8610)

Headlight Adjusting Spring  
UNIT PACKAGE: 10



**12585**  
(255 Y 3616-10)  
Nylon

Side Window Moulding Clip  
12mm Wide  
12mm Long  
Snaps Into 5mm Hole

UNIT PACKAGE: 15



**15468**  
(72826-01P00)  
Nylon

Windshield Moulding Clip  
11mm Wide, 40mm Long  
300ZX 1984-On

UNIT PACKAGE: 15



**19750**  
(01553-08911)  
White Nylon

Body Side Moulding Clip  
Top Head Size: 12mm x 15mm  
Bottom Head Diameter: 16mm  
Stem Diameter: 8mm x 8mm  
Stem Length: 12mm  
Maxima & Sentra  
1994 - On

UNIT PACKAGE: 10



**20674**  
(85284-AD005)  
Black Nylon

Rear Bumper Retainer  
With Sealer  
Head Diameter: 18mm  
Stem Length: 21mm  
Overall Length: 38mm  
Quest  
2004 - On

UNIT PACKAGE: 10



**17348**  
(73856-51E00)  
Nylon

Roof Side Moulding Clip  
Stanza 1990-On

UNIT PACKAGE: 25



**20614**  
(66820-3S510)  
White Nylon

Cowl Vent Retainer  
Head Size: 10mm x 18mm  
Stem Diameter: 6mm  
Stem Length: 13mm  
Frontier & Xterra  
1998 - On

UNIT PACKAGE: 25



**14333**  
(79896-P7100)  
Nylon

Moulding Clip  
27mm Wide; 25mm Long  
Fits Into 14mm x 16mm Hole

UNIT PACKAGE: 10



**15469**  
Nylon

Windshield Reveal Moulding Clip  
15mm Wide, 25.5mm Long  
Nissan & Mazda

UNIT PACKAGE: 25



**17349**  
(79796-71E00)  
Nylon

Window Reveal Moulding Clip  
Back Glass  
Maxima  
1990-On

UNIT PACKAGE: 25



**12583**  
(76884-90100)  
Nylon

Step Moulding Clip  
24mm Wide  
14mm Long  
Snaps Into 8mm Hole

UNIT PACKAGE: 15



**16822**  
(80866-01A00)  
Nylon

Windshield Reveal Moulding Clip  
16mm Wide, 34mm Long  
Snaps Into 7mm Square Hole

UNIT PACKAGE: 25

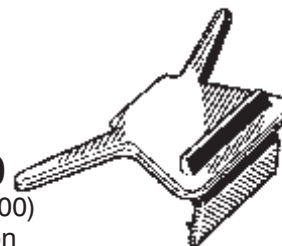

**15470**  
(72727-W1000)  
White Nylon

Windshield Reveal Moulding Clip  
21mm Wide, 40mm Long

UNIT PACKAGE: 15

# NISSAN CLIPS & FASTENERS

**Sec. 22**

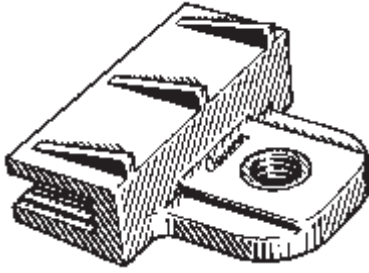

**18113**  
(69951-12180)  
Nylon With  
Steel Threaded Insert

Glass Mount  
M6-1.0 Thread  
Nissan, Ford & Imports

UNIT PACKAGE: 5

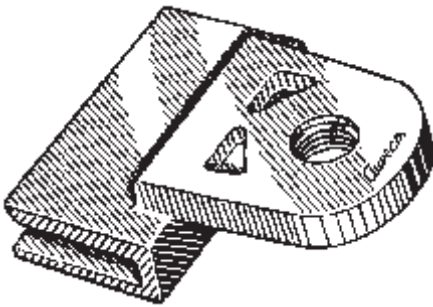

**17479**

Nylon With Steel Threaded Insert

Glass Mount  
M6-1.0 Thread  
720 Truck 1986-80

UNIT PACKAGE: 2

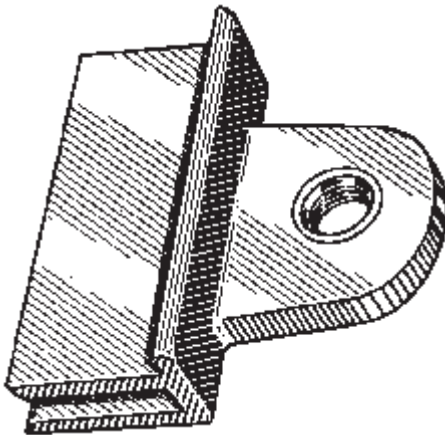

**17480**

Nylon With Steel Threaded Insert

Glass Mount  
M6-1.0 Thread  
Pathfinder & 850 Pick-Up Truck  
1986-On

UNIT PACKAGE: 2



**16549**  
(26025-N8500)  
Black Nylon

Headlight Adjusting Screw Nut  
200SX, 210,  
620 & 720 1980-On

UNIT PACKAGE: 25



**13931**  
(26023-H1000)  
White Nylon

Screw Grommet  
For Headlight Adjusting Screws  
Use With 5mm Screws  
14mm Wide  
14mm Long

UNIT PACKAGE: 50



**13930**

(Nissan: 96706-B0700;  
Mazda: 9991-00-412)  
White Nylon

#8 Screw Size  
9.5mm Wide 9.5mm Long  
Snaps Into 7mm x 7mm Hole

UNIT PACKAGE: 50



**14274**

(Mazda: 9991-00-601;  
Honda: 75521-611-0000;  
Nissan: 96706-P0105;  
Toyota: 90189-06010)  
Natural Nylon

#10 Screw Size  
13mm Wide; 13mm Long  
Snaps Into 8.5mm x 8.5mm Hole

UNIT PACKAGE: 25



**19897**

(76881-9E000)  
Green Nylon

Door Panel Sash  
Screw Grommet  
M4.2 (#8) Screw Size  
Head Size: 10mm Sq.  
Stem Length: 8mm  
Maxima  
1999 - On

UNIT PACKAGE: 25



**14334**  
(96706-N8000)  
Natural Nylon

#8 Screw Size  
12mm Wide; 15mm Long  
Fits Into 8mm x 12mm Hole

UNIT PACKAGE: 25



**14313**

(Nissan: 68425-H5000;  
Honda: 90662-671-0030;  
Mazda: 9991-00-503)  
Natural Nylon

#10 Screw Size  
17mm Wide; 17mm Long  
Snaps Into 8mm x 8.5mm Hole

UNIT PACKAGE: 25



**14331**

(01281-00022)  
Natural Nylon

#10 Screw Size  
Head Diameter: 13mm  
Fits Into 8mm x 8mm Hole

UNIT PACKAGE: 50



**17342**

(01281-00441)  
Black Nylon

Front Bumper Apron  
Nylon Nut  
#10 Screw Size  
15mm Head Diameter  
Snaps Into 8mm x 8mm Hole  
Stanza  
1990-On

UNIT PACKAGE: 25



**20266**

(62319-0W000)  
Natural Nylon

Front Bumper  
Nylon Nut  
Head Dia: 16mm  
Stem Length: 11mm  
M5.5 (#12) Screw Size  
Frontier Truck  
1997 - On

UNIT PACKAGE: 10



**20673**  
(80874-0P000)  
White Nylon

Cowl Vent Grommet  
With Sealer  
Head Size: 13mm x 13mm  
Stem Length: 13mm  
**Use With Auveco 17633**  
Nissan & Infiniti  
1997 - On  
UNIT PACKAGE: 15



**14335**  
(Nissan: 96706-H9400;  
-K1300, -K1351;  
Mitsubishi: MB-106212)  
Natural Nylon

Screw Grommet  
#4 Screw Size  
Head Diameter: 13.5mm  
Stem Length: 16mm  
Fits Into 6mm x 6mm Hole  
UNIT PACKAGE: 50



**14275**  
(Nissan: 01281-00023;  
Mitsubishi: MB-098145;  
Toyota: 90189-06001)  
White Nylon

Screw Grommet  
#10 Screw Size  
Head Diameter: 18mm  
Stem Length: 17mm  
Fits Into 8.5mm x 8.5mm Hole  
UNIT PACKAGE: 25



**20257**  
(76848-50Y00)  
Blue Nylon

Windshield Moulding  
Screw Grommet  
Head Size: 12mm x 16mm  
Stem Length: 12mm  
M3.5 (#6) Screw Size  
Maxima  
1999 - On  
UNIT PACKAGE: 10



**20258**  
(01281-00741)  
Natural Nylon

Floor Trim  
Screw Grommet  
Head Dia: 11mm  
Stem Length: 13mm  
M3.5 (#6) Screw Size  
Quest  
1998 - On  
UNIT PACKAGE: 10



**19293**  
(01281-00601)  
Natural Nylon

Body Side Moulding  
Floor & Trunk  
Screw Grommet  
#10 Screw Size  
Maxima, Sentra,  
240SX & 300ZX  
1986-On  
UNIT PACKAGE: 15



**14724**  
(96706-H2500)  
Natural Nylon

Screw Grommet  
#6 Screw Size  
Head Diameter: 11.5mm  
Stem Diameter: 9.5mm  
Fits Into 7mm x 7mm Hole  
UNIT PACKAGE: 25



**14695**  
(Nissan: 01651-00481  
74798-S9000;  
Honda: 90661-SC7-0030;  
Mazda: H001-50-841;  
Mitsubishi: MS-480012;  
Toyota: 90189-06042)  
White Nylon

Screw Grommet  
#8 Screw Size  
Head Diameter: 16mm  
Stem Length: 17mm  
Fits Into 8mm x 8mm Hole  
UNIT PACKAGE: 25



**19685**  
(76848-35F00)  
White Nylon

Side Moulding Grommet  
Flange Diameter: 18mm  
Stem Length: 14mm  
Fits Into 7mm Hole  
Altima 1992 - On  
UNIT PACKAGE: 15



**20168**  
(76848-35F20)  
Black Nylon

Mudguard Grommet  
Head Diameter: 18mm  
Stem Length: 14mm  
Fits Into 7mm Hole  
Sentra  
1997 - On  
UNIT PACKAGE: 15



**14366**  
(Nissan: 96706-89901;  
Mazda: 9991-00-402)  
Natural Nylon

Screw Grommet  
#6 Screw Size  
9.5mm Wide; 9.5mm Long  
Stem Length: 16mm  
Fits Into 7mm x 7mm Hole  
UNIT PACKAGE: 50



**20604**  
(01281-00711)  
Natural Nylon

Rocker Moulding  
Screw Grommet  
M4.2 (#8) Screw Size  
Head Diameter: 20mm  
Stem Length: 15mm  
Nissan & Infiniti  
1995 - On  
UNIT PACKAGE: 10

# NISSAN CLIPS & FASTENERS

**Sec. 22**



**14690**

(Nissan: 78856-R4301,  
Honda: 90683-693-0000)  
White Nylon

Screw Grommet  
#10 Screw Size  
12mm Wide; 19mm Long  
Stem Length: 17mm  
Fits Into 8mm x 15mm Hole  
UNIT PACKAGE: 25



**20166**

(76881-0P000)  
Natural Nylon

Window Moulding  
Screw Grommet  
#8 Screw Size  
Head Size: 16mm x 22mm  
Stem Length: 16mm  
Sentra & Stanza  
1994 - On  
UNIT PACKAGE: 15



**17196**

(62380-U7400)  
Black Nylon

Grille Grommet  
22mm Wide, 26mm Long  
Nissan 1987-On  
UNIT PACKAGE: 10



**19736**

(76988-3J000)  
White Nylon

Kick Plate Retainer Grommet  
Head Size: 14mm x 34mm  
Stem Length: 14mm  
Altima  
1997-On  
UNIT PACKAGE: 15



**17633**

(66820-88E00)  
Nylon

Cowl Screen Pin Retainer  
Maxima 1990-On  
UNIT PACKAGE: 25



**19146**

(01281-00481)  
Natural Nylon

Front Windshield  
Moulding Grommet  
#6 Screw Size  
Pathfinder & Truck  
1986-On  
UNIT PACKAGE: 10



**19292**

(01281-00501)  
Natural Nylon

Body Side Fitting  
Screw Grommet  
#6 Screw Size  
Stanza  
1994-86  
UNIT PACKAGE: 15



**17634**

(01553-01781)  
Black Nylon

Cowl Grille Retainer  
Head Dia: 12mm  
Stem Length: 16mm  
Stem Dia: 6mm  
240SX  
1990-On  
UNIT PACKAGE: 25



**14355**

(01553-00401)  
Black Nylon

Retaining Clip  
Head Diameter: 11mm  
Stem Length: 13mm  
Snaps Into 5mm Hole  
Panel Range: 4mm  
UNIT PACKAGE: 50



**14349**

(Mazda: 9926-40-543A;  
Nissan: 01553-00291)  
Black Nylon

Retaining Clip  
Head Diameter: 11mm  
Stem Length: 15mm  
Fits Into 5.5mm Hole  
Panel Thickness: 5mm  
UNIT PACKAGE: 50



**14352**

(76876-W5000)  
Black Nylon

Retaining Clip  
Head Diameter: 13mm  
Stem Length: 13mm  
Fits Into 5mm Hole  
Panel Thickness: 4mm  
UNIT PACKAGE: 50



**17452**

(01553-00545)  
White Nylon

Bumper Fascia Retainer  
Head Diameter: 13mm  
Stem Length: 15mm  
Fits Into 5mm Hole  
Sentra  
1990-On  
UNIT PACKAGE: 25



**14737**

(Nissan: 01553-00172;  
Toyota: 90467-07050)  
Black Nylon

Retaining Clip  
Head Diameter: 13mm  
Stem Length: 15mm  
Fits Into 5mm Hole  
Panel Thickness: 3mm  
UNIT PACKAGE: 25



**14723**  
(62869-N4700)  
Black Nylon

Retaining Clip  
Head Diameter: 14mm  
Stem Length: 11mm  
Fits Into 6mm Hole  
Panel Thickness: 4mm  
UNIT PACKAGE: 25



**14347**  
(01553-00202)  
Black Nylon

Retaining Clip  
Head Diameter: 18mm  
Stem Length: 12mm  
Snaps Into 7mm Hole  
Panel Thickness: 4mm  
UNIT PACKAGE: 50



**16776**  
(Honda: 90667-SA0-0030;  
Nissan: 76996-01P02)  
Black Nylon

Trim Panel Retainer  
Head Dia: 18mm  
Stem Length: 20mm  
Fits Into 6mm Hole  
UNIT PACKAGE: 25



**14353**  
(76906-T3000)  
Black Nylon

Retaining Clip  
Head Diameter: 14mm  
Stem Length: 16mm  
Snaps Into 6mm Hole  
Panel Thickness: 5mm  
UNIT PACKAGE: 50



**20671**  
(01553-0052U)  
Black Nylon

Trim Panel Retaining Clip  
Head Diameter: 20mm  
Stem Diameter: 9.5mm  
Stem Length: 15mm  
Frontier & Xterra  
2000 - On  
UNIT PACKAGE: 25

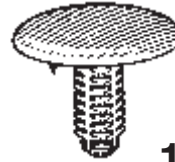

**16775**  
(Honda: 90667-SA7-0030;  
Nissan: 89427-98070)  
Black Nylon

Trim Panel Retainer  
Head Dia: 20mm  
Stem Length: 15mm  
Fits Into 5mm Hole  
UNIT PACKAGE: 25



**14348**  
(27948-M7002)  
Black Nylon

Retaining Clip  
Head Diameter: 16mm  
Stem Length: 15mm  
Snaps Into 5mm Hole  
Panel Thickness: 4mm  
UNIT PACKAGE: 25



**14356**  
(01553-00051)  
Black Nylon

Retaining Clip  
Head Diameter: 20mm  
Stem Length: 16mm  
Snaps Into 7mm Hole  
Panel Thickness: 7mm  
UNIT PACKAGE: 50



**20167**  
(01553-02041)  
Black Nylon

Splash Shield Retainer  
Head Diameter: 22mm  
Stem Diameter: 6mm Sq.  
Stem Length: 16mm  
Frontier  
1997 - On  
UNIT PACKAGE: 25

UNIT PACKAGE: 25



**20381**  
(Honda: 90667-671-013ZA;  
Mitsubishi: MC440901;  
Nissan: 62660-48600-1)  
Black Nylon

Trim Panel Retaining Clip  
Head Diameter: 16mm  
Stem Diameter: 7mm  
Stem Length: 16mm  
Honda, Mitsubishi & Nissan  
UNIT PACKAGE: 25



**20256**  
(01553-01182)  
Black Nylon

Splash Shield Retainer  
Head Dia: 15mm  
Stem Dia: 4.5mm  
Stem Length: 14mm  
Frontier Truck  
1997 - On  
UNIT PACKAGE: 50

UNIT PACKAGE: 50



**17237**  
(65832-F5000,  
65846-30F00)  
Black Nylon

Hood Insulation Retainer  
O.D.: 38mm  
Stem Dia: 7mm  
Stem Length: 9mm  
Nissan 1981-On  
UNIT PACKAGE: 15

UNIT PACKAGE: 15





**20672**  
(66820-3S500-C1)  
White Nylon

Cowl Vent Retainer  
Top Head Diameter: 13mm  
Bottom Head Diameter: 16mm  
Stem Diameter: 4mm  
Stem Length: 13mm  
Frontier & Xterra  
1998 - On

UNIT PACKAGE: 25



**19731**  
(84915-0W000)  
White Nylon

Trim Panel Retainer  
Top Head: 13mm  
Middle Head: 16mm  
Bottom Head: 17mm  
Fits Into 8mm Hole  
Pathfinder  
1995 - On

UNIT PACKAGE: 15

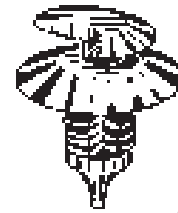

**13945**  
(01553-S3500)  
White Nylon

Door Trim  
Panel Retainer  
Trucks

UNIT PACKAGE: 50



**18166**  
(80875-85E00)  
Black Nylon

Trim Panel Retainer  
Head Diameter: 10mm  
Stem Length: 10mm  
Stem Diameter: 4mm  
Maxima 1989-On

UNIT PACKAGE: 25



**19327**  
(02809-19300)  
Natural Nylon

Body Side Trunk  
Trim Moulding Retainer  
Small Head Diameter: 13mm  
Large Head Diameter: 18mm  
Stem Diameter: 9mm  
Stem Length: 17mm  
Altima, Pulsar,  
Sentra & 240Z  
1986-On

UNIT PACKAGE: 50



**20668**  
(01553-09791)  
White Nylon

Trim Panel Retainer  
Top Head Diameter: 13mm  
Middle Head Diameter: 16mm  
Bottom Head Diameter: 18mm  
Stem Diameter: 9mm  
Stem Length: 14mm  
Nissan & Infiniti  
1999 - On

UNIT PACKAGE: 15



**19724**  
(65810-K2009)  
White Nylon

Hood To Cowl Seal Retainer  
Head Size: 6mm x 16mm  
Stem Length: 15mm  
Fits Into 5mm Hole  
Infiniti & Pathfinder  
1992 - On

UNIT PACKAGE: 25



**20669**  
(01553-07111)  
Black Nylon

Trim Panel Retainer  
Top Head Diameter: 13mm  
Middle Head Diameter: 15mm  
Bottom Head Diameter: 18mm  
Stem Diameter: 9mm  
Stem Length: 15mm  
Nissan Altima and Infiniti G35 & Q45  
1997 - On

UNIT PACKAGE: 25



**20670**  
(01553-02821)  
Gray Nylon

Trim Panel Retainer  
Top Head Diameter: 13mm  
Middle Head Diameter: 16mm  
Bottom Head Diameter: 18mm  
Stem Diameter: 8.5mm  
Stem Length: 12mm  
Maxima  
1988 - On

UNIT PACKAGE: 15



**19684**  
(01553-09311)  
Blue Nylon

Weatherstrip Retainer  
Head Size: 7mm x 16mm  
Stem Length: 12mm  
Fits Into 6mm Hole  
Altima &  
Sentra 1994-On

UNIT PACKAGE: 25

**Remember**  
All Items Are  
Available In Bulk.  
Call For A Quote

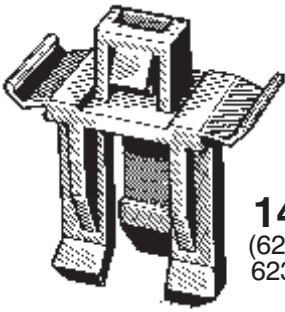

**14729**  
(62350-01M00,  
62350-M7060)  
Nylon

Grille Clip  
14mm Wide  
31mm Long  
37mm High  
Fits Into 8mm x  
10mm Hole

UNIT PACKAGE: 15



**16860**  
(62318-01W00)  
Nylon

Grille Clip  
Dark Gray

UNIT PACKAGE: 25



**14336**  
(82520-E6000)  
Nylon

Retainer  
Head Diameter: 15mm  
Snaps Onto 5mm Rod

UNIT PACKAGE: 25



**19738**  
(80897-10Y00)  
Natural Nylon

Door Panel Clip  
Width: 12mm  
Length: 25mm  
Stem Length: 16mm  
Fits Into 6mm Hole  
Altima, Infiniti & Sentra  
1997 - On

UNIT PACKAGE: 15



**16783**  
(66824-01G00)  
Black Nylon

Push-Type Retainer  
Head Dia.: 12mm  
Stem Length: 8mm  
(Not Including The Pin)  
Fits Into 6mm Hole

UNIT PACKAGE: 25



**19367**  
(01553-06161)  
Black Nylon

Body Side Trimming  
Push-Type Retainer  
Head Diameter: 12mm  
Stem Length: 12mm  
Fits Into 8mm Square  
Hole or Slot  
240SX  
1988-On

UNIT PACKAGE: 15



**16859**  
(Nissan: 66860-01W01;  
GM: 94051993)  
Black Nylon

Cowl Panel To  
Reinforcement Plate &  
Engine Splash Shield Ret.  
Head Dia: 14mm (9/16")  
Stem Length: 16mm (5/8")  
Fits Into 6mm (1/4") Hole  
Nissan 1980-On  
Geo Storm 1990-On

UNIT PACKAGE: 25



**14696**  
(Nissan: 10998-30880;  
Honda: 90684-SA5-0030;  
Isuzu: 8942981190)  
Black Nylon

Push-Type Retainer  
Head Dia: 15mm  
Stem Length: 11mm  
Fits Into 6mm Hole

UNIT PACKAGE: 25



**19432**  
(76882-0B000,  
76882-0B005)  
Black Nylon

Front and Rear Bumper  
Push-Type Retainer  
With Sealer

Head Diameter: 15mm  
Stem Length: 20mm  
Fits Into 8mm Hole  
Quest  
1992-On

UNIT PACKAGE: 15



**18265**  
(76882-57A00)  
Black Nylon

Body Side Moulding  
Push-Type Retainer  
Head Diameter: 16mm  
Stem Length: 20mm  
Fits Into 8mm Hole  
Sentra 1986-On

UNIT PACKAGE: 25



**14726**  
(63844-01A99)  
Black Nylon

Push-Type  
Retainer  
Head Diameter: 17mm  
Stem Length: 18mm  
Fits Into 8mm Hole

UNIT PACKAGE: 25



**16784**  
(Nissan: 80999-05N07;  
Toyota: 90467-07043)  
Black Nylon

Push-Type Retainer  
Head Dia: 18mm  
Stem Length: 11mm  
(Not Including The Pin)  
Fits Into 7mm Hole

UNIT PACKAGE: 25

# NISSAN CLIPS & FASTENERS

**Sec. 22**



**20349**  
(01553-09611)  
Black Nylon

Bumper Clip  
Push-Type Retainer  
Head Diameter: 18mm  
Stem Length: 12mm  
Fits Into 8mm Hole  
Maxima  
1994 - On

UNIT PACKAGE: 15



**20327**  
(63848-9E001)  
Black Nylon

Bumper Fascia  
Push-Type Retainer  
Head Diameter: 18mm  
Stem Length: 22mm  
Fits Into 9mm Hole  
Altima  
1997 - On

UNIT PACKAGE: 10



**20348**  
(63878-01E10)  
Black Nylon

Push-Type Retainer  
Head Diameter: 20mm  
Stem Length: 22mm  
Fits Into 8mm Hole  
Maxima 1994 - On

UNIT PACKAGE: 15



**19246**  
(01553-09241)  
Black Nylon

Bumper  
Push-Type Retainer  
Head Diameter: 18mm  
Stem Length: 15mm  
Fits Into 10mm Hole  
240SX & Maxima  
1994-On

UNIT PACKAGE: 15



**16782**  
(Honda:  
91545-SE0-0030-W;  
Nissan:  
63848-01G00)  
Black Nylon

Push-Type Retainer  
Head Dia: 20mm  
Stem Length; 14mm  
Fits Into 8mm Hole

UNIT PACKAGE: 25



**19905**  
(01553-10051)  
Black Nylon

Push-Type Retainer  
Head Diameter: 20mm  
Stem Length: 8mm  
Fits Into 8mm Hole  
Maxima 1999 - On

UNIT PACKAGE: 15



**20185**  
(01553-09601)  
Brown Nylon

Kick Plate  
Push-Type Retainer  
Head Diameter: 18mm  
Stem Length: 20mm  
Fits Into 9mm Hole  
Frontier Truck  
1997 - On

UNIT PACKAGE: 15



**16858**  
(Nissan: 63844-01A00;  
Ford: MNA01-56145,  
NA01-56145)  
Black Nylon

Inner Fender Retainer  
Head Dia: 20mm (25/32")  
Stem Length: 18mm (23/32")  
Fits Into 8mm (5/16") Hole  
Nissan 1980-On

UNIT PACKAGE: 25



**19274**  
(01553-09321)  
Black Nylon

Push-Type Retainer  
Head Diameter: 20mm  
Stem Length: 9mm  
(Not Including The Pin)  
Fits Into 8mm Hole  
Maxima & 300ZX 1994-On

UNIT PACKAGE: 15



**20613**  
(63848-40Y00)  
Black Nylon

Front Bumper  
Push-Type Retainer  
Head Diameter: 18mm  
Stem Length: 20mm  
Fits Into 9mm Hole  
Frontier & Xterra  
1998 - On

UNIT PACKAGE: 15



**16000**  
(Honda:  
90675-SB3-003;  
Mazda: FB01-56-964;  
Nissan: 63876-95596)  
Black Nylon

Push-Type Retainer  
Head Dia: 20mm  
Stem Length: 9mm  
Fits Into 8mm Hole

UNIT PACKAGE: 25



**17472**  
(Mitsubishi: MB547806;  
Nissan: 63854-01A00)  
Black Nylon

Front Bumper Fascia  
Push-Type Retainer  
Head Diameter: 20mm  
Stem Length: 20mm  
Fits Into 8mm Hole  
300ZX 1990-On

UNIT PACKAGE: 15

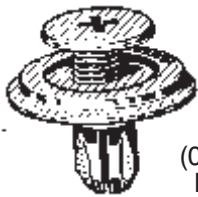

**17378**

(01553-03101)  
Black Nylon

Bumper & Fascia  
Push-Type Retainer  
Head Diameter: 22mm  
Stem Length: 14mm  
Fits Into 11mm Hole  
Nissan 1986-On

UNIT PACKAGE: 15

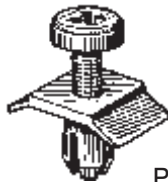

**14725**

(66824-W1000)  
Black Nylon

Push-Type Retainer  
Head Width: 12mm  
Head Length: 18mm  
Stem Length: 10mm  
Fits Into 6mm Hole

UNIT PACKAGE: 15

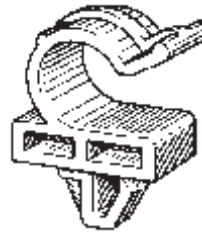

**16780**

(Nissan:  
99604-H1400;  
Toyota:  
58788-13010)

Hood Prop Rod Clip  
Holds 11mm Dia. Rod  
Fits Into 10mm x 12mm Hole

UNIT PACKAGE: 10



**20354**

(622A2-9E000A)  
Black Nylon

Bumper Cover  
Push-Type Retainer  
Head Diameter: 25mm  
Stem Length: 30mm  
Fits Into 8mm Hole  
Altima  
1997 - On

UNIT PACKAGE: 10

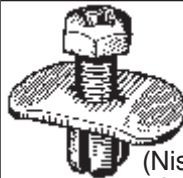

**14727**

(Nissan: 63844-D0100;  
Isuzu: 8942211500)  
Black Nylon

Push-Type Retainer  
5mm x 14mm Screw  
Head Size: 14mm x 22mm  
Stem Length: 9mm  
Fits Into 7mm Hole

UNIT PACKAGE: 25



**14337**

(84653-N7400)  
Nylon

Tube/Cable Routing Clip  
Holds 5mm Tube or Cable  
Snaps Into 5mm Hole

UNIT PACKAGE: 25



**16843**

(Mazda: BF82-50-233;  
Nissan: 01553-01393)  
Black Nylon

Bumper Cover Retainer  
Head Size: 20mm x 30mm  
Stem Length: 18mm  
Fits Into 10mm Hole

UNIT PACKAGE: 10



**14345**

(24220-89986)  
Nylon

Hood Prop  
Rod Clip  
Holds 10mm Rod  
Snaps Into 8mm Hole

UNIT PACKAGE: 10



**17347**

(01553-06721)  
Black Nylon

Front & Rear Bumper  
Cover Push-Type Retainer  
Head Diameter: 20mm  
Stem Length: 15mm  
Fits Into 8mm Hole  
Maxima & Infiniti  
1990-On

UNIT PACKAGE: 15

Not Actual Size



**20380**

Not Supplied By O.E.M.  
Black Nylon

Cable Strap  
Length: 200mm (8")  
Max. Bundle Dia: 44mm (1-3/4")  
Fits Into 6.3mm (1/4") Hole  
Import Cars

UNIT PACKAGE: 25



**16725**

(66814-01G00)  
Black Nylon

Cowl Grille Retainer  
Head Size: 8mm x 12mm  
Stem Length: 8mm  
Fits Into 6mm Square Hole  
Nissan Pick-Up 1986-On

UNIT PACKAGE: 25

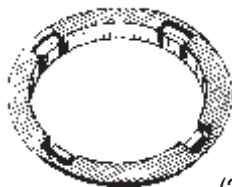

**14346**

(24274-M3000)  
Nylon

Trim Ring  
O.D.: 46mm  
I.D.: 36mm  
Fits Into 40mm Hole

UNIT PACKAGE: 25



## 16340

(54229-0201P)  
Cadmium & Yellow

Window Crank Handle  
Retaining Clip

UNIT PACKAGE: 100



## 17193

(63848-D0100)

Nylon

Nylon "U" Nut  
Fender/Wheel Housing  
#12 Screw Size  
20mm Wide, 20mm Long  
Panel Range: Up to 1mm  
Center Of Hole To Edge: 9mm

UNIT PACKAGE: 15

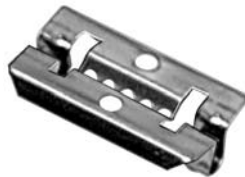

## 19147

(62228-51S00)

Front Bumper Retainer  
300ZX  
1992-On

UNIT PACKAGE: 10



## 19735

(63848-35F00)

Black Nylon

Fender Clip "U" Nut  
#10 Screw Size  
20mm Wide  
32mm Long  
Panel Range: Up To 2mm  
Center Of Hole To Edge: 8mm  
Maxima & 240SX  
1994 - On

UNIT PACKAGE: 15

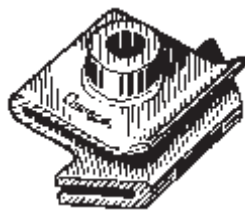

## 17385

(63848-D4000)

Black Nylon

Nylon "U" Nut  
Fender/Wheel Housing Applications  
#12 Screw Size  
31mm Wide; 22mm Long  
Panel Range: Up To 2mm  
Center Of Hole To Edge: 9mm  
Sentra

UNIT PACKAGE: 10



## 13225

Plated

"U" Type Nut  
4.2mm (#8) Screw Size  
11mm Wide  
16.5mm Long  
Panel Range: .5mm-2.5mm  
Center Of Hole To Edge: 8mm

UNIT PACKAGE: 50



**12642**

(1-74-713)

Nylon

Moulding Clip

UNIT PACKAGE: 10



**13207**

(Opel 1-76-651;  
Renault 08-54-699-800)  
Nylon w/Metal Washer

Body Retainer

UNIT PACKAGE: 50



**19153**

(1-74-820, 03467-531)  
Nylon

Moulding Clip

UNIT PACKAGE: 25



**13216**

Zinc

"U" Type Nut  
4.8mm Screw Size  
Panel Range: .9mm-2.0mm  
Center of Hole To Edge: 8mm

UNIT PACKAGE: 25



**13220**

(Mercedes:  
000-994-09-45;  
Volvo: 946-418;  
Opel: 20-72-175)  
Plated

"U" Type Nut  
6.3mm Screw Size  
Panel Range: .7mm-1.5mm  
Center of Hole To Edge: 13mm

UNIT PACKAGE: 50



**13219**

(VW: 311-821-161;  
Opel: 20-72-151)  
Plated

"J" Type Nut  
6.5mm Screw Size  
Panel Range: .7mm-1.5mm  
Center of Hole to Edge: 13mm

UNIT PACKAGE: 50



**13222**

(Mercedes:  
000-994-50-45;  
BMW: 0712-9-925-730;  
VW: N15.457.1; Opel: 20-72-175)  
Plated

"U" Type Nut  
6.5mm Screw Size  
Panel Range: .7mm-1.5mm  
Center of Hole To Edge: 13mm

UNIT PACKAGE: 50

## RENAULT



**13207**

(Opel: 1-76-651;  
Renault: 08-54-699-800)  
Nylon w/Metal Washer

Body Retainer

UNIT PACKAGE: 50



**9377**

(Renault: 8934-201-263;  
Chrysler: 6000943)  
White Nylon

Radiator Grille Nut  
#8 Screw Size

UNIT PACKAGE: 100



**11855**

(Renault: 8934-201-262;  
GM: 9669486)  
Natural Nylon

#8 Screw Size  
Rear License Plate Bracket Nut  
AMC-Renault  
Side Marker Nut  
GM 1980-On

UNIT PACKAGE: 25



**12713**

(GM: 10032838;  
1264963;  
Chrysler: 6031869;  
Renault: 8934-201-602)  
Natural Nylon

High Torque  
Screw Grommet

UNIT PACKAGE: 25



**13464**

(8934-201-235)  
Natural Nylon

Grille Retainer  
Screw Grommet  
4.2mm #8 Screw Size

UNIT PACKAGE: 25



**13966**

(8934-201-767)  
Black Nylon

Tubular Barrel Nut  
For 3/16" Stud  
Barrel Length 17/64"  
Head Dia. 5/16"  
Head Thick 1/32"  
For Hole Dia. 17/64"

UNIT PACKAGE: 100



**12993**

(7703-077-066)  
Black Nylon

Rear Window Moulding Retainer  
Alliance, 1983-On

UNIT PACKAGE: 25



**13475**

(VW: 175-867-299;  
Renault:  
8934-201-681)  
White Nylon

Trim Panel Retainer  
Head Dia: 3/4"  
Stem Length: 3/4"  
Stem Dia: 9/32"  
AMC Renault 1984-On  
VW 1982-On

UNIT PACKAGE: 50



**13216**

Zinc

"U" Type Nut  
4.8mm Screw Size  
Panel Range: .9mm-2mm  
Center of Hole  
To Edge: 8mm

UNIT PACKAGE: 25

## SUBARU



**19799**

(91017AA010)  
Black Nylon

Grille Clip  
Legacy Outback  
1996 - On

UNIT PACKAGE: 10



**16545**

(57754GA190;  
57754GA191)  
Black Nylon

Bumper Fascia Clip  
Head Size: 16mm x 21.5mm  
Stem Diameter: 12mm  
Stem Length: 12mm  
Subaru 1985-On

UNIT PACKAGE: 25

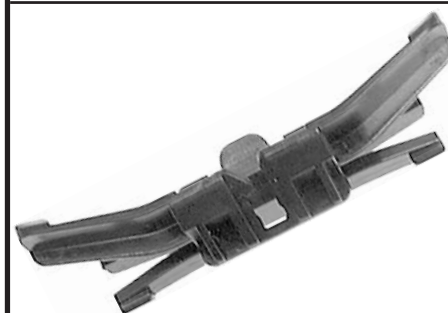

**20370**

(91017-FA010)  
Black Nylon

Windshield Moulding Clip  
Height 15mm,  
Width: 58mm  
Forester & Impreza  
1993 - On

UNIT PACKAGE: 10



**16691**  
Natural Nylon

Headlight Adjusting  
Screw Nut

Pick-Up Truck  
1984-On

UNIT PACKAGE: 25



**16558**  
(81121-14670)

Headlight Adjusting Spring

UNIT PACKAGE: 5



**16951**  
(81124-89101)  
Nylon

Headlight Spacer  
15mm Wide x 18mm Long  
Fits Into 7mm Square Hole  
Pick-Up Truck 1984-On

UNIT PACKAGE: 25



**18747**  
(90189-06162)  
Natural Nylon

Front Clearance Lamp Nut  
Camry 1994-91  
Headlight Adjusting Nut  
Lexus

UNIT PACKAGE: 10

Additional Moulding Fasteners  
Are Listed In The Universal  
Moulding Fastener Section  
Immediately Following  
The Pink Pages.



# TOYOTA CLIPS & FASTENERS

**Sec. 22**



**17194**  
(90467-13005)  
Nylon  
Grille Clip  
13mm Wide  
23mm Long

UNIT PACKAGE: 25



**19671**  
(75398-20050)  
White Nylon  
& Clear Vinyl

Door Moulding Clip  
Sienna Van  
1997 - On

UNIT PACKAGE: 10



**20390**  
(90904-67036)  
Blue Nylon

Fender Moulding Clip  
Head Diameter: 17mm  
Stem Length: 17mm  
Highlander, Land Cruiser,  
Tacoma & Tundra  
2001 - On

UNIT PACKAGE: 10



**17438**  
(90467-17004)  
Nylon  
Radiator  
Grille Clip  
Cressida  
1987-84

UNIT PACKAGE: 10



**19647**  
(90467-11111)  
Red Nylon

Scuff Plate Retainer  
Head Diameter: 18mm  
Stem Diameter: 10mm  
Stem Length: 10mm  
Sienna  
1997-On

UNIT PACKAGE: 10



**20391**  
(90904-67037)  
Red Nylon

Fender Moulding Clip  
Head Diameter: 17mm  
Stem Length: 13mm  
Highlander, Land Cruiser,  
Tacoma & Tundra  
2001 - On

UNIT PACKAGE: 10



**19430**  
(90904-67021)  
Black Nylon  
Radiator Grille Retainer  
T-100 Truck  
1992-On

UNIT PACKAGE: 15



**19797**  
(90467-10077)  
Butterscotch Nylon  
Door Moulding Clip  
With Sealer  
Head Diameter: 15mm  
Stem Length: 9mm  
Fits Into 8mm Hole  
Avalon & Corolla  
1998 - On

UNIT PACKAGE: 15



**20429**  
(90467-11100)  
Yellow Nylon

Fender & Wheel Flare  
Moulding Clip  
Head Dia: 17mm  
Stem Length: 17mm  
Highlander, Land Cruiser,  
Tacoma & Tundra  
2000 - On

UNIT PACKAGE: 10



**15695**  
(Toyota: 62955-20020;  
GM: 94848834)  
Nylon  
Retainer With Sealer  
Head Dia: 15mm  
Stem Length: 9mm  
Fits Into 8mm Hole  
Toyota Pick-Up Truck  
Pontiac Vibe

UNIT PACKAGE: 25



**17481**  
(90467-11063)  
White Nylon

Rocker Panel  
Moulding Clip  
Previa  
1990-On

UNIT PACKAGE: 15



**19843**  
(75498-42010)  
White Nylon

Garnish Clip  
Head Diameter: 20mm  
Stem Length: 20mm  
RAV 4  
1996 - On

UNIT PACKAGE: 10



**20578**

(GM: 88970495,  
Toyota: 76924-52021)

Black Nylon

Rocker Moulding Retainer

Head Diameter: 32mm

Stem Length: 10mm

Fits Into 22mm Hole

Pontiac Vibe & Toyota Corolla  
2003 - On

UNIT PACKAGE: 25

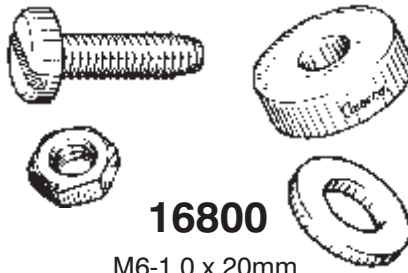

**16800**

M6-1.0 x 20mm

License Plate Hardware

Includes Nylon Screw,  
Washer & Spacer And Brass Nut

UNIT PACKAGE: 25 Sets

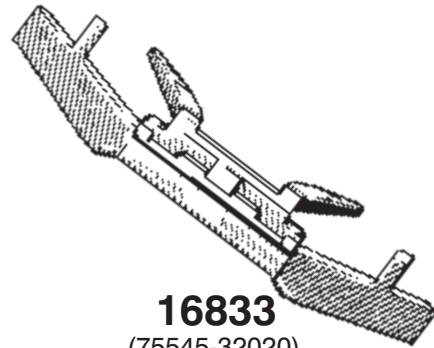

**16833**

(75545-32020)

Nylon

Windshield Moulding Clip

12mm Wide, 66mm Long

Camry 1987-On

UNIT PACKAGE: 10



**19531**

(68211-06020)

Natural Nylon

Door Belt Moulding Clip

Solara

1998-On

UNIT PACKAGE: 25



**17636**

Nylon

License Plate

Bracket Spacer

1/4" (6mm) I.D.

3/4" (19mm) O.D.

1/4" (6mm) Thick

UNIT PACKAGE: 50

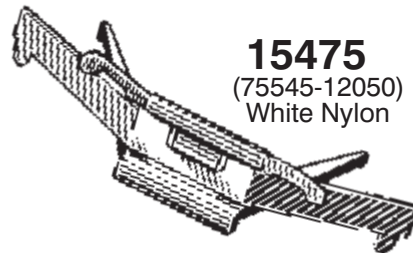

**15475**

(75545-12050)

White Nylon

Windshield Moulding Clip

22mm Wide, 56mm Long

19mm High

Corolla (RWD) 1984-On

UNIT PACKAGE: 10



**19380**

(68211-07010)

Natural Nylon

Door Belt Moulding Clip

Avalon

1994-On

UNIT PACKAGE: 25



**19722**

(68211-95D00)

White Nylon

Door Glass Clip

Previa Van

1990 - On

UNIT PACKAGE: 15



**19204**

(75546-12060)

Natural Nylon

Windshield Moulding Clip

Corolla Sedan Wagon

1992-88

UNIT PACKAGE: 25



**19198**

(68211-32040)

Yellow Nylon

Door Belt Moulding

& Door Weatherstrip Clip

Camry

1991-On

UNIT PACKAGE: 50



**14264**

(75395-14020-A)

Nylon

Moulding Clip

28mm Wide, 14mm Long

Snaps Into 7mm Hole

UNIT PACKAGE: 25

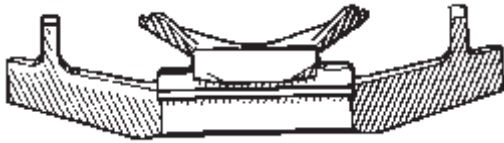

**17300**  
 (75545-20060)  
 Green Nylon  
 Windshield Moulding Clip  
 Celica 1986-On  
 UNIT PACKAGE: 25

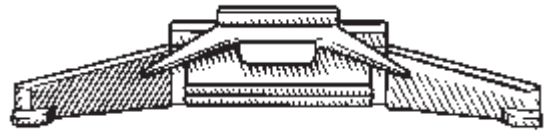

**17334**  
 (75546-22060)  
 Natural Nylon  
 Windshield Side Moulding Clip  
 Cressida 1988-On  
 UNIT PACKAGE: 15



**17301**  
 (75546-20060)  
 Blue Nylon  
 Windshield Moulding Clip  
 Celica 1986-On  
 UNIT PACKAGE: 25



**17485**  
 (75545-32030)  
 Natural Nylon  
 Windshield Moulding Clip  
 Camry 1992-On  
 UNIT PACKAGE: 15



**17302**  
 (75545-89103)  
 Natural Nylon  
 Windshield Side Moulding Clip  
 Without Center Tab  
 Truck 1988-On  
 UNIT PACKAGE: 15



**17303**  
 (75545-89102)  
 Natural Nylon  
 Windshield Side Moulding Clip  
 With Center Tab  
 Truck 1988-On  
 UNIT PACKAGE: 15

Remember...  
 All Items In This  
 Catalog  
 Are Available In Bulk

Call For A Quote.

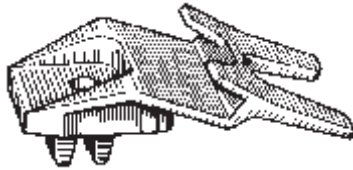

**14746**

(75546-12050)

Nylon

Windshield Moulding Clip  
20mm Wide  
41mm Long  
Fits Into 8mm Hole

UNIT PACKAGE: 15

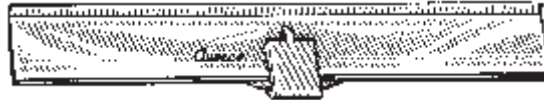

**14731**

(75548-32010)

Nylon

Windshield Clip  
With Adhesive Backing  
14.5mm Wide  
70mm Long

UNIT PACKAGE: 25



**12587**

(75546-12010)

Nylon

Windshield Moulding Clip  
20mm Wide; 40mm Long  
Fits Into 8mm Hole

UNIT PACKAGE: 10



**17330**

(75548-16010)

Nylon

Windshield Moulding Clip  
With Adhesive Backing  
14.5mm Wide, 71mm Long  
Corolla 1988-83

UNIT PACKAGE: 15



**17298**

(75547-22010)

Black Nylon

Windshield Moulding Clip  
20mm Wide, 47mm Long  
1981-On

UNIT PACKAGE: 25

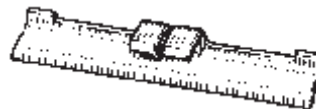

**16819**

(75548-16030)

Nylon

Windshield Moulding Clip  
With Adhesive Backing  
7mm Wide, 40mm Long  
Tercel 1983-On

UNIT PACKAGE: 25

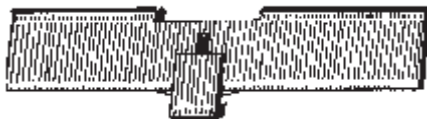

**14278**

(75548-24020)

Nylon

Windshield Clip  
With Adhesive Backing  
14.5mm Wide  
60mm Long

UNIT PACKAGE: 10



**17332**

(75548-20060)

Nylon

Windshield Moulding Clip  
With Adhesive Backing  
8mm Wide, 40mm Long  
Camry, Celica & Supra  
1989-86

UNIT PACKAGE: 10

Note: If an adhesion problem occurs with the adhesive backed clips, warm the back with a heat gun.

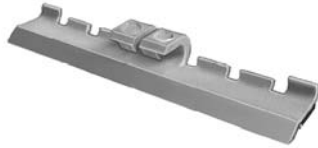

**19484**

(75548-22150)  
Blue Nylon

Windshield Moulding Clip  
With Adhesive Backing  
9mm Wide, 40mm Long  
Cressida  
1988-On

UNIT PACKAGE: 10



**19491**

(75546-89103)  
Nylon

Windshield Moulding Clip  
2WD Truck  
1991 - 88

UNIT PACKAGE: 10



**14744**

(75548-89102)  
Blue Nylon

Windshield  
Moulding Clip With  
Adhesive Backing  
14mm Wide  
40mm Long

UNIT PACKAGE: 10



**14745**

(75546-22050)  
Nylon

Windshield Moulding Clip  
14mm Wide  
47mm Long  
12mm High

UNIT PACKAGE: 25

**You Can E-Mail  
Your New Item Suggestions To  
mail@auveco.com**

When The World Thinks  
Of Body Hardware  
& Specialty Fasteners  
Only One Name Comes To  
Mind....



Note: If an adhesion problem occurs with the adhesive backed clips, warm the back with a heat gun.



**14751**

(75545-16020)  
Nylon

Windshield Moulding Clip  
18mm Wide  
49mm Long  
13mm High

UNIT PACKAGE: 25



**16820**

(75546-12020)  
Nylon

Windshield Moulding Clip  
16mm Wide, 49mm Long  
14mm High  
Corolla 1984-On  
GM Nova 1985-On

UNIT PACKAGE: 25



**19521**

(90189-04217)  
Nylon

Roof Moulding  
Nylon Nut  
#4 Screw Size  
Celica  
1996-93

UNIT PACKAGE: 25



**14749**

(75545-88080;  
75545-28010-B)  
Nylon

Windshield Moulding Clip  
18mm Wide  
49mm Long  
16mm High

UNIT PACKAGE: 25



**16821**

(75546-12030)

Windshield Moulding Clip  
21mm Wide, 54mm Long  
15mm High  
Corolla 1984-On

UNIT PACKAGE: 25



**17224**

(90189-04022,  
95900-04036)  
Nylon

#6 Screw Size  
10mm Wide, 10mm Long  
Snaps Into 7mm x 7mm Hole

UNIT PACKAGE: 50



**14747**

(75545-14081)  
Nylon

Windshield Moulding Clip  
18mm Wide  
50mm Long  
15mm High

UNIT PACKAGE: 25



**16942**

(75545-89101)  
Nylon

Windshield Moulding Clip  
15mm Wide, 47mm Long  
13mm High  
Pick-Up Truck 1984-On

UNIT PACKAGE: 15

Do You Want Your  
Customers To Know You Use  
The Best Body Hardware &  
Specialty Fasteners  
Available?

Promotional Products And  
Apparel Bearing



The Logo Promote Your  
Identity As A Professional.

# TOYOTA CLIPS & FASTENERS

**Sec. 22**



**14271**  
(90189-04011)  
Natural Nylon

#6 Screw Size  
12mm Wide, 12mm Long  
Snaps Into 7mm x 7.5mm Hole

UNIT PACKAGE: 25



**14258**  
(90189-06018)  
Black Nylon

#10 Screw Size  
14mm Wide  
14mm Long  
Snaps Into 9mm x 9mm Hole

UNIT PACKAGE: 25



**19840**  
(90189-04176)  
Natural Nylon

Mudguard Screw Grommet  
#8 (M4.2 - 1.41) Screw Size  
Head Size: 10mm x 10mm  
Stem Length: 15mm  
Toyota Corolla  
1997 - On

UNIT PACKAGE: 15



**19504**  
(90189-04211)  
White Nylon

Front Door Moulding  
Nylon Nut  
#6 Screw Size  
T100 Truck  
1992-On

UNIT PACKAGE: 20



**14739**  
(Toyota: 90189-05012;  
Isuzu: 8941340270)  
Natural Nylon

#6 Screw Size  
16mm Wide  
12mm Long  
Snaps Into 6mm x 10mm Hole

UNIT PACKAGE: 50



**14740**  
(90189-04063)  
White Nylon

Screw Grommet  
#6 Screw Size  
14mm Wide  
14mm Long  
Stem Length: 10mm  
Fits Into 6mm x 6mm Hole

UNIT PACKAGE: 25



**14256**  
(90189-04014)  
Natural Nylon

#8 Screw Size  
10mm Wide, 10mm Long  
Snaps Into 7mm x 7mm Hole

UNIT PACKAGE: 50



**20431**  
(90189-05105)  
Natural Nylon

Front Fender Flare  
Screw Grommet  
Use With M4.2 (#8) Screw  
Head Size: 10mm x 15mm  
Stem Length: 12mm  
RAV 4  
1996 - On

UNIT PACKAGE: 15



**19265**  
(90189-04150)  
White Nylon

Windshield Moulding Screw  
Grommet  
#4 Screw Size  
T100  
1992-On

UNIT PACKAGE: 15



**13932**  
(Toyota: 90189-05013;  
Mitsubishi: MS-480002)  
Natural Nylon

#10 Screw Size  
12mm Wide 12mm Long  
Fits Into 8mm x 9mm Hole

UNIT PACKAGE: 50



**14274**  
(Toyota: 90189-06010;  
Honda: 75521-611-0000;  
Mazda: 9991-00-601;  
Nissan: 96706-P0105)  
Natural Nylon

#10 Screw Size  
13mm Wide 13mm Long  
Snaps Into 8.5mm x 8.5mm Hole

UNIT PACKAGE: 25



**20442**  
(90189-04127)  
Natural Nylon

Door Panel Nylon Nut  
M3.5 (#6) Screw Nut  
Head Size: 14mm x 14mm  
Stem Length: 15mm  
Toyota Tundra  
1999 - On

UNIT PACKAGE: 25



**19783**  
(Ford: N811169-S,  
W705550-S300  
Toyota: 90075-10801,  
90189-06111)  
White Nylon

Head Diameter: 13mm  
Stem Length: 9mm  
Fits Into 11mm Hole  
Ford, Lexus & Toyota

UNIT PACKAGE: 50



**14277**  
(90189-04008,  
90467-12096)  
Black Nylon

Screw Grommet  
#8 Screw Size  
15mm High  
12mm Wide  
16mm Long  
Fits Into 10mm x 10mm Hole  
UNIT PACKAGE: 15



**19841**  
(55799-12010)  
Blue Nylon

Cowl Screw Grommet  
#10 (M4.8) Screw Size  
Fits Into 10mm x 15mm Hole  
Toyota Celica & Corolla  
1997 - On  
UNIT PACKAGE: 10



**14695**  
(Toyota: 90189-06042;  
Honda: 90661-SC7-0030;  
Mazda: H001-50-841;  
Mitsubishi: MS-480012;  
Nissan: 01651-00481,  
74798-S9000)  
White Nylon

Screw Grommet  
#8 Screw Size  
Head Diameter: 16mm  
Stem Length: 17mm  
Fits Into 8mm x 8mm Hole  
UNIT PACKAGE: 25



**18843**  
(90189-04031)  
Natural Nylon

Grille & Rear Filler Nut  
#8 Screw Size  
Camry & Rav 4  
2000 - 1991  
UNIT PACKAGE: 25



**14265**  
(90189-06006)  
Natural Nylon

#10 Screw Size  
Head Diameter: 17mm  
Fits Into 9mm x 9mm Hole  
UNIT PACKAGE: 25



**14275**  
(Toyota: 90189-06001;  
Mitsubishi: MB-098145;  
Nissan: 01281-00023)  
White Nylon

Screw Grommet  
#10 Screw Size  
Head Diameter: 18mm  
Stem Length: 17mm  
Fits into 8.5mm x 8.5mm Hole  
UNIT PACKAGE: 25



**17352**  
(81127-01010,  
81132-32121,  
95900-08025)  
Black Nylon

Headlight Nut  
Fits Into 13mm x 16mm Hole  
Toyota 1988-On  
UNIT PACKAGE: 10



**19187**  
(90189-05082)  
Natural Nylon

Hood Seal To Cowl Top  
Screw Grommet  
#6 Screw Size  
Head Diameter: 13mm  
Stem Length: 13mm  
Fits Into 7mm x 7mm Hole  
2WD & 4WD Truck  
1988-On  
UNIT PACKAGE: 15



**14281**  
(Honda: 90662-693-0030;  
Toyota: 90189-04066)  
White Nylon

Screw Grommet  
#6 Screw Size  
Head Diameter: 14mm  
Stem Length: 10mm  
Fits Into 7mm x 7mm Hole  
UNIT PACKAGE: 25



**18846**  
(53145-16020)  
Black Nylon  
Radiator Grille  
Garnish Grommet  
Tercel  
1990-On

UNIT PACKAGE: 10



**14268**  
(Toyota: 90189-04013;  
Honda:  
90672-671-8110M1)  
Natural Nylon

#6 Screw Size  
Head Diameter: 14mm  
Stem Length: 15mm  
Fits Into 7mm x 7mm Hole  
UNIT PACKAGE: 25



**19505**  
(90189-06029,  
90189-06116)  
Natural Nylon

Rear Door Panel  
Screw Grommet  
#12 Screw Size  
Head Diameter: 18mm  
Stem Length: 17mm  
Fits Into 9mm x 9mm Hole  
Camry & Previa  
1988 - On  
UNIT PACKAGE: 10



**14263**  
(90189-04019)  
Natural Nylon

#8 Screw Size  
12mm Wide, 14mm Long  
Fits Into 6.5mm x 8.5mm Hole  
UNIT PACKAGE: 25



# TOYOTA CLIPS & FASTENERS

**Sec. 22**



**19742**  
(90189-06104)  
Natural Nylon

Fender Lining  
Screw Grommet  
#12 (M5.5) Screw Size  
Head Diameter: 18mm  
Stem Length: 15mm  
Fits Into a 9mm Square Hole  
Lexus IS300 & Toyota Avalon,  
Camry & Sienna  
1997-On

UNIT PACKAGE: 15



**19721**  
(90189-06157)  
Black Nylon

Fender Lining  
Screw Grommet  
#12 Screw Size  
Head Diameter: 20mm  
Stem Length: 22mm  
Fits Into 8mm x 8mm Hole  
Avalon, Camry, Rav 4, Solara &  
Tacoma  
1995-On

UNIT PACKAGE: 15



**14266**  
(90189-06003)  
Nylon

Screw Grommet  
#14 (1/4") Or  
M6.3-1.81 Screw Size  
Head Diameter: 18mm  
Stem Length: 21mm  
Fits Into 8mm x 8mm Hole

UNIT PACKAGE: 15



**19194**  
(Toyota: 90189-06028;  
GM: 94854203)  
Black Nylon

Front & Rear Wheel  
Fender Liner Screw Grommet  
#12 Screw Size  
Head Diameter: 16mm  
Stem Length: 19mm  
Fits Into 9mm x 9mm Hole  
Tacoma, T100 & 4 Runner  
1992-On  
Chevrolet Nova & Prizm  
And Pontiac Vibe  
1985-On

UNIT PACKAGE: 15



**20440**  
(90189-06065)  
Black Nylon

Hood & Fender  
Screw Grommet  
M5.5 (#12) Screw Size  
Head Diameter: 20mm  
Stem Length: 18mm  
Fits Into 9mm x 9mm Hole  
Camry & RAV 4  
1999 - 95

UNIT PACKAGE: 15



**14273**  
(90189-06005)  
White Nylon

Screw Grommet  
#14 (1/4") Or M6.3-1.81 Screw Size  
Head Diameter: 18mm  
Stem Length: 16mm  
Fits Into 8mm x 8mm Hole  
Lexus & Toyota

UNIT PACKAGE: 50



**14267**  
(90189-06013)  
Black Nylon

Screw Grommet  
#14 (1/4") Or M6.3-1.81 Screw Size  
Head Diameter: 20mm  
Stem Length: 17mm  
Fits Into 8mm x 8mm Hole  
Lexus & Toyota

UNIT PACKAGE: 25



**19756**  
(90189-06214)  
Black Nylon

Fender Liner  
Screw Grommet  
#12 (M5.5) Screw Size  
Head Diameter: 16mm  
Stem Length: 18mm  
Sienna, Tacoma & Tundra Pick-Up  
1999 - On

UNIT PACKAGE: 15



**20412**  
(90189-06114)  
White Nylon

Front Fender Liner  
Screw Grommet  
Use With M5.5 (#12) Screw  
Head Dia: 18mm  
Stem Length: 15mm  
Fits Into 9mm Sq. Hole  
RAV 4  
1996 - On

UNIT PACKAGE: 15



**19727**  
(90467-08184)  
White Nylon

Cowl Grommet  
Head Diameter: 15mm  
Stem Length: 10mm  
Fits Into 8mm Hole  
**Use With 20430**  
4 Runner, Pre Runner,  
Tacoma & Tundra  
1995-On

UNIT PACKAGE: 15

**Sec. 22****TOYOTA CLIPS & FASTENERS****20430**(90467-07045-22)  
Black NylonCowl Vent Retaining Pin  
Head Dia: 13mm  
Stem Length: 15mm**Use With Auveco 19727**4 Runner, Pre-Runner,  
Tacoma & Tundra  
1995 - On

UNIT PACKAGE: 15

**19534**(90467-10152)  
Natural NylonCowl Vent Grommet  
Flange Diameter: 18mm  
Stem Length: 16mm  
Fits Into 9mm Hole**Use With Auveco 19535**Lexus ES300, Toyota Camry  
& Tercel  
1995-On

UNIT PACKAGE: 10

**19535**(90467-07126)  
Black NylonCowl Vent Pin Retainer  
Head Diameter: 16mm  
Stem Length: 17mm**Use With Auveco 19534**Lexus ES300, Toyota Camry  
& Tercel  
1995 - On

UNIT PACKAGE: 10

**19583**(90950-01911)  
Black NylonRocker Panel Retainer  
Diameter: 25mm  
Solara  
1998-On

UNIT PACKAGE: 10

**19014**(90467-10123)  
Natural NylonTrim Panel Retainer  
Head Size: 11mm x 12mm  
Stem Length: 16mm  
Fits Into 8mm Hole  
Celica 1993-On

UNIT PACKAGE: 10

**19686**(90467-05045-22)  
Black NylonWeatherstrip Retainer  
Head Diameter: 12mm  
Stem Diameter: 5mm Sq.  
Stem Length: 6mm  
Solara 1998-On

UNIT PACKAGE: 25

**19312**(90467-05096-22)  
Black NylonLuggage Compartment  
Trim Panel Retainer  
Head Diameter: 16mm  
Stem Diameter: 5mm  
Stem Length: 13mm  
Tercel & Paseo  
1994-On

UNIT PACKAGE: 25

**19643**(90467-06175)  
Black NylonLuggage Compartment  
Retainer  
Head Diameter: 16mm  
Stem Diameter: 6mm  
Stem Length: 16mm  
Solara  
1998-On

UNIT PACKAGE: 15

**19121**(90467-08104)  
Gray NylonRoof Headliner Retainer  
Head Diameter: 20mm  
Stem Diameter: 8mm  
Stem Length: 20mm  
MR2  
1990-On

UNIT PACKAGE: 15

**20184**(90467-08186)  
Black NylonLuggage Compartment  
Trim Retainer  
Head Diameter: 16mm  
Stem Diameter: 8mm  
Stem Length: 16mm  
Camry  
1999 - On

UNIT PACKAGE: 25

**20438**(90467-06070-B1)  
Gray NylonHeadliner Retainer  
Head Dia.: 25mm  
Stem Dia.: 6mm  
Stem Length: 17mm  
RAV 4  
1995 - On

UNIT PACKAGE: 25

**20305**(90467-07080-B2)  
Gray NylonTrim Panel Retainer  
Head Diameter: 25mm  
Stem Diameter: 7mm  
Stem Length: 20mm  
Tundra Truck  
1999 - On

UNIT PACKAGE: 15

# TOYOTA CLIPS & FASTENERS

**Sec. 22**



**18297**

(Toyota: 90467-08004,  
90467-08011; GM:  
94842841, 94849113)  
Black Nylon

Hood Seal Retaining Clip  
Head Diameter: 13mm  
Stem Length: 11mm  
Fits Into 5mm Hole  
Lexus, Toyota, Geo Prizm & Nova  
1985-On

UNIT PACKAGE: 50



**18841**

(90467-07131)  
Natural Nylon

Retainer  
Head Diameter: 12mm  
Stem Length: 9mm  
Fits Into 6mm Hole  
Side Member Retainer  
Camry  
1991-On

UNIT PACKAGE: 25



**16779**

(Honda: 74842-659-0030; Toyota:  
90467-12078)  
Black Nylon

Retaining Clip  
Head Dia: 18mm  
Stem Length: 15mm  
Panel Thickness: 6mm  
Fits Into 8mm Hole

UNIT PACKAGE: 25



**14737**

(Toyota: 90467-07050;  
Nissan: 01553-00172)  
Black Nylon

Retaining Clip  
Head Diameter: 13mm  
Stem Length: 15mm  
Fits Into 5mm Hole  
Panel Thickness: 3mm

UNIT PACKAGE: 25



**19122**

(90467-08122)  
Natural Nylon

Headliner Retaining Clip  
Head Diameter: 15mm  
Stem Diameter: 8mm  
Stem Length: 12mm  
Tacoma & T100  
1992-On

UNIT PACKAGE: 15



**19842**

(75867-30110)  
Black Nylon

Rocker Panel Clip  
Head Diameter: 18mm  
Stem Length: 22mm  
Fits Into 9mm Hole  
Corolla  
1997 - On

UNIT PACKAGE: 15



**14736**

(90467-06161-01)  
Black Nylon

Retaining Clip  
Head Diameter: 14mm  
Stem Length: 10mm  
Fits Into 5mm Hole  
Panel Thickness: 3mm

UNIT PACKAGE: 25



**19124**

(90467-07096)  
Black Nylon

Side Trim Panel  
Retaining Clip  
Head Diameter: 16mm  
Stem Length: 10mm  
Fits Into 6mm Hole  
4WD Truck 1989-On

UNIT PACKAGE: 10



**19113**

(90467-08124)  
Black Nylon

Hood Insulation Retainer  
Head Diameter: 25mm  
Stem Diameter: 8mm  
Stem Length: 12mm  
Supra 1993-On  
Lexus 1994-89

UNIT PACKAGE: 15



**16781**

(Honda: 90670-692-0030;  
Toyota: 90467-09065)  
Black Nylon

Retaining Clip  
Head Dia: 15mm  
Stem Length: 20mm  
Panel Thickness: 11mm  
Fits Into 7mm Hole

UNIT PACKAGE: 25



**16777**

(Mazda: B001-68-302-00;  
Toyota: 90950-01248)  
Black Nylon

Retaining Clip  
Head Dia: 15mm  
Stem Length: 15mm  
Panel Thickness: 2mm  
Fits Into 8mm Hole

UNIT PACKAGE: 25



**19729**

(90467-09050)  
Black Nylon

Hood Insulation Retainer  
Head Diameter: 25mm  
Stem Length: 10mm  
Fits Into 7mm Hole  
Lexus, Camry & Solara  
1998-On

UNIT PACKAGE: 15



**18878**  
(90467-08081)  
Black Nylon

Hood Insulation Retainer  
Head Diameter: 30mm  
Stem Length: 16mm  
Fits Into 6mm Hole  
Celica 1993-89

UNIT PACKAGE: 15

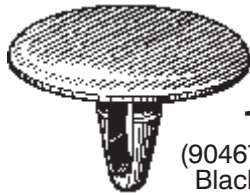

**14738**  
(90467-09008)  
Black Nylon

Retaining Clip  
Head Diameter: 30mm  
Stem Length: 17mm  
Fits Into 7mm Hole  
Panel Thickness: 6mm

UNIT PACKAGE: 25



**20443**  
(67867-0C010)  
Black Nylon

Weatherstrip Retainer  
Head Size: 5mm x 15mm  
Stem Length: 10mm  
Fits Into 6mm Hole  
Tundra  
1999 - On

UNIT PACKAGE: 25



**19112**  
(90467-09004)  
Black Nylon

Hood Insulation Retainer  
Head Diameter: 30mm  
Stem Diameter: 8mm  
Stem Length: 16mm  
Tacoma 1995-On

UNIT PACKAGE: 15



**19123**  
(90467-10107)  
Black Nylon

Fender Apron Seal Clip  
Head Diameter: 17mm  
2WD & 4WD Truck  
1988-On

UNIT PACKAGE: 10



**16778**  
(Mazda: 9927-40-822;  
Toyota: 62581-14020)  
Natural Nylon

Trim Panel Retainer  
Top Head Dia: 14mm  
Bottom Head Dia: 18.5mm  
Stem Dia: 11.5mm  
Stem Length: 14mm  
Overall Length: 20mm

UNIT PACKAGE: 25



**19749**  
(67867-12150)  
White Nylon

Weatherstrip Retainer  
Head Size: 5mm x 15mm  
Stem Length: 10mm  
Fits Into 6mm Hole  
Avalon  
1995 - On

UNIT PACKAGE: 15



**18842**  
(90467-09006)  
Black Nylon

Hood Insulation Retainer  
Head Diameter: 30mm  
Stem Length: 17mm  
Fits Into 7mm Hole  
Avalon, Camry, Lexus  
1988-On

UNIT PACKAGE: 15



**18692**  
(Mazda: G031-58-762;  
Toyota: 67868-89101,  
67867-28030,  
67867-89103)  
Natural Nylon

Weatherstrip Retainer  
Head Size: 5mm x 15mm  
Stem Length: 10mm  
Fits Into 5mm Hole  
4-Runner  
1989-83  
Mazda 1996-On

UNIT PACKAGE: 50



**20576**  
(GM: 88969790;  
Toyota: 75867-21010)  
Yellow Nylon

Fender Flare Retainer  
Top Head Size: 10mm x 13mm  
Bottom Head Size: 14mm x 18mm  
Stem Diameter: 8.5mm x 8.5mm  
Stem Length: 9mm  
Overall Length: 13.5mm  
Pontiac Vibe &  
Toyota Echo  
2002 - On

UNIT PACKAGE: 25

# TOYOTA CLIPS & FASTENERS

**Sec. 22**



**18861**  
(90467-10162)  
White Nylon

Scuff Plate Retainer  
Top Head Dia: 13mm  
Bottom Head Dia: 18mm  
Stem Dia: 8.5mm x 8.5mm  
Stem Length: 12mm  
Overall Length: 17mm  
Celica  
1993-On

UNIT PACKAGE: 15



**19719**  
(67921-32010)  
White Nylon

Scuff Plate Retainer  
Top Head Diameter: 13mm  
Bottom Head Diameter: 18mm  
Stem Dia: 10mm  
Stem Length: 11mm  
Overall Length: 17.5mm  
Avalon, Camry & Corolla  
1997 - On

UNIT PACKAGE: 15



**18875**  
(67771-16170)  
White Nylon

Door Trim  
Panel Retainer  
Top Head Dia: 13mm  
Bottom Head Dia: 18mm  
Stem Dia: 11mm  
Stem Length: 15mm  
Overall Length: 19.5mm  
Tercel 1991-On

UNIT PACKAGE: 25



**20473**  
(67771-12070)  
White Nylon

Door Panel &  
Rocker Moulding Retainer  
With Sealer  
Top Head Diameter: 13mm  
Bottom Head Diameter: 18mm  
Stem Diameter: 11mm  
Stem Length :14mm  
Overall Length: 20mm  
Lexus SC300/400  
Toyota Avalon & Corolla  
1992 - On

UNIT PACKAGE: 15



**20558**  
(62217-13010)  
White Nylon

Garnish Moulding Retainer  
Top Head Diameter: 13mm  
Middle Head Diameter: 16mm  
Bottom Head Diameter: 15mm  
Stem Diameter: 9mm x 9mm  
Stem Length: 11mm  
Overall Length: 17mm  
Lexus and Toyota Corolla,  
Matrix & 4 Runner  
2003 - On

UNIT PACKAGE: 25



**19109**  
(67771-30070)  
Natural Nylon

Door Trim Panel  
& Garnish Retainer  
Top Head Dia: 13mm  
Middle Head Dia: 16mm  
Bottom Head Dia: 15mm  
Stem Diameter: 9.5mm  
Stem Length: 11mm  
Overall Length: 18mm  
Corolla Wagon, Tercel,  
T-100 & Tacoma 2WD  
1992-On

UNIT PACKAGE: 25



**20559**  
(GM: 88970345;  
Toyota: 90467-10167)  
Blue Nylon

Garnish Moulding Retainer  
Top Head Diameter: 13mm  
Middle Head Diameter: 16mm  
Bottom Head Diameter: 18mm  
Stem Diameter: 9mm x 9mm  
Stem Length: 11mm  
Overall Length: 18mm  
Pontiac Vibe, Lexus and Toyota  
2000 - On

UNIT PACKAGE: 25

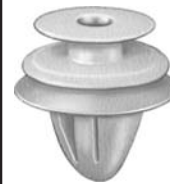

**19203**  
(67771-89104)  
Natural Nylon

Quarter Board  
Inside Trim Panel Retainer  
Top Head Dia: 13mm  
Middle Head Dia: 16mm  
Bottom Head Dia: 18mm  
Stem Diameter: 11mm  
Stem Length: 11mm  
Overall Length: 18.5mm  
Truck 2WD  
1997-91

UNIT PACKAGE: 15



**20439**  
(90467-09158)  
White Nylon

Garnish Retainer  
Top Head Dia.: 13mm  
Middle Head Dia.: 16mm  
Bottom Head Dia.: 18mm  
Stem Dia.: 11mm  
Stem Length: 12mm  
Overall Length: 19mm  
Camry & RAV 4  
1999 - 95

UNIT PACKAGE: 25



**14728**  
(67771-22020)  
Natural & Yellow Nylon

Door Panel Retainer  
Top Head Diameter: 12.5mm  
Middle Head Diameter: 16mm  
Bottom Head Diameter: 13mm  
Stem Diameter: 8.5mm  
Stem Length: 11mm  
Overall Length: 20mm

UNIT PACKAGE: 25



**19015**  
(90080-46199)  
Natural Nylon

Trim Panel Retainer  
Top Head Dia: 13mm  
Middle Head Dia: 16mm  
Bottom Head Dia: 18mm  
Stem Diameter: 10mm  
Stem Length: 12mm  
Overall Length: 20mm  
Tacoma 1995-On

UNIT PACKAGE: 25



**20575**  
(67771-12080)

Yellow & White Nylon

Door Panel & Rocker  
Moulding Retainer  
Top Head Dia: 13mm  
Middle Head Dia: 16mm  
Bottom Head Dia: 18mm  
Stem Diameter: 10mm  
Stem Length: 13mm  
Overall Length: 20mm  
Toyota & Lexus  
1998 - On

UNIT PACKAGE: 15



**20437**  
(90467-09206)  
White Nylon

Trim Panel Retainer  
Top Head Dia: 13mm  
Middle Head Dia: 16mm  
Bottom Head Dia: 18mm  
Stem Dia: 8.5mm x 8.5mm  
Stem Length: 15mm  
Overall Length: 20mm  
RAV 4 & Tundra  
2000 - On

UNIT PACKAGE: 15



**18844**  
(67771-06010,  
67771-32090)  
White Nylon

Trim Panel Retainer  
Top Head Diameter: 13mm  
Middle Head Diameter: 16mm  
Bottom Head Diameter: 18mm  
Stem Diameter: 10mm  
Stem Length: 13mm  
Overall Length: 20mm  
Cowl Side & Garnish  
Center Pillar Retainer  
Camry  
1991-On

UNIT PACKAGE: 10



**18876**  
(Toyota: 90467-10161;  
GM: 94858299)  
White Nylon

Trim Board Retainer  
Top Head Dia: 13mm  
Middle Head Dia: 16mm  
Bottom Head Dia: 18mm  
Stem Dia: 9mm x 9mm  
Stem Length: 14mm  
Overall Length: 20mm  
Toyota Sienna, Solara & Tercel  
1990-On  
Geo Prizm & Pontiac Vibe  
1998-On

UNIT PACKAGE: 25



**20633**  
(90467-10188)  
Turquoise Nylon

Trim Panel Retainer  
Top Head Diameter: 13mm  
Middle Head Diameter: 16mm  
Bottom Head Diameter: 18mm  
Stem Diameter: 8.5mm x 9mm  
Stem Length: 14mm  
Overall Length: 20mm  
Sienna  
2004 - On

UNIT PACKAGE: 25



**19257**  
(GM: 30006620;  
Toyota: 67771-12050)  
Maroon Nylon

Front & Rear Door  
Trim Board Retainer  
Top Head Diameter: 13mm  
Middle Head Diameter: 16mm  
Bottom Head Diameter: 18mm  
Stem Diameter: 9.5mm  
Stem Length: 14mm  
Overall Length: 20.5mm  
Chevrolet Geo, Metro & Tracker  
1989 - On  
Lexus and Celica,  
Corolla & Previa  
1990-On

UNIT PACKAGE: 15



**18950**  
(90467-10168)  
Black & White Nylon

Garnish Retainer  
Top Head Dia: 13mm  
Middle Head Dia: 16mm  
Bottom Head Dia: 18mm  
Stem Diameter: 10mm  
Stem Length: 13mm  
Overall Length: 20mm  
Avalon & Camry 1991-On

UNIT PACKAGE: 5



**19910**  
(90467-08179)  
Yellow Nylon

Garnish Retainer  
Top Head Diameter: 13mm  
Middle Head Diameter: 16mm  
Bottom Head Diameter: 18mm  
Stem Diameter: 9mm x 9mm  
Stem Length: 14mm  
Overall Length: 20mm  
Tundra  
1999 - On

UNIT PACKAGE: 25

# TOYOTA CLIPS & FASTENERS

**Sec. 22**



**14144**  
(67771-01010)  
Black Nylon

Trim Panel Retainer  
Top Head Diameter: 13mm  
Middle Head Diameter: 15.5mm  
Bottom Head Diameter: 18mm  
Stem Diameter: 9.5mm  
Stem Length: 14mm  
Overall Length: 20.5mm

UNIT PACKAGE: 25



**15709**  
(67771-02030)  
Natural Nylon

Door Trim Retainer  
Top Head Dia: 13mm  
Middle Head Dia: 16mm  
Bottom Head Dia: 17.5  
Stem Diameter: 9.5mm  
Stem Length: 13mm  
Overall Length: 21mm  
Corolla 1990 - On

UNIT PACKAGE: 50



**19108**  
(67771-16080)  
Natural Nylon

Door Trim Panel  
& Back Panel  
Upper Garnish Retainer  
Top Head Dia: 13mm  
Middle Head Dia: 16mm  
Bottom Head Dia: 18mm  
Stem Diameter: 9.5mm  
Stem Length: 14mm  
Overall Length: 21mm  
Truck 1988-On

UNIT PACKAGE: 10



**14269**  
(Toyota: 67771-01010,  
67771-12010;  
Isuzu: 8942264920;  
Mazda: 9927-40-825)  
White Nylon

Door Panel Retainer  
Top Head Diameter: 13mm  
Middle Head Diameter: 15.5mm  
Bottom Head Diameter: 18mm  
Stem Diameter: 9.5mm  
Stem Length: 14mm  
Overall Length: 20.5

UNIT PACKAGE: 25



**19898**  
(67771-02030)  
Yellow Nylon

Trim Panel Retainer  
Top Head Dia.: 13mm  
Middle Head Dia.: 16mm  
Bottom Head Dia.: 18mm  
Stem Diameter: 9.5mm  
Stem Length: 13mm  
Overall Length: 21mm  
Corolla  
1990 - On

UNIT PACKAGE: 50



**19256**  
(67771-20110)  
Dark Gray Nylon

Door Trim Panel Retainer  
Top Head Dia: 13mm  
Middle Head Dia: 16mm  
Bottom Head Dia: 18mm  
Stem Diameter: 9.5mm  
Stem Length: 14mm  
Overall Length: 21mm  
T100 & RAV 4  
1992 - On

UNIT PACKAGE: 15



**14270**  
(67771-22010)  
Blue & Natural Nylon

Door Panel Retainer  
Top Head Diameter: 13mm  
Middle Head Diameter: 15.5mm  
Bottom Head Diameter: 18mm  
Stem Diameter: 9.5mm  
Stem Length: 14mm  
Overall Length: 20.5mm

UNIT PACKAGE: 25



**15707**  
(67771-03030)  
Gray Nylon

Door Trim Retainer  
Top Head Dia: 13mm  
Middle Head Dia: 16mm  
Bottom Head: 17.5mm  
Stem Length: 14mm  
Stem Diameter: 10mm  
Overall Length: 21mm  
Camry 1988 - On

UNIT PACKAGE: 50



**20174**  
(67771-28020)  
Maroon Nylon

Trim Panel Retainer  
Top Head Diameter: 13mm  
Middle Head Diameter: 16mm  
Bottom Head Diameter: 18mm  
Stem Diameter: 9.5mm  
Stem Length: 14mm  
Overall Length: 21mm  
Tundra  
1999 - On

UNIT PACKAGE: 15



**18874**  
(67771-16120)  
Gray Nylon

Front & Rear Door  
Trim Panel Retainer  
Top Head Dia: 13mm  
Middle Head Dia: 16mm  
Bottom Head Dia: 18mm  
Stem Diameter: 9.5mm  
Stem Length: 15mm  
Overall Length: 21mm  
Tercel 1994 - On

UNIT PACKAGE: 15



**19129**  
(67771-30090)  
Yellow Nylon

Door Trim Panel & Back Panel  
Lower Garnish Retainer  
Top Head Dia: 13mm  
Middle Head Dia: 16mm  
Bottom Head Dia: 18mm  
Stem Diameter: 9.5mm  
Stem Length: 17mm  
Overall Length: 23mm  
Land Cruiser & 2WD Truck  
1991 - On

UNIT PACKAGE: 15



**20196**  
(90467-06133-CO)  
Black Nylon

Rocker Panel  
Push-Type Retainer  
Head Diameter: 14mm  
Stem Length: 8mm  
Fits Into 6mm Hole  
4-Runner  
1998 - On

UNIT PACKAGE: 15



**19016**  
(67771-12040)  
Dark Gray Nylon

Door Trim Panel Retainer  
Top Head Dia: 13mm  
Middle Head Dia: 16mm  
Bottom Head Dia: 18mm  
Stem Diameter: 21mm  
Stem Length: 15mm  
Overall Length: 21mm  
Cressida  
1992 - 88

UNIT PACKAGE: 15



**19728**  
(90467-10146)  
Black Nylon

Cowl Panel Retainer  
Head Size: 8mm x 17mm  
Stem Length: 14mm  
Fits Into 7mm Hole  
Sienna Van  
1997 - On

UNIT PACKAGE: 25



**14260**  
(Toyota: 90467-06017;  
Mazda: 9926-50-625;  
GM: 20426301)  
Black Nylon

Push-Type Retainer  
Head Diameter: 15mm  
Stem Length: 12mm  
Fits Into 7mm Hole

UNIT PACKAGE: 15



**17206**  
(90467-09145)  
Black Nylon

Bumper Cover  
Push-Type Retainer  
Head Diameter: 15mm  
Stem Length: 12mm  
Fits Into 9mm Hole  
Camry  
1992-On

UNIT PACKAGE: 15



**19210**  
(67771-04040)  
Natural Nylon

Front Door  
Trim Panel Retainer  
Top Head Dia: 13mm  
Middle Head Dia: 16mm  
Bottom Head Dia: 18mm  
Stem Diameter: 10mm  
Stem Length: 14mm  
Overall Length: 22mm  
Tacoma 1995 -On

UNIT PACKAGE: 50



**19720**  
(90467-06138)  
Black & White Nylon

Hood To Cowl Seal Retainer  
Head Size: 8mm x 17mm  
Stem Length: 16mm  
Fits Into 7mm Hole  
Avalon & Camry  
1994 - On

UNIT PACKAGE: 10



**19552**  
(90467-07146)  
Black Nylon

Cowl Panel & Luggage  
Compartment Retainer  
Head Dia.: 16mm  
Stem Length: 9mm  
Fits Into 7mm Hole  
Avalon, Camry, Celica & Solara  
1993 - On

UNIT PACKAGE: 15





**20335**  
(53879-60010)  
Black Nylon

Fender Liner  
Push-Type Retainer  
Head Diameter: 18mm  
Stem Length: 7mm  
Fits Into 7mm Hole  
RAV 4  
2000 - On  
UNIT PACKAGE: 15



**19490**  
(90467-06150)  
Black Nylon

Back Garnish Trim Panel  
Push-Type Retainer  
Head Diameter: 18mm  
Stem Length: 8mm  
Fits Into 6mm Hole  
Tacoma  
1995 - On  
UNIT PACKAGE: 10



**19908**  
(90467-07121)  
Black Nylon

Door Trim Panel  
Push-Type Retainer  
Head Diameter: 20mm  
Stem Length: 8mm  
Fits Into 7mm Hole  
RAV4  
1997 - On  
UNIT PACKAGE: 10



**19907**  
(90467-07121-B2)  
Gray Nylon

Door Trim Panel  
Push-Type Retainer  
Head Diameter: 20mm  
Stem Length: 8mm  
Fits Into 7mm Hole  
RAV4  
1997 - On  
UNIT PACKAGE: 10



**20577**  
(GM: 88970494;  
Toyota: 90467-07168)  
Black Nylon

Rocker Panel & Garnish Moulding  
Push-Type Retainer  
Head Diameter: 20mm  
Stem Length: 8mm  
Fits Into 7mm Hole  
Pontiac Vibe 2003 - On  
Lexus & Toyota  
2000 - On  
UNIT PACKAGE: 15



**19128**  
(90467-07044)  
Black Nylon

Quarter Panel  
Wheel Opening Moulding  
Push-Type Retainer  
Head Diameter: 20mm  
Stem Length: 9mm  
Fits Into 7mm Hole  
T-100  
1992-On  
UNIT PACKAGE: 10



**19140**  
(Acura:  
90505-SL0-003;  
GM: 94852368;  
Mitsubishi:  
MB888869; Toyota:  
90467-08155)  
Black Nylon

Push-Type Retainer  
Head Dia: 20mm  
Stem Length: 21mm  
Fits Into 8mm Hole  
Acura, Dodge Avenger, Eagle Talon,  
Geo Prizm, Mitsubishi Eclipse  
& Galant and Toyota  
1993-On  
UNIT PACKAGE: 5



**19739**  
(90467-09127)  
Black Nylon

Bumper Cover  
Push-Type Retainer  
Head Diameter: 20mm  
Stem Length: 26mm  
Fits Into 9mm Hole  
Avalon, Camry,  
Corolla & Solara  
1998 - On  
UNIT PACKAGE: 10



**19219**  
(90467-09096)  
Black Nylon

Front Bumper  
Push-Type Retainer  
Head Diameter: 15mm  
Stem Length: 27mm  
Fits Into 9mm Hole  
Lexus LS400 1993-On  
Celica & Supra 1989-On  
UNIT PACKAGE: 10



**17162**  
(GM: 96057846;  
Toyota: 90467-07041)  
Black Nylon

Push-Type Retainer  
Head Diameter: 15mm  
Stem Length: 13mm  
Fits Into 6.3mm Hole  
Geo Metro & Tracker  
And Toyota  
1989 - On  
UNIT PACKAGE: 10



**16784**

(Nissan: 80999-05N07;  
Toyota: 90467-07043)  
Black Nylon

Push-Type Retainer  
Head Dia: 18mm  
Stem Length: 11mm  
(Not Including The Pin)  
Fits Into 7mm Hole  
UNIT PACKAGE: 25



**18888**

(90467-07166)  
Black Nylon

Front Fender Liner  
Push-Type Retainer  
Head Diameter: 20mm  
Stem Length: 8mm  
Fits Into 7mm Hole  
Tercel 1994-On  
UNIT PACKAGE: 15



**14732**

(53455-14020)  
Nylon

Hood Prop  
Rod Clip  
Holds 8mm Dia. Rod  
Snaps Into 14mm Hole  
UNIT PACKAGE: 15



**19013**

(90467-07059-22)  
Black Nylon

Rear Door Trim &  
Luggage Compartment Door  
Push-Type Retainer  
Head Diameter: 15mm  
Stem Length: 10mm  
Fits Into 7mm Hole  
Camry & Celica  
1990-On  
UNIT PACKAGE: 15



**18873**

(52161-16010,  
52161-02020)  
Black Nylon

Rear Bumper Cover  
Push-Type Retainer  
Head Diameter: 18mm  
Stem Length: 28mm  
Fits Into 9mm Hole  
Tercel 1988-On  
UNIT PACKAGE: 6



**20441**

(53455-12060)  
Black Nylon

Hood Prop Rod Clip  
Holds 8mm Dia. Rod  
Fits Into 10mm Square Hole  
RAV 4  
1999 - 95  
UNIT PACKAGE: 10



**19416**

(Toyota: 90467-09139)  
Black Nylon

Bumper Cover &  
Wheel Housing  
Push-Type Retainer  
Head Diameter: 18mm  
Stem Length: 15mm  
Fits Into 9mm Hole  
Honda, Mazda 626 &  
Toyota Corolla  
1992-On  
UNIT PACKAGE: 15



**19488**

(67772-16020)  
Black Rubber

Front Door  
Trim Retainer Cap  
Fits Into 9mm Hole  
T100 Truck  
1992 - On  
UNIT PACKAGE: 10

Do You Want Your  
Customers To Know You  
Use The Best Body  
Hardware & Specialty  
Fasteners Available?  
Promotional Products And  
Apparel Bearing  
The  Logo Promote  
Your Identity As A  
Professional.



**16780**

(Nissan: 99604-H1400;  
Toyota: 58788-13010)

Hood Prop Rod Clip  
Holds 11mm Dia. Rod  
Fits Into 10mm x 12mm Hole

UNIT PACKAGE: 10



**17631**

(90959-01136)  
Nylon

Hood Prop Rod Clip  
Holds 6mm & 7mm Rods  
Toyota

UNIT PACKAGE: 25



**17611**

(53452-90351)  
Nylon

Hood Prop Rod Clip  
Holds 6mm & 7mm Rods  
Toyota

UNIT PACKAGE: 10



**19529**

(53455-33010,  
53455-33011)  
Natural Nylon

Hood Prop Rod Clip  
Holds 9mm Rod  
Fits Into 10mm Square Hole  
Camry  
1996 - On

UNIT PACKAGE: 15



**20469**

(69293-12030)  
Natural Nylon

Door Lock Rod Clip  
Rod Size: 5mm  
Right (Passenger) Side  
Lexus ES 300 2001 - 97  
Toyota Camry, Celica, Corolla,  
Echo, Highlander, MR2,  
RAV4, Tundra and 4-Runner  
1994 - On

UNIT PACKAGE: 10



**20470**

(69293-12040)  
Yellow Nylon

Door Lock Rod Clip  
Rod Size: 5mm  
Left (Driver) Side  
Lexus ES 300 2001 - 97  
Toyota Camry, Celica, Corolla,  
Echo, Highlander, MR2, RAV 4,  
Tundra and 4-Runner  
1994 - On

UNIT PACKAGE: 10



**20534**

(69293-12050)  
Natural Nylon

Door Lock Rod Clip  
Rod Size: 5mm  
Fits Into 8.5mm Hole  
Right (Passenger) Side  
Lexus ES250, 300 & RX300  
and Toyota Tacoma  
1990 - On

UNIT PACKAGE: 10



**20535**

(69293-12060)  
Yellow Nylon

Door Lock Rod Clip  
Rod Size: 5mm  
Fits Into 8.5mm Hole  
Left (Driver) Side  
Lexus ES250, 300 & RX300  
And Toyota Tacoma  
1990 - On

UNIT PACKAGE: 10



**14735**

(Toyota: 90463-10338;  
Mitsubishi: AA-000000)  
Nylon

Cable Strap  
Length: 80mm (3-1/8")  
Max. Bundle  
Diameter: 12mm  
Fits Into 7mm Hole

UNIT PACKAGE: 25

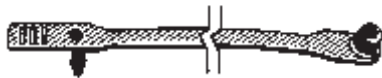

**14284**

(Toyota: 90463-10337;  
Honda: 90669-671-0000;  
90669-671-0030)  
Nylon

Cable Strap  
Length: 110mm (5-5/16")  
Max. Bundle Diameter: 23mm  
Fits Into 6mm Hole  
UNIT PACKAGE: 15



**16306**

(90183-03001)

Front Bumper  
Cushion Clip  
Toyota 1982-On

UNIT PACKAGE: 25



**14276**

(53879-22010)

Black Nylon

Nylon "U" Nut  
Fender/Wheel  
Housing Applications

#14(1/4") Screw Size

20mm Wide

29mm Long

Panel Range: Up To 1mm

Center Of Hole To Edge: 15mm

UNIT PACKAGE: 15



**14279**

(Toyota: 90463-10024;  
Honda: 90672-692-0030)  
Nylon

Cable Strap  
Length: 170mm (6-11/16")  
Max. Bundle Diameter: 40mm  
Fits Into 6mm Hole  
UNIT PACKAGE: 25



**16671**

(90468-04030)

Bumper Strip  
Retainer  
Toyota 1984-On

UNIT PACKAGE: 25



**14750**

(Toyota: 53879-14010-A,  
53879-14020,  
53879-22030; GM: 94841226;  
Mazda: LA01-56-135)  
Black Nylon

Nylon "U" Nut  
Fender/Wheel  
Housing Applications

#10 Screw Size

20mm Wide

31mm Long

Panel Range: Up to 1mm

Center of Hole To Edge: 11mm

Toyota, Geo Prizm &  
Nova And Mazda

UNIT PACKAGE: 15



**13225**

Plated

"U" Type Nut

4.2mm (#8) Screw Size

11mm Wide

16.5mm Long

Panel Range: .5mm-2.5mm

Center of Hole To Edge: 8mm

UNIT PACKAGE: 50



**20380**

Not Supplied By O.E.M.  
Black Nylon

Cable Strap  
Length: 200mm (8")  
Max. Bundle Dia: 44mm (1-3/4")  
Fits Into 6.3mm (1/4") Hole  
Import Cars  
UNIT PACKAGE: 25

**19669**  
Same As 14750 Except For Packing

UNIT PACKAGE: 25

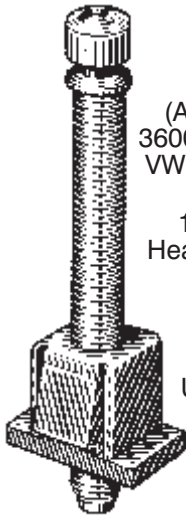

**15666**  
(AMC: 36000148,  
36001966, 56001419;  
VW: 176-941-1117A)

1/4"-28 x 2-1/4"  
Headlight Adjusting  
Screw and  
Nut Assembly  
AMC & VW

UNIT PKG: 10



**19136**

(1HO-853-733B)  
Nylon

Windshield Reveal  
Moulding Clip  
VW Golf & Jetta  
1999-93

UNIT PACKAGE: 15



**10322**

(131-853-585C)  
Nylon

Body Side Moulding Clip  
VW

UNIT PACKAGE: 50



**13175**

(171-853-575A)  
Nylon

Moulding Clip  
VW

UNIT PACKAGE: 50



**13189**

(803-853-139A)  
Nylon

Moulding Clip  
Audi

UNIT PACKAGE: 50



**13174**

(803-853-139C)  
Red Nylon

Moulding Clip  
VW

UNIT PACKAGE: 25



**13229**

(113-853-585C)  
Nylon

Moulding Clip  
w/ Sealer  
VW

UNIT PACKAGE: 50



**12635**

(801-853-577)  
Nylon

Moulding Clip  
VW

UNIT PACKAGE: 25



**20249**

(321-867-299B)  
Natural Nylon

Door Panel Trim Clip  
Eurovan, Golf, Jetta,  
Quantum & Scirocco  
1982 - On

UNIT PACKAGE: 15



**13173**

(VW: N14389.3;  
Volvo: 3104-426)  
Metal

Door Panel Clip  
Use With 13206

UNIT PACKAGE: 50



**13176**

(113-853-585B)  
Metal

Moulding Clip

UNIT PACKAGE: 25



**8843**

Nylon

Moulding Fastener  
Fits 1/2" -5/8" Mouldings

UNIT PACKAGE: 50



**14014**

(VW: 175-853-674;  
GM: 20475950)  
Black Nylon

Air Vent Nut

Use With 14013 Screw

UNIT PACKAGE: 50



**14030**

(GM: 3997391;  
VW: 179-813-881)  
Black Nylon

Tail Light Nut  
#8 Screw Size  
GM Astro & Safari  
1985-On  
Volkswagen

UNIT PACKAGE: 25



**20260**

(1J0-853-120)  
Maroon Nylon

Scuff Plate  
Screw Grommet  
Head Size: 14mm x 17mm Oval  
Stem Length: 10mm  
M4.2 (#8) Screw Size  
Golf & Jetta  
1999 - On

UNIT PACKAGE: 15



**12735**

(GM: 1370853;  
Chry: 6029501;  
VW: 179-813-883)  
Nylon

Headlight Bezel Nut  
#6 Screw Size  
GM & VW 1982-On  
UNIT PACKAGE: 50



**13185**

(803-853-213)  
Nylon

Barrel Nut  
For 2mm Stud  
Fits Into 3mm Hole  
UNIT PACKAGE: 50



**13227**

(113-853-615A)  
Nylon

Barrel Nut  
For 3mm Stud  
Fits Into 4mm Hole  
UNIT PACKAGE: 50



**20250**

(357-853-586-D)  
Black Nylon

Moulding Insert  
Head Diameter: 13mm  
Stem Length: 6mm  
Fits Into 9mm Hole  
Eurovan, Golf, Jetta  
& Passat  
1989 - On  
UNIT PACKAGE: 25



**13206**

(113-857-219A)  
Black Vinyl

Door Panel & Trunk Liner Plug  
**Use With 13173**  
VW Beetle & Audi  
UNIT PACKAGE: 50



**13202**

(801-867-299/041)  
Black Nylon

Retaining Clip  
VW & Audi

UNIT PACKAGE: 25



**20251**

(701-853-585)  
White Nylon

Retainer  
Top Head Dia: 12mm  
Bottom Head Dia: 18mm  
Stem Dia: 7mm  
Stem Length: 20mm  
Mouldings, Water Deflector  
In Cowl Panel & Floor Coverings  
Eurovan, Golf, Jetta  
& Passat  
1989 - On

UNIT PACKAGE: 25



**13475**

(Renault:  
8934-201-681;  
VW: 175-867-299)  
White Nylon

Trim Panel Retainer  
Head Dia: 19mm  
Stem Length: 18mm  
Stem Dia: 9mm  
AMC-Renault 1984-On  
VW 1982-On

UNIT PACKAGE: 50



**13179**

(481-867-197)  
Black Nylon

Trim Panel Retainer  
VW  
UNIT PACKAGE: 50



**20252**

(823-867-299)  
Black Nylon

Trim Panel Retainer  
Top Head Dia: 14mm  
Bottom Head Dia: 18mm  
Stem Dia: 9mm  
Stem Length: 14mm  
Corrado, Eurovan, Jetta,  
Rabbit & Vanagon  
1979 - On

UNIT PACKAGE: 25



**20341**

(3B0-868-243)  
Black Nylon

Door Trim Panel Retainer  
Head Diameter: 22mm  
Stem Length: 10mm  
Fits Into 10mm Hole  
Beetle, Golf, Jetta & Passat  
1998 - On

UNIT PACKAGE: 25



**19195**

(161-867-299-01C)  
Black Nylon

Push-Type Retainer  
Head Diameter: 16mm  
Stem Length: 12mm  
Fits Into 8mm Hole  
VW Golf & Jetta  
1997-93

UNIT PACKAGE: 25



**13217**

(N15.422.2)  
Plated

"U" Nut  
4.2mm (#8) Screw Size  
Panel Range: .7mm -1.6mm  
Center Of Hole To Edge: 7mm

UNIT PACKAGE: 25



**13216**  
Zinc

"U" Nut  
4.8mm Screw Size  
Panel Range: .9mm -2mm  
Center Of Hole To Edge: 8mm

UNIT PACKAGE: 25



**13219**  
(Opel: 20-72-151;  
VW: 311-821-161)  
Plated

"J" Nut  
6.5mm Screw Size  
Panel Range: .7mm -1.5mm  
Center Of Hole To Edge: 13mm

UNIT PACKAGE: 50



**13222**  
(BMW: 0712-9-925-730;  
Mercedes: 000-994-50-45;  
Opel: 20-72-175;  
VW: N15.457.1)  
Plated

"U" Nut  
6.5mm Screw Size  
Panel Range: .7mm -1.5mm  
Center Of Hole To Edge: 13mm

UNIT PACKAGE: 50



**12595**  
(GM: 11503752;  
VW: N90100001)  
Phosphate

Free Spinning Washer Nut  
M6-1.0  
16mm Washer O.D.  
10mm Hex

UNIT PACKAGE: 25

**16268**

Same As 12595 Except For Packing

UNIT PACKAGE: 50



**14013**  
(GM: 20475949;  
VW: 175-853-673)  
Black Nylon

Air Vent Screw  
**Use With 14014**

UNIT PACKAGE: 50



**11404**  
(N14-4003)  
Plain Steel

Manifold Stud  
M8-1.25 x 35mm

UNIT PACKAGE: 25



**11403**  
(N14-443-4)  
Plain Steel

Manifold Stud  
M8-1.25 x 38mm

UNIT PACKAGE: 25



**11097**  
(N 18 515 1)  
Plated

Grease Fitting  
6mm-1.00, Straight  
DIN 71412

Ind. Ref. No. 8601

UNIT PACKAGE: 5



**11098**  
(N 18 516 1)  
Plated

Grease Fitting  
8mm-1.00, Straight  
DIN 71412

Ind. Ref. No. 8901

UNIT PACKAGE: 5



**11099**  
(N 18 511 2)  
Plated

Grease Fitting  
8mm-1.00, 90 Degree  
DIN 71412

Ind. Ref. No. 7490

UNIT PACKAGE: 5



**11100**  
(N 18 530 1)  
Plated

Grease Fitting  
10mm-1.00, Straight  
DIN 71412

Ind. Ref. No. 9301

UNIT PACKAGE: 5

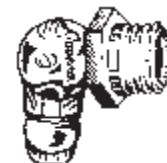

**11101**  
(N 18 510 1)  
Plated

Grease Fitting  
10mm-1.00, 90Degree  
DIN 71412

Ind. Ref. No. 9390

UNIT PACKAGE: 5

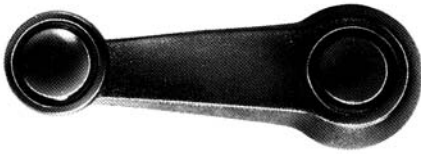

**13031**  
(111-837-581J)  
Black Nylon

Window Crank Handle  
VW Beetle

UNIT PACKAGE: 1



**14194**  
(321-837-581-016)

Window Crank Handle  
VW, Scirocco & Dasher  
1974-On

UNIT PACKAGE: 1

**VOLVO**

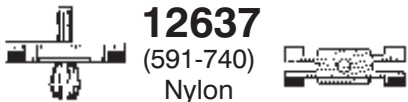

**12637**  
(591-740)  
Nylon

Body Side  
Moulding Clip

UNIT PACKAGE: 50

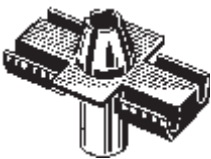

**13195**  
(1201-930)  
Black Nylon

Moulding Clip

UNIT PACKAGE: 10



**17984**  
(3518-274)  
Nylon

Side Moulding Clip  
Volvo  
1992-On

UNIT PACKAGE: 25

**VOLVO (Cont.)**



**20406**  
(1372920-7)  
Black Nylon

Radiator Grille Clip  
9mm Wide, 30mm Long  
850

1999 - 93

UNIT PACKAGE: 15



**20405**  
(9151649-2)  
White Nylon

Rocker Panel Moulding Clip  
Stem Length: 14mm,  
Fits Into 8mm Hole  
850, C70, S70 & V70

1993 - On

UNIT PACKAGE: 10



**13173**

(VW: N14389.3;  
Volvo: 3104-426)  
Metal

Panel Clip

UNIT PACKAGE: 50



**17314**  
(1342-004)

Windshield Upper & Side  
Moulding Clip  
740 & 760 1985-On

UNIT PACKAGE: 15

**VOLVO (Cont.)**



**14211**

(1-255-551)  
Black Nylon

Windshield Clip

UNIT PACKAGE: 25



**14212**

(1-246-926)  
Gray Nylon

Windshield Clip

UNIT PACKAGE: 25



**14210**

(1-255-553)  
White Nylon

Windshield Clip

UNIT PACKAGE: 15



**14209**

(1-246-993)  
Green Nylon

Windshield Clip

UNIT PACKAGE: 15



**13191**

(680-097)  
Black Nylon

Moulding Retainer

UNIT PACKAGE: 50



# VOLVO CLIPS & FASTENERS

**Sec. 22**



**13230**  
(Mercedes 000-990-03-92;  
Volvo 947-098)  
Black Nylon

Push-Type Retainer  
Head Dia. 10mm  
Stem Length: 7mm  
Fits Into 5mm Hole  
UNIT PACKAGE: 50



**19249**  
(3512624-2)  
White Nylon  
Rocker Panel  
Push-Type Retainer  
Head Diameter: 16mm  
Stem Length: 12mm  
Fits Into 8mm Hole  
1993-On  
UNIT PACKAGE: 25



**20407**  
(9133073-8)  
Black Nylon  
Hood Insulation &  
Radiator Seal Push-Type Retainer  
Head Size: 8mm x 25mm  
Stem Length: 10mm  
Fits Into 5mm Hole  
850, 940, 960, S80, S90 & V90  
1991 - On  
UNIT PACKAGE: 25



**19248**  
(1268176-3)  
Black Nylon  
Bumper Cover  
Push-Type Retainer  
Head Diameter: 16mm  
Stem Length: 14mm  
Fits Into 6mm Hole  
740 & 760  
1993-On  
UNIT PACKAGE: 15



**19904**  
(9133417-7)  
Black Nylon  
Rocker Panel  
Push-Type Retainer  
Head Diameter: 16mm  
Stem Length: 14mm  
Fits Into 9mm Hole  
850 Series  
1994 - On  
UNIT PACKAGE: 15



**13220**  
(Mercedes  
000-994-09-45;  
Volvo 946-418;  
Opel 20-72-175)  
Plated  
"U" Type Nut  
6.3mm Screw Size  
Panel Range: .7mm-1.5mm  
Center of Hole To Edge: 13mm  
UNIT PACKAGE: 50

## UNIVERSAL EUROPEAN IMPORT FASTENERS

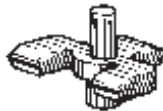

**16131**  
Nylon  
Moulding Clip  
15mm Wide  
20mm Long  
UNIT PACKAGE: 25



**16134**  
Zinc & Yellow  
Thread Cutting Nut  
With Sealer  
For 3mm Stud  
13.5mm O.D.  
8mm Hex  
UNIT PACKAGE: 25



**16146**  
Nylon  
Tubular Nut  
I.D.: 2.5mm  
O.D.: 4.5mm  
Length: 12.5mm  
UNIT PACKAGE: 25



**16132**  
Black Nylon  
Trim Panel Retainer  
Head Dia: 19mm  
Stem Length: 20mm  
Fits Into 8mm Hole  
UNIT PACKAGE: 25



**16143**  
Zinc & Yellow  
Captivated Nut Type  
Tubular Nut  
M4-.7 Thread  
Length: 13mm  
Fits Into 9mm Hole  
UNIT PACKAGE: 10



**16147**  
Nylon  
Tubular Nut  
I.D.: 6.5mm O.D.: 8.5mm  
Flange O.D.: 17mm  
Length: 18mm  
UNIT PACKAGE: 25

**Sec. 23****UNIVERSAL TYPE MOULDING FASTENERS**

(ILLUSTRATIONS ACTUAL SIZE)

**9965**(GM: 1244839,  
3944866)

Moulding Fastener

UNIT PACKAGE: 25**12971**

Same as 9965 Except Packing

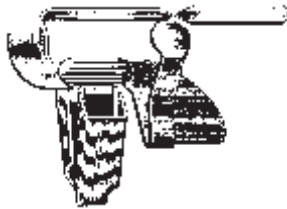
UNIT PACKAGE: 10**2943**(4759145,  
4761842,  
4779348)Front and Rear Fender and Door  
Peak Moulding Fastener  
GMUNIT PACKAGE: 50**12966**

Same As 2943 except packing

UNIT PACKAGE: 15**2744**(Chry: 1624705,  
6010093)Moulding Fastener  
#10-24 x 3/4" Bolt  
Plate Length: 3/4"  
Plate Width: 5/16"UNIT PACKAGE: 50**12959**

Same as 2744 Except for Packing

UNIT PACKAGE: 15**19626**(Ford: 358560;  
Chry: 1560058;  
6010029;  
GM: 568792;  
574355;  
1165051)Moulding Fastener  
#10-24 x 3/4" Bolt  
Plate Length: 1"  
Plate Width: 1/2"**Replaces Auveco 2514**UNIT PACKAGE: 25**19627**

Same as 19626 Except for Packing

UNIT PACKAGE: 15**2818**(GM: 4689929,  
4778814)Moulding Fastener  
#10-24 x 3/4" Bolt  
Plate Length: 3/4"  
Plate Width: 5/16"UNIT PACKAGE: 50**12962**

Same as 2818 Except for Packing

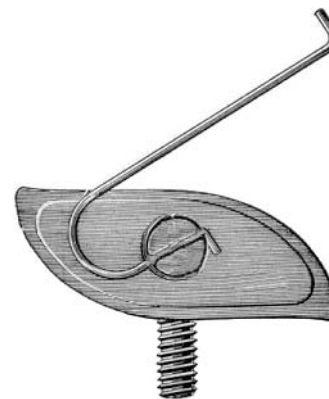
UNIT PACKAGE: 15**20175**(4637277,  
4730773)Moulding Fastener  
#10-24 x 3/4"  
Plate Length: 1-5/8"  
Plate Width: 11/16"**Replaces Auveco 2821**UNIT PACKAGE: 25

# UNIVERSAL TYPE MOULDING FASTENERS

**Sec. 23**

(ILLUSTRATIONS ACTUAL SIZE)



**2789**

(GM: 575411,  
4723818)

Moulding Fastener  
#10-24 x 5/8" Bolt  
Plate Length: 1-5/8"  
Plate Width: 9/16"

UNIT PACKAGE: 50

**12961**

Same as 2789 Except for Packing

UNIT PACKAGE: 15



**2752**

(GM: 3744999;  
Chry: 1758099;  
6000720;  
6010046)

Moulding Fastener  
#10-24 x 3/4" Bolt  
Plate Length: 1-25/32"  
Plate Width: 9/16"

UNIT PACKAGE: 50

**12960**

Same As 2752 Except Packaging

UNIT PACKAGE: 15



**19378**

Zinc

Universal Moulding Fastener  
#10 - 24 x 3/4" Bolt  
2-1/2" x 3/4" Plate  
Break Off Plate At 1/16" Perforations  
To Fit Moulding  
**Replaces Auveco 2356**  
Use With Auveco Hex Nut 730

UNIT PACKAGE: 25



**2619**

(Chry: 6000705,  
6013029;  
GM: 3722635)

Moulding Fastener  
#10-24 x 3/4" Bolt  
Plate Length: 1-11/32"  
Plate Width: 1/2"

UNIT PACKAGE: 50

**12958**

Same as Above Except for Packing

UNIT PACKAGE: 15



**19807**

(GM: 4676189)

Moulding Fastener  
#10-24 x 3/4" Bolt  
Plate Length: 2-17/32"  
Plate Width: 11/16"  
**Replaces Auveco 2820**

UNIT PACKAGE: 15



**8581**

Nylon

Moulding Fastener  
Plate Length: 3"  
Plate Width: 3/4"  
Break Off Plate  
At 5/32" Perforations  
To Fit Moulding

UNIT PACKAGE: 10

**Sec. 23**

**UNIVERSAL TYPE MOULDING FASTENERS**

(ILLUSTRATIONS ACTUAL SIZE)



**5889**

Universal Moulding  
Fastener  
For 5/16"-1/2" Moulding  
Fits Into 3/8" Hole

UNIT PACKAGE: 50



**8448**

(GM: 4879481)  
Nylon

Front & Rear Door Moulding  
Fastener  
For 3/4" To 1" Moulding

UNIT PACKAGE: 50

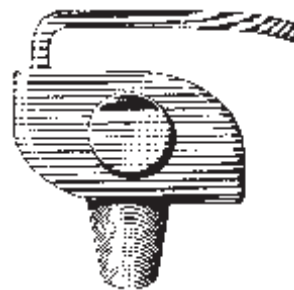

**8399**

(GM: 4883164)  
Nylon

Rear Fender Lower Moulding  
Fastener  
For 7/8" To 1-1/4" Mouldings

UNIT PACKAGE: 25



**8843**

Nylon

Moulding Fastener  
For 1/2"-5/8" Mouldings

UNIT PACKAGE: 50

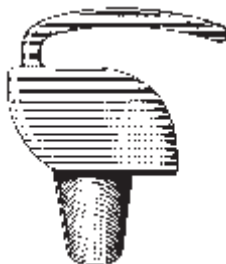

**8398**

(GM: 4853108)  
Nylon

Front & Rear Door and  
Quarter Panel Moulding Fastener  
For 3/4" To 1" Moulding

UNIT PACKAGE: 25



**8386**

(GM: 4877001)  
Nylon

Rear Fender Lower Moulding  
Fastener  
For 1" To 1-1/4" Moulding

UNIT PACKAGE: 25



**8447**

(GM: 4886720,  
4417599)  
Nylon

Front & Rear Door  
Moulding Fastener  
For 1/2" To 5/8" Moulding

UNIT PACKAGE: 50



**8385**

(GM: 4877000)  
Nylon

Door & Fender Moulding Fastener  
For 3/4" To 1" Moulding

UNIT PACKAGE: 25

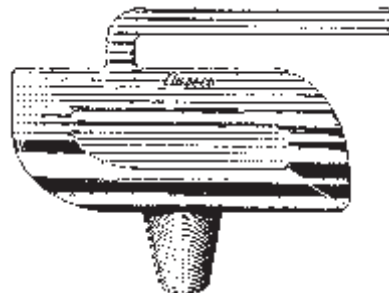

**8400**

Nylon

Moulding Fastener  
For 1-1/4" to 1-3/4" Moulding

UNIT PACKAGE: 25

### Rod End Ball Joints (Male)

**Bearing Raceway** - Locked in by annular groove-trunnion design. Made of fiber reinforced nylon.

**Outer Member (Housing)** - Low carbon steel, plated plus dichromate treated for corrosion resistance.

**Spherical Ball** - Precision make from selected low carbon steel-case hardened - file hard. Plated plus dichromate treated for corrosion resistance.

**Left Hand Thread** - Available with left hand thread in most sizes. Marked for easy user identification. Only Available Fully Assembled

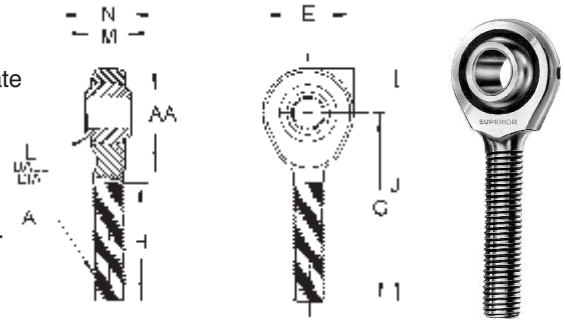

#### Dimensions

Auveco Part No.	Thread Size (A)	AA	E	G	H	J	L	M	N	Unit Pkg.	Thread
12268 12269	10-32	.189 .191	.625	1.250	.750	1.562	.438	.250	.312	1 1	R L
12270 12271	1/4-28	.250 .252	.750	1.562	1.000	1.937	.516	.281	.375	1 1	R L
12021 12272	5/16-24	.3125 .3145	.875	1.875	1.250	2.312	.625	.344	.437	1 1	R L
12022 12273	3/8-24	.375 .377	1.000	1.937	1.250	2.437	.719	.406	.500	1 1	R L
12485	7/16-20	.4395 .4375	1.125	2.125	1.312	2.687	.812	.437	.562	1	R
12023 12274	1/2-20	.500 .502	1.312	2.437	1.500	3.094	.938	.500	.625	1 1	R L
12024	5/8-18	.625	1.500	2.625	1.625	3.375	1.125	.562	.750	1	R
12486	3/4-16	.752 .750	1.750	2.875	1.750	3.750	1.312	.687	.875	1	R

### Rod End Ball Joints (Female)

**Bearing Raceway** - Locked in by annular groove-trunnion design. Made of fiber reinforced nylon.

**Outer Member (Housing)** - Low carbon steel, plated plus dichromate treated for corrosion resistance.

**Spherical Ball** - Precision make from selected low carbon steel-case hardened - file hard. Plated plus dichromate treated for corrosion resistance.

**Left Hand Thread** - Available with left hand thread in most sizes. Marked for easy user identification.

Only Available Fully Assembled

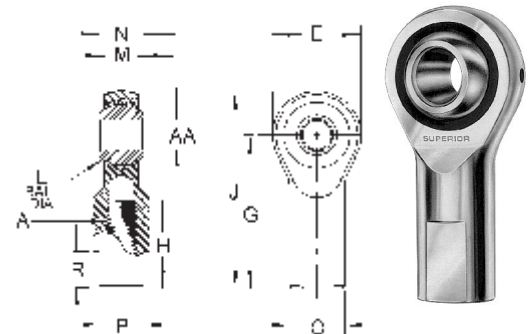

#### Dimensions

Auveco Part No.	Thread Size (A)	AA	E	G	H	J	L	M	N	O	P	R	Unit Pkg.	Thread
12025 12276	10-32	.189 .191	.625	1.062	.562	1.375	.438	.250	.312	.406	.312	.406	1 1	R L
12026 12277	1/4-28	.250 .252	.750	1.312	.750	1.687	.516	.281	.375	.469	.375	.406	1 1	R L
12027 12278	5/16-24	.3125 .3145	.875	1.375	.750	1.812	.625	.344	.437	.500	.437	.500	1 1	R L
12028 12279	3/8-24	.375 .377	1.000	1.625	.937	2.125	.719	.406	.500	.687	.562	.562	1 1	R L
12487	7/16-20	.4395 .4375	1.125	1.812	1.032	2.375	.812	.437	.562	.750	.625	.625	1	R
12029 12280	1/2-20	.500 .502	1.312	2.125	1.187	2.781	.938	.500	.625	.875	.750	.687	1 1	R L
12281	5/8-18	.625	1.500	2.500	1.500	3.250	1.125	.562	.750	1.000	.875	.875	1	R
12488	3/4-16	.752 .750	1.750	2.875	1.562	3.750	1.312	.687	.875	1.125	1.000	1.000	1	R

**Rod End Ball Joints (Male with Stud)**

**Bearing Raceway** - Locked in by annular groove-trunion design. Made of fiber reinforced nylon.

**Threaded Stud** - Made from medium carbon steel.

**Spherical Ball** - Precision make from selected low carbon steel-case hardened - file hard. Plated plus dichromate treated for corrosion resistance.

**Outer Member (Housing)** - Low carbon steel, plated plus dichromate treated for corrosion resistance.

**Left Hand Thread** - Available with left hand thread in most sizes. Marked for easy user identification.

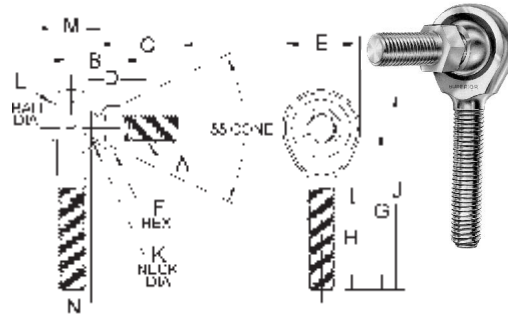

Only Available Fully Assembled

**Dimensions**

Auveco Part No.	Thread Size (A)	B	C	D	E	F	G	H	J	K	L	M	N	Unit Pkg	Thread
<b>12290</b>	10-32	.437	.437	.156	.625	.312	1.250	.750	1.562	.189	.438	.250	.312	1	R
<b>12292</b> <b>12293</b>	1/4-28	.469	.562	.156	.750	.375	1.562	1.000	1.937	.250	.516	.281	.375	1 1	R L
<b>12030</b>	5/16-24	.531	.687	.187	.875	.437	1.875	1.250	2.312	.312	.625	.344	.437	1 1	R
<b>12031</b> <b>12295</b>	3/8-24	.625	.875	.218	1.000	.500	1.937	1.250	2.437	.375	.719	.406	.500	1 1	R L
<b>12032</b>	1/2-20	.875	1.125	.312	1.312	.625	2.437	1.500	3.094	.500	.938	.500	.625	1	R

**Rod End Ball Joints (Female with Stud)**

**Bearing Raceway** - Locked in by annular groove - trunion design. Made of fiber reinforced nylon.

**Threaded Stud** - Made from medium carbon steel

**Spherical Ball** - Precision make from selected low carbon steel - case hardened - file hard. Plated plus dichromate treated for corrosion resistance.

**Outer Member (Housing)** - Low carbon steel, plated plus dichromate treated for corrosion resistance.

**Left Hand Thread** - Available with left hand thread in most sizes. Marked for easy user identification.

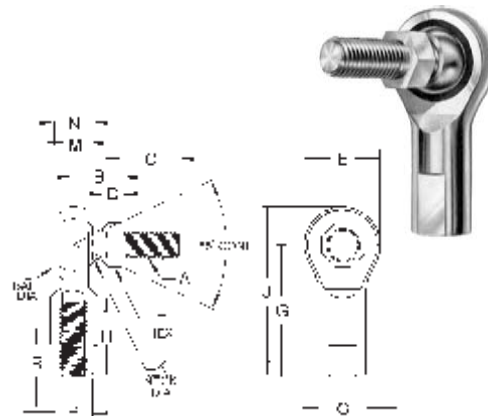

Only Available Fully Assembled

**Dimensions**

Auveco Part No.	Thread Size (A)	B	C	D	E	F	G	H	J	K	L	M	N	O	P	R	U. P.	The.
<b>12034</b> <b>12283</b>	10-32	.437	.437	>.1 56	.625	.312	1.062	.562	1.375	.189	.438	.250	.312	.406	.312	.406	1 1	R L
<b>12035</b> <b>12284</b>	1/4-28	.469	.562	.156	.750	.375	1.312	.750	1.687	.250	.516	.281	.375	.469	.375	.406	1 1	R L
<b>12036</b> <b>12285</b>	5/16-24	.531	.687	.187	.875	.437	1.375	.750	1.812	.312	.625	.344	.437	.500	.437	.500	1 1	R L
<b>12037</b> <b>12286</b>	3/8-24	.625	.875	.218	1.000	.500	1.625	.937	2.125	.375	.719	.406	.500	.687	.562	.562	1 1	R L
<b>12491</b>	7/16-20	.844	1.062	.312	1.125	.625	1.812	1.032	2.375	.437	.812	.437	.562	.750	.625	.625	1	R
<b>12038</b>	1/2-20	.875	1.125	.312	1.312	.625	2.125	1.187	2.781	.500	.938	.500	.625	.875	.750	.687	1	R
<b>12288</b> <b>12289</b>	5/8-18	1.00	1.125	.375	1.500	.750	2.500	1.500	3.250	.625	1.125	.562	.750	1.00	.875	.875	1 1	R L
<b>12492</b>	3/4-16	1.187	1.812	.375	1.750	1.00	2.875	1.562	3.750	.750	1.312	.687	.875	1.125	1.00	1.00	1	R

### Damper Control Swivels

The units are made from low carbon steel and are plated and dichromate treated for corrosion resistance. The set screws are made of low carbon steel, plated and dichromate treated for corrosion resistance. Set screws are case hardened. A rubber disc is used in the assembly.

Only Available Fully Assembled

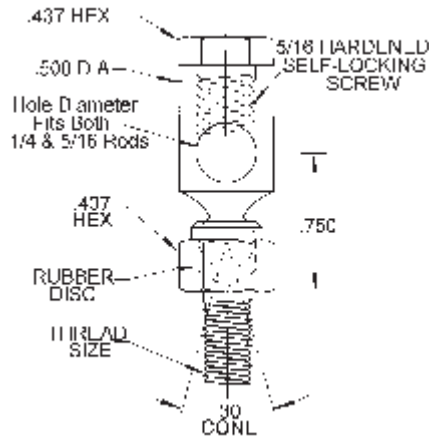

Thread Size	Damper Control Swivels			
	Auveco Part Number Less nut and washer	Unit Pkg	Auveco Part Number With nut and washer	Unit Pkg.
1/4-28 x 9/16"	<b>12303</b>	2	<b>12047</b>	3
1/4-20 x 7/16"	<b>12304</b>	2	<b>12048</b>	3
1/4-20 x 9/16"	<b>12305</b>	2	<b>12049</b>	3
5/16-24 x 3/4"	<b>12300</b>	2	<b>12307</b>	2

### Crank Arms (12 Gauge Steel)

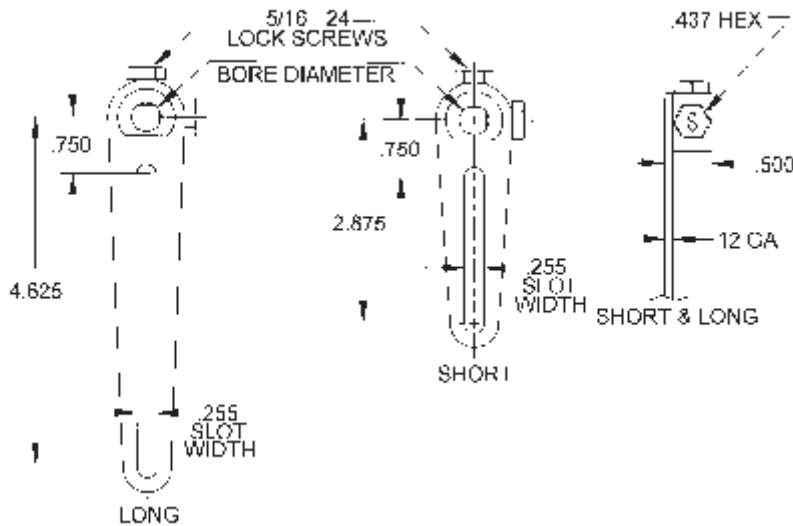

Auveco Part No.	Description	Bore Diameter	Unit Pkg.
<b>12050</b>	Short Series Crank Arm for 3/8" Shaft	.385/.389	1
<b>12052</b>	Long Series Crank Arm for 3/8" Shaft	.385/.389	1
<b>12053</b>	Long Series Crank Arm for 1/2" Shaft	.510/.514	1

# Sec. 24

# BALL JOINT ASSEMBLIES

## ("Flat Top"-Shur Seal)

Materials of construction - Made of low carbon steel with ball studs case hardened. Plated and dichromate treated for corrosion resistance.

Only Available Fully Assembled

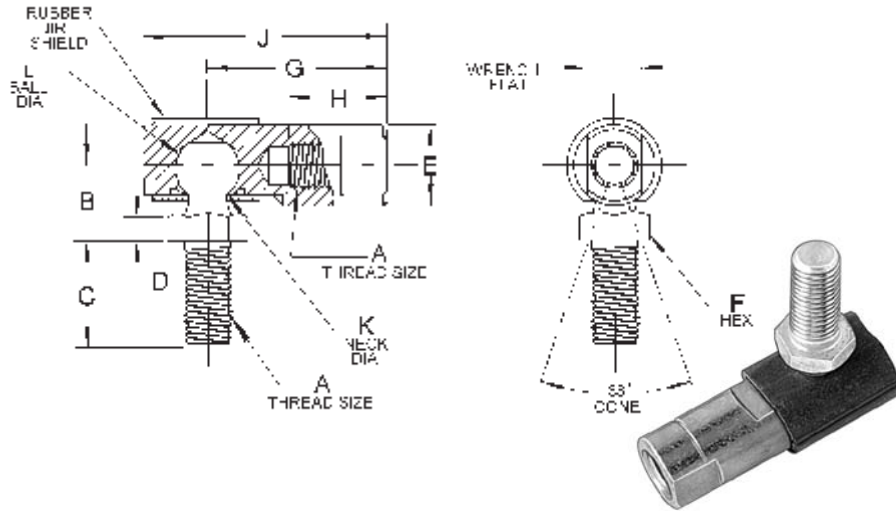

### DIMENSIONS

Auveco Part No.	Unit Pkg.	A	B	C	D	E	Wrench Size	F	G	H	J	K	L	Thread
<b>13580</b>	2	10-32	7/16	7/16	1/8	3/8	5/16	5/16	7/8	15/32	1-5/32	.177	.301	R
<b>12039</b>	3	1/4-28	15/32	9/16	1/8	7/16	3/8	3/8	31/32	17/32	1-5/16	.208	.347	R
<b>12040</b> <b>13590</b>	3 2	5/16-24	17/32	11/16	5/32	1/2	7/16	7/16	1-1/8	19/32	1-9/16	.250	.405	R L
<b>12041</b> <b>13591</b>	1 1	3/8-24	11/16	7/8	3/16	5/8	1/2	1/2	1-3/8	13/16	1-13/16	.289	.493	R L
<b>12042</b>	1	7/16-20	7/8	1-1/8	1/4	3/4	5/8	5/8	1-15/16	1-1/8	2-1/2	.375	.618	R
<b>12043</b>	1	1/2-20	7/8	1-1/8	1/4	3/4	5/8	5/8	1-15/16	2-1/8	2-1/2	.375	.618	R

## Quick Disconnect

"Key Hole" design on retaining sleeve insures positive alignment of sleeve with ball cavity.

Materials of construction - Body and ball are of low carbon steel, with ball studs case hardened. All components except stainless steel spring are plated and yellow dichromate treated for greater corrosion resistance.

Only Available Fully Assembled

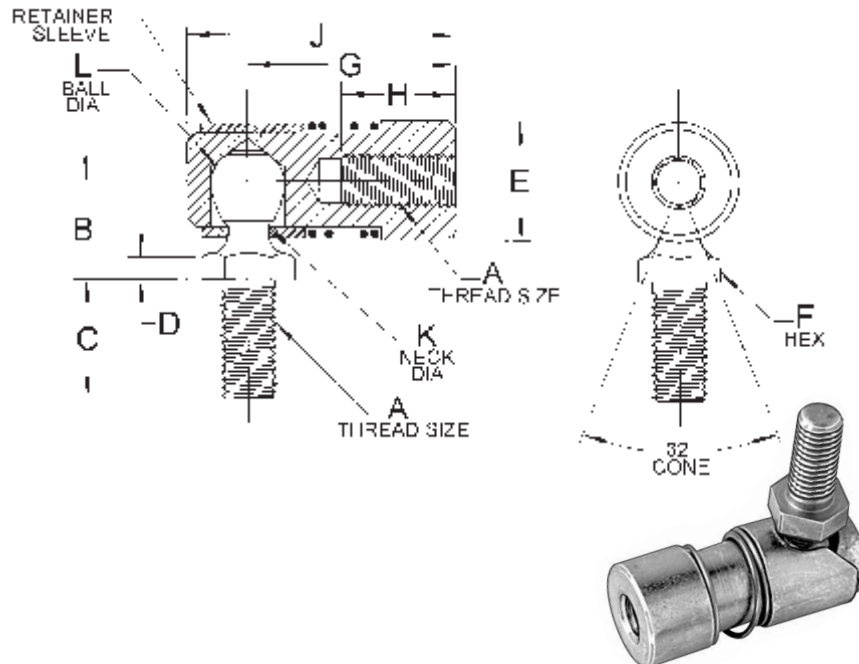

### DIMENSIONS

Auveco Part No.	Unit Pkg.	A	B	C	D	E	F	G	H	J	K	L
<b>12044</b>	2	1/4-28	15/32	9/16	1/8	9/16	3/8	31/32	17/32	1-1/4	.192	.347
<b>12045</b>	2	5/16-24	17/32	11/16	5/32	5/8	7/16	1-1/8	19/32	1-29/64	.224	.405
<b>13610</b>	1	3/8-24	11/16	7/8	3/16	3/4	1/2	1-3/8	13/16	1-3/4	.273	.493



# BALL JOINT ASSEMBLIES (Lightweight)



Materials of construction - Made of low carbon steel. Units are plated and dichromate treated for corrosion resistance. A rubber disc is used.

Only Available Fully Assembled.

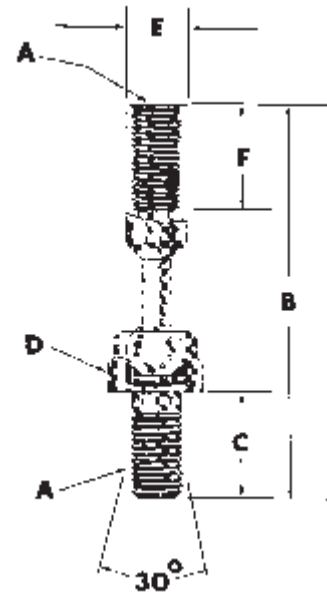

**DIMENSIONS**

Auveco Part No.	Unit Pkg.	G.M.C. Part No	A	B	C	D	E	F
<b>13606</b>	2	443773	1/4-28	2-3/32	9/16	7/16	5/16	9/16

**Disconnecting**

Materials of construction - Made of low carbon steel. Both ball stud and ball cavity are case hardened. Plated and dichromate treated for corrosion resistance. The retaining clip is heat treated spring steel, plated for corrosion resistance

Only Available Fully Assembled

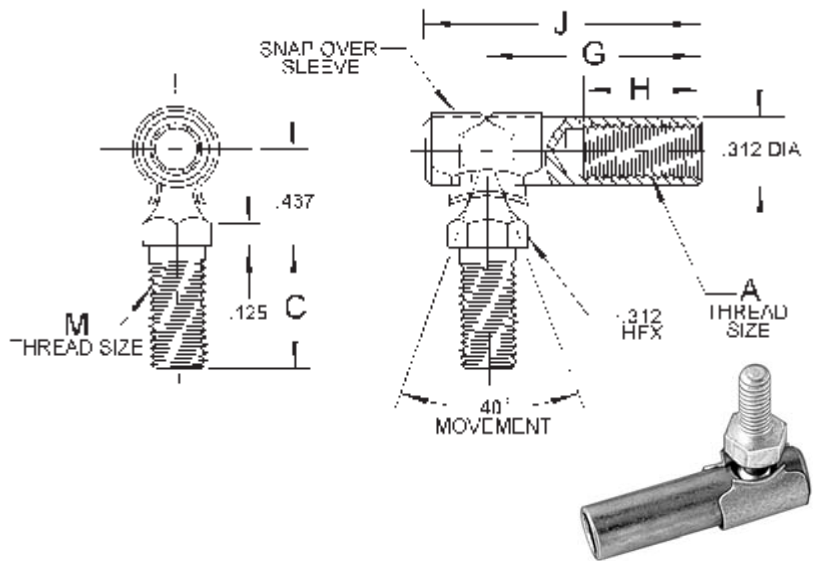

**DIMENSIONS**

Auveco Part No.	Unit Pkg.	A	C	G	H	J	M
<b>13599</b>	2	10-32NF	7/16	7/8	31/64	1-5/32	10-32NF
<b>13601</b>	2	10-32NF	9/16	7/8	31/64	1-5/32	1/4-28UNF
<b>13600</b>	2	1/4-28UNF	9/16	31/32	17/32	1-1/4	1/4-28UNF
<b>13602</b>	2	1/4-28UNF	7/16	31/32	17/32	1-1/4	10-32NF

# Sec. 24

# BALL JOINT ASSEMBLIES

## Spring Loaded

Materials of construction - Made of low carbon steel. Seat members are made of C1008 steel. Both ball stud and seats are case hardened. Assemblies are plated and dichromate treated for corrosion resistance.

Only Available Fully Assembled.

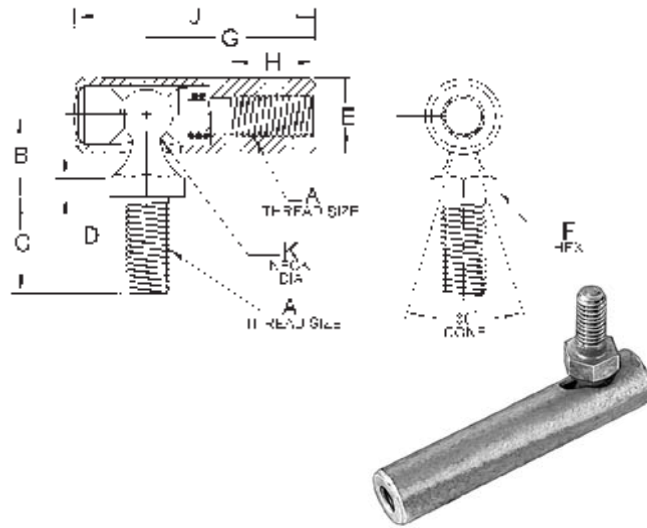

## DIMENSIONS

Auveco Part No.	Unit Pkg.	G.M.C. Part No.	G.M.C. Part No.	A	B	C	D	E	F	G	H	J	K
Spring Loaded													
<b>9866</b>	5	109398	91727	10-32	7/16	7/16	1/8	3/8	5/16	7/8	7/16	1-1/4	.125
<b>9867</b>	5	109400	192227	1/4-28	15/32	9/16	1/8	7/16	3/8	31/32	1/2	1-3/8	.151
<b>9868</b>	5	109401	426310	5/16-24	17/32	11/16	5/32	1/2	7/16	1-1/8	9/16	1-9/16	.182

## ("FLAT TOP")

Materials of construction - Made of low carbon steel with ball studs case hardened. Plated and clear dichromate treated for corrosion resistance.

Only Available Fully Assembled.

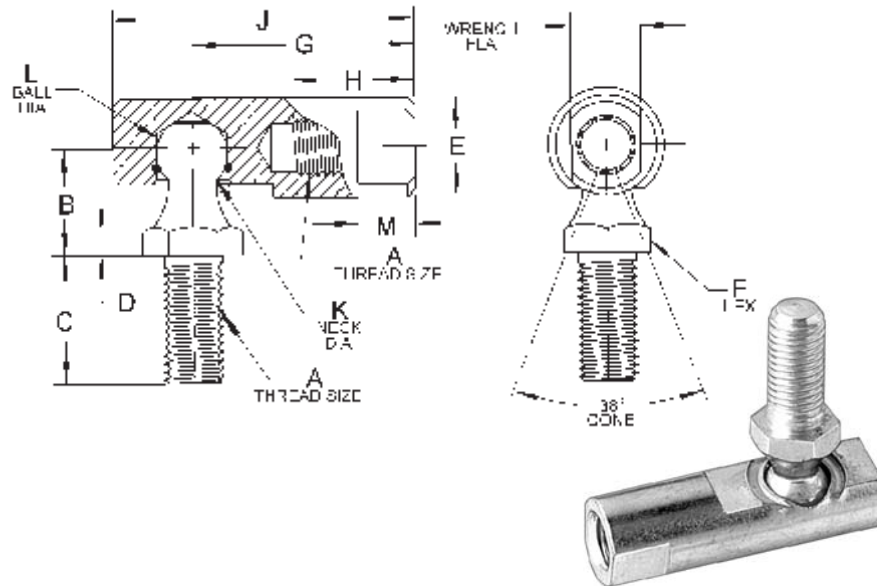

## DIMENSIONS

Auveco Part No.	Unit Pkg.	A	B	C	D	E	Wrench Size	F	G	H	J	K	L	Thread
<b>13581</b>	2	10-32	7/16	7/16	1/8	3/8	5/16	5/16	7/8	15/32	1-5/32	.177	.301	R
<b>13582</b>	2	1/4-28	15/32	9/16	1/8	7/16	3/8	3/8	31/32	17/32	1-5/16	.208	.347	R
<b>13584</b>	2	5/16-24	17/32	11/16	5/32	1/2	7/16	7/16	1-1/8	19/32	1-9/16	.250	.405	R
<b>9869</b>	5	3/8-24	11/16	7/8	3/16	5/8	1/2	1/2	1-3/8	13/16	1-13/16	.289	.493	R
<b>13586</b>	1	7/16-20	7/8	1-1/8	1/4	3/4	11/16	5/8	1-15/16	1-1/8	2-1/2	.375	.618	R
<b>13587</b>	1	1/2-20	7/8	1-1/8	1/4	3/4	5/8	5/8	1-15/16	1-1/8	2-1/2	.375	.618	R

# BALL JOINT ASSEMBLIES

Only Available Fully Assembled.



Ball Joint Assemblies  
Male and Female Thread, Spring Loaded  
Automotive Use - General Purpose.

Auveco Part No.	Thread Size	Unit Pkg.
<b>9866</b> .....	10-32 SAE .....	5
<b>9867</b> .....	1/4-28 SAE .....	5
<b>9868</b> .....	5/16-24 SAE .....	5

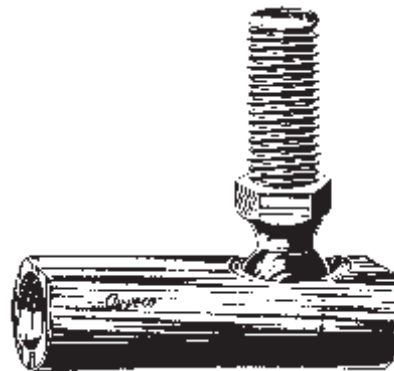

## 9869

Ball Joint Assembly  
3/8-24 Male and Female Thread  
Automotive Use - General Purpose

UNIT PACKAGE: 5



## 19182

Ball Joint Assembly  
1/4-28 SAE Male and Female Thread  
GM & Ford

UNIT PACKAGE: 2

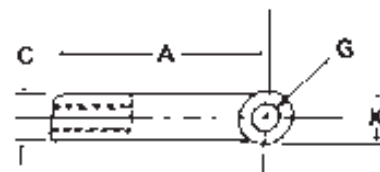
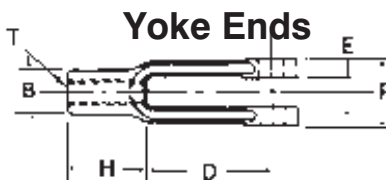

Zinc Finished Drop Forged Yoke Ends  
Adjustable

Auveco Part No.	"T" Tap Size	Dimensions In Inches									Unit Pkg.
		A	B	C	D	E	F	G	H	K	
<b>10737</b>	1/4-28	2	7/16	7/16	1-1/4	9/32	5/8	1/4	3/4	1/2	10
<b>10788</b>	1/4-28	2	7/16	7/16	1-1/4	9/32	5/8	1/4	3/4	1/2	2
<b>10738</b>	5/16-24	2-1/4	1/2	1/2	1-7/16	11/32	3/4	5/16	13/16	19/32	10
<b>10789</b>	5/16-24	2-1/4	1/2	1/2	1-7/16	11/32	3/4	5/16	13/16	19/32	2
<b>10739</b>	3/8-24	2-1/2	5/8	5/8	1-5/8	7/16	7/8	3/8	7/8	11/16	10
<b>10790</b>	3/8-24	2-1/2	5/8	5/8	1-5/8	7/16	7/8	3/8	7/8	11/16	2
<b>10740</b>	7/16-20	2-7/8	23/32	23/32	1-7/8	1/2	1	7/16	1	13/16	10
<b>10791</b>	7/16-20	2-7/8	23/32	23/32	1-7/8	1/2	1	7/16	1	13/16	2
<b>10741</b>	1/2-20	3	13/16	13/16	1-7/8	9/16	1-1/8	1/2	1-1/8	15/16	10
<b>10792</b>	1/2-20	3	13/16	13/16	1-7/8	9/16	1-1/8	1/2	1-1/8	15/16	2
<b>10742</b>	5/8-18	4-15/16	1-1/16	1-1/16	3-11/16	11/16	1-3/8	5/8	1-1/4	1-3/16	10
<b>10793</b>	5/8-18	4-15/16	1-1/16	1-1/16	3-11/16	11/16	1-3/8	5/8	1-1/4	1-3/16	2

For Clevis Pins see page 129 of this catalog.

**Sec. 25**

**HOSE CLAMPS**

**Crimp Type Hose Clamps**  
Zinc Plated

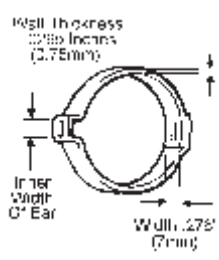

Position clamp on hose Give ear a firm squeeze

For low pressure applications such as automotive, appliance, industrial machinery, etc.

- Easy to Apply
- Simply Slide On and Clamp
- Sizes for all Hoses
- Ideal for Mass Production
- Clamps Tight
- Clamps Quickly
- Only One Simple Motion Needed
- "Full Round" Clamping Pressure
- No Gap Areas to Leak
- Low Profile-Out of the Way
- Avoids Hose Cutting and Abrasion

Part No.	Nominal Size	Inches		mm		Inner Width of Ear		Unit Pkg.
		Closed	Open	Closed	Open	Inches	mm	
18436	3/8"	.350	.414	8.9	10.5	.197	5	25
18437	7/16"	.381	.444	9.7	11.3	.197	5	25
18438	15/32"	.394	.486	10.4	12.3	.197	6	25
18439	1/2"	.453	.524	11.4	13.3	.236	6	25
18440	35/64"	.472	.551	11.9	14.0	.256	6.5	25
18441	9/16"	.496	.571	12.6	14.5	.236	6	25
18442	5/8"	.543	.618	13.8	15.7	.236	6	25
18443	11/16"	.594	.669	15.1	17.0	.236	6	25
18444	23/32"	.618	.728	15.7	18.5	.354	9	25
18445	3/4"	.669	.779	17.0	19.8	.354	9	25
18446	7/8"	.779	.890	19.8	22.6	.354	9	25
18447	1"	.898	1.008	22.8	25.6	.354	9	25

**Crimp Type Hose Clamp Tool**

**18448**



For installing and removing Auveco Crimp Type Hose Clamps 18436-18447.

UNIT PACKAGE: 1

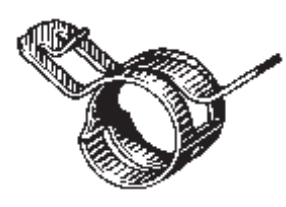

**Constant Tension Band Hose Clamps**

- For Heater & Radiator Hoses
- 1074 Spring Steel
- Black OEM Finish
- Conforms To SAE J1508 & GM 6298M
- Rated At 30 P.S.I.



Auveco Part No.	Clamping Range	Band Width	Unit Pkg.
18127	15.2mm - 18.5mm (5/8" - 23/32")	15mm (19/32")	10
18128	17.8mm - 20.0mm (23/32" - 25/32")	15mm (19/32")	10
18129	22.0mm - 26.0mm (7/8" - 1")	15mm (19/32")	10
18132	37.2mm - 44.5mm (1-15/32" - 1-3/4")	15mm (19/32")	5

# HOSE CLAMPS

## Wire Type Hose Clamps



Auveco Part No.	Hose Size O.D.	Unit Pkg.	Auveco Part No.	Hose Size O.D.	Unit Pkg.
5354	9/16"	50	5359	1"	50
5355	5/8"	50	16598	1-1/4"	50
5356	11/16"	50	16600	1-1/2"	25
5357	3/4"	50	16603	1-7/8"	10
17086	13/16"	50	16604	2"	10
5358	15/16"	50	17078	2-1/8"	10

## Hex Slotted Screw-Worm Gear Type-Hose Clamps

All Stainless Steel

Band-Saddle-Screw-Housing

300 Series Stainless (Non-Corrosive)

Screw Is 400 Series (Magnetic) Stainless

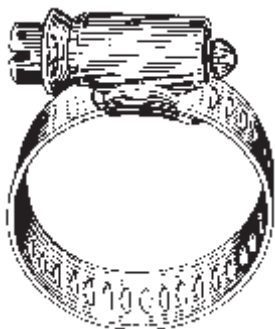

Auveco Part No.	Ind. Std. Size	Clamp Range Min.-Max.	Hose I.D. 3/16" Wall	Fits Plastic Pipe Size	Band Width	Unit Pkg.
9584	8	7/16" - 1"	5/16" to 1/2"	1/2" to 9/16"	9/16"	10
9585	10	1/2" - 1-1/8"	3/8" to 5/8"	1/2" to 3/4"	9/16"	10
9586	12	1/2" - 1-1/4"	5/8" to 3/4"	1/2" to 3/4"	9/16"	10
18483	16	3/4" - 1-1/2"	3/4" to 7/8"	1" to 1-1/4"	9/16"	10
9587	20	3/4" - 1-3/4"	1" to 1-1/4"	1" to 1-1/4"	9/16"	10
9588	24	1" - 2"	1-1/4" to 1-1/2"	1" to 1-1/2"	9/16"	10
9589	28	1-5/16" - 2-1/4"	1-1/4" to 1-3/4"	1-1/4" to 1-1/2"	9/16"	10
9590	32	1-9/16" - 2-1/2"	1-1/2" to 2"	1-1/2" to 2"	9/16"	10
9591	36	7/8" - 2-3/4"	1-3/4" to 2-1/4"	1-1/2" to 2"	9/16"	10
9592	40	1-1/8" - 3"	2" to 2-1/2"	2" to 2-1/2"	9/16"	10
9593	48	1-5/8" - 3-1/2"	2-1/4" to 3"	2-5/8" to 3"	9/16"	10
9594	52	1-7/8" - 3-3/4"	2-3/4" to 3-1/4"	3"	9/16"	10
9595	72	3-1/8" - 5"	3-3/4" to 4-1/2"		9/16"	10
9596	88	4-1/4" - 6"	4" to 5-1/2"	4"	9/16"	10
9597	96	4-3/4" - 6-1/2"	4-1/2" to 6"		9/16"	10
9598	104	5" - 7"	5-7/8" to 6-1/2"	6"	9/16"	10

## Hex Slotted Screw-Worm Gear Type-Hose Clamps

Partial Stainless Steel

300 Series Stainless Steel Band and Saddle

Plated Screw and Housing

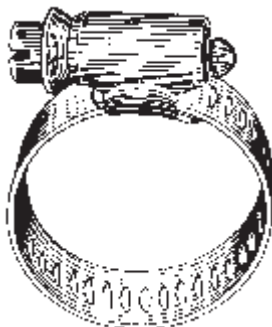

Auveco Part No.	Ind. Std. Size	Clamp Range Min.-Max.	Hose I.D. 3/16" Wall	Fits Plastic Pipe Size	Band Width	Unit Pkg.
5347	10	1/2" - 1-1/8"	3/8" to 5/8"	1/2" to 3/4"	9/16"	10
5348	12	1/2" - 1-1/4"	5/8" to 3/4"	1/2" to 3/4"	9/16"	10
18482	16	3/4" - 1-1/2"	3/4" to 7/8"	1" to 1-1/4"	9/16"	10
5349	20	3/4" - 1-3/4"	1" to 1-1/4"	1" to 1-1/4"	9/16"	10
5350	28	1-5/16" - 2-1/4"	1-1/4" to 1-3/4"	1-1/4" to 1-1/2"	9/16"	10
5351	32	1-9/16" - 2-1/2"	1-1/2" to 2"	1-1/2" to 2"	9/16"	10
5352	36	7/8" - 2-3/4"	1-3/4" to 2-1/4"	1-1/2" to 2"	9/16"	10
9357	48	1-5/8" - 3-1/2"	2-1/4" to 3"	2-1/4" to 2-3/4"	9/16"	10
9599	52	1-7/8" - 3-3/4"	2-3/4" to 3-1/4"	3"	9/16"	10
9358	72	3-1/8" - 5"	3-3/4" to 4-1/2"		9/16"	10
9600	88	4-1/4" - 6"	4" to 5-1/2"	4"	9/16"	10
9601	96	4-3/4" - 6-1/2"	4-1/2" to 6"		9/16"	10



No. 4

### 9324

Mini Clamp  
Stainless Steel Band  
w/Double Plated Hex Head  
Steel Screw  
Band Width 5/16"  
Minimum Range 1/4" - Maximum Range 5/8"

UNIT PACKAGE: 10



No. 6

### 10221

Mini Clamp  
Stainless Steel Band  
w/Double Plated Slotted  
Head Steel Screw  
Band Width 5/16"  
Minimum Range 1/2" - Maximum Range 7/8"

UNIT PACKAGE: 10

# HOSE CLAMPS

## Norma Torro (European Style) Hose Clamps

DIN 3017 • Stainless Steel Band & Housing • Zinc & Yellow Steel Screw

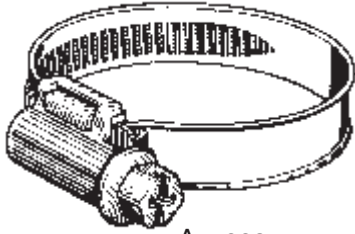

Unique off-set non-welded design of the housing provides resistance to over-tightening damage to the hose. The short housing saddle gives a smooth underside ensuring high sealing efficiency. These clamps are original equipment on both domestic and import vehicles. They are particularly suited for fuel, vacuum, water, emission and heater hoses and can be used with silicone hoses.

Auveco Part No.	Clamping Range	Hex Size	Band Width	Unit Pkg.
16868	8mm-12mm (5/16"-1/2")	6mm*	8mm (5/16")	10
16869	10mm-16mm (3/8"-5/8")	6mm*	8mm (5/16")	10
16870	12mm-18mm (1/2"-3/4")	6mm*	8mm (5/16")	10
16871	8mm-16mm (5/16"-5/8")	6mm	9mm (11/32")	10
16872	12mm-20mm (1/2"-3/4")	6mm	9mm (11/32")	10
16873	16mm-25mm (5/8"-1")	6mm	9mm (11/32")	10
16874	20mm-32mm (3/4"-1-1/4")	6mm	9mm (11/32")	10
16875	25mm-40mm (1"-1-5/8")	6mm	9mm (11/32")	10
16876	30mm-45mm (1-3/16"-1-3/4")	6mm	9mm (11/32")	10
16877	32mm-50mm (1-1/4"-2")	6mm	9mm (11/32")	10
16878	40mm-60mm (1-5/8"-2-3/8")	6mm	9mm (11/32")	10
19252	50mm-70mm (1-31/32" - 2-3/4")	6mm	9mm (11/32")	10
19253	60mm-80mm (2-3/8" - 3-1/8")	6mm	9mm (11/32")	10
19254	70mm-90mm (2-3/4" - 3-9/16")	6mm	9mm (11/32")	10

\*Phillips Hex Drive

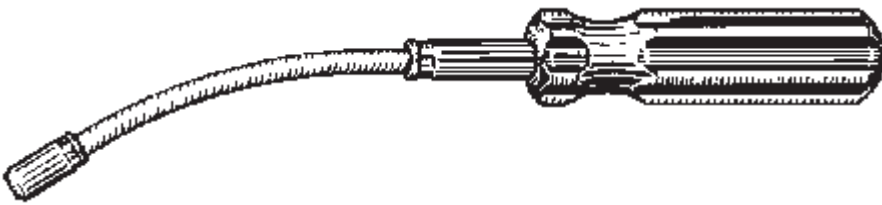

### 16879

Flexible Nut Driver  
For 6mm Hex  
Fits Auveco Hose Clamps  
16871-16878

UNIT PACKAGE: 1

### Type "G" Miniature Hose Clamp

They Grip 360° Around The Hose  
Zinc Plated

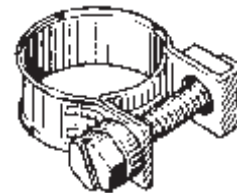
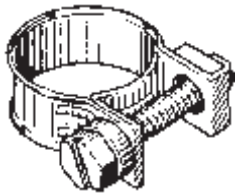

Auveco Part No.	Clamp Range Min.-Max	Hose I.D.	Band Width	Unit Pkg.	Auveco Part No.	Clamp Range Min.-Max	Hose I.D.	Band Width	Unit Pkg.
16766	8mm-10mm.....5/32".....9mm (11/32")	5/16"-13/32"	9mm (11/32")	10	15861	12.5mm-15mm.....5/16".....9mm (11/32")	1/2" - 19/32"	9mm (11/32")	10
16767	9.5mm-12mm.....7/32".....9mm (11/32")	3/8"-15/32"	9mm (11/32")	10	15862	13.5mm-16mm.....3/8".....9mm (11/32")	17/32"-5/8"	9mm (11/32")	10
15860*	10.5mm-13mm.....1/4".....9mm (11/32")	7/16"-1/2"	9mm (11/32")	10					

\*Zinc & Black Dichromate

# SINGLE BOND HOSE CLAMPS

Black Nylon



Auveco Part No.	Size	Clamping Range		Unit Pkg.
		Min.	Max.	
19558	1/4"	.246	.290	25
19559	5/16"	.300	.350	25
19560	11/32"	.360	.406	25
19561	13/32"	.410	.468	25
19562	15/32"	.475	.536	25
19563	17/32"	.538	.608	25
19564	19/32"	.597	.665	25
19565	43/64"	.670	.780	25
19566	3/4"	.730	.830	25
19568	61/64"	.953	1.093	25
19569	1-1/32"	1.031	1.187	25
19570	1-1/4"	1.250	1.425	10
19571	1-13/32"	1.406	1.610	10
19572	1-19/32"	1.593	1.812	10
19573	1-11/16"	1.790	2.110	10
19574	1-7/8"	1.870	2.125	10
19575	2-1/8"	2.120	2.390	10



## Spring Action Hose Clamps

Spring Steel, Heat Treated  
Phosphate and Paint

Auveco Part No.	Hose O.D.	Color	Max. Dia. Clamp in Free Position	Width	Unit Pkg.
12682	3/8"	Black	.321	5/16"	100
12683	7/16"	Green	.405	5/16"	100
12684	1/2"	Red	.460	5/16"	100
12685	9/16"	Black	.520	5/16"	100
12686	5/8"	Olive	.583	5/16"	100
12688	11/16"	Red	.655	5/16"	100
12689	3/4"	Black	.645	3/8"	100

# Sec. 25

# TUBING CLAMPS

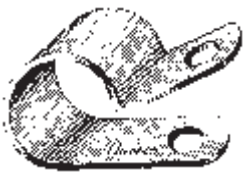

## Natural Nylon Tubing Clamps

Auveco Part No.	Hole Dia.	Width	Tube Dia.	Unit Pkg.
15525	3/16"	3/8"	1/8"	50
15526	3/16"	3/8"	3/16"	50
9246	3/16"	3/8"	1/4"	25
9247	3/16"	3/8"	5/16"	25
9248	3/16"	3/8"	3/8"	25
9249	3/16"	3/8"	1/2"	25
9250	3/16"	1/2"	5/8"	25
9251	3/16"	1/2"	3/4"	25
9252	3/16"	1/2"	1"	25

## Steel Clamps With Neoprene Jacket



Zinc Plated  
UNIT PACKAGE: 10

Auveco Part No.	Tube Size	Band Width	Mounting Hole Diameter
20502	1/4"	1/2"	17/64"
20503	3/8"	1/2"	17/64"
20504	1/2"	1/2"	17/64"
20505	5/8"	1/2"	17/64"
20506	3/4"	1/2"	17/64"
20507	7/8"	1/2"	17/64"
20508	1"	1/2"	17/64"
20509	1-1/4"	1/2"	17/64"
20510	1-1/2"	1/2"	17/64"
20511	1-3/4"	1/2"	17/64"
20512	2"	1/2"	17/64"



## Aluminum Tubing Clamps Plain Aluminum & Vinyl (PVC) Dipped

Auveco Part No.	Hole Dia.	Width	Tube Dia.	Unit Pkg.	Auveco Part No.	Hole Dia.	Width	Tube Dia.	Unit Pkg.
<b>Vinyl Dipped Aluminum</b>					<b>Plain Aluminum</b>				
17361	5/32"	3/8"	1/4"	15	17369	5/32"	3/8"	1/4"	50
17362	5/32"	3/8"	5/16"	15	17370	5/32"	3/8"	5/16"	50
17363	5/32"	3/8"	3/8"	15	17373	5/32"	3/8"	5/8"	50
17364	5/32"	3/8"	1/2"	15	17374	5/32"	1/2"	3/4"	25
17365	5/32"	3/8"	5/8"	15	17375	5/32"	1/2"	7/8"	25
17366	5/32"	1/2"	3/4"	15	17376	5/32"	1/2"	1"	50
17367	5/32"	1/2"	7/8"	15					
17368	5/32"	1/2"	1"	15					



## Insulated "Half" Clamps Galvanized Coated With Black Vinyl (1/32" Thick)

Auveco Part No.	Inside Diameter	Hole Diameter	Center To Center	Hole Center To End	Top of Radius To Base	Gauge	Width	Unit Pkg.
10608	3/16"	7/32"	7/16"	1/4"	5/32"	.032	1/2"	25
10609	1/4"	7/32"	1/2"	1/4"	7/32"	.048	1/2"	25
10610	5/16"	9/32"	17/32"	5/16"	9/32"	.048	5/8"	25
10611	3/8"	9/32"	9/16"	5/16"	11/32"	.048	5/8"	25
10612	7/16"	9/32"	5/8"	5/16"	13/32"	.060	5/8"	25
10613	1/2"	9/32"	11/16"	5/16"	15/32"	.060	5/8"	25
10614	5/8"	9/32"	13/16"	5/16"	9/16"	.060	5/8"	25
10615	3/4"	9/32"	7/8"	5/16"	11/16"	.060	5/8"	25



# STEEL INSULATED CLOSED CLAMPS

**Sec. 25**

Furnished Open  
Galvanized  
Coated With Black Vinyl (1/32" Thick)

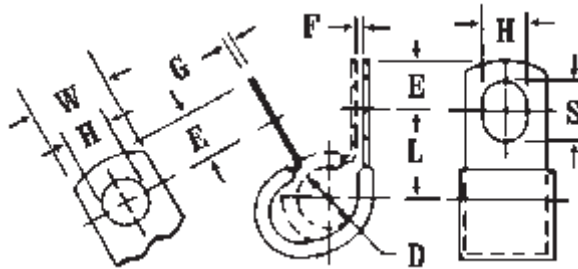

UNIT PACKAGE: 25 PCS.

Auveco Part No.	D	H	L	W	E	F	G	S
	Inside Diameter	Hole Diameter	Center to Center	Width	Hole Center To End	Gap	Gauge	Slot Length
<b>Small Hole Clamps</b>								
<b>17087</b>	3/16"	9/32"	1/2"	1/2"	5/16"	1/32"	.032"	3/8"
<b>9381</b>	1/4"	9/32"	17/32"	1/2"	5/16"	1/32"	.032"	3/8"
<b>9382</b>	5/16"	9/32"	9/16"	1/2"	5/16"	1/32"	.032"	3/8"
<b>9383</b>	3/8"	9/32"	19/32"	1/2"	5/16"	1/16"	.032"	3/8"
<b>9384</b>	1/2"	9/32"	21/32"	1/2"	5/16"	1/16"	.048"	3/8"
<b>9385</b>	5/8"	9/32"	23/32"	1/2"	5/16"	1/16"	.048"	3/8"
<b>9386</b>	3/4"	9/32"	25/32"	1/2"	5/16"	1/16"	.048"	3/8"
<b>9387</b>	7/8"	9/32"	27/32"	1/2"	5/16"	1/16"	.048"	3/8"
<b>9388</b>	1"	9/32"	29/32"	1/2"	5/16"	1/16"	.048"	3/8"
<b>Large Hole Clamps</b>								
<b>10598</b>	1/4"	13/32"	21/32"	3/4"	7/16"	1/32"	.032"	1/2"
<b>10599</b>	5/16"	13/32"	11/16"	3/4"	7/16"	1/32"	.032"	1/2"
<b>10600</b>	3/8"	13/32"	23/32"	3/4"	7/16"	1/16"	.032"	1/2"
<b>10601</b>	1/2"	13/32"	25/32"	3/4"	7/16"	1/16"	.048"	1/2"
<b>10602</b>	5/8"	13/32"	27/32"	3/4"	7/16"	1/16"	.048"	1/2"
<b>10603</b>	3/4"	13/32"	29/32"	3/4"	7/16"	1/16"	.048"	1/2"
<b>10604</b>	7/8"	13/32"	31/32"	3/4"	7/16"	1/16"	.048"	1/2"
<b>10605</b>	1"	13/32"	1-1/32"	3/4"	7/16"	1/16"	.048"	1/2"
<b>10606</b>	1-1/4"	13/32"	1-5/32"	3/4"	7/16"	1/16"	.048"	1/2"
<b>10607</b>	1-1/2"	13/32"	1-9/32"	3/4"	7/16"	1/16"	.048"	1/2"
<b>17588*</b>	1-3/4"	13/32"	1-13/32"	3/4"	7/16"	1/16"	.048"	1/2"
<b>17589*</b>	2"	13/32"	1-9/16"	3/4"	7/16"	1/16"	.048"	1/2"

\* Unit Package: 10

## Steel Uninsulated Closed Clamps Furnished Open

Galvanized  
UNIT PACKAGE: 25 Pcs.

<b>9389</b>	1/4"	9/32"	1/2"	1/2"	5/16"	1/32"	.032"	3/8"
<b>9391</b>	3/8"	9/32"	9/16"	1/2"	5/16"	1/32"	.032"	3/8"

**STOP EXCESSIVE COOLANT CONSUMPTION OR LEAKAGE!!!!**

**20574**  
 Engine Manifold  
 Repair Kit

UNIT PACKAGE: 1 Kit



2003 - 1995 GM vehicles with 3.8 L series 2 engines (VIN K - RPO L36) have been experiencing excessive coolant consumption or coolant leakage near or under the throttle body and intake manifold. This is caused when the EGR tube on the lower manifold degrades the composite material of the upper intake plenum around the passage area between the two part manifold. Once the composite material is degraded, it becomes porous and allows the coolant areas on either side of the EGR passage to leak coolant either internally or externally. If it leaks internally into the intake manifold and then the cylinders, it can result in "hydro-lock" of the engine. A simple coolant leak has resulted in a major problem that as best requires changing the spark plugs and oil in order to start the engine. That doesn't correct the cause of the problem though.

Until now, the solution has been to replace the upper plenum and lower manifold at a retail cost of \$1200 - \$1400 for parts and labor. Yet that alone does not correct the root cause of the problem. Our **20574 repair kit** offers an inexpensive but highly effective and permanent solution. Here are the steps involved:

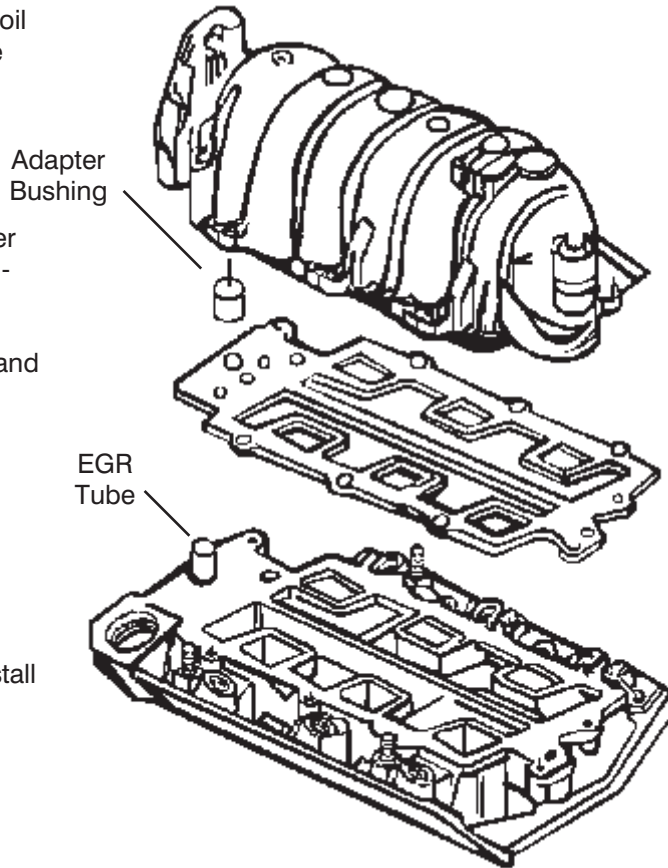

1. Remove the upper intake manifold.
2. Remove the EGR tube from the bottom plenum.
3. Install our new EGR port tube.
4. Use epoxy supplied with our repair kit to install our new adapter bushing in the upper plenum.
5. Reinstall the upper intake manifold.  
 (Detailed instructions are included with the kit)

As an added benefit, the smaller diameter of our EGR port tube creates an air space between the repaired (with adapter bushing) upper plenum and the new EGR port tube. This air space insulates the composite material of the plenum from further damage.

## Natural Color



### Part No. 1001

10.5 Fluid Ounces Per Cartridge  
(Green Colored Cartridge)

UNIT PACKAGE: 10 Cartridges

For use as a water and dust seal on exterior and interior body surfaces. New improved formula allows for a longer open time so it can be tooled for several minutes after being applied. Cures to a firm abrasion resistant seal with no cracks or peeling. Can be air dried or force dried and then painted within 30 minutes

Stands up on vertical surfaces and won't crack even in large seams. Ideal for drip molds, interior trunk welds, exterior body seam welds and many other body seam areas. Possesses excellent flexibility properties so it will not harden or become brittle.

Excess sealer and smears can be cleaned up with a suitable solvent before sealer dries. Sealer surface accepts all paints and must be painted. Shelf life is 6 months.

---

## Seam-N-Joint Sealer

### Natural Color

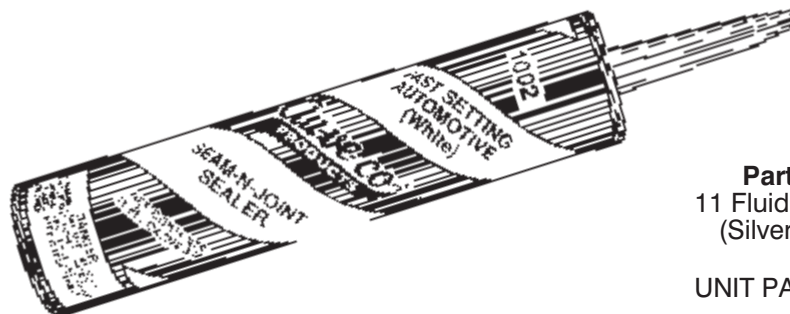

### Part No. 1002

11 Fluid Ounces Per Cartridge  
(Silver Colored Cartridge)

UNIT PACKAGE: 10 Cartridges

Premium quality, fast setting seam-n-joint sealer with superior adhesion for interior and exterior automotive applications (except windshields). Its self-leveling qualities make it an excellent sealer on quarter panel seams, trunk seams, wheel house seams, floor seams, cowl seams and door skins.

**1002** smooths easily so rough edges and fingerprints disappear. Possesses superior flexibility properties thus eliminating any cracking or peeling. Skin time is 1-2 minutes. Can be painted with any type of paint in 30-60 minutes. Shelf life is 6 months.

**Distributors: Auveco 1001 and 1002 can be combined for price breaks and prepaid freight.**

# EPOXY REPAIR KITS

## Flexible Setting Epoxy Repair Kit

Part No. **1003**

UNIT PACKAGE: 2 Tubes: 1 Each Of Part 1 (Dark Gray) and Part 2 (White)  
(16 oz. Kit)



A Flexible Epoxy Repair Compound for the Auto Body Shop which Sets in 6-8 Minutes. It has Strong Adhesion to all Surfaces plus Excellent Paint Adhesion.

Make Difficult Repairs to Flexible Expensive Parts In One Hour  
Easy To Use 2 Part Equal Mix

Non Brittle-Excellent Feather Edging  
Retains Flexibility When Cured  
Chemical Resistant-Non Shrinking-Tough and Durable

Use to Repair Cuts, Holes, Tears and Gouges on Rubber Bumpers, Flexible Header Panels, and Filler Strips (exc. polyethylene and polypropylene).

Shelf life: 12 months

---

## Hard Setting Epoxy Repair Kit

Part No. **1004**

UNIT PACKAGE: 2 Tubes: 1 Each Of Part 1 (Light Gray ) and Part 2 (White)  
(16 oz. Kit)



A Rigid Setting Epoxy Repair Compound for the Auto Body Shop Which Sets in 6-8 Minutes. It is Extremely Strong yet not Brittle. It Cures Rapidly in any Thickness, has excellent Paintability and is Chemical Resistant.

Sandable In 30 Minutes  
Easy To Use 2 Part Mix

Strong-Excellent Feather Edging  
Difficult Repairs Made in Minutes

Use to Repair Header Panels, Carburetors, Batteries, Gas Tanks, Rubber Bumpers, and Filler Strips (exc. polyethylene and polypropylene)

Use in Industry or Home-Boats-Tools-Wood-Aircraft-Sporting Equipment-Ceramics.

Shelf life: 12 months

---

# FIXIT QUICK EPOXY PUTTY

Sec. 26



Auveco Part No. **1007** - 1 Tube (4 oz.)

Auveco Part No. **1008** - 1 Case (24-4oz. tubes)

## Hardens Like Steel in 20 Minutes

Fix-it Quick will plug or seal practically anything that leaks, it will patch holes and cracks, mend almost anything that is broken. It is excellent for rebuilding or fabricating parts and as an all purpose adhesive for metals, wood, glass, masonry, ceramics and many plastics. Also, it can be drilled, tapped, filed, sanded and painted like metal. Sets steel hard in 20 minutes.

## Hints For Use

- FixitQuick adheres to most surfaces. Best results will be achieved if area is first roughened by sanding or filing to clean and prepare surface.
- Starts to harden 2 minutes after mixing. Repair should be in place before hardening starts.
- A smooth finish can be obtained by rubbing with wet finger or damp cloth before hardening begins.
- FixitQuick can be drilled, filed, tapped sanded and machined after one hour of curing (hardening).
- Can be painted immediately, even before full hardening.
- FixitQuick can be used under water. Mix as usual and use the polyethylene wrapper, so material will not stick to hands as the FixitQuick is being forced onto the wet surface.
- Not recommended for use on polyethylene and polypropylene.
- Wash hands thoroughly with soap and water after using FixitQuick.

## Mixing Directions

1. Break off required portion of material.
2. Twist and knead until uniform color is achieved-no streaks.
3. Apply At Once to surface. (2 minute work life).
4. Remove excess before it hardens.

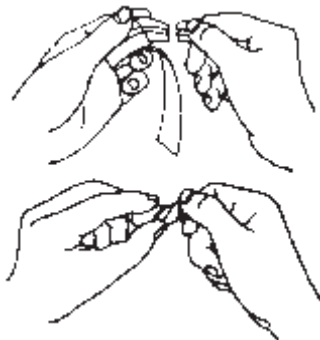

## Infinite Uses

U.S.D.A. Authorized

**Plumbing Repairs** - Sink traps, oil and water tanks, pipe joints, drain leaks, etc.



**Electrical** - Use in place of tape, ceramic connectors, knobs, etc.



**Ceramic Repair** - Cracked porcelain wall tile, floor tile, etc.



**Auto Repair** - Metal Strips, small dent repairing, fuel tank, radiators, etc.



**Underwater Repair** - Concrete swimming pools, fish tanks, etc.



**Custom Formed Gaskets** - For permanent sealing and bonding.



**Home Repairs** - Dethreaded screws in wood or metal, picture hanging, light fixture installation, fixing loose rungs and legs on furniture, air duct leaks, etc.



Safe for lines carrying potable water.

### Physical Properties

Density	15.8 lb./gal. (1.9gm/cm <sup>3</sup> )
Compression Strength	18,000 psi
Tensile Strength	6,000 psi
Modulus of Elasticity	600,000 psi
Shear Strength	700 psi
Izod Impact	0.3 ft.-lb/in. of notch
Hardness (Shore D)	85
Maximum Use Temperature	300°F (149°C)

### Electrical Properties

Volume Resistivity	5 x 10 ohm-cm
Dielectric Strength	400 volts/mil @ 0.125 in.

**WARNING:** Harmful if swallowed, Eye irritant. Contains epoxy and amine resins. Keep away from children. If swallowed, call physician. For eyes, flush with water and call physician.

**MISCELLANEOUS ITEMS**

**Solder Paste**

**Works With The Head Of A Match, Lighter, Soldering Iron Or Torch.**

Five times stronger than ordinary Solder. Provides strength without the distortion of high temperature brazing.

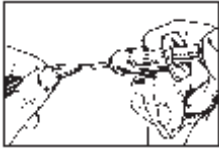

1) Apply Solder Paste



2) Apply heat until paste begins to bubble



3) Solder will solidify



**20409**

Silver Bearing Solder Paste

For Ferrous and Non-Ferrous Metals: steel, cast iron, stainless steel, brass, bronze, nickel, platinum, chrome, monel, galvanized, gold & silver. Auto electrical systems, circuit boards, etc. Flows freely at 430° F. Tensile Strength: 10,000 to 25,000 PSI. 7.1 grams syringe

UNIT PACKAGE: 1

**20410**

Copper Bearing Lead-Free Solder Paste

For use with copper. Also works on brass, stainless steel, nickel and bronze. Does not contain any lead, cadmium or antimony. Flows freely at 430° F. Tensile strength: 10,000 to 25,000 PSI. 14.7 grams syringe

UNIT PACKAGE: 1



Pin Diameter: 2mm (.080")  
Length: 2"  
Head Diameter: .145"

**19095** UNIT PACKAGE: 100  
**19096** UNIT PACKAGE: 250  
**19097** UNIT PACKAGE: 500

**Weld Pins**

Round Head • Copper Plated Steel

By welding these pins to a damaged body panel, a body shop technician can use a gripping tool to pull the dent out of the panel.



Pin Diameter: 2.5mm (.098")  
Length: 2"  
Head Diameter: .175"

**19098** UNIT PACKAGE: 100  
**19099** UNIT PACKAGE: 250  
**19100** UNIT PACKAGE: 500

**TRANSPARENT DUCT TAPE**

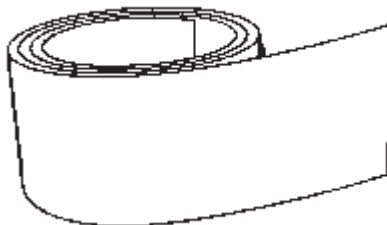

- 1-7/8" x 20 Yards
- Water Resistant
- UV Resistant
- Excellent Adhesion

**20676**

UNIT PACKAGE: 1 Roll

**20679**

UNIT PACKAGE: 1 Case of 12 Rolls

# MISCELLANEOUS ITEMS

## Velcro Hook And Loop Fasteners

Velcro brand nylon hook and loop fasteners consist of two mating tapes: hook and loop. When the two tapes are pressed together, the hooks engage the loops forming an adjustable, secure and completely jam proof closure. To reopen the closure, simply peel apart.

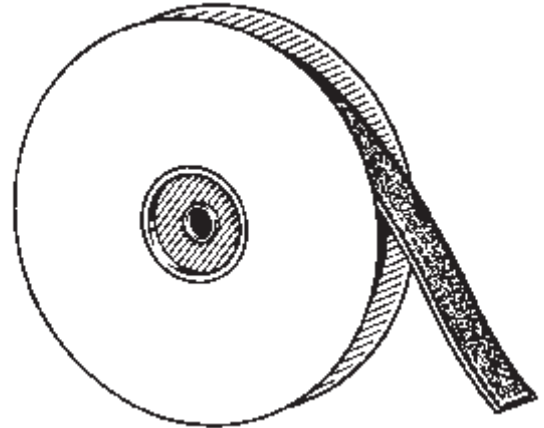
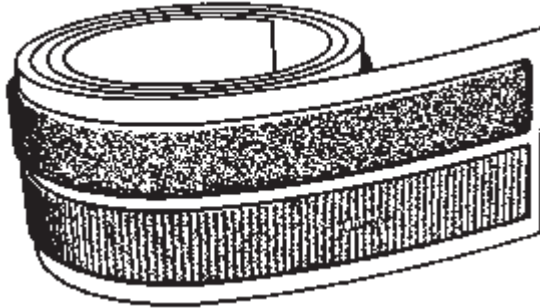

**17181 (Color: Black)**

**19827 (Color: White)**

VelcroStrips

48" long strips of 3/4" wide hook and loop material with adhesive backing on one roll.

UNIT PACKAGE: 1 Roll

**17546 (Color: Black)**

VelcroStrips

5 yard long strips of 3/4" wide hook and loop material with adhesive backing on one roll.

UNIT PACKAGE: 1 Roll

**17182 (Color: Black)**

Spooled Velcro Hook Material

25 yard long spool of 1" wide hook strip with adhesive backing.

UNIT PACKAGE: 1 Spool

**17183 (Color: Black)**

**19829 (Color: White)**

Spooled Velcro Loop (Fuzzy) Material

25 yard long spool of 1" wide loop strip with adhesive backing.

UNIT PACKAGE: 1 Spool

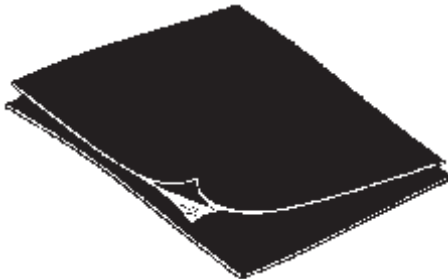

**16506**

12" x 12" x .060" thick pads with adhesive backs. Can be cut to shape and painted for easy installation. The clear vinyl sheet on the black side must be removed before painting. Meets GM specification #2747M.

UNIT PACKAGE: 6

## Gloves

Available In Vinyl Or Latex

Form Fitting Fits Right or Left Hand • Lightly Dusted with Corn Starch • Non-Sterile



Size	Latex Auveco Part No	Vinyl Auveco Part No.
Small	<b>16005</b>	-----
Medium	<b>16006</b>	-----
Large	<b>16007</b>	<b>19551</b>

Each size packaged 100 gloves (50 pairs) per box.

Note: Not For Immersion In Chemicals

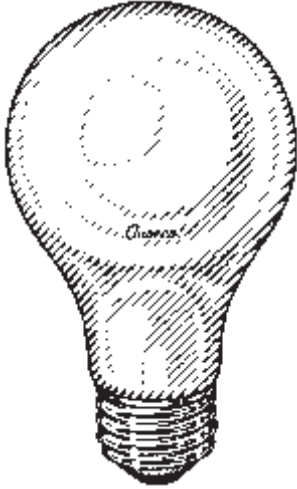

**Rough Service**  
Long Life Light Bulbs

The Rough Service bulb features a special filament that withstands shock and vibration. It was designed exclusively for the automotive service industry. The brass base eliminates "freezing" or corroding in the socket; however, it will explode if it comes in contact with a liquid.

**16570**  
Rough Service  
75 Watt

UNIT PKG: 6

**16571**  
Rough Service  
75 Watt

UNIT PKG: 120  
(1 Case of  
20 Six-Paks)

**16572**  
Rough Service  
100 Watt

UNIT PKG: 6

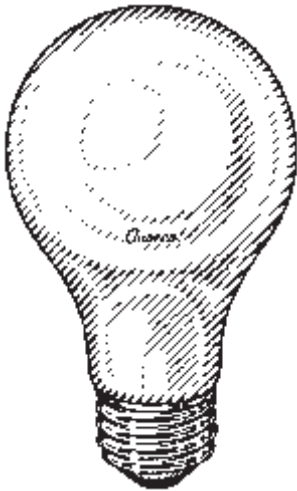

Long Life Light Bulbs

Super Tough out's amazing silicon coating makes it the safest, sturdiest light bulb ever developed. Patented coating protects personnel and products from shattered glass caused by impact, dropping, unusual stress, contact with liquids and thermal shock. Brass base eliminates "freezing" or corroding in the socket.

Super Tough out  
75 Watt

UNIT PKG: 6

**16575**  
Super Tough out  
100 Watt

UNIT PKG: 6



# MISCELLANEOUS ITEMS

**Sec. 27**

## Acid Brushes



Tin Handle Horse Hair Bristles

Auveco Part No.	Width	Trim	Length	Unit Pkg.
15793	1/4"	3/4"	6"	1 Gross
15794	3/8"	3/4"	6"	1 Gross
15795	1/2"	13/16"	6"	1 Gross
15796	9/16"	7/8"	6"	1 Gross
15797	5/8"	1"	6-1/4"	1 Gross
15798	3/4"	1"	6-3/8"	1 Gross

## Chip Brushes



Wood Handle Natural Bristles

Auveco Part No.	Width	Trim	Unit Pkg.
15800	1-1/2"	1-5/8" x 5/16"	5
15801	2"	1-1/2" x 5/16"	4

## Chip & Dope Brush

Wood Handle Horse Hair Bristles

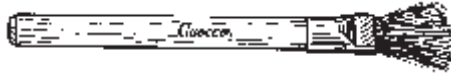

Auveco Part No.	Width	Trim	Length	Unit Pkg.
15799	11/16"	1-1/8"	7"	25

## Steel Wire Scratch Brushes



Type 1

Wood Handle

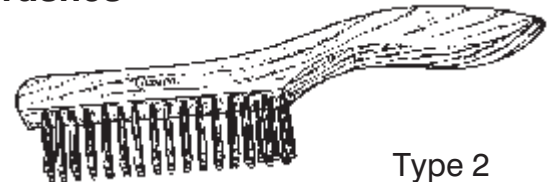

Type 2

Auveco Part No.	Type	Size of Block	Rows	Trim	Wire	Unit Pkg.
15803	1	14" x 1"	3 x 19	1-3/16"	33 Gauge Steel	1
15805	2	10" x 1-1/8"	4 x 16	1-3/16"	33 Gauge Steel	1

## Bin Labels

(Refer To Page 274 For Additional Information)

2" x 3/4" Pressure Sensitive Bin Labels Covering Popular Size U.S.S., S.A.E. And Metric Fasteners.  
36 Labels Per Each 6-1/4" x 9" Page.



- 15531 U.S.S. Fasteners -6 Pages
  - 15532 S.A.E. Fasteners -6 Pages
  - 14773 Miscellaneous Fasteners -6 Pages
  - 14774 Metric Fasteners -9 Pages
  - 14775 Blank Labels -5 pages
  - 15533 Bin Label Assortment
- 1 Each Of 15531, 15532, 14773, 14774, & 14775

All Packed 1 Set

**Sec. 27**

**MISCELLANEOUS ITEMS**

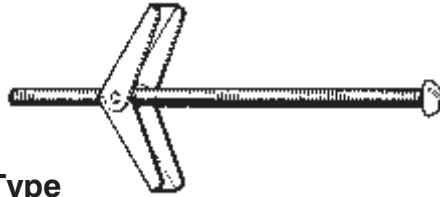
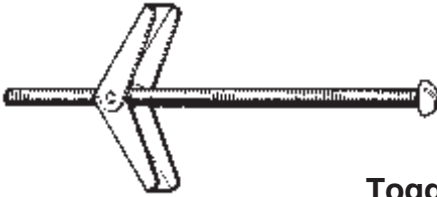

**Toggle Bolts Spring Wing Type**

Auveco Part No.	Head Style	Screw Diameter	Thread Size	Use Drill	Unit Pkg.
10011	Mushroom	1/8"	6-32 x 3"	3/8"	10
10012	Mushroom	1/8"	6-32 x 4"	3/8"	10
10013	Round Slotted	3/16"	10-24 x 3"	9/16"	10
10014	Round Slotted	3/16"	10-24 x 4"	9/16"	10
10018	Round Slotted	1/4"	1/4-20 x 4"	3/4"	10

**Plastic Screw Anchors**



Auveco Part No.	Screw Size	Hole Size	Length	Color	Unit Pkg.
9984	14-1/4"	5/16"	2-1/4"	Blue	25
9986	3/8"	7/16"	3"	Gray	10

**Nylon Anchors**

Steel Nail

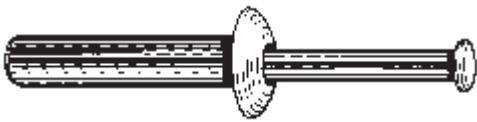

**Hammer Drive Anchors  
All Steel**

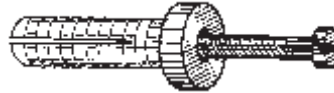

Auveco Part No.	Size	Hole Size	Unit Pkg.	Auveco Part No.	Size	Head Style	Unit Pkg.
12857	3/16" x 7/8"	3/16"	25	12866	3/16" x 1-1/2"	Round	25
12858	1/4" x 3/4"	1/4"	25	12869	1/4" x 1"	Round	25
12859	1/4" x 1"	1/4"	25	12870	1/4" x 1"	Mushroom	25
12860	1/4" x 1-1/4"	1/4"	10	12871	1/4" x 1-1/2"	Round	25
12861	1/4" x 1-1/2"	1/4"	10	12872	1/4" x 2"	Mushroom	25
12862	1/4" x 2"	1/4"	10				

**Hex Nut  
Masonry Anchors**



Auveco Part No.	Hole Size	Effective Anchor Length	Fastens Material Up to	Unit Pkg.
12875	3/8"	3"	1-3/4"	10



**Hollow Wall Anchors  
Drive Type**

Auveco Part No.	Size	Wall Thickness	Drill Size	Unit Pkg.
12889	1/8" Short	1/8" to 1/2"	1/4"	10
12890	1/8" Long	5/8" to 7/8"	1/4"	10
12891	1/8" Int.	1/8" to 7/8"	5/16"	10



**Plastic Anchors**

Auveco Part No.	Screw Size	Drill Size	Unit Pkg.
10005	#6-#8	3/16"	50
12851	#8-#10	3/16"	50
10006	#10-#12	1/4"	50
12852	1/4"-5/16"	5/16"	50



**Machine Screw Anchors  
Rust Proof Type**

Auveco Part No.	Screw Size	Drill Size	Unit Pkg.
9998	#10-24	3/8"	25
9999	1/4"-20	1/2"	25
10002	5/16"-18	5/8"	25
10003	3/8"-16	3/4"	10

Note: One Setting Tool Included w/Each Box.

**Lag Screw Shields**



Auveco Part No.	Screw Size	Length	Drill Size	Unit Pkg.
9992	1/4"	Long	1/2"	10
9994	3/8"	Long	5/8"	10
9995	1/2"	Long	3/4"	5



**Hollow Wall Anchors**

Auveco Part No.	Size	Wall or Surface Thickness	Unit Pkg.
10008	1/8" Long	5/8" to 1-1/4"	10
10009	3/16" Short	1/8" to 5/8"	10
10010	3/16" Long	5/8" to 1-1/4"	10
12831	1/4" Short	1/8" to 5/8"	10
12832	1/4" Long	5/8" to 1-1/4"	10



**E-Z Anchor™**

Self-drilling, one-piece anchor for mounting to gypsum wallboard  
Zinc Plated

**16024**

Use With #8 Screw in 3/8" -5/8" Wallboard

No pre-drilling or hole preparation  
Installs with #2 Phillips Screwdriver.  
No electric drill necessary. Can be easily backed out.

UNIT PACKAGE: 25



**Heavy Duty Utility Hook**

Auveco Part No.	Hole Size	Length	Unit Pkg.
12829	Screws to 1/4"	1-1/4"	25

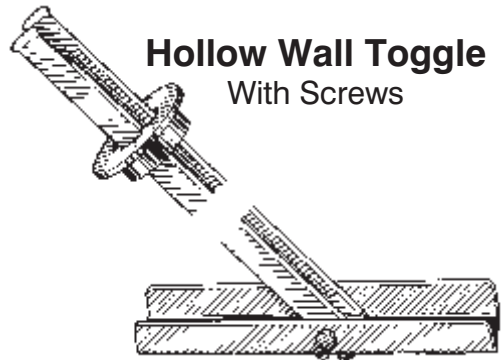

**Hollow Wall Toggle  
With Screws**

Auveco Part No.	Toggle Size	Screw Length	Hole Size	Unit Pkg.
12833	1/8"	2"	3/8"	10
12834	3/16"	2"	1/2"	10
12835	1/4"	2"	5/8"	10

# Sec. 27

# MISCELLANEOUS ITEMS

## Screw Pin Anchor Shackles



Galvanized Weldless Drop Forged Stud. Sizes 3/16" Thru 3/4" have Alloy Pins

Auveco Part No.	Size Inches	Length Inside Inches	Dimensions Between Eyes Inches	Diam Pin Inches	Safe Working Load Tons	Unit Pkg.
12184	5/16"	1-1/4"	9/16"	3/8"	3/4"	1
12185	3/8"	1-1/2"	5/8"	7/16"	1"	1
12187	1/2"	2"	7/8"	5/8"	2"	1
12188	5/8"	2-1/2"	1-1/8"	3/4"	3-1/4"	1
12189	3/4"	2-7/8"	1-3/16"	7/8"	4-3/4"	1
12191	1"	3-1/2"	1-5/8"	1-1/8"	7-1/2"	1

## Wire Rope Thimbles

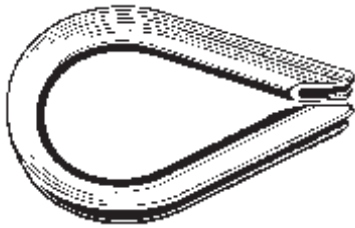

Galvanized Stud

Auveco Part No.	For Diam. Rope Inches	Outside Width Across Score	Width Inside Inches	Length Overall Inches	Unit Pkg.
12192	1/8"	9/32"	23/32"	1-3/4"	10
12194	1/4"	3/8"	23/32"	1-3/4"	10
12195	5/16"	7/16"	27/32"	2-3/4"	10
12196	3/8"	9/16"	31/32"	2-1/4"	10
12197	1/2"	21/32"	1-5/32"	2-1/2"	10
12198	5/8"	27/32"	1-13/32"	2-7/8"	5

## Connecting Links



Galvanized-Self Closed Heat Treated Drop Forged Stud With Interlocking Lugs\*

Auveco Part No.	Size	Outside Dimensions	Weight Per 100 in Lbs.	Unit Pkg.
12204	*5/16"	1-3/4" x 1-1/4"	11	2
12207	1/2"	2-5/8" x 1-3/4"	33	1
12208	5/8"	3-1/4" x 2-1/8"	73	1

\*5/16" has no interlocking lugs. When riveted down, the pins securely lock the lugs together, making the links as strong as proof chain.

## "Nipper" Wire Rope Clip



Galvanized Malleable Iron Base Zinc Plated Stud U-bolt

Auveco Part No.	For Diam. Rope	Diam.	U-Bolt Dimensions Length Overall	Center to Center	Unit Pkg.
12171	1/8"	3/16"	1"	1/2"	6
12172	3/16"	1/4"	1-1/16"	9/16"	6
12173	1/4"	5/16"	1-1/2"	11/16"	6
12175	3/8"	3/8"	2"	7/8"	4
12177	1/2"	7/16"	2-3/8"	1"	4
12179	3/4"	9/16"	3-1/16"	1-11/32"	2

## Type 1



## Type 2

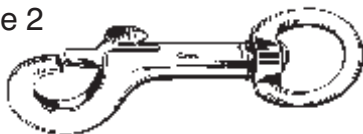

## Bolt Snaps

Malleable Iron • Cadmium Plated

Auveco Part No.	Type	Size of Eye	Overall Length	Ring Size Snap Opening	Unit Pkg.
12166	1	3/8"	4"	3/8"	2
12168	2	1/2"	3-15/16"	3/8"	2
12169	2	5/8"	4"	3/8"	2
12170	2	3/4"	4-3/32"	3/8"	2

# MISCELLANEOUS ITEMS

## Nylon Spacer Bushings (Stand-Offs)



Tough and resilient white nylon spacer bushings are ideal for use in electrical and electronic applications or anywhere a slip surface is needed. They can be used as bushings, bearings, rollers, glides or separators.

Auveco Part No.	I.D.	O.D.	Length	Unit Pkg.
<b>16196</b>	.140"	1/2"	1/8"	100
<b>16198</b>	.257"	1/2"	1/4"	100
<b>16200</b>	.257"	1/2"	3/8"	100
<b>16202</b>	.257"	1/2"	1/2"	100
<b>16204</b>	.257"	1/2"	5/8"	100
<b>16205</b>	.257"	1/2"	3/4"	100
<b>16207</b>	.257"	1/2"	1"	100

## Standard Insulating Bushings

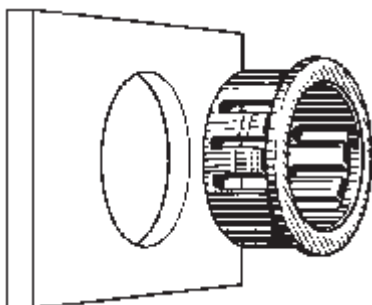

Nylon bushings designed to protect wires, cables, tubing, etc. from sharp, unfinished panel edges. Each size bushing employs multiple lock features to positively snap into panels ranging from 1/32" to 1/8" thickness. Available in both black and white nylon.

Auveco Part No.		Dimensions			Panel Hole Dia.	Unit Pkg.
Black Nylon	White Nylon	Inside Dia.	Head Dia.	Thick-ness		
<b>16086*</b>	· · ·	1/8"	5/16"	5/16"	1/4"	50
<b>16087</b>	<b>16099</b>	1/4"	15/32"	13/32"	3/8"	50
<b>16088</b>	· · ·	3/8"	37/64"	13/32"	1/2"	50
<b>16089</b>	· · ·	7/16"	21/32"	13/32"	9/16"	50
<b>16090</b>	· · ·	1/2"	23/32"	13/32"	5/8"	50
<b>16091</b>	<b>16103</b>	5/8"	27/32"	13/32"	3/4"	50
<b>16092</b>		11/16"	61/64"	29/64"	7/8"	50
<b>16093</b>		3/4"	1-1/8"	29/64"	1"	50
<b>16094</b>	· · ·	15/16"	1-7/32"	29/64"	1-3/32"	50
<b>16095</b>	<b>16107</b>	15/16"	1-23/64"	29/64"	1-1/4"	50
<b>16096</b>	<b>16108</b>	1-5/16"	1-39/64"	29/64"	1-1/2"	50
<b>16097</b>	<b>16109</b>	1-5/8"	2-1/8"	29/64"	2"	25

\*Maximum panel thickness is 1/16" rather than 1/8"



## All-Fit Adjustable Bushings

Black nylon "ALL-FIT" Adjustable Bushings are designed to protect wire, cable, tubing or irregular shaped items from sharp, unfinished edges. The specially designed resilient multiple supports absorb shock and vibration, and adjust to accept various diameters and shapes. The ALL-FIT Bushing is equipped with multiple locks to positively snap in panel thicknesses ranging from 1/32" to 1/8"

Auveco Part No.	Panel Hole Dia.	Bushings Dimensions			Unit Pkg.
		Head Dia.	Thick-ness	Max. I.D.	
<b>16564</b>	5/8"	23/32"	13/32"	7/16"	50
<b>16565</b>	3/4"	55/64"	25/64"	1/2"	50
<b>16567</b>	7/8"	15/16"	29/64"	9/16"	50
<b>16568</b>	1"	1-1/16"	29/64"	3/4"	50
<b>16569</b>	1-3/32"	1-5/32"	29/64"	13/16"	50

**MISCELLANEOUS ITEMS**

**KNOBS**

Black Thermoplastic Material • Zinc Plated Steel Studs & Inserts



Auveco Part No.	Internal Thread Size	Head O.D.	Unit Pkg.
<b>18958</b>	5/16"-18	1-3/4"	5



Auveco Part No.	Thread Size	Stud Length	Head O.D.	Unit Pkg.
<b>18959</b>	1/4"-20	1"	1-3/4"	5
<b>18960</b>	5/16"-18	1-1/2"	1-3/4"	3



Auveco Part No.	Internal Thread Size	Head Size	Unit Pkg.
<b>18961</b>	1/4"-20	11/16" x 2"	5
<b>18962</b>	5/16"-18	11/16" x 2"	5



Auveco Part No.	Thread Size	Stud Length	Head Size	Unit Pkg.
<b>18965</b>	5/16"-18	1-1/2"	11/16" x 2"	3



Auveco Part No.	Thread Size	Stud Length	Wing Span	Unit Pkg.
<b>18969</b>	1/4"-20	1/2"	1-3/4"	5
<b>18970</b>	5/16"-18	1-1/2"	1-3/4"	5

# MISCELLANEOUS ITEMS

**Sec. 27**

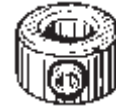
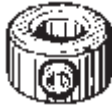

## Shaft Collars

Precision machined from cold finished steel. Equipped with cup point socket set screws. Zinc plated finish.

Auveco Part No.	Bore (I.D.)	O.D.	Width	Set Screw Size	Unit Pkg.
<b>15837</b>	1/4"	1/2"	5/16"	#10 x 1/8"	5
<b>15838</b>	3/8"	3/4"	3/8"	1/4" x 3/16"	5
<b>15839</b>	1/2"	1"	7/16"	1/4" x 1/4"	5
<b>15840</b>	5/8"	1-1/8"	1/2"	5/16" x 1/4"	5
<b>15841</b>	3/4"	1-1/4"	9/16"	5/16" x 1/4"	5
<b>15843</b>	1"	1-5/8"	5/8"	5/16" x 5/16"	2
<b>15844</b>	1-1/4"	2"	11/16"	3/8" x 3/8"	2

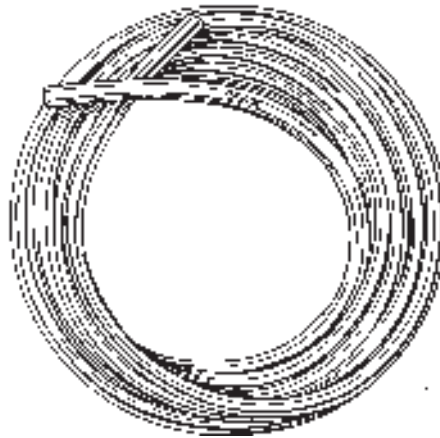

## Clear Flexible Vinyl (PVC) Tubing

Our tubing has a broad range of chemical resistance to acids, alkalis and solvents. It's ideal for use in industrial air pressure line applications, in the food industry (FDA approved), for potable water, and for various gases and chemicals. Not For Use With Gasoline.

Auveco Part No.	I.D.	O.D.	Wall Thickness	*Maximum Suggested Working Pressure (PSI @ 70° F)	Unit Package Quantity
<b>14801</b>	1/8"	1/4"	1/16"	59	100 Ft.
<b>14802</b>	3/16"	5/16"	1/16"	51	100 Ft.
<b>14803</b>	1/4"	3/8"	1/16"	51	100 Ft.
<b>14804</b>	5/16"	7/16"	1/16"	48	100 Ft.
<b>14805</b>	3/8"	1/2"	1/16"	41	100 Ft.
<b>14806</b>	3/8"	5/8"	1/8"	55	100 Ft.
<b>14807</b>	1/2"	5/8"	1/16"	28	100 Ft.
<b>14808</b>	1/2"	3/4"	1/8"	41	100 Ft.

\*We recommend verification by testing of the size and material to be used.

**Pushnut Fasteners  
(Axle Caps)**

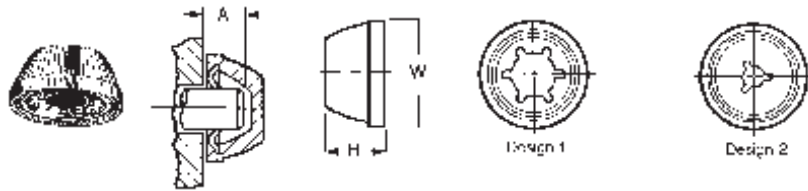

Cover Color - Black

Cover Material - Plastic

- Caps self-align on shafts
- Low push-on force, high retention
- Fast installation

Auveco Part No.	Unit Pkg.	Shaft Dia.	Cap O.D. W	Height Overall H	Min. shaft Extension A	Steel Thickness	Tooth Design	Min. Push-on Force	Min. Holding Strength
<b>14178</b>	50	3/16"	.656	.344	.150	.012	2	35	220
<b>14181</b>	50	3/8"	.835	.440	.175	.015	1	85	700
<b>16605</b>	15	3/4"	1.300	.645	.200	.018	1	95	1200

**Washer Cap Type Pushnut Fasteners**

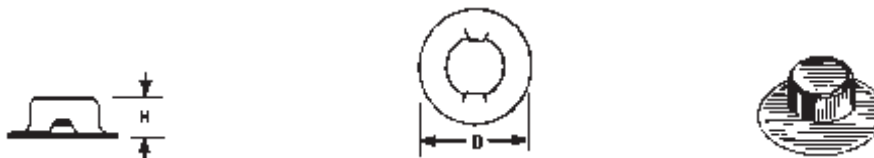

Finish - Zinc

Auveco Part No.	Unit Pkg.	Dimensions				Stud Diameter (In.)	Performance Pounds	
		Steel Thickness (In.)	Height H (In.)	Cap Dia. (In.)	Washer Dia. D (In.)		Push-On Force	Min. Holding Strength
<b>*14169</b>	100	.015	.202	.220	1/2	3/16(.188)	30	220
<b>14170</b>	100	.018	.205	.289	1/2	1/4(.250)	65	280
<b>14171</b>	100	.020	.236	.358	5/8	5/16(.312)	90	460
<b>**8719</b>	100	.020	.234	.419	11/16	3/8(.375)	70	380
<b>14172</b>	100	.025	.270	.431	3/4	3/8(.375)	90	700
<b>14173</b>	100	.030	.328	.504	7/8	7/16(.438)	150	960
<b>8665</b>	100	.030	.328	.567	15/16	1/2(.500)	150	800
<b>14174</b>	50	.031	.413	.693	1-3/16	5/8(.625)	230	1500

\*Zinc/Brite Chromate

\*\*Nickel Plated



**MISCELLANEOUS ITEMS**

**Push-Pull Controls**

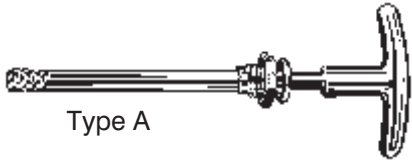

Type A

**20242**

Type A  
6' Long  
Chrome T-Handle  
Twist To Lock  
7/16"-20 Body Thread  
Wire Diameter: .072"

UNIT PACKAGE: 1

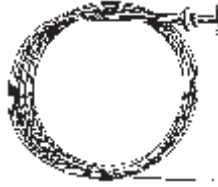

**14541**

Type B  
Choke Control  
5' Long  
Black Knob  
3/8"-24 Body Thread  
Wire Diameter: .047"

UNIT PACKAGE: 1



Type B

**20243**

Type B  
Choke Control  
8' Long  
Black Knob  
3/8"-24 Body Thread  
Wire Diameter: .054"

UNIT PACKAGE: 1

**Universal Small Engine/  
Lawnmower Push-Pull Control**

**14798**

6' Long  
Black Knob  
Wire Diameter: .054"  
Installation Instruction  
Sheet Included

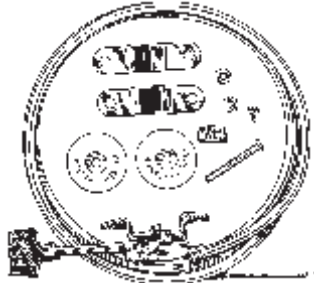

UNIT PACKAGE: 1

**Perforated Hanger Strap**  
Hot Rolled Galvanized Steel

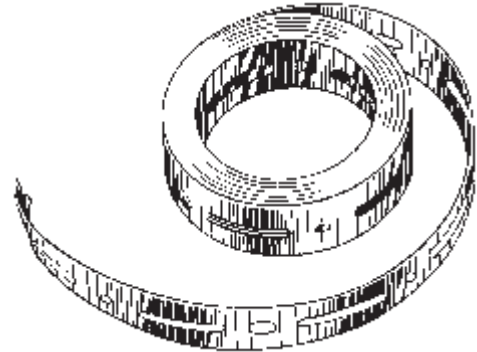

**14926**

28 Gauge  
3/4" Wide x 10 Ft.

UNIT PACKAGE: 1 ROLL

**Mechanics Wire**  
Soft Annealed, Black Steel Wire



**14927**

24 Gauge  
3/4" Wide x 10 Ft.

UNIT PACKAGE: 1 ROLL

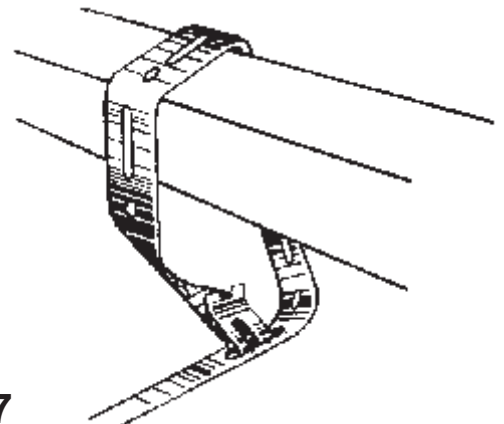

Auveco Part No.	Wire Gauge	Wire Length	Unit Pkg.
<b>14205</b>	18	2 LB. (332')	1 Spool
<b>14206</b>	16	2 LB. (192')	1 Spool
<b>14207</b>	18	5 LB. (831')	1 Spool
<b>14208</b>	16	5 LB. (480')	1 Spool

**MISCELLANEOUS ITEMS**

**Gas Pump Nozzles**

Rebuildable



**16294**

For Unleaded  
(No Lead) Gas  
Blue Scuff Guard  
1" Female Thread

UNIT PACKAGE: 1

**16296**

"Throwaway Nozzle"  
For Unleaded  
(No Lead) Gas  
Blue Scuff Guard  
3/4" Female Thread

UNIT PACKAGE: 1

**16297**

"Throwaway Nozzle"  
For Leaded Gas  
Red Scuff Guard  
3/4" Female Thread

UNIT PACKAGE: 1

**16298**

For Diesel Fuel  
Black Scuff Guard  
1" Female Thread

UNIT PACKAGE: 1

**Gas Pump Swivel**

C.A.R.B. Approved

Minimum Pressure Drop: Less Than 1PSI @ 10GPM



**16299**

3/4" Male x 3/4" Female

UNIT PACKAGE: 1



**Gas Pump Fail-Safe Breakaway Hose Coupling**

• C.A.R.B. Approved • 360 Degree Swivel • 1.5 Pound Pressure Drop @ 10GPM

**16303**

3/4" Diameter

UNIT PACKAGE: 1

**Expansion Plugs**

Zinc Plated



Auveco Part No.	Size	Type	Unit Pkg.
3937	1/2"	Concave	100
3938	5/8"	Concave	100
3939	3/4"	Concave	100
3941	15/16"	Concave	100
3942	1"	Concave	100
3944	1-1/8"	Concave	100
3945	1-3/16"	Concave	100
3946	1-1/4"	Concave	100
3947	1-3/8"	Concave	100
3949	1-5/8"	Concave	50
3950	1-3/4"	Concave	50
3952	7/16" O.S.	Cup	25
3953	1/2"	Cup	25
3956	5/8"	Cup	25
3957	3/4"	Cup	25
3958	7/8"	Cup	25
15212	15/16"	Cup	50
3960	1"	Cup	25
3961	1-1/8"	Cup	25

Auveco Part No.	Size	Type	Unit Pkg.
3962	1-7/32"	Cup	25
3963	1-1/4"	Cup	25
3964	1-3/8"	Cup	25
3965	1-1/2"	Cup	25
15213	1-1/2"	Shallow Cup	50
3966	1-5/8"	Cup	25
3967	1-3/4"	Cup	25
3968	1-7/8"	Cup	25
3969	1-15/16"	Cup	25
9322	1-49/64"	Shallow Cup	25
3970	1-61/64"	Cup	25
3971	2"	Cup	25
15211	2-3/32"	Shallow Cup	25

See Page 74 for Metric Expansion Plugs. For an Assortment of Expansion Plugs, See Kit No. 6067

## Battery Hold Down Bolts



**14461**

(Chry: 2534814)  
Plain

Battery Hold Down Bolt w/Nut  
Size: 1/4"-20 x 7"  
Thread Length: 2"

UNIT PACKAGE: 10



**8964**

(Ford: B5A-10756-B)  
Plain

Battery Hold Down Bolt w/Nut  
Size 5/16"-18 x 10"  
Thread Length 2-3/4"

UNIT PACKAGE: 10



**8971**

(Chry: 2074089)  
Plain

Inside Battery Hold Down Bolt w/Nut  
Size 1/4"-20 x 9"  
Thread Length 2-1/4"

UNIT PACKAGE: 10



**10643**

Plain

Battery Hold down Bolt w/Nut  
Size 5/16"-18 x 12"  
Thread Length 6"

UNIT PACKAGE: 10



**8963**

(GM: 3688699)  
Plain

Battery Hold Bolt w/Nut  
Size: 5/16"-18 x 8"  
Thread Length: 1"

UNIT PACKAGE: 10



**10644**

Plain

Battery Hold Down Bolt w/Nut  
Size: 3/8"-16 x 10"  
Thread Length: 3"

UNIT PACKAGE: 10

Please Order In  
Unit Package Quantities  
Not Number Of Pieces

Battery Terminals, Cable Lugs,  
Battery Cable And Battery Tools  
Are Listed On Pages 165 - 169.





**7914**

Double ended tool combines both left and right hand. Removes reveal mouldings on rubberless windshield jobs.  
GM

UNIT PACKAGE: 1

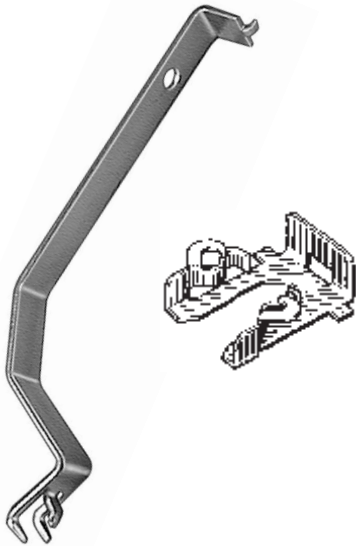

**Ford  
Headlight Retaining Clip  
(15940)**

**Removal Tool**

**19269**

Removes headlight clip 15940 without damaging it. Can also be used to install the clip.

UNIT PACKAGE: 1



**Prep Pen  
Spot Sanding Pen  
With Glass Fibers**

**Part No. 18335**

Now you can thoroughly clean rust, dirt or wax from any tight corner, crevice or hard to reach spot with 20,000 glass fibers in a pen point. The fibers are finer than human hair yet stronger than steel when it comes to cleaning power.

Sand paper can be too rigid to directly contact and clean the contours of inside edges. Thus conventional sanding only cleans the high spots. The Prep Pen's glass fibers can be extended out (by turning) to ensure even the smallest recesses get cleaned.

UNIT PACKAGE: 1

**Convertible  
Retaining Ring  
Pliers**

**For Internal and External  
Retaining Rings**

**7909**

Use With Auveco Retaining Rings:  
8675 To 8678 (External)  
8688 To 8697 (Internal)  
8700 To 8709 (External)  
10116 To 10121 (External)

UNIT PACKAGE: 1

**7910**

Use With Auveco Retaining Rings  
8679 To 8683 (External)  
8698 To 8699 (Internal)  
8710 To 8712 (External)  
10122 To 10129 (External)  
16743 To 16748 (External)

UNIT PACKAGE: 1

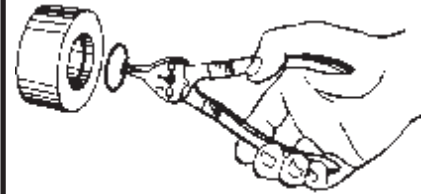

INTERNAL POSITION

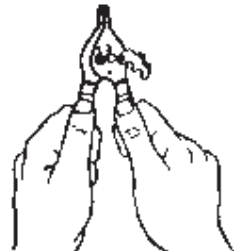
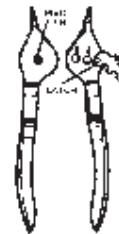

CHANGING PLIERS SETTING



EXTERNAL POSITION

**Trim Pad Removing Tool**

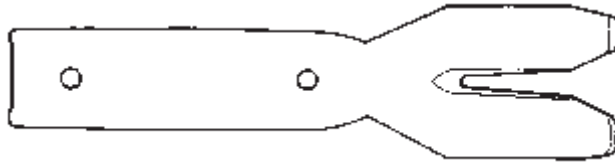

(Not Actual Size)

**7999**

The Trim Pad Removing Tool is the first tool designed specifically to pull out the plastic trim pad fasteners used on GM cars. It reaches under the trim panel, supports and grips the plastic fastener, and lifts it without damage to the fastener or to the trim pad backboard. The Trim Pad Removing Tool is made of heat treated, high carbon steel and will work equally well on metal fasteners.

UNIT PACKAGE: 1

Double Blade 3/16" Apart

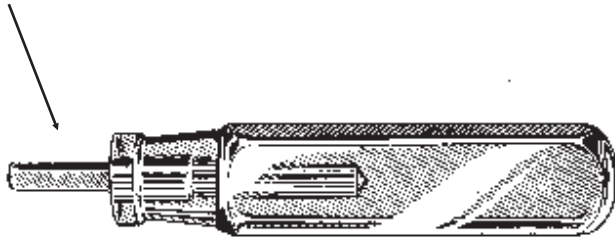

**14481**

Windshield Knife

This tool features a unique double blade action that is ideal for cutting out urethane around windshields. It features a 3/16" wide blade and a 4-5/8" long machined amber tenite handle.

UNIT PACKAGE: 1



**7657**

Hog Ring Plier:  
Straight Nose Spring Grip,  
holds rings in place for fast  
work.

UNIT PACKAGE: 1



**7660**

Hog Ring Cutters:  
Tough, Durable-Cuts on  
an angle

UNIT PACKAGE: 1

For use w/Auveco Pan'l Rivets



**12676**

Double End Drill Bit  
135° Split Point  
1/8" (.125") Dia.  
2" Length

UNIT PACKAGE: 5



Pan'l High Speed  
Twist Drills  
135° Split Point  
For use w/Auveco Pan'l Rivets

Auveco Part No.	Size	Unit Pkg.
<b>9316</b>	.125" (1/8")	12
<b>9317</b>	.1285" (1/8")	12



**7658**

Hog Ring Plier:  
Offset Angle Nose for close  
to floor non-removable  
cushions.

UNIT PACKAGE: 1

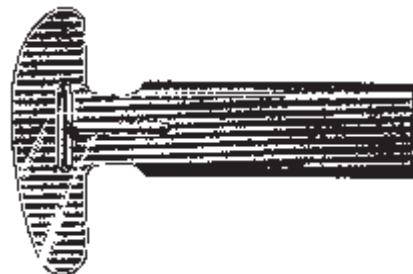

**7672**

Headliner Tool:  
Stuffs headlining in channel  
above doors. Stuffs  
upholstery, trim edges into  
tedious places. Blunt edge of  
blade cannot damage  
material. Easy to use around  
curves and near corners.

UNIT PACKAGE: 1

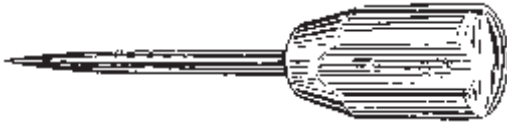

**13579**

Heavy Duty Scratch Awl  
Quality Steel 3-1/2" Blade with rugged plastic handle.

UNIT PACKAGE: 1



**15301**

Clip Removal Tool

The right tool for removing clips and retainers quickly and easily. Simply seat the tool on the shaft of the fastener and squeeze the handles together. Made of high carbon steel and heat treated for strength. Zinc plated with vinyl molded handle grips.

UNIT PACKAGE: 1

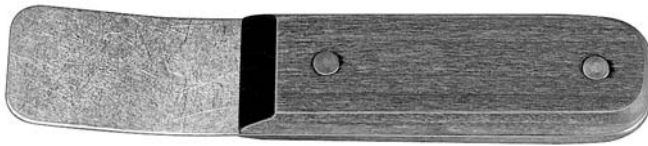

**13575**

For tucking Headlining and Upholstery around windows and above doors and other hard to reach places. A sturdy tool with a slightly curved blade that has finished edges and rounded corners. Comfortable wood handle with eyelet hole through one end.

UNIT PACKAGE: 1

**Auveco** PRODUCTS **Auveco Display Boards Are Great Selling Tools. Use Them To Help Boost Your Sales. Refer To The Color Pages At The Front Of The Catalog.**

**13572**

All Purpose Awl

The best awl is a varied-purpose tool. It assists in the installation of roof windows, windshield rubber and back glass. It is used to remove body clips, mouldings and for spring pulling and cotter pin extracting or for radiator hose removal. Great for hard to reach places.

Tempered end.

UNIT PACKAGE 1



**17088**

An all purpose awl with an extra long hook. Use to remove mouldings, body clips, windshield seals, cotter pins and radiator hoses. Made of tough spring steel, heat treated, tempered and plated. Features 4-7/8" long blade with 2" long hook. Overall length is 8".

UNIT PACKAGE: 1





**Pull Rods**

Repair quarter sections, doors, tops, etc., entirely from the outside! Super-tough Pull Rods were developed as the answer to repairing today's boxed-in cars. A must for metal station wagons and panel trucks.

This process of body repair is really fast-Drill Holes-Pull Out Damage-Fill Holes-Sand Flush-and you are ready to paint.

Pull Rods eliminate the removal and replacement of headliners, upholstery, inner panels, etc. They enable you to direct your time and effort at repairing the job-not trying to get at it. You work exclusively outside the car!

**Hole Filling**

No need to be afraid of drilling holes in a good-looking car. They are quickly and permanently filled with a soldering iron.



**AV-200-1**

Formed Shank Pull Rod:

UNIT PACKAGE: 1



**AV-200-2**

Straight Shank Pull Rod:

UNIT PACKAGE: 1



Hexagon Shank Magnetic Chuck for Driving Screws Into Metal with an Electric Drill.

Auveco Part No.	Hex Head Shank	Screw Size	Unit Pkg.
<b>7767</b>	1/4"	1/4"	1
<b>11761</b>	1/4"	5/16"	1
<b>11762</b>	1/4"	3/8"	1



**Hex Keys**

Auveco Part No.	Socket Screw Size	Wrench Size	Unit Pkg.
<b>5414</b>	1/16"	1/32"	10
<b>5415</b>	No. 8	7/64"	10
<b>5417</b>	1/4"	1/8"	10

**Metric Hex Keys Plain Finish**



Use w/  
DIN 912 & DIN 7991

Auveco Part No.	Hex Size	For Screw Size	Unit Pkg.
<b>7965</b>	3mm	4mm	10
<b>7969</b>	8mm	10mm	10

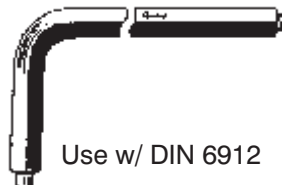

Use w/ DIN 6912

Auveco Part No.	Hex Size	For Screw Size	Unit Pkg.
<b>7975</b>	10mm	12mm	10



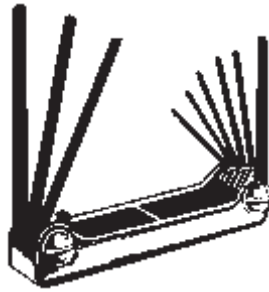

**Fold-Up Hex Key Set**

Auveco Part No.	Size	Keys	System
<b>7976</b>	Small .050" thru 5/32"	8	U.S.
<b>7977</b>	Medium 5/64" thru 1/4"	9	U.S.
<b>7978</b>	Large Extra Long 3/16" thru 3/8"	5	U.S.
<b>7980</b>	Large Extra Long 4mm thru 10mm	5	Metric

UNIT PACKAGE: 1



**Set No. 12526**  
Torx® Power Drive Bit Set  
1" Shank

Parts Included 1 each:

Auveco Part No.	Size
<b>12472</b>	T-10
<b>11949</b>	T-15
<b>11950</b>	T-20
<b>12103</b>	T-25
<b>12104</b>	T-30
<b>12105</b>	T-40



**Torx® Key**

Auveco Part No.	For Size	Screw Dia.	Unit Pkg.
<b>12481</b>	T-25	10	2

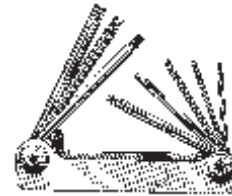

**12753**

Torx® Key Set

Sizes: T9, T10, T15, T20, T25, T27, T30, T40  
UNIT PACKAGE: 1



**Torx® Power Drive Bits**  
1" Shank

Auveco Part No.	Bit Size	Hex Size	For Screw Size	Unit Pkg.
<b>12472</b>	T-10	1/4"	No.4	1
<b>11949</b>	T-15	1/4"	No.6	1
<b>11950</b>	T-20	1/4"	No.8	1
<b>12103</b>	T-25	1/4"	No.10	1
<b>14913</b>	T-27	1/4"	No.12, 1/4"	1
<b>12104</b>	T-30	1/4"	1/4"	1
<b>12105</b>	T-40	1/4"	5/16"	1
<b>14914*</b>	T-45	5/16"	3/8", 7/16"	1
<b>14915*</b>	T-50	5/16"	7/16", 1/2"	1
<b>14916*</b>	T-55	5/16"	1/2", 9/16", 5/8"	1

\*1-1/4" Shank



**Torx® Power Drive Bits**  
2" Shank

Auveco Part No.	Size	For Screw Dia.	Unit Pkg.
<b>12474</b>	T-15	6	1
<b>12475</b>	T-20	8	1
<b>12477</b>	T-30	1/4"	1

**Torx® Tool Selection Chart**

Auveco Part No.	Size	Round Washer Head	Pan Head	Pan Head Struck Slot	Flat Head	100 Flat Head	Hex Head	Hex Washer Head	Truss Head	Fillister Head	Oval Head
		Screw Size	Screw Size	Screw Size	Screw Size	Screw Size	Screw Size	Screw Size	Screw Size	Screw Size	Screw Size
<b>12472</b>	T-10	4 & 5	4 & 5	4 & 5	5 & 6	6	4 & 5	5	6	4 & 5	5
<b>11949</b>	T-15	6	6	6	8	8	6	6	8	6	6
<b>11950</b>	T-20	8	8	8	10	10	8	8	10	8	8
<b>12103</b>	T-25	10	10	10	12	x	10	10	12	10	10
<b>14913</b>	T-27	12	12	12	1/4	x	12	12	1/4	12	12
<b>12104</b>	T-30	1/4	1/4	1/4		1/4	1/4	1/4		1/4	1/4
<b>12105</b>	T-40		5/16	5/16	5/16&3/8	5/16	5/16	5/16	5/16	5/16	5/16
<b>14914</b>	T-45		3/8	3/8		3/8	3/8	3/8	3/8&7/16	3/8	3/8
<b>14915</b>	T-50		7/16	7/16	7/16&1/2	7/16			1/2	7/16	7/16&1/2
<b>14916</b>	T-55		1/2	1/2	9/16&5/8	1/2			9/16&5/8	1/2&9/16	9/16&5/8
<b>•••••</b>	T-60				3/4				3/4	5/8	3/4

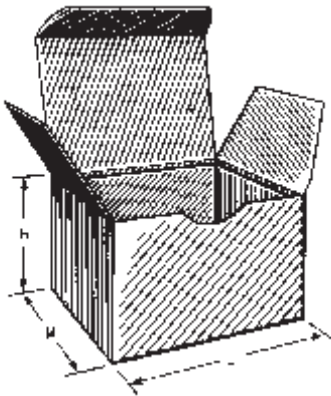

**Plain Kraft Boxes  
No Imprinting**

Plain brown kraft versions of four popular sizes of Auveco boxes for packaging small parts. Each box is made of .028" thick chipboard. The full-flap, hardware bottom with locking side tabs provides for a full-strength, spill-proof box. Refer to the chart below for the quantity of boxes per unit package carton.

Auveco Part No.	Length (L)	Width (W)	Height	Boxes Per Carton	Weight Per Carton (lbs.)
<b>0-Boxes</b>	2-3/4"	1-1/2"	1-3/4"	1050	30
<b>1-Boxes</b>	2-3/4"	2-1/4"	1-7/8"	800	33
<b>2-Boxes</b>	3-3/8"	2-7/8"	2"	375	23
<b>3-Boxes</b>	3-1/2"	2-7/8"	2-7/8"	250	19
<b>4-Boxes</b>	4-3/4"	2-3/4"	3"	250	21
<b>7-SBoxes</b>	4-1/4"	3"	6-1/2"	425	55

UNIT PACKAGE: 1 CARTON

# TOOLS

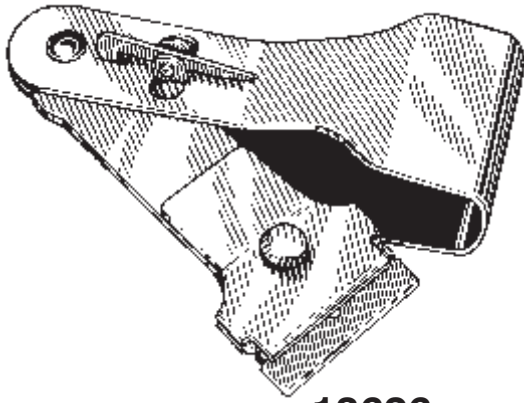

**13626**

A unique retractable scraper that takes the aggravation out of getting old stickers off car windshields and paint blotches off windows. The scraper is 7-7/8" when fully open and locked in position. The razor blade holder tilts the blade to give a better angle of attack in tight corners. The blade can be folded 180 degrees into the handle and locked when not in use, permitting it to be kept in a tool box safely. The blade can be replaced when worn out and the entire tool is compact and durable as well as economical.

UNIT PACKAGE: 1



**13625**

Single Edge Razor Blades  
For use w/13626 and  
General Purpose

UNIT PACKAGE: 100

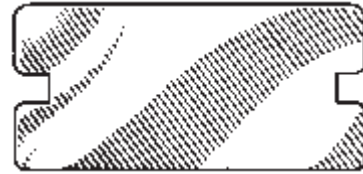

**14543**  
**14575**  
**14576**

UNIT PACKAGE: 25  
UNIT PACKAGE: 100  
UNIT PACKAGE: 1,000

Now you can safely remove stickers from plastic-coated windshields without risk of scratching or cutting the windshield.

Made of polypropylene, these blades are also ideal for scraping many other surfaces in automotive, industrial and home applications. Use with tool 13626.



**13578**

Auto Trimmers & Upholsterers  
Combination Knife

Made of finest steel with both hook and pointed blade used for ripping seams. Cuts auto and home carpeting, vinyl, plastic and rubber.

Beechwood handle contoured to fit hand. A handy professional tool.

UNIT PACKAGE: 1

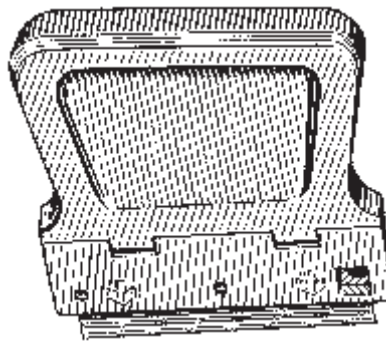

**Mini Plastic Scraper  
With Razor Blade**

**17978**

Mini Scraper with razor sharp edge that cuts or scrapes paint, stickers, cardboard, string, etc. Flip a latch and turn the razor blade over to safely store the scraper

UNIT PACKAGE: 5

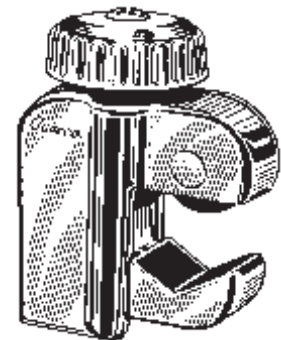

**13623**

For cutting copper tubing  
in close quarters  
Cuts tubing 1/8" to 5/8" O.D.

UNIT PACKAGE: 1

**TOOLS**

**Professional Drill-Out® Broken Bolt Extractor Kit**

Take The Frustration Out Of Removing Broken Bolts.  
Made In U.S.A.



- Revolutionary new method for removing broken bolts
- Incredible improvement over traditional methods of extracting broken bolts
- Easy, timesaving operation
- Fast and reusable
- Self-centering tip

**Part No. 17093**

For grade 5 and grade 8 bolts in sizes: 1/4" (6mm), 5/16" (8mm), 3/8" (10mm) & 1/2" (12mm)

UNIT PACKAGE: 1

**Replacement Extractor Tools**



Auveco Part No.	Drill Size
<b>20537</b>	1/4" (6mm)
<b>20538</b>	5/16" (8mm)
<b>20539</b>	3/8" (10mm)
<b>20540</b>	1/2" (12mm)

The Drill-Out Broken Bolt Extractor is excellent for removing broken bolts and studs without damaging the threads in the hole. The drill body is manufactured using the finest quality hi-speed steel. The collet is produced from hot die steel, using the finest steel of its type. All Drill-Out Broken Bolt Extractors are made with a precision ground 118° left hand cutting self-centering point, and are heat treated for toughness.

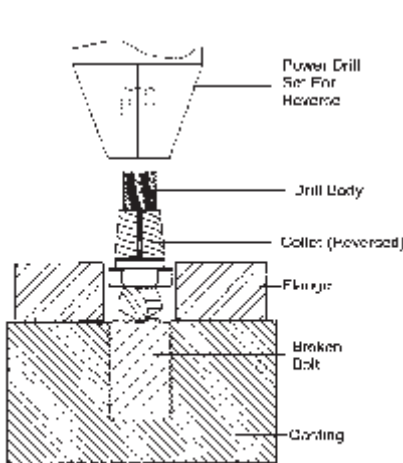

FIG. 1

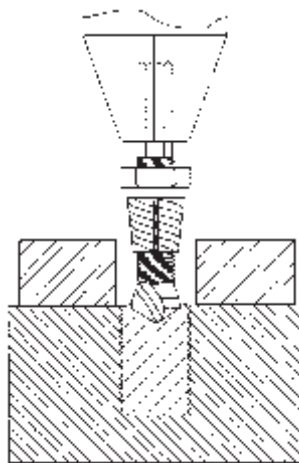

FIG. 2

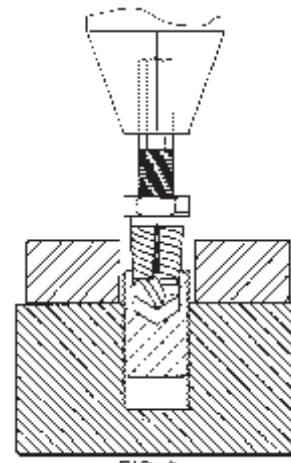

FIG. 3

**Fast & Easy To Use.**

Always Use Protective Eye Wear When Drilling.

1. Place the Drill-Out tool into an electric drill and set for reverse operation. Move the collet up to the chuck. Note: when the bolt is broken below a flange attached to a casting, reverse the collet as in (Fig. 1.)
2. Making sure the drill is set in reverse, place the tip of the Drill-Out on the center of the broken bolt and begin drilling. Do not allow the collet to move down towards the tip while drilling. If so, thread the collet back towards the chuck. Drill just deep enough to start a hole (approximately 1/16").
3. Make sure the hole is started on center of the bolt. If you reversed the collet in step 1, change it back at this time. Continue drilling. Stop just before you reach the front of the collet. Do not let the collet touch the end of the bolt. (Fig.2)
4. Remove the Drill-Out tool from the broken bolt. Move the collet down towards the tip so that 2 threads are showing. Bring drill up to speed and plunge it into the hole. The collet automatically engages and extracts the broken bolt. (Fig.3)

Detailed Instructions Included in The Kit

# TOOLS

## Moulding Cutting Tool



**Part No. 15748**

A professional quality tool that cuts with absolute accuracy every time to give a clean, accurate and precise edge. The **15748** tool features a replaceable razor-sharp blade cutting against a plastic anvil which is also replaceable. Excellent for cutting rubber/plastic moulding (up to 3-1/2"), weatherstrip, carpeting and most flexible materials. The tool measures 10" overall and the handles are vinyl coated.

UNIT PACKAGE: 1



**15750**

Replacement Cutting Blades

UNIT PACKAGE: 2

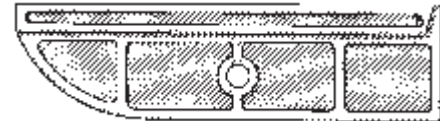

**15751**

Replacement Anvil

UNIT PACKAGE: 1

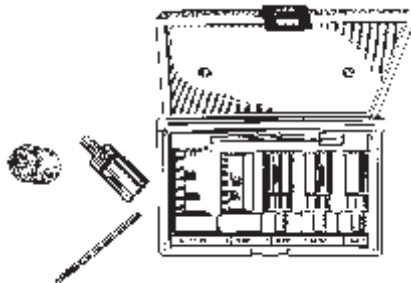

**14477**

Hole Saw Kit

The five most popular hole saw sizes plus one pilot drill packaged in a high impact resistant plastic case. The kit contains:

Sizes	7/8"(22mm)	1-1/4"(32mm)
	1"(25mm)	1-1/2"(38mm)
	1-1/8"(29mm)	1/4" Pilot Drill

Each saw is constructed with a high speed M3 cutting edge welded to a resilient alloy back. The saws will cut a 1-3/8" deep hole in any material that can be cut with a hacksaw blade—from wood and plastics to harder materials such as stainless steel. The patented feature of our hole saws is an arbor that is permanently attached to every unit.

For best results, use a 1/2" drill, chucking directly to the stem. 1/4" and 3/8" drills can chuck directly to the stem of the pilot drill (not recommended for sawing holes over 1").

UNIT PACKAGE: 1

# Sec. 28

# Aluminum Oxide Resin Bonded Cut-Off Wheels

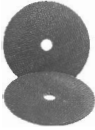

Designed for steel cutting use only. Never use these wheels for any other applications.  
Never Use On Fiberglass!

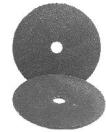

Auveco Part No		SPECIFICATIONS				
Unit Pkg. 10	Unit Pkg. 25	Dia.	Thickness	Arbor	Grit	RPM
19688	19687	3"	1/16"	3/8"	54	25,000
19690	19689	3"	1/32"	3/8"	54	25,000
19692	19691	3"	1/16"	1/4"	54	25,000
19694	19693	3"	1/32"	1/4"	54	25,000
19696	19695	3"	1/8"	1/4"	46	25,000
19698	19697	3"	1/8"	3/8"	46	25,000
19700	19699	4"	3/32"	5/8"	46	15,300
19702	19701	4"	1/32"	3/8"	60	21,000
19704	19703	4"	1/32"	5/8"	60	21,000
19706	19705	4"	1/16"	3/8"	54	21,000
19708	19707	4"	1/8"	3/8"	46	15,300
•••••	19709	4"	1/16"	7/8"	46	21,000

## General Purpose Depressed Center Wheels

TYPE 27

Standard Shape

The most popular Raised Hub wheel for grinding and blending



### CAUTION!

Never Use A Wheel That Has Been Dropped

- Always Wear Full Face Protection When Grinding
- Use A Guard Covering 50% Or More Of Wheel Diameter



Auveco Part No		SPECIFICATIONS				
Unit Pkg. 10	Unit Pkg. 25	Dia.	Width	Arbor	Grit	RPM
19712	19711	4"	1/4"	5/8"	36	13,700
19714	19713	4-1/2"	1/4"	7/8"	24	11,900

## Cut-Off Wheel Mandrels (Arbors For Air Grinders)



**19715**  
Zinc

Mandrel With  
3/8" Shoulder Screw

UNIT PKG: 1

Not Actual Size



**19716**  
Zinc

Mandrel With  
1/4" & 3/8" Shoulder Screws

UNIT PKG: 1

**TOOLS**  
Gauges

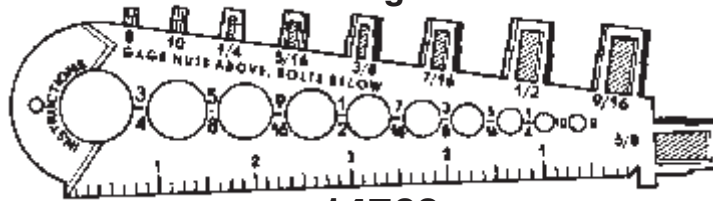

**14769**

U.S.S. & S.A.E. Plastic Gauge

UNIT PACKAGE: 1

Just push the bolts through the holes to find the bolt diameter. The length gauge measures "regular" heads from the left end and countersunk heads from the notch at the right end. Nuts drop on the plugs along the top edge of the gauge. S.A.E. fine thread nuts fit to the base of the plugs, U.S.S. coarse thread nuts fit half-way.

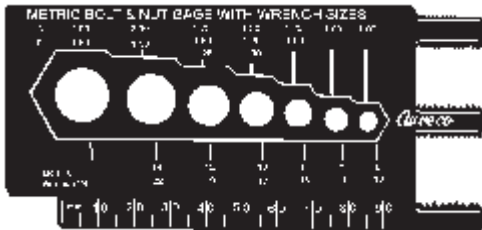

**14770**

Metric Bolt & Nut Plastic Gauge

Determine the diameter of bolts by pushing them thru the holes. Measure the hex head of bolts & screws or the "across the flat" dimension of hex nuts in the recesses around the holes (listed as wrench size). Right-hand side of tool measures thread pitch (1.00, 1.50, 1.75 & 2.00).

U.S.S. Bolt	U.S.S. Nut	S.A.E. Bolt	S.A.E. Nut	Wrench Size	Tap Drill	Clearance Drill
1/8"	1/8"	1/8"	1/8"	1/8"	.073	.086
1/4"	1/4"	1/4"	1/4"	1/4"	.112	.125
3/8"	3/8"	3/8"	3/8"	3/8"	.154	.164
1/2"	1/2"	1/2"	1/2"	1/2"	.190	.216
5/8"	5/8"	5/8"	5/8"	5/8"	.250	.312

**14771**

Screw Chek'r Plastic Gauge

Identifies all machine screws, U.S.S. & S.A.E. bolts, wood screws, self-tapping screws, standard size rivets and common cotter pins up to 5/16" diameter. Also includes clearance drill size, tap drill size and tap series information. Instructions included.

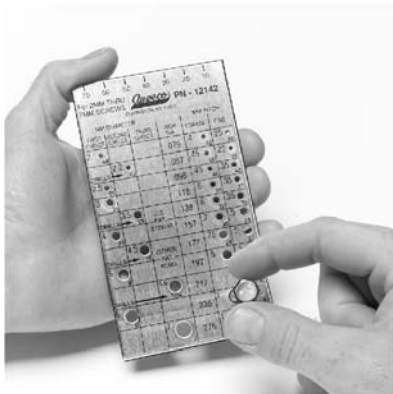

**12142**

For ISO Metric Screws From 2mm thru 7mm

UNIT PACKAGE: 1

**Metric Screw Checker Metal Gauges**

Tells

Length in millimeters & inches

Tap series

I.S.O. preference rating

Size (in millimeters)

Pitch (in millimeters)

Clearance drill size

Tap Drill Size

Basic diameter (in inches)

**12143**

For ISO Metric Screws From 8mm thru 14mm

UNIT PACKAGE: 1

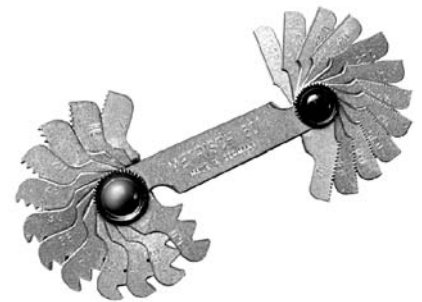

**7955**

Metric Screw Pitch Metal Gauge:  
Pitch Capacity 0.25 to 6mm  
24 Blades

UNIT PACKAGE: 1

**Heavy Duty Industrial Flashlights**

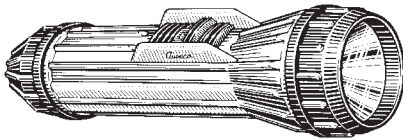

Type 1

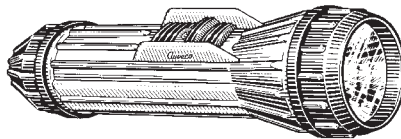

Type 2



Type 3

Heavy duty construction for a long life in a tough industrial environment. Water, shock and corrosion resistant. Each flashlight requires two D cell batteries (not included).

**16166**

Type 1  
Parabolic reflector for spot light work with penetrating focused beam. Yellow with black ends. Includes a spare bulb. 8-1/2" Long.

**16167**

Type 2  
Magna-Beam flood reflector covers 10 times the normal area. Yellow with black ends. Includes a spare bulb. 8-1/2" Long.

**16168**

Type 3  
Fixed magnet plus Magna-Beam reflector which covers 10 times the normal area. Yellow with black ends. Includes a spare bulb. 8-1/2" Long.

**16169**

Type 2  
Contains super-bright krypton bulb. Burns 70% brighter than ordinary bulb. Magna-Beam flood reflector covers 10 times the normal area. Yellow with blue ends 8-1/2" Long.

UNIT PACKAGE: 1

UNIT PACKAGE: 1

UNIT PACKAGE: 1

UNIT PACKAGE: 1

**“Stubby” Fluorescent Work Light**

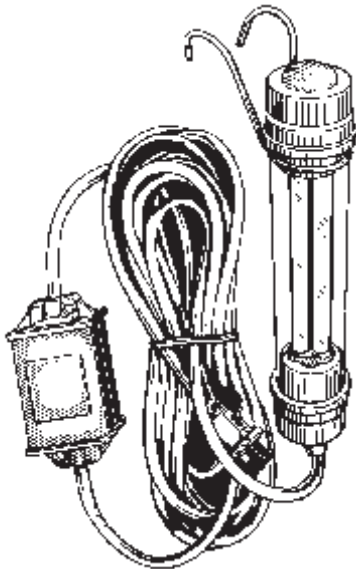

**18245**

With a 2" diameter and 9-3/4" length the “Stubby” is a compact, bright work light that provides 13 watts of high intensity light. The 13 watt light bulb is equivalent in light output to a 100 watt incandescent bulb while being four times more efficient and lasting up to ten times longer (10,000 hours).

Protected on-off switch can be operated by depressing domed end of the light. Oil resistant type SJTOW-A 25 foot cord set is specially designed to stay flexible in cold weather.

UNIT PACKAGE: 1

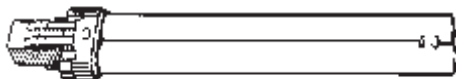

**18246**

Rough service replacement fluorescent light bulb for 18245 “Stubby” work light. 13 watt, 110 volts.

UNIT PACKAGE: 1



**TOOLS**  
**Tape Slitter & Accessories**

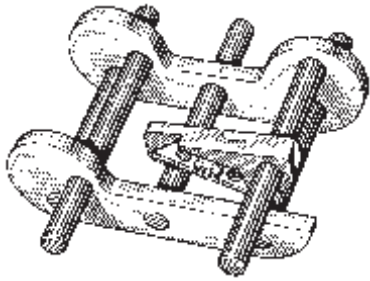

**16170**

Hand-held tape slitter cuts single or multiple strips of pin striping tape. Provides an accurate straight cut every time. Adjustable for tape widths from 1/8" to 2". Comes with one blade and holder. You can add additional blades and holders for cutting multiple strips.

UNIT PACKAGE: 1

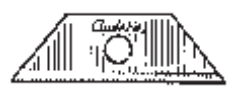

**16171**

Replacement Cutting Blades

UNIT PACKAGE: 10

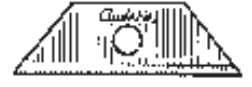

**16172**

Replacement Cutting Blades & Blade Holders

UNIT PACKAGE: 3 Each

**Wire Bending Tool**  
 For Truck Seat Springs

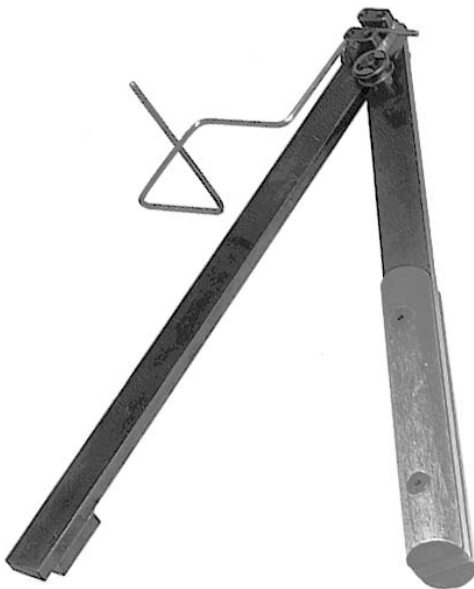

**16894**

A tough tool that makes difficult wire repairs easy. You can bend the ends of no sags, edgewise and foam springs right on the spot, making offsets where you need them. Can be readily mounted in a vise for duplicating complex repetitive wire bends. Constructed of heat-hardened steel for long life.

UNIT PACKAGE: 1

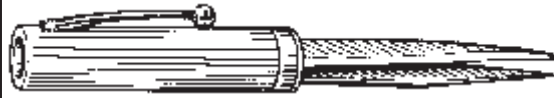

**16029**

Pinpoint Tip Tweezers

Now you can remove bugs, hair, lint or any other airborne debris from newly painted surfaces, with pinpoint accuracy and without disturbing the finish.

The stainless steel tweezers are non-corrosive, non-magnetic and they won't tarnish. The handy pen design slips into a painter's pocket until needed. Overall length: 5-3/16".

UNIT PACKAGE: 1



**Safelight Igniter**  
**20533**

The new patented Safelight Igniter is the simple but durable alternative to the traditional flint striker for lighting hand-held torches. It replaces flint strikers forever!!!

- \*Outlasts flint strikers by thousand of strikes
- \*Doesn't require flint or batteries
- \*Functions when wet
- \*Completely safe
- \*Saves time and money
- \*Patented design

UNIT PACKAGE: 1

# TOOLS

## Caulking Guns

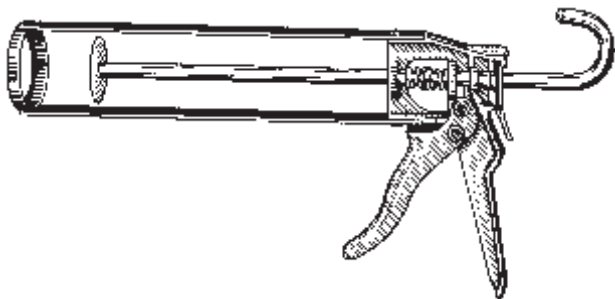

### Part No. 16667

UNIT PACKAGE: 1

This professional gun is fabricated from die cast alloy and steel, both riveted and welded for maximum strength. It features a smooth hexagonal drive rod and precision catch plate for effortless action. The handle and trigger are designed for comfortable operation over a long period of use. Corrosion resistant orange epoxy powder coated.

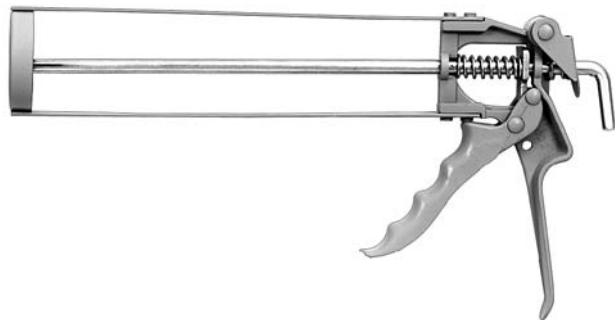

### 19092

UNIT PACKAGE: 1

This economical gun is fabricated from die cast alloy and steel, both riveted and welded for maximum strength. It features a smooth round drive rod and precision catch plate for effortless action. The handle and trigger are designed for comfortable operation over a long period of use. Corrosion resistant orange epoxy powder coated.

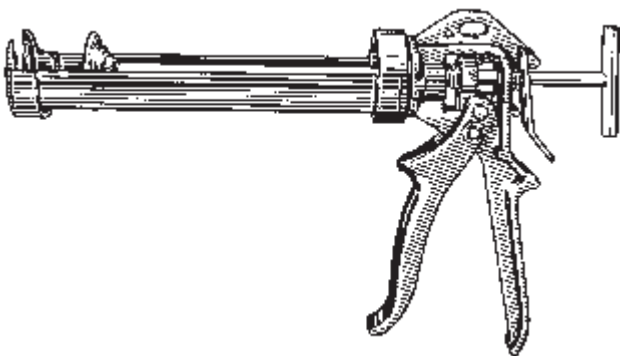

### Part No. 17123

UNIT PACKAGE: 1

This deluxe heavy duty caulking gun ensures operator comfort and efficiency of use. It has a die-cast alloy, profiled hand grip for strength and lightness, which is contoured for use by all hand sizes and allows the use of smooth, full strokes.

The advanced design of the drive mechanism has a patented catch plate system. Combined with use of a hardened steel drive rod, this prevents notching and scoring of the rod.



### 19093

UNIT PACKAGE: 1

This economical **heavy duty** caulking gun ensures operator comfort and efficiency of use. It has a die-cast alloy, profiled hand grip for strength and lightness, which is contoured for use by all hand sizes and allows the use of smooth, full strokes. The hardened steel drive rod, prevents notching and scoring of the rod.



### 13577

Revolving Punch

A fine quality pressed frame revolving punch with drive tubes. All tubes are heat treated to give long wear. Fully nickel plated.

Furnished with tube sizes 0,1,2, 3, 5, and 7 (Hole sizes 5/64", 3/32", 7/64", 1/8", 5/32", and 3/16"). Length 8"

UNIT PACKAGE: 1

# TOOLS Grease Guns

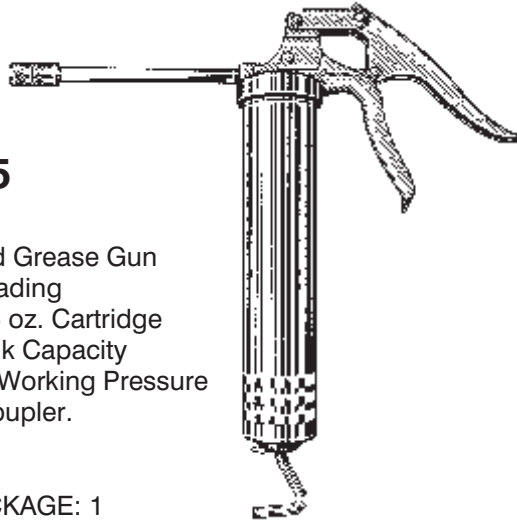

**16275**

One-Hand Grease Gun  
3-Way Loading  
Uses 14.5 oz. Cartridge  
16 oz. Bulk Capacity  
2500 PSI Working Pressure  
3 Claw Coupler.  
Blue

UNIT PACKAGE: 1

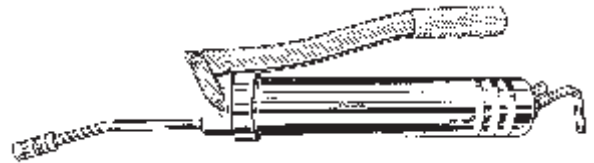

**16276**

Heavy Duty Grease Gun  
3-Way Loading  
Uses 14.5 oz. Cartridge  
16 oz. Bulk Capacity  
10,000 PSI Working Pressure  
3 Claw Coupler  
Blue With Orange Vinyl Grip

UNIT PACKAGE: 1

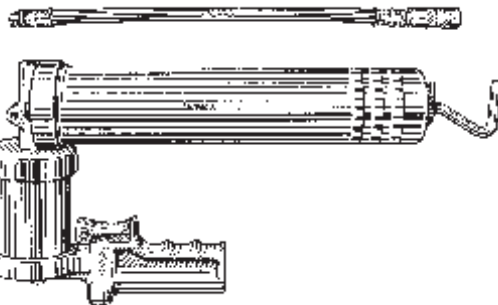

**16278**

Air Operated Grease Gun  
Pressure Ratio 50:1  
Required Air Pressure: 30-120 PSI.  
Suggested Working Air pressure: 90 PSI  
3-Way Loading  
Use 14.5 oz. Cartridge  
16 oz. Bulk Capacity  
4 Claw Coupler  
Gray

UNIT PACKAGE: 1

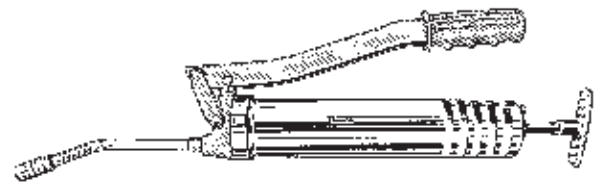

**16277**

Professional Grease Gun  
Delivers Grease At Various  
Lever Openings.  
3-Way Loading  
Uses 14.5 oz. Cartridge  
16 oz. Bulk Capacity  
Variable Pressure  
4 Claw Coupler  
Zinc With Black Rubber Grip

UNIT PACKAGE: 1

## Grease Gun Hoses

1/8" NPT Male Fittings

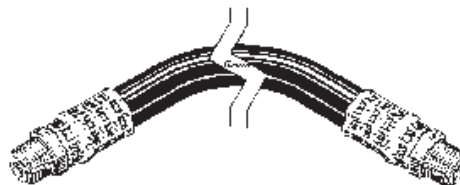

**15691**

12"  
3000 PSI

UNIT PKG: 1

**15692**

18"  
3000 PSI

UNIT PKG: 1

**16279**

12"  
5800 PSI

UNIT PKG: 1

**16280**

18"  
5800 PSI

UNIT PKG: 1

**TOOLS**

**Barrel Pump & Suction Gun**



**16283**

**Barrel Pump**  
 Designed to handle fluids from drums up to 55 gallons. Delivers 1-1/2" pints per 36" stroke. 2" bung nut. Can Be used for lubricants, chemicals and automotive additives (except transmission oil). Steel construction with sturdy curved polyethylene spout resistant to oil, acid and gasoline.

UNIT PACKAGE: 1



**16285**

**Barrel Pump Hose**  
 40" polyethylene discharge hose with curved spout and connector to fit Auveco barrel pump 16283.

UNIT PACKAGE: 1

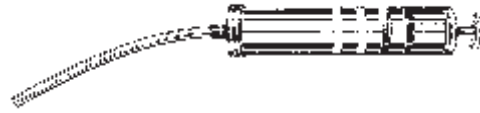

**16293**

**Suction Gun**  
 Designed for all purpose draining and filling clutches, differentials and transmissions. Use with any type of non-corrosive lubricants. Needs no priming. One pint capacity. Comes with 11" flexible vinyl hose.

UNIT PACKAGE: 1

**Oil Cans**



Type 1

**16286**

Type 1  
 6 oz. Capacity  
 4" Rigid Spout  
 Brass Pump, Steel Body

UNIT PACKAGE: 1



Type 2

**16287**

Type 2  
 8 oz. Capacity  
 5" Rigid Spout  
 Brass Pump, Steel Body

UNIT PACKAGE: 1



Type 3

**16289**

Type 3  
 6 oz. Capacity  
 7" Flexible Spout  
 Brass Pump, Steel Body

UNIT PACKAGE: 1



Type 4

**16288**

Type 2  
 12 oz. Capacity  
 5" Rigid Spout  
 Brass Pump, Steel Body

UNIT PACKAGE: 1

**16291**

Type 4  
 12 oz. Capacity  
 8" Flexible Spout  
 Brass Pump  
 Steel Body

UNIT PACKAGE: 1

# TOOLS

## Hacksaw Blade Frame



**Auveco 7954**

UNIT PACKAGE: 1

## HACKSAW BLADES



### Special Flexible Alloy Steel

Hacksaw Blades  
Blade Size 12" x 1/2"

Intended For General Purpose Use In Sawing Mild Steel, Brass, Aluminum, Copper and Similar Metals. Recommended For Hand And Light Power Use.

Auveco Part No.	Type	Teeth Per Inch	Pcs. Per Unit
<b>10678</b> .....	Special Flexible Alloy Steel .....	18 .....	10 Blades
<b>10679</b> .....	Special Flexible Alloy Steel .....	24 .....	10 Blades
<b>10680</b> .....	Special Flexible Alloy Steel .....	32 .....	10 Blades

### Flexible High Speed Steel

Hacksaw Blades  
Blade Size 12" x 1/2"

High Speed Blades Last The Longest And Cut The Hardest Materials. These Blades While Possessing Superior Cutting Qualities Are Flexible To Resist Breaking.

Auveco Part No.	Type	Teeth Per Inch	Pcs. Per Unit
<b>10686</b> .....	Flexible High Speed Steel .....	18 .....	10 Blades
<b>10687</b> .....	Flexible High Speed Steel .....	24 .....	10 Blades
<b>10688</b> .....	Flexible High Speed Steel .....	32 .....	10 Blades
<b>10690</b> .....	Flexible High Speed Steel .....	18 .....	50 Blades

### Blade Selection Chart

Recommended Number Of Teeth Per Inch

Material Thickness	Hard Materials	Soft Materials
Up to 1/8"	32	32
1/8" to 1/4"	24	24
1/4" to 1/2"	24	18
1/2" to 1"	18	14

# O.E.M. INTERCHANGE BY MANUFACTURER

The O.E.M. numbers listed in this interchange are cross referenced to the closest equivalent Auveco part. In some instances, the parts are not identically the same. There may be slight differences in the finished, length, washer O.D.: however, the Auveco part is designed to service the same application.

This interchange is not listed in strict numerical order (from the lowest number to the highest number.) Rather it is arranged in numerically ascending order from the left regardless of the number of digits in each O.E.M. number. Thus every number that begins with a 1 is listed before any number that begins with a 2. You should key on the first four digits to locate the number. For example, 1121865 is located before 11229 and after 11189734. OEM numbers that begin with a letter precede OEM numbers that begin with a numeral.

O.E.M. No.	Auveco No.	Page No.	O.E.M. No.	Auveco No.	Page No.	O.E.M. No.	Auveco No.	Page No.	O.E.M. No.	Auveco No.	Page No.
<b>AC-DELCO</b>			<b>ALEMITE</b>			2357 .....17999.....202			13-8003 .....15014.....86		
L562 .....20402.....249			1641-B .....9257.....222			2357NA .....18000.....202			13-8004 .....15015.....86		
L891 .....20598.....205			<b>AUDI</b>			2396 .....17998.....202			<b>BMW</b>		
LS101 .....9883.....177			N10320101 .....16897.....204			24 .....18017.....202			07-11-9-901-294 .....13215.....534		
PT181 .....12564.....153			N90561601 .....18661.....205			24NA .....18018.....202			07-11-9-916-945 .....13215.....534		
PT516 .....13547.....186			N90561601 .....20601.....205			293 .....18467.....202			07-12-9-925-708 .....13223.....533		
PT549 .....11440.....185			113-857-219A .....13206.....574			3057 .....16915.....202			07-12-9-925-720 .....13162.....498		
PT663 .....12751.....199			801-867-299/041 .....13202.....574			3057NA .....16916.....202			07-12-9-925-730 .....13222.....498		
16-7552 .....9481.....152			803-853-139A .....13189.....573			3155 .....17997.....202			07-12-9-925-737 .....13218.....534		
614 .....12629.....164						3156 .....17996.....202			07-12-9-929-706 .....13221.....498		
616 .....12628.....164			<b>AUTOMOTIVE BULBS</b>			3156NA .....18475.....202			41-33-5-480-120 .....13164.....497		
<b>ACURA</b>			<b>(Industry Standard No.)</b>			3157 .....16917.....202			51-11-1-908-077 .....20234.....497		
33115-S84-A11 .....16897.....204			HB2-12V60W55W .....18661.....205			3157NA .....18476.....202			51-11-8-174-185 .....20248.....497		
33303-S30-003 .....19206.....202			HB2-12V60W55W .....20601.....205			3157SA .....18479.....202			51-13-1-802-389-B .....12642.....550		
33303-SL4-003 .....19206.....202			H3 .....20600.....205			3357 .....18477.....202			51-13-1-804-205 .....13158.....496		
34906-S30-003 .....19207.....202			H3-12V55W .....20600.....205			3357NA .....18478.....202			51-13-1-848-312 .....13171.....496		
34906-ST5-003 .....19207.....202			H4 .....18661.....205			3457 .....20587.....203			51-13-1-849-724 .....13163.....496		
71807-SL0-000 .....19423.....489			H4-12V60W55W .....18661.....205			3457NA .....20588.....203			51-13-1-869-959 .....16117.....496		
74144-SR3-000 .....19624.....329			H4-12V60W55W .....20601.....205			3496 .....20296.....203			51-13-1-885-399 .....16115.....497		
80871-ST7-000 .....18141.....321			P21/5W .....20593.....203			3497 .....20297.....203			51-13-5-680-113 .....13159.....497		
80872-ST7-000 .....18140.....321			P21W .....20592.....203			3652 .....20298.....203			51-13-8-124-389 .....20254.....497		
80873-ST7-000 .....18137.....321			PR2 .....16927.....202			37 .....18465.....202			51-14-1-902-279 .....20186.....497		
8-94215-211-0 .....19229.....494			R5W .....20590.....203			4157LL .....20620.....203			51-18-1-821-830 .....18156.....35		
8-94467-458-5 .....19227.....490			T4W .....20589.....203			4157NALL .....20621.....203			51-18-1-852-299 .....13166.....497		
8-97098-397-0 .....19230.....494			W5W .....20591.....203			5007 .....20590.....203			51-21-6-442-159 .....13167.....497		
8-97134-978-0 .....19227.....490			1003 .....16918.....202			53 .....16914.....202			51-21-8-205-295 .....20388.....497		
90001-SG0-003 .....14291.....508			1004 .....16920.....202			55 .....20282.....203			51-31-1-938-494 .....17279.....496		
90113-SL0-T01 .....17417.....247			1034 .....16925.....202			58 .....20288.....203			51-31-8-177-850 .....17279.....496		
90157-SP0-901 .....19226.....499			1073 .....18004.....202			561 .....18010.....202			51-41-1-802-258 .....13170.....497		
90505-SL0-003 .....19140.....569			1076 .....18469.....202			562 .....20289.....203			51-41-1-973-500 .....20253.....497		
90601-SK7-003 .....18759.....490			11005 .....20299.....203			57 .....16910.....202			51-47-1-840-960 .....20403.....496		
90611-SK7-003 .....18763.....490			11006 .....20300.....203			570 .....20290.....203			51-47-1-840-961 .....13172.....496		
90612-SK7-003 .....18765.....491			1141 .....16923.....202			577 .....18009.....202			51-47-1-928-808 .....20255.....496		
90621-SK7-003 .....18756.....490			1142 .....20681.....203			63 .....20283.....203			51-48-1-938-725 .....20270.....497		
90661-ST7-003 .....18456.....492			1155 .....18470.....202			631 .....18468.....202			51-71-1-916-197 .....17645.....496		
90666-SA7-003ZW .....19506.....493			1156 .....16904.....202			67 .....16905.....202			51-71-1-916-199 .....17646.....497		
90666-SS0-003 .....19740.....489			1156 .....19608.....207			68 .....20292.....203			51-71-8-108-613 .....20333.....496		
90667-SD4-003 .....19464.....494			1156NA .....17597.....202			73 .....20284.....203			52-20-8-238-999 .....13167.....497		
90668-SP0-003 .....19448.....496			1157 .....16899.....202			74 .....18016.....202					
90676-SD2-003 .....17268.....492			1157 .....19609.....207			7440 .....19206.....202			<b>BUDD</b>		
90688-SB0-013 .....14698.....513			1157NA .....16901.....202			7443 .....19207.....202			10708 .....12522.....85		
90700-SJ4-000 .....18746.....494			1157NA .....19610.....207			7506 .....20592.....203			10709 .....12520.....85		
91501-SG0-003 .....17440.....489			1176 .....20585.....203			7528 .....20593.....203			35336 .....15003.....86		
91501-SL4-003 .....19467.....493			1178 .....20586.....203			880 .....20594.....205			35337 .....15004.....86		
91501-SP1-003 .....19225.....489			1195 .....18471.....202			881 .....20595.....204			37888 .....12525.....85		
91502-SG0-003 .....17445.....492			12100 .....17995.....202			885 .....20596.....205			37889 .....12524.....85		
91502-SZ5-003 .....19232.....495			1255 .....20600.....205			886 .....20683.....204			37891 .....12523.....85		
91503-SOK-A01 .....20608.....513			1260/H4 .....18661.....205			889 .....20597.....204			37892 .....12521.....85		
91503-SK7-013 .....19723.....493			1260/H4 .....20601.....205			89 .....16911.....202			95188 .....15011.....86		
91503-SP0-003 .....17267.....496			1295NA .....19208.....202			891 .....20598.....205					
91503-SZ3-003 .....19233.....495			13050 .....17994.....202			893 .....20599.....205			<b>CHRYSLER</b>		
91503-SZ5-003 .....20564.....513			1445 .....18472.....202			894 .....20684.....204			F155EK1 .....14961.....460		
91504-SP1-003 .....19507.....489			1449 .....18473.....202			90 .....18015.....202			F155GL7 .....14965.....460		
91505-SL0-003 .....19231.....495			158 .....18014.....202			9003 .....18661.....205			F155GR8 .....14966.....460		
91511-SP0-003 .....17324.....489			161 .....20285.....203			9004 .....16896.....205			JB66PB7 .....18089.....372		
91512-SP1-000 .....18762.....492			1638 .....20295.....203			9005 .....16897.....204			JB66PD5 .....18087.....372		
91512-SX0-003 .....19239.....512			168 .....16921.....202			9005LL .....20682.....204			J3081054 .....18035.....461		
91513-SP0-003 .....17323.....489			17131 .....20589.....203			9006 .....16898.....204			J4003084 .....185.....229		
91513-SP1-003 .....18755.....490			17171 .....20590.....203			9007 .....18662.....204			J4004175 .....9298.....82		
91514-SP0-003 .....18764.....491			17177 .....20591.....203			904 .....20291.....203			J4004354 .....9297.....82		
91514-SP1-003 .....18760.....492			17635 .....20592.....203			906 .....16922.....202			J4004354 .....10087.....82		
91515-SR3-000 .....19483.....511			17916 .....20593.....203			912 .....18008.....202			J4005293 .....10087.....82		
91526-SP0-003 .....18768.....491			1815 .....18474.....202			916 .....18006.....202			J4006956 .....18163.....85		
91526-SP1-003 .....18767.....492			1816 .....16919.....202			916NA .....18007.....202			J4007456 .....20419.....462		
91527-SP1-003 .....18757.....491			1889 .....18003.....202			917 .....20293.....203			LR69PB7 .....18089.....372		
91528-SP1-003 .....18758.....491			1891 .....18002.....202			921 .....18005.....202			LR69PD5 .....18087.....372		
91533-ST0-003 .....19668.....490			1893 .....16909.....202			922 .....20294.....203			L0009006XS .....16898.....204		
91535-SP0-003 .....18754.....491			1895 .....16906.....202			93 .....16926.....202			L01255H3 .....20600.....205		
91536-SP0-003 .....18761.....490			192 .....20286.....203			97 .....16912.....202			MB566719 .....19802.....374		
91537-SP0-013 .....18236.....493			193 .....18013.....202						MB567798 .....19814.....457		
91560-SZ3-003 .....19466.....494			194 .....16902.....202			<b>AVDEL/CHERRY</b>			MB888869 .....19140.....569		
91561-SW5-003 .....19479.....492			194 .....19611.....207			SSC42 .....5750.....234			MR200300 .....20247.....538		
91568-SL4-003 .....17608.....492			194NA .....18012.....202			SSP42 .....5748.....234			MS820959 .....16897.....204		
91575-SL4-004 .....18235.....489			194NA .....19612.....207						MU435004 .....16254.....99		
91641-SH3-013 .....19679.....507			198 .....16924.....202			<b>BATCO</b>			OH452KD5 .....17080.....459		
91651-SZ3-003 .....19463.....493			199 .....18466.....202			13-3008-L .....15004.....86			QL77SC1 .....19382.....370		
91652-SP0-003 .....19465.....493			2040 .....19209.....205			13-3008-R .....15003.....86			QL77SJJ .....19384.....370		
91652-SZ3-003 .....19466.....494			2057 .....16907.....202			13-3026-L .....15010.....86			QL77SK4 .....19383.....370		
91652-SP0-003 .....19465.....493			2057NA .....16908.....202			13-3026-R .....15009.....86			TY98TL2-AA .....20541.....370		
91652-SZ3-003 .....19466.....494			211-2 .....16913.....202			13-6002 .....15016.....87			08-54-699-800 .....13207.....550		
			212-2 .....18011.....202			13-6003 .....15017.....87			152863 .....16581.....453		
			222 .....20287.....203			13-6005 .....15018.....87			152867 .....11832.....453		
<b>ALCOA, EUCLID</b>											
5988-L .....15010.....86											
5988-R .....15009.....86											

# O.E.M. INTERCHANGE BY MANUFACTURER

O.E.M. No.	Auveco No.	Page No.	O.E.M. No.	Auveco No.	Page No.	O.E.M. No.	Auveco No.	Page No.	O.E.M. No.	Auveco No.	Page No.
153297	16478	29	4005714	15813	466	55055098	18248	374	6031147	8865	82
154508	16531	30	4006204	11470	390	55075139	17214	411	6031183	14218	455
154534	16534	30	4006211	13570	337	55075208	14562	465	6031234	13647	454
1560058	19626	578	4006316	13965	101	55134797	13570	337	6031321	10831	365
1560058	19627	578	4006516	11612	363	55156429-AA	20523	457	6031383	11704	459
1624705	2744	578	4006529	15040	364	55176248	14020	444	6031390	11699	413
1624705	12959	578	4006848	12943	135	55256967-AC	19816	335	6031438	12995	97
1758099	2752	579	4019472	12943	135	55275388	19815	335	6031438	12996	97
1758099	12960	579	4033711	14552	465	55275388-AB	19815	335	6031495	16538	30
1900654	9361	350	4040732	18509	373	55350747-AB	19775	377	6031551	19437	351
2072728	8746	85	4055028	13542	197	56001419	15666	573	6031644	16537	25
2074089	8971	611	4095145	12929	133	56017580	14894	158	6031869	12713	551
2076405	14169	608	4100727	12932	135	56017580	16350	158	6031875	19152	463
2096454	17115	159	4103165	14216	461	6000258	19537	101	6032061	12566	396
2096466	14892	159	4104998	12937	133	6000558	10073	101	6032083	16851	82
2096467	15504	159	4114785	12134	351	6000605	5854	101	6032138	16687	252
2409826	8742	85	4124721	12598	197	6000705	2619	579	6032363	11351	368
2448770	16873	590	4167810	12920	134	6000705	12958	579	6032516	13466	454
2486468	17434	465	4179981	12946	134	6000720	2752	579	6032838	14979	448
2496279	9905	177	4179982	12944	135	6000720	12960	579	6032856	17615	251
2524525	8419	454	4198993	16729	464	6000943	9377	551	6032926	12655	249
2524526	16583	453	4201198	12934	134	6002893	10622	339	6032926	14486	249
2534814	14461	611	4241054	12939	135	6002893	11611	339	6032975	14562	465
2664040	14985	461	4241296	12930	133	6003147	11354	457	6033018	20332	363
2745108	10262	462	4241362	12916	134	6003219	13616	457	6033082	17664	366
2889061	17116	159	4270581	11848	453	6003220	8853	373	6033376	16995	453
2945108R	10262	462	4274166	17117	159	6003349	11678	379	6033560	15345	82
2945109	10262	462	4275973	13465	461	6003351	11136	374	6033677	14756	436
2945109L	10262	462	4304729	16804	158	6003368	11701	379	6033688	18810	256
2964547	11129	362	4307218	12943	135	6003409	13567	339	6033840	17664	366
2998430	10332	367	4314873	15681	334	6003409	20276	339	6033862	11349	378
32000404	18267	461	4334140	11848	453	6003423	11673	368	6034213	10375	82
3230375	13472	447	4334141	11848	453	6003575	13615	457	6034336	19310	463
3236813	12927	135	4334142	11848	453	6003587	11675	363	6034376	18373	218
3237451	12949	135	4336115	17167	465	6003609	12794	456	6034703	18934	33
3239826	12935	133	4341060	17004	371	6003632	11936	457	6034812	19310	463
34201287	16826	36	4368163	16802	158	6003647	12913	457	6034848	19657	251
34201358	15331	64	4368618	15499	155	6003752	20276	339	6034944	16988	243
34201545	12993	551	4368960	16803	158	6003858	13847	457	6035094	2562	82
34201621	12567	413	4370138	17101	242	6003861	13843	456	6035122	19751	253
34201631	18108	242	4381395	20316	368	6003873	13845	457	6035188	18934	33
34201872	19276	455	4400588	13542	197	6003878	13567	339	6035201	17639	257
34202159	17495	65	4428987	19155	372	6003878	20276	339	6035201	19263	257
34202672	13993	415	4437565	12237	177	6003965	13927	457	6035204	18494	32
34202839	18158	362	4486948	11157	178	6004036	17151	457	6035274	14037	396
3426388	2272	466	4498100	14552	465	6004162	17064	457	6035401	20179	454
3441734	12930	133	45998051	12119	66	6004212	14005	242	6035414	19406	251
3441743	12930	133	4630088	18028	242	6006264	3404	83	6035417	18373	218
3454220	15673	462	4630088	18031	242	6010029	19626	578	6035807	19310	463
3454221	15674	462	4630253	18029	458	6010029	19627	578	6035821	20524	455
3509575	9905	177	4630660	18031	242	6010046	2752	579	6036042AA	19784	463
3513686	13542	197	4636359	18919	197	6010046	12960	579	6036083-AA	20419	462
3574085	11653	453	4636360	18921	197	6010093	2744	578	6036148-AA	20629	252
3588314	13541	197	4636361	18920	197	6010093	12959	578	6036310AA	18163	85
36000148	15666	573	4636362	18920	197	6013029	2619	579	6100042	11629	110
36001966	15666	573	4638136	14993	411	6013029	12958	579	6100047	19216	64
3671410	12918	134	4658444	19191	463	6013122	11677	380	6100048	15329	64
3673945	12918	134	4658445	19190	463	6016247	12133	446	6100049	15331	64
3691590	10831	365	4658673	19149	362	6022582	16773	82	6100050	15333	64
3691590	16259	365	4658676	10262	462	6023120	16929	65	6100567	19455	52
3693099	14217	420	4658676	20675	462	6023171	10053	107	6100568	15818	52
3696693	10843	336	4658677	10262	462	6023204	15345	82	6100775	12254	66
3744734	10843	336	4658887	20165	362	6023718	18811	234	6100810	12115	66
3744750	12237	177	4676356	19339	463	6023925	8242	39	6100811	12253	66
3751212	12923	134	4696129	18033	373	6025002	15342	82	6100814	19548	66
3759944	18770	362	4696488	14995	411	6025004	15345	82	6100815	16829	66
3764556	18414	158	4696963	18826	368	6025005	15347	82	6100839	12122	66
3764863	12599	197	4717224	19855	365	6025007	15350	82	6101283	11629	110
3764865	12598	197	4759514-AB	20356	456	6025329	9480	26	6101308	18449	109
3767196	18979	335	4805119	19785	454	6025502	9429	107	645350	1256	350
3775994	18770	362	4805336-AA	19642	456	6025502	10047	107	6500092	12617	85
3799089	14858	462	4805405-AA	19638	461	6026166	16237	99	6500284	15329	64
3843245	12598	197	4805405-AB	19638	461	6026430	9299	82	6500361	14561	465
3843345	12628	164	4805570-AA	20526	463	6026686	10215	463	6500526	12715	85
3843386	14893	158	4857345-AA	20457	460	6026723	10655	22	6500650	15860	590
3843386	16349	158	4860375-AB	20667	455	6026723	10656	22	6500651	15861	590
3843392	12627	164	4878883-AA	20164	371	6026723	10657	22	6500722	15862	590
3843432	13233	197	5BB14LX9	19245	460	6026724	10078	23	6500725	14800	454
3843601	14894	158	5FR56DX9	19894	457	6026724	10079	23	6500787	14016	414
3843601	16350	158	5GC71RC3AA	20273	443	6026724	10083	23	6500859	13754	242
3861577	11347	363	5GF92RC3AA	20273	443	6026815	16335	25	6500898	13755	242
3861577	11679	363	5008055-AA	20309	342	6026958	10086	82	6500911	13750	242
4000141	11697	466	5010366-AA	19791	468	6027221	14999	25	6501025	12125	66
4000155	8719	608	5012874-AA	19628	376	6027924	10080	463	6501067	15481	367
4001916	18508	373	5020040-AA	20418	330	6027958	19485	536	6501086	20316	368
4003120	13004	99	5023111-AA	19804	377	6028993	14562	465	6501220	19718	59
4003672R	10262	462	5023351-AA	19804	377	6029348	16852	82	6501301	16818	364
4003673L	10262	462	5027550-AB	20312	518	6029501	12735	574	6501415	16980	66
4004569	10831	365	5027550-AC	20312	518	6030441	11146	366	6501509	18242	242
4004569	16259	365	5028438-AA	20428	377	6030441	15414	366	6501559	13751	242
4005099	11349	378	5201359	11848	453	6030538	10832	365	6501577	17106	414
4005237	16246	99	5201359	11849	453	6031091	11621	249	6501590	14019	445
4005250	11350	370	5208743	15040	364	6031091	16838	249	6501630	17104	458
4005470	11678	379	5255110	18979	335	6031115	11620	248	6501699	17354	455
4005540	11152	337	55022134	15042	417	6031115	16837	248	6501772	17104	458

# O.E.M. INTERCHANGE BY MANUFACTURER

O.E.M. No.	Auveco No.	Page No.	O.E.M. No.	Auveco No.	Page No.	O.E.M. No.	Auveco No.	Page No.	O.E.M. No.	Auveco No.	Page No.
6501773	12569	436	6507219-AA	20436	54	C8AZ-63442413-A	9882	339	D8TZ-13466-A	18472	202
6501825	12259	66	7368261	16801	158	C8AZ-63642413-A	9882	339	D8TZ-9823394-A	20685	344
6501852	19266	458	7703-077-066	12993	551	C8OZ-13713-A	13438	209	D8UZ-19805-A	19081	346
6501863	19241	378	812893	12600	179	C8TZ-13466-A	16899	202	D90Z-6522841A	14551	451
6501878	17104	458	83501000	12599	197	C8TZ-13466-A	19609	207	D9AB14A163JC	12622	446
6501916	15543	366	8350400	19319	217	C9OZ-13713-A	13438	209	D9AB-74519B18-AA	14758	380
6501925	18030	415	83504041	19318	221	C9AZ-13713-A	13438	209	D9AE-9E645-AA	12921	134
6501948	19893	364	8880417	15672	458	C9AZ-62234A24-B	17257	343	D9AZ-14474-F	16344	158
6502078	20456	362	8934-201-235	13464	551	C9MY-13713-A	13438	209	D9AZ-14A163-J	12622	446
6502081	16871	590	8934-201-262	11855	551	C9OB-13713-A	13438	209	D9AZ-54234A46-AA	19193	336
6502083	16872	590	8934-201-263	9377	551	DITZ-13032-B	11662	433	D9BZ-3623394-A	20685	344
6502085	16873	590	8934201287	16826	36	DOAZ-5323395-A	20686	344	D9BZ-3623395-A	20686	344
6502087	16874	590	8934-201-493	16256	99	DODZ-6203174-C	10625	339	D9BZ-5401316-B	14768	435
6502089	16875	590	8934-201-602	12713	551	DOAZ-5323394-A	20685	344	D9BZ-5402316-B	14768	435
6502090	16877	590	8934-201-681	13475	574	DOAZ-5723394-A	20685	344	D9BZ-5423394-A	20685	344
6502091	16878	590	8934-201-767	13966	551	DOAZ-5723395-A	20686	344	D9BZ-5423395-A	20686	344
6502104	18771	369	8934-201-835	17496	242	DOAZ-62234A24-B	17257	343	D9BZ-13A093AA	12609	433
6502152	16846	109	8934-202-078	15495	242	DOAZ-62234A24-B	17974	343	D9ZZ-6643030-AA	19594	451
6502328	14921	363	8934-202-293	16251	99	DODZ-15A434-B	9883	177	ELOB-6645A30-AA	12229	212
6502381	18815	363	8934-202-428	17100	378	DOZB-13A-093-AA	11660	433	EOVB-13A-506-BA	12133	446
6502450	16876	590	8934-202-599	17102	375	D1AB-13713-A	13438	209	E0SZ-13466-A	20291	203
6502491	16870	590	8936000	15666	573	D1AB-14461-AA	14887	157	E0TZ-1063-226-AC	16213	388
6502545	18237	461	8936001	15666	573	D1AB-6542413-AB	9882	339	E0VE9K319-AB	12938	134
6502573	18032	458	8956001	15666	573	D1AZ-13410-A	19813	195	E0VY-13A506-A	17164	446
6502625	16835	412	9411943	3401	83	D1AZ-13410-B	13537	188	E1EB-61046A48-BA	12606	448
6502689	18501	242	9419322	13022	32	D1AZ-13713-C	13438	209	E1EZ-9E499-EA	18835	134
6502738	17353	85	9422202	13708	28	D1AZ-6522841-A	14550	429	E1VY-14474-B	16345	158
6502745	16868	590	9422246	13707	28	D1AZ-6542413-B	9882	339	E1VY-6623394-A	19071	344
6502776	18102	448	9423950	15827	31	D1FZ-13234-A	14135	189	E1ZE-9E499-CA	18836	135
6502842	17975	371	9427977	13709	32	D1FZ-13466-B	16913	202	E1ZE-9E499-EA	18835	134
6502871	14992	442	9428273	13027	31	D1FZ-6222600-A	12470	452	E25Y-14421-C	16342	158
6502907	17669	376	972724	4244	328	D1TZ-13032-B	11662	433	E25Y-14421-CA	16342	158
6502907	18915	376				D2AB-13021-AA	11669	434	E27B-1063226-AC	16214	388
6502988	19519	422				D2AZ-6522008-A	18892	451	E27B-14474-BA	18854	158
6502991	17685	376				D2FZ-6222600-A	12470	452	E2EB-6120C62-AA	19154	438
6503106	18269	460				D2KB-13021-AA	12227	434	E2EB-61290C62-AA	19154	438
6503108	18034	454				D2OB-13A093-AA	11660	433	E2GZ-6723342-A	13030	452
6503163	14997	411				D2OB-13A093-AA	11661	433	E35Y-13466-A	20294	203
6503169	18532	64				D2OZ-14474-F	16805	158	E35Y-13466-B	18012	202
6503174	19794	464				D2OZ-5323394-A	20685	344	E3AZ-5423394-A	20685	344
6503204	18862	376				D2OZ-5323395-A	20686	344	E3AZ-5423395-A	20686	344
6503221	12766	368				D2SB-65045A28-AA	12610	439	E3AZ-54233V95-ARM	20686	344
6503274	18035	461				D2SZ-65045A28-B	12610	439	E3MY-13466-A	18006	202
6503339	18249	461				D2VZ-6521952-A	14967	425	E3SB-6342413-AB	13564	339
6503373	18825	455				D3AA-90826-AA	10837	447	E3TB-1063-226AA	16213	388
6503401	19417	60				D3AB-14474-DA	14889	158	E3TZ-9843052-A	19167	450
6503433	18375	219				D3AZ-13410-A	13535	188	E3VB-14461AA	18853	158
6503453	18394	461				D3AZ-13410-B	13533	188	E3VB-144861-AA	18853	158
6503454	18327	459				D3AZ-13410-E	14131	189	E3VB-14488-AA	18852	158
6503598	17216	416				D3AZ-13410-G	14132	189	E43Z-5423394-A	20685	344
6503709	19213	375				D3AZ-14526-D	12629	164	E43Z-5423395-A	20686	344
6503768	18301	364				D3AZ-14526-D	15372	164	E4FZ-14474-AA	18408	157
6503800	13748	242				D3AZ-14526-E	12628	164	E4FZ-8C290-A	17619	193
6503812	19779	464				D3AZ-14526-E	15371	164	E5AZ-13466-A	18476	202
6503819	19417	60				D3AZ-14526-H	12628	164	E5LB-13A147AA	15814	434
6503837	18531	81				D3AZ-14526-J	12629	164	E5LY-13A147-A	15814	434
6503860	17101	242				D3AZ-14526-Z	12627	164	E5LY-13N021-A	16896	204
6503892	18827	374				D3AZ-5723394-A	20685	344	E5TZ-1023394-A	20685	344
6503938	18913	242				D3AZ-5723394-B	20685	344	E5TZ-1023395-A	20686	344
6503943	20189	367				D3AZ-5723395-A	20686	344	E5ZZ-12A209-A	18217	192
6504014	17669	376				D3AZ-5723395-B	20686	344	E6AZ-5421952-A	15675	450
6504014	18915	376				D3AZ-5723395-ARM	20686	344	E6DC-2B223AA	15524	446
6504018	19141	220				D3AZ-6523394-A	20685	344	E6DZ-13032-A	15968	431
6504043	17612	366				D3AZ-6523395-A	20686	344	E6DZ-13032-B	15969	431
6504072	19793	455				D3AZ-9823395-A	20686	344	E6DZ-13466-B	18005	202
6504090	12567	413				D3OZ-16776-A	11136	374	E6DZ-13K040-B	15634	433
6504098	19338	370				D42B-6021066-BA	14213	439	E6DZ-14A411-A	18676	191
6504135	19541	367				D4AZ-13466-A	18465	202	E6DZ-5421952A	17122	450
6504424	18375	219				D4LY-13410-A	14133	189	E6DZ-5421970-A	17119	450
6504521	19422	460				D4MY-13466-A	18011	202	E6DZ-5421971-A	17118	450
6504601	19779	464				D4OZ-13234-A	14128	189	E6FZ-13466-B	18016	202
6504700	13750	242				D4ZZ-13234-A	14130	189	E7EB-14421-EA	16342	158
6504870AA	19809	456				D5HZ-14461-A	18411	157	E7EB-14461-BA	20475	157
6504980AA	19540	367				D5UB-2221066-AA	12559	439	E7EB-14474-CA	16344	158
6505049AA	20317	463				D5ZZ-16828-A	17338	447	E7EB-14487-AA	18408	157
6505149AA	18531	81				D6EA-1A100-AA	11702	443	E7GZ-17A90-B	15366	528
6505161AA	19640	454				D70B-13A093-AA	11662	433	E7GZ-6120586-B	18692	564
6505292AA	19386	376				D7OZ-13032-B	11662	433	E7SB-13A093AA	15965	432
6505319AA	19792	462				D7OZ-13410-A	14136	188	E7SB-13A093BA	15966	432
6505417AA	19836	362				D7SZ-13032A	11662	433	E7SZ-13032-C	15965	432
6505539AA	19628	376				D7TZ-13466-A	18008	202	E7SZ-13032-D	15966	432
6505703AA	20267	455				D7VY-6050074-A	13966	551	E7SZ-6323394-A	20686	344
6505759-AA	20427	377				D7WY-6523394-A	20685	344	E7SZ-6323395-A	20685	344
6505813AA	18934	33				D7WY-6523395-A	20686	344	E7TB-13A093-AB	16402	432
6505863AA	20420	462				D8BB-13M093-AA	11869	433	E7TZ-1023394-A	20685	344
6505918-AA	20515	376				D8BB-13M093-AA	11870	433	E7TZ-1023395-A	20686	344
6506005AA	20361	364				D8BB-14474-BA	14889	158	E7TZ-13032-A	16402	432
6506008AA	19639	415				D8BB-7420828-AA	14137	439	E7ZB-6120908AC	15812	439
6506104AA	20173	464				D8BZ-13032-A	11869	433	E7ZZ-13466-B	18007	202
6506132AA	20458	460				D8BZ-13032-A	11870	433	E804-14526A	15926	175
6506293AA	20361										



# O.E.M. INTERCHANGE BY MANUFACTURER

O.E.M. No.	Auveco No.	Page No.	O.E.M. No.	Auveco No.	Page No.	O.E.M. No.	Auveco No.	Page No.	O.E.M. No.	Auveco No.	Page No.
E83Z-5421952-B	17122	450	F5RZ-17K657-A	20425	436	N803043-S	13750	242	N807994-S	18816	438
E8AZ-13466-A	17996	202	F5RZ-5421416-B	19281	435	N803170-S	14021	362	N808048-S	16726	444
E8BZ-17C756-C	17450	528	F5TZ-6734-BA	20453	217	N803183-S32	14814	103	N808147-S	14991	411
E8EB-13A093-AA	16396	432	F65Z-15020C34-AA	19536	447	N803387-S	15668	371	N808182-S309	19436	449
E8EB-13A093-AB	16396	432	F65Z-15020X34-AA	19536	447	N803387-S300	15668	371	N808331-S	18895	442
E8EB-13A093-BA	16397	432	F6DZ-5402316-AA	19238	437	N803421-S	14019	445	N808332-S	18894	442
E8EB-14421-LA	16343	158	F6DZ-5410182-AA	20358	439	N803494-S	14953	441	N808342-S307	20546	448
E8EB-14461-A	18411	157	F6TZ-6730-BA	19279	220	N803613-S	16863	371	N808370-S	19127	367
E8EB-14474-AJA	16345	158	F75Z-13N129-AA	19180	434	N803638-S36B	14895	449	N808426-S100	19396	256
E8EB-14474-AKA	16346	158	F75Z-6730-BA	19773	220	N803678-S	20332	363	N808594-S100	18396	249
E8EB-14474-AMA	16805	158	F7CZ-17C756-BA	20336	437	N803685-S11	14820	423	N808689-S417	19458	250
E8EB-14474-VA	16348	158	F7DZ-5402316-AA	19238	437	N803709-S	17103	414	N808791	20273	443
E8EB-14488-UA	18412	157	F7UZ-1513284-BA	19421	449	N803716-S	14018	444	N808842-S	19338	370
E8FZ-13032-A	16396	432	F7UZ-15238A32-AAC	19413	357	N803734-S	15480	367	N808847-S	19244	444
E8FZ-13032-B	16397	432	F85Z-1521952-BB	19651	450	N803763-S100	20415	423	N808908-S	19337	445
E8FZ-5802354-A	19845	369	F8DZ-54265A99-AA	20630	450	N803768-S	18155	435	N811006-S	18936	380
E8OY-5423394-B	20686	344	KA80-51PR6	18882	522	N803857-S	20311	362	N811090-S100	20413	258
E8OY-5423395-B	20685	344	MB455-56143	17632	527	N803862-S	13751	242	N811169-S	19783	559
E8TZ-9823394-A	20685	344	NAO1-56145	16858	547	N803933-S101	17408	250	N811257-S100	20421	449
E92Z-13032-B	17457	433	N605771-S100	12341	51	N803946-S	14992	442	N811257-S309	20421	449
E92Z-17C756-C	17060	528	N605771-S2	12341	51	N803968-S100	14819	448	N811259-S	18812	234
E97B-13A093BA	16399	432	N605774-S2	12338	51	N804189-S	13747	242	N811353-S100	20171	437
E97B-13A093-BB	16399	432	N605800-S2	12329	54	N804193-S100	18167	249	N811460-S100	19419	251
E9AZ-5422008-A	18890	451	N605920-S2	12327	54	N804343-S	13748	242	N811534-S61	19653	58
E9DB-13N020AA	15940	434	N606676-S100	12160	51	N804349-S	15479	369	N811772-S	19472	419
E9DZ-13N129-A	15940	434	N606676-S2	12160	51	N804379-S	15478	368	N811849-S300	19517	438
E9DZ-6734B	18299	217	N606676-S36	15778	51	N804448	14757	364	N905150-S	17466	255
E9FZ-5822008-A	18891	451	N606677-S36	12335	52	N804472S	15495	242	OA-13713	13435	209
E9SB-13N019-BA	16425	435	N606677-S43B	15779	52	N804523-S	17431	254	W520802-S426	12669	109
E9SB-6302354-ACW	15523	367	N606677-S53B	15779	52	N804570-S	14753	411	W520815-S436	19901	111
E9SC-2B223AA	15524	446	N606690-S2	15780	54	N804583-S	15187	252	W525170-S	19462	248
E9SZ-13N019-B	16425	435	N606692-S2	16931	54	N804674-S	15701	444	W525170-S417	19414	248
E9SZ-13N021-A	16898	204	N610959-S2	13019	59	N804675S	17101	242	W525172-S	19110	248
E9SZ-13N021-B	16897	204	N620391-S36	17495	65	N804741-S2	19677	448	W525172-S417	19461	248
E9SZ-63030A12-A	19780	335	N620480	15316	64	N804741-S32B	19677	448	W525174-S	19420	249
E9SZ-6323394-A	20685	344	N620480-S2A	15316	64	N804759S	15491	242	W525174-S300	19420	249
E9SZ-6323395-A	20686	344	N620482	15318	64	N804765-S	19277	436	W525175-S	19456	249
E9TZ-6730-B	19365	221	N621900	15325	64	N804837-S	14994	443	W700501-S303	19181	58
E9WB-13A093BA	16405	432	N621903	15326	64	N804851-S100	19516	257	W700548-S300	18382	50
E9WB-13A093CA	16406	432	N621905	15328	64	N804992-S58	10654	4	W700566-S300	18383	435
E9WY-13032B	16405	432	N621906-S36	16774	64	N805017SW	18860	444	W700614-S300	18498	440
E9WY-13032C	16406	432	N621907	15332	64	N805026S	14995	411	W700636-S303	20398	252
FDA13021-A	12228	434	N621940	15335	64	N805083-C	16832	331	W700671-S300	20319	367
F03Z-13032-A	16733	432	N621942-S301	15337	64	N805155-S	17124	375	W700770-S300	19471	364
F09Z-1123394-A	20685	344	N623330-S2	18337	108	N805229-S	14988	441	W700800-S300	18384	435
F09Z-1123395-A	20686	344	N623331-S2	18338	109	N805231S	15522	443	W701054-S300	18503	445
F09Z-11233V94-ARM	20685	344	N623332-S100	12669	109	N805315	17381	370	W701133-S300	18386	446
F0TZ-14489-J	19004	195	N623332-S2	12669	109	N805592-S100	17121	254	W701223-S300	20194	441
F1CZ-13466-C	20595	204	N623332-S53	12669	109	N805612-S	17102	375	W701374-S	20399	363
F1CZ-13A147-A	18899	434	N623333-S100	11629	110	N805612-S100	17102	375	W701380-S5W	18379	364
F1CZ-16774-A	18458	525	N623333-S2	11629	110	N805759-S100	16834	251	W701430-S300	18377	439
F1CZ-5802316-A	19138	525	N623334-S426	20447	111	N805889-S100	19480	110	W701566-S417	18331	257
F1CZ-61101B04-A	17602	440	N623340-S2	11625	108	N805995-S100	18331	257	W701649-S	19237	437
F1CZ-8A188-A	17317	437	N623343-S100	11630	110	N806090-S100	17409	247	W701855-S300	20366	365
F1TZ-1023394-A	20685	344	N623343-S2	11630	110	N806113-S	20189	367	W701971-S	20169	445
F1TZ-1023395-A	20686	344	N623344-S2	18339	111	N806126-S100	17408	250	W701993-S	17604	321
F1TZ-17698-A	19393	342	N800312-S2	15776	59	N806289-S	17339	372	W702010-S300	19532	372
F1TZ-7810182-A	19441	439	N800322-S55	18523	57	N806322-S	18893	442	W702380-S300	18504	447
F1TZ-7823394-A	20685	344	N800369	16422	35	N806334-S	20245	436	W702412-S300	19345	440
F1TZ-7823395-A	20686	344	N800369-S2	16421	35	N806340-S	19850	373	W703505-S301	20306	441
F1ZZ-13466-A	20286	203	N800387-S	11842	370	N806344-S	18275	369	W703507-S300	19805	440
F22Z-16774-A	14709	526	N800466	15325	64	N806345-S433	14947	98	W703842-S300	20193	441
F2AB-5410182-AB	17066	439	N800484-S58	16736	1	N806345-S47	14947	98	W703919-S300	20193	441
F2AZ-5426448-A	19659	336	N800485-S58	16737	1	N806363-S	20264	437	W704881-S300	19237	437
F2DZ-13466-C	20599	205	N800503-S	11841	436	N806511-S32	19823	448	W704958-S300	19511	445
F2PZ-14A464-C	19004	195	N800510-S100	20176	51	N806537	17063	449	W705532-S300	19726	444
F2SZ-14570-A	19426	452	N800540-S100	20176	51	N806577-S	19267	436	W705550-S300	19783	559
F2TZ-13K040-A	19192	431	N800883-S100	17187	24	N806624-S191	18102	448	W705589-S300	11146	366
F2UZ-1602354-AAA	19846	369	N800928-S45	14947	98	N806685-S900	19457	256	W705590-S300	20466	396
F2ZZ-14474-A	16346	158	N800947-S	16893	52	N806795-S	19364	437	W705849-S300	20355	440
F32Z-17C756-S	17003	448	N801078-S58	16361	53	N806830-S100	17639	257	W705955-S300	20177	364
F37Z-13032-A	18739	431	N801117-S100	18401	111	N806830-S100	19263	257	W705956-S300	20233	443
F37Z-13N129-A	18263	434	N801310	15317	64	N806959-S	19235	321	W705957-S300	20518	445
F3DZ-6734-A	18299	217	N801638-S43	12651	254	N807125-S100	17409	247	W706172-S309	20401	449
F3LY-14570-B	17222	414	N801706-S	12569	436	N807154-S	19371	366	W706182-S300	20516	443
F3LY-6321970-A	17119	450	N801829-S100	12610	439	N807154-S	19372	366	W706494-S300	19849	442
F3LY-6321971-A	17118	450	N801851-S45	14947	98	N807154-S	19373	366	W706519-S300	20518	445
F3XY-12044A59-A	18667	442	N801925-S	12565	374	N807155-S	19352	365	W706575-S300	20393	436
F3XY-12044A59-C	18667	442	N801994-S100	19667	363	N807155-S	19354	365	W706713-S300	20367	442
F43Z-54233V94-BRM	20685	344	N802073	15319	64	N807168-S	19111	255	W707606-S300	20517	437
F47Z-19805-A	19082	347	N802081-S100	16932	24	N807189-S100	20171	437	W708035-S300	20531	364
F49Z-19805-A	19083	346	N802190-S53	17613	448	N807247-S	19526	438	W708045-S300	20532	436
F4CZ-13466-A	16917	202	N802190-S53B	17613	448	N807389-S	17216	416	W708088-S300	18770	362
F4PZ-14A411-C	19885	196	N802239-S	17643	446	N807455-S100	18879	449	W708384-S309	20401	449
F4TZ-13N021-B	18662	204	N802241-S	17642	447	N807535-S	19760	367	W708530-S300	20632	416
F4UB-14A464-A	19004	195	N802331-S53	16842	109	N807535-S	19761	367	W708621-S300	20190	376
F4ZZ-13032-C	18357	431	N802376-S	14754	436	N807535-S	19762	367	W709002-SAA	20624	364
F4ZZ-13032-D	18357	431	N802538-S100	14526	105	N807577-S	18895	442	W709767-S300	20663	439
F54Y-13466-A	19209	205	N802734-S	15480	367	N807578-S	18894	442	XL3Z-13N129-AA	19180	434
F57Z-16241-AB	20663	439	N802734-S	19197	367	N807620-S100	18461	251	XL3Z-1E971-AA	19607	443
F57Z-7810182-AAA	19441	439	N802737-S	13469	443	N807706-S	19326	436	XW1Z-5822008-AA	18891	451
F58Z-1											

# O.E.M. INTERCHANGE BY MANUFACTURER

O.E.M. No.	Auveco No.	Page No.	O.E.M. No.	Auveco No.	Page No.	O.E.M. No.	Auveco No.	Page No.	O.E.M. No.	Auveco No.	Page No.
YS4Z-13N021-AA	18661	205	385323-S100	16838	249	10003617	12927	135	10278936	17654	243
YS4Z-13N021-AA	20601	205	385330-S	11136	374	10004121	12943	135	10280777	19543	381
YS4Z-16K262-AA	20191	442	385353-S	12210	133	10004329	13929	393	10281487	20395	423
YS4Z-6730-AA	20347	219	385400	15345	82	10005510	14968	421	10281610	19530	418
1L5Z-17K826-AA	19638	461	385661-S	11351	368	10008002	8814	108	10283414	19368	372
1U5Z-13466-BB	16901	202	385677	19425	373	10008002	10052	108	10285935	19270	378
1U5Z-13466-BB	19610	207	385974-S	19460	255	10009690	13929	393	10287379	20261	52
13235-A	8763	199	386285	13472	447	10009923	12259	66	10287547	20408	406
1476344	16131	577	386299-S	16954	447	10013153	13924	398	10287926	20232	401
16758	4248	328	386553-S	19655	371	10013764	11352	421	10287971	19275	378
16758A	4155	328	387042-S	12939	135	10014363	12997	97	10291232	19392	405
17562	4260	327	387065-S	12932	135	10017487	12931	133	10293836	19438	422
2F1Z-9A317-AA	20482	446	387074-S	12933	135	10017615	14677	219	10297368	19381	406
2F1Z-9A317-BA	20483	447	387182-S	11671	375	10018202	12695	85	10297369	20521	405
23472-S8	10377	23	387258-S	11679	363	10027015	17230	395	10297371	19379	406
352839	4258	328	387466-S	12209	133	10027915	18027	394	10298115	19486	392
353123	1256	350	387477-S	11797	378	10031004	13814	202	10301966	20365	415
353745-S	2598	127	387496-S	11672	379	10032838	12713	551	10308019	20521	405
354341-S	5196	101	387843-S	11705	443	10036503	14023	242	10308063	20520	407
357811	4246	327	387944-S	11706	443	10040001	9282	227	10323057	20607	407
358107	2272	466	387980-S	12948	135	10041588	14527	105	10341794	20464	408
358470	9361	350	388034	12919	134	10051034	15467	341	10363811	20634	374
358560	19626	578	388047-S100	11852	248	10053182	14997	411	10403591	19449	373
358560	19627	578	388047-S102	12653	248	10053388	15045	417	10405030	19368	372
370247-S2N	5586	106	388047-S1021	11852	248	10056725	19502	423	10408480	19527	378
370374-S	4248	328	388047-S1021	12653	248	10062	12253	66	10413086	19438	422
372741-S100	9864	212	388131-S	12925	134	10062366	18117	421	10421018	20338	378
372820-S36	12654	256	388246-S	11612	363	10063599	18683	362	10423553	20481	405
372820-S40	12654	256	388248-S-36B	11768	103	10069112	15488	242	10425306	20365	415
373415	9865	212	388442-S100	12652	258	10073833	12992	380	10431524	19757	406
373528-S32	5854	101	388442-S309	12652	258	10077283	15042	417	10431761	19821	408
373846-S	12918	134	388442-S309	19509	258	10078274	18897	364	10437565	19800	407
375203-S	17467	250	388577-S	11146	366	10082288	18390	406	10442914	20353	405
375372-S	5592	374	388577-S	15414	366	10084751	19644	110	10443956	20328	407
375480-S100	5195	101	388664-S100	14127	254	10089262	14987	411	10443956	20377	407
375480-S102	5195	101	388904-S	20316	368	10098645	18682	363	10476561	9282	227
375890-S102	11293	100	388908-S	14163	371	10102434	17436	428	106653	12543	174
375936-S	17469	250	388916-S	12908	133	10108746	16625	416	11054611	11711	65
376337-S100	9853	22	388930-S	12909	369	10109689	15490	242	11500081	12347	60
376337-S100	9854	22	389129-S	12907	133	10119816	18859	364	11500086	12350	60
376337-S100	9855	22	389138	12937	133	10119853	17128	397	11500421	2775	4
376785	15351	82	389144-S	17075	378	10120608	18929	257	11500434	15373	58
376785-S2	15351	82	389258	10831	365	10121502	17664	366	11500654	18337	108
376842-F100	12261	83	389268-S-100	12658	249	10125439	16864	253	11500655	11625	108
376988-S2	10654	4	389358-S	10831	365	10126901	15669	379	11500656	18338	109
378527	17470	250	389358-S	16259	365	10129981	15811	65	11500657	11626	109
378527-S100	17470	250	389360-S	11865	395	10131511	18461	251	11500658	11628	110
379046-S	8427	36	389443-S	12571	368	10134407	18030	415	11500660	11629	110
379830-S	9862	435	3895904	12923	134	10135796	18118	400	11500661	11630	110
379830-S	14755	435	390017-S2	15774	29	10139822	14991	411	11500662	11631	111
379830-S	14756	436	390018-S	17664	366	10140480	16835	412	11500663	18339	111
379831-S	8814	108	390126-S	14017	363	10143422	17102	375	11500747	11642	64
379831-S	10052	108	390126-S	14857	363	10153057	16695	378	1150081	12347	60
380575-S2	8847	27	390428-S100	17410	253	10154466	18158	362	1150086	12350	60
380613-S	4439	133	390523-S	15675	450	10157547	16939	256	11500971	12348	54
380614-S	4440	133	391304	17606	321	10157900	16622	415	11500994	12057	59
380615-S	12209	133	391304-S100	17606	321	10158124	18175	375	11500996	12339	60
380707-S	11368	39	391305-S100	17607	321	10159259	20379	416	11500997	12354	60
380707-S	11370	37	391396-S100	17604	321	10160960	18935	255	11501105	11633	53
380911-S2	16735	1	391397-S100	17605	321	10167445	19357	404	11501106	11642	64
381671-S	10642	28	45262	10048	107	10167448	18428	403	11501188	13614	54
381801-S2	15774	29	45262	18898	107	10167456	18425	403	11501193	11641	54
381818-S2	9880	105	45263-S101	10050	107	1016937	12669	109	11501194	13620	54
381863-S2	9879	105	45263-S2	10050	107	10169777	20344	362	11501794	12739	56
382163-S	19826	103	45264	10053	107	10182300	20332	363	11501800	15334	64
382413-S2	17460	30	45264-S2	12265	107	10184895	13751	242	11501814	12254	66
382413-S9	17460	30	45265-S2	10054	108	10185866	20178	364	11501835	12253	66
382443-S	4439	133	45266-S2	9429	107	10185925	18301	364	11501836	12255	66
383000	12929	133	45266-S2	10047	107	10186453	18691	418	11501849	12260	66
383000-S	12929	133	45267	10051	107	10195515	14995	411	11501850	11645	65
383001	12930	133	45268-S2	8814	108	10201332	19514	253	11501851	12256	66
383001-S	12930	133	45268-S2	10052	108	10204265	18171	256	11501854	15714	66
383003-S	12937	133	45269	10055	108	10204266	18170	257	11501883	12059	56
383005-S	12931	133	45332	15347	82	10207146	17226	414	11501884	12060	30
383016	12916	134	45334	15345	82	10220168	18688	369	11501889	11644	65
383031	12927	135	55914-S2	13021	33	10220975	18425	403	11501896	12061	56
383033-S100	10780	350	56910-S2	13025	29	10229345	18831	407	11501899	12257	66
383033-S100	11863	350	56911-S2	13711	29	10229437	18680	369	11501903	12062	56
383033-S101	10780	350	56911-S36	13711	29	10237960	19220	423	11502453	12318	59
383033-S101	11863	350	56912-S2	13026	30	10241518	18688	369	11502479	12659	24
383142-S	20310	443	56929-S2	13711	29	10242285	20521	405	11502480	12659	24
383207-S	14217	420	57030-S36	17034	25	10242316	18680	369	11502480	12660	24
383229-S	11104	250	6032838A	14979	448	10242602	20617	406	11502483	12097	57
383229-S	11105	250	6100539	12232	50	10246149	19788	411	11502507	15711	66
383229-S	11106	250	7023030	4204	329	10249241	19501	369	11502556	12251	66
383255-S36	16770	82	800843	12935	133	10257286	19525	376	11502605	11639	53
383356-S	14756	436	801471	12922	134	10261327	19410	398	11502609	11644	65
383693	15338	82	803716-S	14018	444	10262036	18684	362	11502617	11629	110
383847-S	11419	135	91GBA611A08EAW	18387	447	10262143	19247	395	11502624	11639	53
384111-S	12949	135				10270517	20464	408	11502693	12692	53
384432-S	19459	253				10270672	19390	405	11502722	19309	65
384931-S36	17035	27				10271562	19523	396	11502737	12127	66
385189-S100	11620	248				10274528	19438	422	11502759	12126	66
385189-S100	16837	248				10274778	19819	341	11502770	10171	1
385323-S100	11621	249				10277480	19676	395	11502785	11627	110

**FREIGHTLINER**

22-44567-000 .....19844 .....477

**GENERAL MOTORS**

10003294 .....12919 .....

# O.E.M. INTERCHANGE BY MANUFACTURER

O.E.M. No.	Auveco No.	Page No.	O.E.M. No.	Auveco No.	Page No.	O.E.M. No.	Auveco No.	Page No.	O.E.M. No.	Auveco No.	Page No.
11502790	11935	53	11506101	11645	65	12010974	18146	154	12085506	18918	183
11502811	11709	64	11506117	11535	64	12010975	18152	154	12085507	16965	183
11502812	11708	64	11506174	12693	51	12010996	15949	154	12085521	16513	182
11502843	12743	57	11507036	11644	65	12012000	14884	160	12085525	17109	181
11502873	12319	59	11507036	16269	65	12013813	13543	179	12085527	17109	181
11502941	12693	51	11508023	12322	51	12014012	14462	154	12085528	17109	181
11503284	17083	29	11508241	12575	109	12014836	14153	153	12085533	17199	183
11503289	17083	29	11508269	13614	54	12014837	14154	153	12085538	18917	181
11503317	11630	110	11508275	15330	64	12015024	18148	154	12089040	14150	153
11503394	12740	57	11508561	14051	55	120151	12546	174	12089188	14151	153
11503395	12741	57	11508654	15713	66	12015193	20618	153	12089189	13659	148
11503396	12742	58	11508797	12318	59	12015323	14152	153	12089189	19258	148
11503421	12213	4	11508879	14052	5	12015387	15923	154	12089190	13669	148
11503432	12117	66	11508900	12253	66	12015631	19795	419	12089190	19259	148
11503455	12667	110	11508905	12347	60	12015791	15950	154	12089191	13678	148
11503483	12742	58	11508927	13002	99	12015792	15952	154	12089191	19262	148
11503503	12097	57	11508930	15791	51	12015793	15954	154	12089305	15948	153
11503578	18261	57	11508987	14185	65	12015797	18145	154	12089306	18325	153
11503619	13613	53	11509189	12350	60	12015798	18147	154	12089340	16806	155
11503632	12336	53	11509371	12057	59	12015799	18151	154	12089507	14882	155
11503636	12213	4	11509374	12741	57	12015857	14881	156	12089649	14883	155
11503668	13705	54	11509511	11639	53	12015858	20216	156	12092344	20226	156
11503687	15310	61	11509535	15711	66	12015861	15938	156	12092345	20227	156
11503695	15335	64	11509589	11638	53	12015862	15948	153	12094429	20583	160
11503714	11864	109	11509816	12067	51	12015870	15945	157	12101855	18870	180
11503715	12575	109	11510062	12253	66	12015878	17002	153	12101856	18320	181
11503716	11864	109	11513798	20600	205	12015917	18324	153	12101857	18318	181
11503722	12108	66	11513801	12738	57	12015972	15952	154	12101859	18318	181
11503736	14980	66	11513864	12064	51	12015983	16941	419	12101869	18151	154
11503745	19205	65	11514282	15711	66	12020116	14880	156	12101880	18867	180
11503752	12595	575	11514290	16840	105	12020120	15939	156	12101885	19553	187
11503754	12596	64	11514343	11639	53	12020126	15944	157	12101895	17109	181
11503756	12596	64	11514518	11644	65	12020320	11948	155	12101897	16174	180
11503785	18261	57	11514596	11644	65	12020321	18650	155	12101898	16175	180
11503791	13715	51	11514623	12067	51	12020346	11947	155	12101903	17690	184
11503792	12345	52	11515478	12575	109	12020347	15935	155	12101906	16967	180
11503800	12324	51	11515566	18781	57	12020757	14883	155	12101909	17691	186
11503812	12064	51	11515614	19901	111	12020758	15925	155	12101914	18319	184
11503815	12322	51	11515757	13614	54	12027133	18923	179	12101917	13686	171
11503825	13618	52	11515893	12213	4	12033674	14150	153	12101927	19554	185
11503833	15788	52	11516148	18477	202	12033816	18649	155	12101933	18316	184
11503834	12065	52	11516150	11630	110	12033817	15960	155	12101937	17113	182
11503892	15373	58	11516150	12667	110	12034046	15947	156	12101939	18871	187
11503941	13617	51	11516372	20416	109	12034047	15946	156	12102568	17463	183
11503957	11864	109	11516397	20339	108	12034051	14151	153	12102620	16693	181
11503957	12669	109	11516596	13705	54	12034053	14882	155	12102621	14580	182
11503958	13715	51	11516780	15335	64	12034342	18149	154	12102747	17110	181
11503982	12066	52	11516942	13619	54	12040902	15924	155	12102748	18527	182
11504010	15721	57	11517293	12596	64	12040983	19851	419	12102757	19555	186
11504035	11627	110	11517343	12065	52	12040984	19440	419	12103360	20230	156
11504047	16842	109	11517517	12324	51	12043215	16694	181	12103881	15497	155
11504056	12738	57	11517706	13619	54	12045234	15927	175	12110649	20229	156
11504069	11937	55	11517769	20368	423	12045236	15926	175	12110652	20228	156
11504230	1943	3	11517803	16622	415	12045773	18653	155	12110842	20217	156
11504288	12667	110	11517873	20452	395	12046624	16693	181	12110843	20219	156
11504477	14950	55	11517992	20615	370	12047581	15498	155	12110844	20218	156
11504493	12323	52	11518017	20632	416	12047680	15497	155	12110845	20222	156
11504515	12352	60	11518091	20170	257	12047767	15499	155	12110846	20225	156
11504522	11939	55	11518121	12669	109	12048074	18654	155	12110847	20224	156
11504531	9879	105	11518201	20281	368	12048247	18655	157	12116958	17111	181
11504536	13002	99	11518357	20377	407	12048369	14918	180	12117353	18526	184
11504551	14569	55	11509030	20664	377	12048451	18660	156	12117354	19556	184
11504565	13619	54	11519031	20616	377	12052466	15500	155	12117361	17109	181
11504567	13614	54	11519444	20359	416	12052922	16806	155	12117375	18526	184
11504570	12067	51	11519952	20422	424	12065158	18150	154	12117384	13547	186
11504614	15327	64	11519960	20423	424	12066214	14881	156	12117385	17107	182
11504646	14572	55	11588988	20631	416	12066272	20208	155	12117387	18145	154
11504647	11943	55	1165051	19626	578	12066614	20231	157	12124075	20214	155
11504654	11941	55	1165051	19627	578	12076946	17175	179	12124076	20215	155
11504655	11944	55	117971	4417	322	12077140	18193	164	12124304	15938	156
11504656	11940	55	119005	16897	204	12077411	18657	156	12124515	8774	153
11504659	11938	55	1196781	3682	38	12083005	16585	179	12124580	15937	153
11504661	14049	55	12001470	13549	177	12083006	16586	179	12124581	18324	153
11504662	14046	5	12003757	13546	179	12083007	17108	177	12124582	15948	153
11504663	11945	55	12003758	13545	179	12083460	18924	177	12124587	18325	153
11504693	11626	109	12003759	12600	179	12083680	17172	180	12125637	11440	185
11504785	14047	55	12003878	13544	178	12083689	17173	180	12126032	12751	199
11504978	12666	109	12004005	12550	174	12084595	15948	153	12126451	18674	182
11504981	12068	60	12004007	12552	174	12084912	20209	157	12126452	15952	154
11504982	12343	54	12004009	12554	174	12084913	20210	157	12126460	19553	187
11505005	12596	64	12004010	12555	174	12085330	17174	180	12129373	20213	155
11505022	12351	59	12004035	15368	184	12085480	15368	184	12129409	20223	156
11505023	12339	60	12004188	19199	167	12085483	18916	180	12129484	20212	155
11505044	18416	52	12004201	8775	153	12085485	19882	183	12129493	18658	156
11505048	19144	109	12004311	12237	177	12085487	18872	184	12129497	18659	156
11505104	13712	56	12004475	18450	159	12085489	18315	184	12160374	20665	419
11505182	14053	55	12004610	14882	155	12085491	16968	183	12160551	20211	157
11505209	13618	52	12004996	15958	155	12085495	18868	181	12160857	20514	420
11505326	15790	53	12010031	15369	184	12085496	17114	180	12160858	20397	419
11505329	12595	575	12010085	15948	153	12085497	18524	181	12167116	18916	180
11505329	16268	64	12010182	15937	153	12085498	16694	181	12176844	19853	420
11505475	15323	64	12010293	18326	153	12085499	17197	182	12186456	20220	156
11505596	18338	109	12010300	15955	153	12085500	18529	182	12186457	20221	156
11505835	14050	55	12010717	15953	154	12085502	16964	183	1231490	10369	396
11505865	12108	66	12010973	15951	154	12085503	16514	182	12337852	14031	394

# O.E.M. INTERCHANGE BY MANUFACTURER

O.E.M. No.	Auveco No.	Page No.	O.E.M. No.	Auveco No.	Page No.	O.E.M. No.	Auveco No.	Page No.	O.E.M. No.	Auveco No.	Page No.
12337868	15518	425	14032291	14009	396	15607165	15970	380	1644290	18948	362
12337873	10054	108	14037239	18926	425	15612948	15970	380	16500308	14016	414
12337898	17341	341	14039420	14001	410	15613187	19375	66	16502342	20301	36
12337900	16953	419	14040999	16322	110	15614774	18244	254	16503329	14002	393
12337915	15490	242	14045480	14010	413	15622475	18507	393	16503548	14145	394
12337916	15783	26	14046480	12728	420	15622490	17615	251	16506582	17000	389
12337917	12669	109	14046514	12928	135	15632790	17508	423	16506617	19549	391
12337918	18928	392	14047034	12929	133	15638097	19222	421	16510893	15676	393
12337920	12737	379	14048060	13005	99	15638098	19221	421	16514113	14007	413
12337920	14524	379	14060613	12692	53	15638413	16938	378	16524431	18662	204
12337963	15455	330	14063981	13750	242	15641800	11110	27	1654047	11345	338
12337966	11630	110	14066728	17437	428	15646148	17343	427	1654048	11427	338
12338011	15467	341	14070914	13749	242	15648833	14988	441	1660123	11717	400
12338015	17437	428	14071289	14011	413	15650655	9880	105	16606936	17069	424
12338025	13009	99	14072598	15680	334	15653790	19781	426	16607593	14967	425
12338034	15453	329	14074081	14036	365	15659161	17072	372	16609280	19399	425
12338035	11417	353	14078435	11852	248	15660361	17345	428	16611887	18419	406
12338074	16936	429	14082956	18817	57	15672149	19242	411	16611888	18420	406
12338088	11943	55	14083173	14820	423	15672183	19782	426	16611889	18418	402
12338089	12594	400	14083901	14952	55	15672328	17599	381	16614134	18274	406
12338094	17125	53	14090382	19278	58	15672330	14998	412	16615006	19370	404
12338096	12824	401	14090908	16026	217	15672713	18167	249	16616138	19008	407
12338114	9112	127	14093088	14020	444	15676045	18933	412	16629990	19658	425
12338123	2775	4	14093869	14980	66	15678493	17215	371	16632192	16937	429
12338141	12659	24	14097279	16739	27	15681408	17103	414	16632193	16936	429
12338146	10052	108	14100784	17382	423	15682898	18262	422	16633853	17069	424
12338150	16719	409	14101262	15702	417	15685040	19424	427	16659131	20369	380
12338153	12658	249	14103026	12084	246	15685099	20415	423	16662182	19519	422
12353912	15463	340	14103026	17424	247	15686047	15792	26	16674629	20189	367
12354969	15948	153	14103435	16953	419	15686142	18153	422	16675980	19658	425
12354970	15937	153	14103438	15042	417	15690531	18744	241	16715497	17468	252
12355104	9481	152	14103461	15043	416	15690729	18977	397	16723225	12084	246
12355107	14150	153	142451	20292	203	15691493	16936	429	16723225	17427	247
12355107	14153	153	142452	16911	202	15691595	19424	427	1688094	11425	400
1244839	9965	578	142453	18015	202	15694099	18391	375	1689827	12095	29
12450143	20594	205	142454	16926	202	15704030	19515	253	1698296	11469	336
12450176	20595	204	142456	16923	202	15705372	11246	389	1703469	11417	353
1247872	15459	424	14250053	18001	202	15707256	19317	423	1706200	13828	401
12506127	18511	403	145525	14388	212	15709521	18262	422	1717924	15455	330
12519972	18429	402	1480627	8359	107	15715058	17654	243	1729250	11485	398
12519975	18417	402	1480909	8377	107	15731424	20414	53	1731225	11481	398
12530252	17654	243	1494015	10072	101	15732202	18028	242	1732326	12315	430
12533567	17103	414	1494252	8359	107	15733970	19614	397	174610	16146	577
12535713	19398	380	1494253	10830	108	15733971	19613	397	1746408	18817	57
12540326	19725	426	1494254	10054	108	15737532	12520	85	176653	16134	577
1254815	11838	393	1494257	10051	107	15737533	12522	85	17988147	16841	108
1255823	11865	395	1494258	8814	108	15745990	20527	397	17988488	14820	423
1257702	14217	420	1494258	10052	108	15745991	20529	397	17997722	14820	423
1260888	19166	106	15002519	19617	66	15748479	20268	422	1839906	18953	150
1261968	19664	54	15002520	18262	422	15748430	19616	422	193065	18474	202
1264963	12713	551	15006827	20345	369	15953247	15970	380	19630330	19389	403
127934	16910	202	15015804	18889	256	15953247	17649	380	20007308	17074	408
1304225	4249	328	15021761	20312	518	15954398	19429	395	20030401	15457	370
131282	16914	202	15022087	19395	257	15955172	13752	242	20032850	11679	363
1351769	9112	127	15025531	19616	422	15955523	17654	243	20037597	12314	430
1355003	9069	394	15026222	20158	475	15956062	18169	252	20043351	19183	427
1366042	16739	27	15026223	20157	475	15956470	14998	412	20043361	19183	427
1370853	12735	574	15028528	20159	475	15958694	11146	366	20046147	14559	427
1373789	10369	396	15029527	20161	478	15959832	18268	417	20046150	11816	399
1377030	10365	396	15029828	4369	328	15959833	18334	418	20057138	13437	209
14001841	16742	55	15031239	17654	243	15960325	18353	418	20058837	18398	408
14001842	16741	55	15046306	20619	422	15960621	19355	414	20059774	12333	53
14002811	13002	99	15056810	20362	368	15963179	16938	378	20064875	15456	370
14003784	16986	24	15076791	20444	377	15964971	16936	429	20067021	11802	399
14004876	12931	133	15149708	19639	415	15964972	16937	429	20085729	17073	343
14005089	11854	412	15153415	19615	416	15967691	19424	427	20095324	18399	358
14005097	16248	99	152266	8375	107	15969147	17216	416	20097200	12569	436
14007510	13231	98	152267	8372	108	15975244	19834	366	2011554	12084	246
14007510	13232	98	152273	15677	107	15986343	18371	365	2011554	17427	247
14007511	14976	98	15300530	19882	183	15986673	19356	378	20123070	15467	341
14007940	12999	97	15305932	18524	181	15989484	19388	418	20130258	13002	99
14008227	12210	133	15502538	8931	235	15989487	19387	418	20130258	13001	99
14011722	11109	27	15505451	16251	99	15990498	20451	424	20130258	13003	99
14013246	13960	394	15506827	14012	242	15993201	16622	415	20138524	12733	418
14017701	12930	133	1550971	18474	202	15994165	20542	415	20160591	15466	341
14017705	12923	134	15530810	16943	327	1600375	10759	390	20162174	17176	341
14017779	12947	135	15537954	17345	428	1605396	11146	366	20169887	12135	338
14017780	12924	134	15545178	18926	425	1605396	15414	366	20171942	12594	400
14019205	12567	413	15545202	15670	380	1606642	11657	390	20175051	12563	400
14019205	13996	415	15545202	15970	380	1606642	11659	391	20184399	12658	249
14019205	14753	411	15562609	16937	429	1610403	12917	134	20199675	14642	400
14019206	14007	413	15562610	17976	428	1614858	12931	133	20200750	18510	373
14019226	14011	413	15567924	15459	424	1617333	12919	134	20237057	12602	400
14021204	16208	388	15588024	13946	380	1618890	11470	390	2024778	18938	256
14022878	12621	400	15588078	14032	365	1618890	11657	390	2024781	8300	235
14023108	12925	134	15591860	19424	427	1618890	11659	391	20274997	12824	401
14025274	12916	134	15594416	14028	364	1619321	12137	368	20298365	11677	380
14027125	16944	327	15596279	14031	394	1619321	16263	368	20315425	12613	400
14027471	12759	369	15596280	14037	396	1621253	12935	133	20319841	12731	368
14029095	12940	135	15596301	13946	380	1622920	16247	99	20325696	12656	251
14031114	12926	134	15597271	14215	399	1623436	12998	97	20328600	15467	341
14031144	12916	134	15598757	15792	26	1631564	15478	368	20331307	12568	420
14031145	12932	135	15598845	17344	428	1635218	12999	97	20338568	13925	397
14031149	12941	134	15600382	10621	379	1636632	16624	415	20345137	14549	429
14031900	16880	65	15600382	12992	380	1638575	19162	106	20345381	15465	341
14032200	14008	409	15607139	18105	422	1640810					

# O.E.M. INTERCHANGE BY MANUFACTURER

O.E.M. No.	Auveco No.	Page No.	O.E.M. No.	Auveco No.	Page No.	O.E.M. No.	Auveco No.	Page No.	O.E.M. No.	Auveco No.	Page No.
20348200	12315	430	21011332	12254	66	22638717	13750	242	2852065	20156	475
20351035	12065	52	21021319	18749	254	22641917	18912	253	2962447	8774	153
20363491	13999	414	21030249	17216	416	22642007	19264	422	2962448	8777	153
20374473	12737	379	21035018	14031	394	22642199	19362	404	2962510	11440	185
20374473	14524	379	21035345	19297	413	22642756	20262	368	2962574	17001	153
20376243	4441	328	21039129	17975	371	22643056	18889	256	2962953	17115	159
20387349	19789	379	21039141	17215	371	22644361	19522	414	2962984	8775	153
20393536	14033	401	21042045	17218	375	22646099	19428	377	2962987	8776	153
20413107	11612	363	21042053	17218	375	22649878	11691	393	2965142	15957	153
20418416	13855	420	21042058	17218	375	22649879	11691	393	2965470	14892	159
20421672	13752	242	21042098	17214	411	22651066	18930	376	2965580	15504	159
20421800	12992	380	21042104	17218	375	22657634	19787	411	2965880	15503	157
20423550	15774	29	21047094	16816	414	22657634	19788	411	2971962	15956	153
20423647	13747	242	21075387	19101	51	22658182	19008	407	2973215	18690	155
20426301	14260	568	21075686	17222	414	22659122	19335	410	2973216	18651	155
20429451	13992	380	21077123	19801	415	22677979	20666	412	2973385	12751	199
20429500	14553	429	21077131	17616	418	22677980	20666	412	2973932	9905	177
20430956	13858	420	21077323	17226	414	22722859	20634	374	2974309	8756	178
20432601	14219	370	21077405	17227	412	22722860	20635	397	2977373	11442	186
20432975	13748	242	21093072	17637	256	230018	19943	481	2977373	13547	186
20433026	13753	242	21093588	17219	401	24100042	18663	219	2977607	11444	185
20444103	13458	401	21094146	16818	364	24100042	20372	219	2977615	17001	153
20448469	18430	403	21094240	18515	51	2419255	8905	235	2978302	8755	177
20451119	13457	410	21094747	17220	242	24205245	20528	362	2978302X	8755	177
20451401	13461	379	21095560	18881	109	24574578	18686	363	2984172	17117	159
20451401	15461	379	21095741	18880	109	2477054	8895	234	2984375	17116	159
20451401	16017	379	21095797	18896	416	2495701	8938	235	2984626	17117	159
20452072	12567	413	21097229	19854	414	25015169	12237	177	3000620	19257	566
20452072	13751	242	21097292	19902	421	2501569	12237	177	30008324	19243	410
20452072	13996	415	21098967	19397	340	25016383	11612	363	30012018	14696	513
20452072	14007	413	21110145	16816	414	25016383	11680	362	30066200	11642	64
20453400	12064	51	21170211	19909	420	25099299	20163	418	3065575	11796	380
20455900	14006	362	2201406	12522	85	25117765	18925	181	3065575	16261	380
20461373	13856	419	2201407	12520	85	25500454	18210	400	3072505	11839	394
20462090	16865	408	22049766	19068	344	25501771	12136	392	3078511	11130	371
20465395	14005	242	2207713	16132	577	25508532	12566	396	330485	19806	353
20467623	14222	399	22093245	17177	252	25512081	12729	421	332364	10831	365
20475949	14013	575	22098790	19085	347	25512688	19162	106	332364	16259	365
20475950	14014	573	22098842	19079	346	25514221	11675	363	342271	16253	99
20477732	16687	252	22189414	20360	367	25522466	9285	227	343543	11246	389
20477850	15464	341	22505958	12934	134	25524005	14004	242	343555	11243	389
20478294	13860	418	22508049	12932	135	25525798	14220	396	343555	11245	389
20478295	13456	419	22508050	12918	134	25526447	19435	396	343555	11246	389
20478733	15462	340	22508051	12937	133	25527289	14822	103	3455559	11253	392
20480475	13453	379	22508052	12927	135	25530441	14527	105	347065	16237	99
2048248	11673	368	22508803	11419	135	25535963	19472	419	347347	13450	393
20487630	15463	340	22511449	12945	135	25536302	14820	423	347893	11292	103
20491451	13826	420	22512114	12828	401	25543684	18459	404	3526573	19358	402
20493450	17455	341	22512276	12766	368	25551202	18946	254	3531990	18833	407
20510029	13993	415	22512276	16262	368	25552852	18422	404	3533539	16940	255
20511451	13454	363	22512857	12605	391	25552853	18423	404	3533539	19057	235
20514862	15367	363	22513813	12605	391	25552856	17979	402	3536964	18663	219
20538173	18302	362	22514578	14003	394	25554845	19361	398	3536964	20372	219
20547865	14147	417	22514924	14821	392	25556181	16929	65	3538281	19340	425
20556873	13857	420	22516030	20450	65	25556911	19166	106	3538469	18664	218
20558726	17435	428	22517337	11941	55	25600989	18459	404	3540146	17640	258
20561698	15155	65	22520368	16239	99	25601491	18174	364	3540146	18945	257
20565924	18678	418	22524005	14004	242	25603960	18389	362	3540161	16940	255
20570245	13994	417	22527147	18748	422	25604615	17548	398	3540161	19057	235
20582532	18392	425	22527720	14035	365	25605716	14527	105	354076	11246	389
20582533	18393	425	22529733	2293	104	25606274	19200	421	3540858	18308	416
20589218	13437	209	22529957	15992	395	25606388	18421	402	3543865	19369	422
20590899	13996	415	22531616	11631	111	25609048	17641	254	354400	12939	135
20590899	14753	411	22533245	16719	409	25618359	19433	409	3547221	20433	393
20603072	11152	337	22535007	15044	417	25618730	17121	254	3547382	18832	440
20606416	14945	399	22535311	16719	409	25630330	19389	403	3548011	17640	258
20606417	14946	399	22536642	18298	362	25630331	19411	403	3548011	18945	257
20612732	13746	242	22537749	14220	396	25630332	19412	404	3548690	17640	258
20624923	14014	573	22537990	11252	392	25632157	19542	395	3548690	18945	257
20626174	19394	342	22538004	14753	411	25633289	18422	404	3548693	19363	397
20632190	17666	408	22538004	14993	411	25640501	3138	102	3548804	18685	367
20635065	13994	417	22538102	14990	411	25642453	17103	414	357020	12918	134
2064891	10621	379	22539532	15465	341	25646858	19835	413	358501	8746	85
2064891	16260	379	22539533	15462	340	25647358	20584	394	362069	11638	53
20652520	18679	368	22542705	15045	417	25648693	20280	405	362379	11245	389
20664092	14753	411	22543363	17176	341	25649667	20466	396	363137	15461	379
20664092	14993	411	22543915	15715	65	25663903	20265	412	363137	16017	379
2067970	19041	241	22547243	15543	366	25672428	20279	380	365270	11718	390
20687704	16624	415	22550254	17545	398	25680782	14991	411	3655015	4233	328
20699808	14921	363	22566142	15684	248	25691949	20522	405	3664645	4237	327
20712176	15463	340	22566221	17106	414	25695687	19892	413	367291	14976	98
20713843	15684	248	22569178	18927	254	25696693	19759	377	367292	12995	97
20729447	18832	440	22578985	18911	397	25704001	20522	405	367292	12996	97
20730529	18427	403	22579423	18927	254	25704141	19758	377	3688699	8963	611
20731447	16886	64	22580569	18328	253	25707329	20244	418	3688811	4235	327
20734005	17092	380	22585836	18912	253	25718851	20326	406	3689084	4236	329
20743322	19808	253	22587036	18310	417	25722671	20318	405	3693292	4250	328
20747508	17341	341	22587341	12081	246	25762391	19758	377	3710401	9325	424
20747509	17159	341	22595587	14988	441	271022	10773	81	3711168	4265	327
2075380	19055	235	22599312	20263	401	274004	18472	202	371964	19824	111
2084421	8774	153	22600612	18930	376	274007	18473	202	3722635	2619	579
2085119	16940	255	22603044	19733	396	2793385	12751	199	3722635	12958	579
2085119	19057	235	22603384	19820	407	279670	12523	85	3744999	2752	579
2085823	19060	235	22607698	20357	378	279670L	12521	85	3744999	12960	579
21006725	18023	218	22615352	19732	396	279670R	12523	85	3745361	4280	327
21006951	18514	41	22637865	19360	404	279671	12521	85	3762180	4280	

# O.E.M. INTERCHANGE BY MANUFACTURER

O.E.M. No.	Auveco No.	Page No.	O.E.M. No.	Auveco No.	Page No.	O.E.M. No.	Auveco No.	Page No.	O.E.M. No.	Auveco No.	Page No.
3764554	9469	424	4723818	12961	579	7642589	13467	372	9422552	11292	103
3783002	5278	35	472434	11699	413	7693140	9639	337	94226492	14269	567
3783006	5228	38	472450	15453	329	7698976	9633	337	9424837	9880	105
3783794	5195	101	472812	12935	133	7724826	4447	328	9425491	9881	105
380370	8418	39	472814	12921	134	7730788	9749	337	9425542	16921	202
380382	9829	393	472815	12922	134	7731589	9850	400	9426331	12547	174
3816659	10649	215	4730773	20175	578	796255	11349	378	9426334	12545	174
3828472	18329	253	474821	14976	98	8717859	10243	338	9427587	18013	202
383569	8623	22	4755299	8435	38	8731909	3620	374	9427761	10666	103
383569	8624	22	4755299	11719	39	8731909	11120	362	9427882	9282	227
383569	8625	22	4759145	2943	578	8733059	10318	401	9427909	8925	235
3846202	15783	26	4761842	2943	578	8733059	11288	399	9427943	20289	203
3863669	8942	393	4767559	4446	328	8734067	10242	337	9428481	3796	103
3866846	15345	82	477418	12249	66	8799350	10617	400	9428902	16899	202
3876130	16240	99	4778814	2744	578	88891731	19424	427	9428902	19609	207
3893980	10330	393	4778814	2818	578	88891791	18889	256	9428904	16901	202
389809	13757	374	4778814	12962	578	88909769	12547	174	9428904	19610	207
3899596	14030	573	4779348	2943	578	88969790	20576	564	9431647	2293	104
3900684	4369	328	4801268	3620	374	88970345	20559	565	9431808	16913	202
3901067	19932	480	480534	10832	365	88970494	20577	569	9431809	18011	202
3907444	11719	39	4851794	9921	353	88970495	20578	554	9432137	16687	252
3919773	11691	393	4853108	8398	580	88986451	18868	181	9432552	16686	251
3920179	11352	421	4872948	4446	328	8900444	14752	185	94328493	17149	410
3921446	9851	391	4876498	10744	373	8900524	11948	155	9433040	18010	202
3921988	19130	218	4877000	8385	580	8901283	11166	177	9433043	11628	110
3923948	10090	392	4877001	8386	580	8902487	11446	178	9433143	20286	203
3927320	9481	152	4879431	9229	28	8903283	11446	178	94331546	20582	105
3944866	9965	578	4879481	8448	580	8903488	12629	164	9433155	9879	105
3944866	12971	578	4883164	8399	580	8903488	15372	164	9433156	20582	105
3946988	2710	1	4886720	8447	580	8903489	12628	164	9433159	16840	105
3963228	11738	134	490067	11770	23	8903489	15371	164	9433184	18016	202
3977775	11130	371	490067	11771	23	8904437	11156	178	9433185	17653	255
3977775	15456	370	5049604	19078	346	8905087	15959	155	9433186	18168	255
3982098	8359	107	513388	4243	327	8905794	20471	419	9433373	10171	1
3984469	10653	4	516637	8744	85	8909518	11156	178	9433489	11614	22
3985058	11424	393	52466047	19077	346	8909908	11446	178	9433489	11615	22
3986978	10727	396	52466089	19080	346	8911472	14546	419	94340505	17985	375
3986997	11109	27	528846	13004	99	8911473	14544	419	9434229	18732	235
3989067	15460	424	5297428	18952	150	8911497	14545	419	9436175	11620	248
3997391	14030	573	534343	11831	421	8911640	18648	155	9436175	16837	248
3998009	15759	425	545920	10401	106	8912698	11157	178	9436750	16922	202
4001934	13467	372	547944	4439	133	8912750	13540	177	9436789	18465	202
400764	4473	330	549790	11640	54	8913369	14885	160	9436790	20284	203
400765	4474	330	554343	11831	421	8914822	11475	179	9437173	18008	202
407217	11110	27	556196	11665	390	8914823	11476	178	9437486	12655	249
4081765	4188	327	556539	11667	391	8915135	12629	164	9437486	14486	249
409988	4417	322	556992	12932	135	8915136	12628	164	9437643	20402	249
411700	11721	362	557057	11655	390	8917225	18451	159	9437846	14486	249
411847	10827	394	557057	11871	391	8917283	17002	153	9437938	11621	249
4137121	4242	327	557057	12605	391	8917320	14547	419	9437938	16838	249
413851	11252	392	559312	11655	390	8917444	11083	167	9438068	18012	202
413945	8744	85	559312	11871	391	8917528	15959	155	9438068	19612	207
414187	11715	85	559547	11836	395	8918527	9883	177	9438150	11246	389
414188	19168	85	560625	12937	133	8918527	11166	177	9438848	16907	202
416629	12069	355	560692	11419	135	8919916	13543	179	9438850	16908	202
4179397	18840	137	562327	11831	421	90319187	19434	532	9439559	18749	254
4234830	15518	425	568792	19626	578	91171148	18661	205	9439702	20290	203
4417599	8447	580	568792	19627	578	9117148	20601	205	9439719	12657	255
444613	9278	227	574355	19626	578	91173701	15926	175	9440034	15511	27
444619	9279	227	574355	19627	578	91176726	20417	407	9440178	9879	105
444620	9279	227	575411	2789	579	916581	9884	187	9440375	17409	247
444667	9285	227	575411	12961	579	916581	9885	187	9441592	18167	249
444776	9283	227	588546	15037	28	916632	9916	187	9441721	18009	202
444777	9283	227	5949838	3178	392	916638	9884	187	9441724	20598	205
444782	9284	227	5963268	11156	178	916638	9885	187	9441725	12083	246
444789	9285	227	5970995	16230	97	94051993	16859	546	9441731	16896	204
445429	11292	103	5973400	12757	413	9411017	9265	223	9441732	16897	204
4457495	10220	399	5973823	19847	413	9411019	9266	223	9441733	16898	204
4457595	10220	399	5973996	12756	414	9411022	9257	222	9441770	8938	235
4459049	9342	359	5973996	15042	417	9411031	9260	222	9441837	18017	202
4490167	9477	409	6263345	11138	398	94113207	17271	395	9441838	18000	202
4492962	10318	401	6264396	16246	99	94145515	17076	518	9441839	16915	202
4492962	11288	399	6270163	10832	365	9414716	3079	3	9441840	16916	202
4495047	9367	424	6271989	14559	427	9414722	1943	3	9441854	17998	202
4533699	8583	337	6272766	12918	134	9414723	2808	3	9441866	17999	202
454626	16919	202	6280765	3617	359	9414767	2734	1	9441923	18018	202
454645	16925	202	6288704	8777	153	9415465	2366	3	9441941	2808	3
454646	18004	202	6292995	15372	164	9416042	2712	1	9441955	19796	258
455136	16920	202	6292996	15371	164	9416444	2709	1	9441956	18005	202
455490	16918	202	6292997	18773	164	9416927	16909	202	9442003	17996	202
4563173	4240	329	6293702	15370	164	9417276	1937	3	9442081	17997	202
4564974	4264	328	6293923	16935	164	9417561	20285	203	9442361	17641	254
4565415	4240	329	6294493	12564	153	9417863	16906	202	9442468	17431	254
458030	12316	430	6294493	13548	186	9417866	16904	202	9442486	18001	202
4637277	20175	578	6294511	15936	155	9417866	19608	207	9442492	18478	202
4653672	3445	352	6294512	11947	155	9419740	5655	2	9442876	20594	205
4654974	18397	352	6298886	9883	177	94198687	14697	513	9442876	20596	205
4657731	2628	338	6298886	11166	177	9420052	12097	57	9442880	20597	204
465994	12945	135	6298886	13558	177	9420262	10669	83	9442881	20599	205
4676189	19807	579	6298892	9883	177	9420850	11923	3	94467458	17355	517
4689929	2744	578	6298892	13558	177	9421330	16902	202	94841226	14750	572
4689929	2818	578	6298935	9883	177	9421330	19611	207	94842841	18297	563
4689929	12962	578	6299087	11157	178	9421777	16912	202	94847334	17383	412
4699315	2619	579	6466355	12920	134	94218027	17195	499	94848189	18330	373
4721222	4281	329	7634583	9275	337	94221150	14727	548	94848192	18330	373
4723818	2789	579	7637192	4441	328	9422339	18469	202	94848834	15695	553



# O.E.M. INTERCHANGE BY MANUFACTURER

O.E.M. No.	Auveco No.	Page No.	O.E.M. No.	Auveco No.	Page No.	O.E.M. No.	Auveco No.	Page No.	O.E.M. No.	Auveco No.	Page No.
<b>MARSON</b>			9991-00-403	14364	524	MB566720	19334	538	62318-01W00	16860	546
HP-2	7915	236	9991-00-412	13930	541	MB608104	19129	568	62319-0W000	20266	541
HP-30A	7982	236	9991-00-501	14357	524	MB608134	19342	535	62350-01M00	14729	546
HP-30B	7983	236	9991-00-503	14313	524	MB608137	19343	535	62350-M7060	14729	546
HP-30C	7984	236	9991-00-601	14274	506	MB608140	19330	536	62380-U7400	17196	543
HP-30D	7985	236	<b>MERCEDES-BENZ</b>			MB608156	19475	535	62660-48600-1	20381	508
HP-30N	7981	236	000-987-10-15	13148	532	MB692000	19321	538	62698-V7000	14313	524
53130	12657	255	000-987-10-81	13157	531	MB696120	19320	538	62869-N4700	14723	544
53181	12654	256	000-987-15-81	13141	531	MB814419	19314	535	63844-01A00	16858	547
<b>MAZDA</b>			000-988-16-25	20647	531	MB869072	19331	537	63844-01A99	14726	546
BC1D-56-145	19315	528	000-988-23-78	13145	532	MB880455	19745	535	63844-D0100	14727	548
BF67-50-033	15366	528	000-988-55-81	13144	531	MB887567	17351	538	63848-01G00	16782	513
BF67-50-235	17450	528	000-988-56-71	13153	530	MB888561	19324	537	63848-35F00	19735	549
BF82-50-233	16843	548	000-988-86-25	20404	531	MC440901	20381	508	63848-40Y00	20613	547
BW0A-50-792	19138	525	000-990-03-92	13230	532	MD050317	19007	217	63848-9E001	20327	547
B001-68-302-00	16777	563	000-990-21-92	13142	530	MR138807	18951	539	63848-D0100	17193	549
B003-68-865-96	17453	526	000-990-22-92	13230	532	MR154127	19473	535	63848-D4000	17385	549
B092-50-609	17290	523	000-990-25-92	19434	532	MR154128	19474	535	63848-D4001	17385	549
B092-50-715	17195	499	000-990-34-92	20187	532	MR201466	19328	539	63854-01A00	17472	547
B092-51-833	17632	527	000-990-37-92	20314	532	MR478262	20580	538	63876-95596	16000	514
B100-68-695	14708	526	000-990-40-92	20640	532	MR478263	20581	537	63878-01E10	20348	547
B101-68-252-00	17478	527	000-990-44-92	20639	532	MS480001	14255	506	65624-V0100	14337	548
B173-50-852A	19451	522	000-990-46-92	20641	532	MS480002	13932	559	65810-K2000	19724	545
B252-51-PJ5A	19906	526	000-990-57-92	20642	532	MS480009	13932	559	65832-F5000	17237	544
B455-56-741	18458	525	000-994-04-45	13224	534	MS480012	14695	507	65846-30F00	17237	544
EA01-50-048	18882	522	000-994-06-45	13218	534	MS480013	19239	512	65846-40F00	19468	517
FB01-56-964	16000	514	000-994-09-45	13220	534	MU435004	16254	99	66814-01G00	16725	548
FD02-50-798	20579	524	000-994-13-45	13152	533	MU480034	19322	536	66820-3S500-C1	20672	545
GA2A-56-399A	19753	525	000-994-14-45	13215	534	MU481027	19325	538	66820-3S510	20614	540
GA2A-56-694	14709	526	000-994-14-45	13216	498	MU481187	19323	537	66820-88E00	17633	543
GA2A-58-762	19481	527	000-994-25-45	13223	533	MU840004	15931	175	66824-01G00	16783	546
GA2A-68-AB1A	20459	527	000-994-50-45	13222	498	MU840015	15926	175	66824-W1000	14725	548
GA5R-56-392	19306	527	000-997-91-86	20643	532	MU840016	15927	175	66860-01W01	16859	546
GA976-1391	14714	528	001-988-12-25	20646	531	MU840021	15931	175	68425-H5000	14313	524
GJ21-50-034	17060	528	001-988-20-81	16124	531	106212	14335	542	72727-W1000	15470	540
GJ21-50-049	17003	448	001-988-20-81	20205	531	480001	14255	506	72774-01F00	14331	541
GJ21-50-H81	17551	525	001-988-29-81	20204	531	<b>NISSAN</b>			72826-01P00	15468	540
GJ21-50-H82	17552	525	001-988-31-81	20239	530	01241-00551	17193	549	73856-51E00	17348	540
GJ21-51-036	16555	522	001-988-31-81	20239	530	01281-00022	14331	541	74798-S9000	14695	507
GJ21-51-047A	16550	522	001-988-49-81	20238	530	01281-00023	14275	560	76848-35F00	19685	542
GJ21-58-502A	19743	525	001-988-51-81	20198	530	01281-00151	14335	542	76848-35F20	20168	542
GJ21-68885-B69	18206	527	001-988-76-81	20205	531	01281-00151	14335	542	76848-50Y00	20257	542
G030-68-885-B-38	14709	526	001-988-77-81	20200	531	01281-00231	14275	560	76876-W5000	14352	543
G031-58-762	18692	564	001-990-00-91	20651	534	01281-00231	14695	507	76881-0P000	20166	543
G043-50-742	20460	526	002-994-65-45	20235	530	01281-00441	17342	541	76881-9E000	19897	541
G219-51-081	19469	522	003-988-19-78	20644	532	01281-00481	19146	543	76882-0B000	19432	546
G350-68-AB1	18824	526	003-988-41-78	20188	532	01281-00501	19292	543	76882-0B005	19432	546
HA01-50-609	14717	523	003-994-30-45	13218	534	01281-00601	19293	542	76882-57A00	18265	546
HG30-50-6B9A	19648	523	004-988-76-78	20657	530	01281-00711	20604	542	76884-91000	12583	544
H001-50-609	14719	523	004-988-77-78	20657	530	01281-00741	20258	542	76906-T3000	14353	540
H001-50-841	14695	507	006-988-30-78	20201	530	01553-00051	14356	544	76988-3J000	19736	543
H001-68-719B	17451	525	006-988-35-78	20199	530	01553-00172	14737	563	76996-01P02	16776	509
H115-67-099	15926	175	006-988-72-78	20236	530	01553-00202	14347	544	76997-P7100	14723	544
H116-67-099	15927	175	123-401-01-28	13149	534	01553-00291	14349	543	78856-R4301	14690	507
H117-67-099	15931	175	123-990-00-92	20636	533	01553-00291	14355	543	79796-F1E00	17349	540
H260-50-6K8	19833	524	123-990-01-92	17668	530	01553-00401	14355	543	79896-P7100	14333	540
JOY1-50-619C	19452	523	123-990-02-92	20637	533	01553-0052U	20671	544	80866-01A00	16822	540
KA01-50-H15A	17554	525	123-994-01-45	20648	533	01553-00545	17452	543	80874-0P000	20673	542
KA01-50-H16	17553	525	123-994-03-45	20652	533	01553-01121	17452	543	80875-85E00	18166	545
KA78-50-AF4	19748	524	123-994-08-45	20650	534	01553-01182	20256	544	80897-10Y00	19738	546
KA80-51-RF5A	18822	522	124-990-05-92-9051	20640	532	01553-01393	16843	548	80999-05N07	16784	570
LA01-50-6A8A	19831	523	124-990-07-92-9C75	20203	533	01553-01781	17634	543	82520-E6000	14336	546
LA01-56-135	14750	572	140-698-00-82	20656	531	01553-02041	20167	544	84653-N7400	14337	548
LB82-50-669A	19755	523	201-988-03-78	16123	530	01553-02741	17378	548	84915-0W000	19731	545
LB84-68-AD5	19832	524	201-988-04-78	20202	530	01553-02821	20670	545	85099-0B720	19293	542
NA01-50-101A	19228	522	201-988-06-78	20658	530	01553-03101	17378	548	85284-AD005	20674	540
NA01-56-145	16858	547	201-988-07-78	20197	530	01553-06161	19367	546	89427-98070	16775	509
N304-13-356-A	14697	513	201-988-25-78	20644	532	01553-06721	17347	548	92470-N8200	18135	321
S084-58-502	20463	525	201-990-00-50	20645	533	01553-07111	20669	545	92470-N8210	18135	321
T001-50-M48B	19450	522	201-990-02-92	20638	533	01553-08911	19750	540	92471-N8200	18139	321
UB39-45-919	20465	527	201-997-22-81	20659	531	01553-09241	19246	547	92472-N8200	18134	321
UB39-50-795	19747	527	673-988-00-25	20315	531	01553-09311	19684	545	92473-N8200	18142	321
UB42-67-013	19754	529	<b>MITSUBISHI</b>			01553-09321	19274	547	92474-N8200	18138	321
0483-66-061-A	14358	524	AA-000000	14735	571	01553-09601	20185	547	92475-W1000	18140	321
1243-50-609	12591	523	AB009006	16898	204	01553-09611	20349	547	92475-W2100	18144	321
1395-68-676	14369	528	HB-121467	14720	537	01553-09791	20668	545	96706-89901	14366	542
8133-50-022	14380	526	MB020923	19385	537	01553-10051	19905	547	96706-B0700	13930	541
8173-50-931	12589	523	MB023930	14366	542	01553-S3500	13945	545	96706-B6700	13930	541
8545-50-786	14362	524	MB029111	14277	560	01553-S3500A	13945	545	96706-H2500	14724	542
9924-90-512B	14367	525	MB029111	14277	560	01651-00481	14695	507	96706-H9400	14335	542
9926-40-531B	18271										





# O.E.M. INTERCHANGE BY NUMERICAL ORDER

The O.E.M. numbers listed in this interchange are cross referenced to the closest equivalent Auveco part. In some instances, the parts are not identically the same. There may be slight differences in the finished, length, washer O.D.: however, the Auveco part is designed to serve the same application.

This interchange is not listed in strict numerical order (from the lowest number to the highest number.) Rather it is arranged in numerically ascending order from the left regardless of the number of digits in each O.E.M. number. Thus every number that begins with a 1 is listed before any number that begins with a 2. You should key on the first four digits to locate the number. For example, 1121865 is located before 11229 and after 11189734. OEM numbers that begin with a letter precede OEM numbers that begin with a numeral.

O.E.M. No.	Auveco No.	Page No.	O.E.M. No.	Auveco No.	Page No.	O.E.M. No.	Auveco No.	Page No.	O.E.M. No.	Auveco No.	Page No.
AA-000000	14735	571	D2AZ-6522008-A	18892	451	E0TB-1063-226-AC	16213	388	E8EB-14474-AMA	16805	158
AB009006	16898	204	D2FZ-6222600-A	12470	452	E0VE9K319-AB	12938	134	E8EB-14474-VA	16348	158
AB-181-GG	16893	52	D2KB-13021-AA	12227	434	E0VY-13A506-A	17164	446	E8EB-14488-UA	18412	157
A20Z-13410B	13537	188	D20B-13A093-AA	11660	433	E1EB-61046A48-BA	12606	448	E8FZ-13032-A	16396	432
BC1D-56-145	19315	528	D20B-13A093-AA	11661	433	E1EZ-9E499-EA	18835	134	E8FZ-13032-B	16397	432
BF67-50-033	15366	528	D2OZ-14474-F	16805	158	E1VY-14474-B	16345	158	E8FZ-5802354-A	19845	369
BF67-50-235	17450	528	D2OZ-5323394-A	20685	344	E1VY-6623394-A	19071	344	E8OY-5423394-B	20686	344
BF82-50-233	16843	548	D2OZ-5323395-A	20686	344	E1ZE-9E499-CA	18836	135	E8OY-5423395-B	20685	344
BOA-13713	13435	209	D2SB-65045A28-AA	12610	439	E1ZE-9E499-EA	18835	134	E8TZ-9823394-A	20685	344
BSS800	12654	256	D2SZ-65045A28-B	12610	439	E25Y-14421-C	16342	158	E92Z-13032-B	17457	433
BW0A-50-792	19138	525	D2VZ-6521952-A	14967	425	E25Y-14421-CA	16342	158	E92Z-17C756-C	17060	528
B001-68-302-00	16777	563	D3AA-90826-AA	10837	447	E27B-1063226-AC	16214	388	E97B-13A093BA	16399	432
B003-68-865-96	17453	526	D3AB-14474-DA	14889	158	E27B-14474-BA	18854	158	E97B-13A093-BB	16399	432
B092-50-609	17290	523	D3AZ-13410-A	13535	188	E2EB-6120C62-AA	19154	438	E9AZ-5422008-A	18890	451
B092-50-715	17195	499	D3AZ-13410-B	13533	188	E2EB-61290C62-AA	19154	438	E9DB-13N020AA	15940	434
B092-51-833	17632	527	D3AZ-13410-E	14131	189	E2GZ-6723342-A	13030	452	E9DZ-13N129-A	15940	434
B100-68-695	14708	526	D3AZ-13410-G	14132	189	E35Y-13466-A	20294	203	E9DZ-6734B	18299	217
B101-68-252-00	17478	527	D3AZ-14526-D	12629	164	E35Y-13466-B	18012	202	E9FZ-5822008-A	18891	451
B173-50-652A	19451	522	D3AZ-14526-E	15372	164	E3AZ-5423394-A	20685	344	E9SB-13N019-BA	16425	435
B252-51-PJ5A	19906	526	D3AZ-14526-E	12628	164	E3AZ-5423395-A	20686	344	E9SB-6302354-ACW	15523	367
B455-56-741	18458	525	D3AZ-14526-E	15371	164	E3AZ-5423395-ARM	20686	344	E9SC-2B223AA	15524	446
B5A-10756-B	8964	611	D3AZ-14526-H	12628	164	E3MY-13466-A	18006	202	E9SZ-13N019-B	16425	435
B7A-16758-A	4273	328	D3AZ-14526-J	12629	164	E3SB-6342413-AB	13564	339	E9SZ-13N021-A	16898	204
B8AZ-13466-A	16919	202	D3AZ-14526-Z	12627	164	E3TB-1063-226AA	16213	388	E9SZ-13N021-B	16897	204
B9MF-13713A	13435	209	D3AZ-5723394-A	20685	344	E3TZ-9843052-A	19167	450	E9SZ-63030A12-A	19780	335
C0AZ-1012-A	8744	85	D3AZ-5723394-B	20685	344	E3VB14461AA	18853	158	E9SZ-6323394-A	20685	344
C1AB-6220807-A	3639	374	D3AZ-5723395-A	20686	344	E3VB-144861-AA	18853	158	E9SZ-6323395-A	20686	344
C15F-14474-A	15504	159	D3AZ-5723395-B	20686	344	E3VB-14488-AA	18852	158	E9TZ-6730-B	19365	221
C2AZ-13466-C	16902	202	D3AZ-5723395-ARM	20686	344	E43Z-5423394-A	20685	344	E9WB-13A093BA	16405	432
C2AZ-13466-C	19611	207	D3AZ-6523394-A	20685	344	E43Z-5423395-A	20686	344	E9WB-13A093CA	16406	432
C2OZ-13031-A	10716	435	D3AZ-6523395-A	20686	344	E4FZ-14474-AA	18408	157	E9WY-13032B	16405	432
C2TB-14462-A	17115	159	D3AZ-9823395-A	20686	344	E4FZ-8C290-A	17619	193	E9WY-13032C	16406	432
C3AZ-13466-D	20285	203	D3OZ-16776-A	11136	374	E5AZ-13466-A	18476	202	FB01-56-964	16000	514
C3AZ-13713A	13435	209	D42B-6021066-BA	14213	439	E5LB-13A147AA	15814	434	FD02-50-798	20579	524
C3DZ-13466-A	16904	202	D4AZ-13466-A	18465	202	E5LY-13A147-A	15814	434	FDA13021-A	12228	434
C3DZ-13466-A	19608	207	D4LY-13410-A	14133	189	E5LY-13N021-A	16896	204	F03Z-13032-A	16733	432
C5AB-14474-B	14892	159	D4MY-13466-A	18011	202	E5TZ-1023394-A	20685	344	F09Z-1123394-A	20685	344
C5AB-6220586-A	8853	373	D4OZ-13234-A	14128	189	E5TZ-1023395-A	20686	344	F09Z-1123395-A	20686	344
C5AZ-6243720-B	4750	326	D4ZT-13234-A	14130	189	E5ZZ-12A209-A	18217	192	F09Z-1123394-ARM	20685	344
C5Z-6543413-B	8941	339	D5HZ-14461-A	18411	157	E6AZ-5421952-A	15675	450	F0TZ-14489-J	19004	195
C6OZ-16758-A	4357	328	D5UB-2221066-AA	12559	439	E6DC-2B223AA	15524	446	F1CZ-13466-C	20595	204
C6AB-6242413-A	9353	339	D5ZZ-16828-A	17338	447	E6DZ-13032-A	15968	431	F1CZ-13A147-A	18899	434
C7AB-14A163-B	9426	446	D6EA-1A100-AA	11702	443	E6DZ-13032-B	15969	431	F1CZ-16774-A	18458	525
C7SZ-13466-B	16921	202	D70B-13A093-AA	11662	433	E6DZ-13466-B	18005	202	F1CZ-5802316-A	19138	525
C8OZ-13711-A	12237	177	D7OZ-13032-B	11662	433	E6DZ-13K040-B	15634	433	F1CZ-61101B04-A	17602	440
C8AB-13713-A	13438	209	D7OZ-13410-A	14136	188	E6DZ-14A411-A	18676	191	F1CZ-8A188-A	17317	437
C8AB-14463-D	17116	159	D7SZ-13032A	11662	433	E6DZ-5421952A	17122	450	F1TZ-1023394-A	20685	344
C8AB-14463-M	18451	159	D7TZ-13466-A	18008	202	E6DZ-5421970-A	17119	450	F1TZ-1023395-A	20686	344
C8AB-14463-N	17117	159	D7VY-6050074-A	13966	551	E6DZ-5421971-A	17118	450	F1TZ-17698-A	19393	342
C8AZ-13713-A	13438	209	D7WY-6523394-A	20685	344	E6FZ-13466-B	18016	202	F1TZ-7810182-A	19441	439
C8AZ-13713-B	13438	209	D7WY-6523395-A	20686	344	E7EB-14421-EA	16342	158	F1TZ-7823394-A	20685	344
C8AZ-63442413-A	9882	339	D8BB-13M093-AA	11869	433	E7EB-14461-BA	20475	157	F1TZ-7823395-A	20686	344
C8AZ-63642413-A	9882	339	D8BB-13M093-AA	11870	433	E7EB-14474-CA	16344	158	F1ZZ-13466-A	20286	203
C8OZ-13713-A	13438	209	D8BB-14474-BA	14889	158	E7EB-14487-AA	18408	157	F155EK1	14961	460
C8TZ-13466-A	16899	202	D8BB-7420828-AA	14137	439	E7GZ-17A904-B	15366	528	F155GL7	14965	460
C8TZ-13466-A	19609	207	D8BZ-13032-A	11869	433	E7GZ-6120586-B	18692	564	F155GR8	14966	460
C9OZ-13713-A	13438	209	D8BZ-13032-B	11870	433	E7SB-13A093AA	15965	432	F2AB-5410182-AB	17066	439
C9AZ-13713-A	13438	209	D8BZ-13032-B	11869	433	E7SB-13A093BA	15966	432	F2AZ-5426448-A	19659	336
C9AZ-62234A24-B	17257	343	D8BZ-13032-B	11870	433	F7SZ-13032-C	15965	432	F2DZ-13466-C	20599	205
C9MY-13713-A	13438	209	D8BZ-13466-A	16922	202	F7SZ-13032-D	15966	432	F2PZ-14A464-C	19004	195
C9OB-13713-A	13438	209	D8BZ-14474-A	14889	158	E7SZ-6323394-A	20686	344	F2SZ-14570-A	19426	452
DITZ-13032-B	11662	433	D8BZ-5423342-A	13030	452	E7SZ-6323395-A	20685	344	F2TZ-13K040-A	19192	431
DOAZ-5323395-A	20686	344	D8TZ-13466-A	18472	202	E7TB-13A093-AB	16402	432	F2UZ-1602354-AAA	19846	369
DOZ-6203174-C	10625	339	D8TZ-9823394-A	20685	344	E7TZ-1023394-A	20685	344	F2ZZ-14474-A	16346	158
D0AZ-5323394-A	20685	344	D8UZ-19805-A	19081	346	E7TZ-1023395-A	20686	344	F2ZZ-16774-A	14709	526
D0AZ-5723394-A	20685	344	D9OZ-6522841A	14551	451	E7TZ-13032-A	16402	432	F3DZ-6734-A	18299	217
D0AZ-5723395-A	20686	344	D9AB14A163JC	12622	446	E7ZB-6120908AC	15812	439	F3LY-14570-B	17222	414
D0AZ-62234A24-B	17257	343	D9AB-74519B18-AA	14758	380	E7ZZ-13466-B	18007	202	F3LY-6321970-A	17119	450
D0AZ-62234A24-B	17974	343	D9AE-9E645-AA	12921	134	E804-14526A	15926	175	F3LY-6321971-A	17118	450
D0DZ-15A434-B	9883	177	D9AZ-14474-F	16344	158	E804-14526B	15927	175	F3XY-12044A59-A	18667	442
D0ZB-13A-093-AA	11660	433	D9AZ-14A163-J	12622	446	E804-14526D	15931	175	F3XY-12044A59-C	18667	442
D1AB-13713-A	13438	209	D9AZ-54234A46-AA	19193	336	E83B-13A093-AA	16733	432	F3ZZ-17C756-S	17003	448
D1AB-14461-AA	14887	157	D9BZ-3623394-A	20685	344	E83Z-16758-A	16832	331	F37Z-13032-A	18739	431
D1AB-6542413-AB	9882	339	D9BZ-3623395-A	20686	344	E83Z-16828-A	16992	447	F37Z-13N129-A	18263	434
D1AZ-13410-A	19813	195	D9BZ-5401316-B	14768	435	E83Z-5421952-B	17122	450	F4CZ-13466-A	16917	202
D1AZ-13410-B	13537	188	D9BZ-5402316-B	14768	435	E8AZ-13466-A	17996	202	F4PZ-14A411-C	19885	196
D1AZ-13713-C	13438	209	D9BZ-5423394-A	20685	344	E8BZ-17C756-C	17450	528	F4TZ-13N021-B	18662	204
D1AZ-6522841-A	14550	429	D9BZ-5423395-A	20686	344	E8EB-13A093-AA	16396	432	F4UB-14A464-A	19004	195
D1AZ-6542413-B	9882	339	D9ZB-13A093AA	12609							

# O.E.M. INTERCHANGE BY NUMERICAL ORDER

O.E.M. No.	Auveco No.	Page No.	O.E.M. No.	Auveco No.	Page No.	O.E.M. No.	Auveco No.	Page No.	O.E.M. No.	Auveco No.	Page No.
F5DZ-13466-B	17966	202	MB106212	14335	542	N621940	15335	64	N805083-C	16832	331
F5RZ-17K657-A	20425	436	MB132008	14335	542	N621942-S301	15337	64	N805155-S	17124	375
F5RZ-5421416-B	19281	435	MB153825	17195	499	N623330-S2	18337	108	N805229-S	14988	441
F5TZ-6734-BA	20453	217	MB198536	17295	535	N623331-S2	18338	109	N805231S	15522	443
F54Y-13466-A	19209	205	MB253964	17351	538	N623332-S100	12669	109	N805315	17381	370
F57Z-16241-AB	20663	439	MB271999	20565	537	N623332-S2	12669	109	N805592-S100	17121	254
F57Z-7810182-AAA	19441	439	MB325299	16671	572	N623332-S53	12669	109	N805612-S	17102	375
F58Z-16237A02-A	18848	375	MB358818	15926	175	N623333-S100	11629	110	N805612-S100	17102	375
F58Z-16828-A	16992	447	MB358819	15927	175	N623333-S2	11629	110	N805759-S100	16834	251
F6DZ-5402316-AA	19238	437	MB361578	19329	537	N623334-S426	20447	111	N805889-S100	19480	110
F6DZ-5410182-AA	20358	439	MB383455	14331	541	N623340-S2	11625	108	N805995-S100	18331	257
F6TZ-6730-BA	19279	220	MB417490	19332	537	N623343-S100	11630	110	N806090-S100	17409	247
F65Z-15020C34-AA	19536	447	MB419858	19487	536	N623343-S2	11630	110	N806113-S	20189	367
F65Z-15020X34-AA	19536	447	MB455-56143	17632	527	N623344-S2	18339	111	N806126-S100	17408	250
F7CZ-17C756-BA	20336	437	MB547806	17472	547	N800312-S2	15776	59	N806289-S	17339	372
F7DZ-5402316-AA	19238	437	MB566719	19802	374	N800322-S55	18523	57	N806322-S	18893	442
F7UZ-1513284-BA	19421	449	MB566720	19334	538	N800369	16422	35	N806334-S	20245	436
F7UZ-15238A32-AAC	19413	357	MB567798	19814	457	N800369-S2	16421	35	N806340-S	19850	373
F75Z-13N129-AA	19180	434	MB608104	19129	568	N800387-S	11842	370	N806344-S	18275	369
F75Z-6730-BA	19773	220	MB608134	19342	535	N800466	15325	64	N806345-S433	14947	98
F8DZ-54265A99-AA	20630	450	MB608137	19343	535	N800484-S58	16736	1	N806345-S47	14947	98
F85Z-1521952-BB	19651	450	MB608140	19330	536	N800485-S58	16737	1	N806363-S	20264	437
GA2A-56-399A	19753	525	MB608156	19475	535	N800503-S	11841	436	N806511-S32	19823	448
GA2A-56-694	14709	526	MB692000	19321	538	N800510-S100	20176	51	N806537	17063	449
GA2A-58-762	19481	527	MB696120	19320	538	N800540-S100	20176	51	N806577-S	19267	436
GA2A-68-AB1A	20459	527	MB814419	19314	535	N800883-S100	17187	24	N806624-S191	18102	448
GA5R-56-392	19306	527	MB869072	19331	537	N800928-S45	14947	98	N806685-S900	19457	256
GA976-1391	14714	528	MB880455	19745	535	N800947-S	16893	52	N806795-S	19634	437
GJ21-50-034	17060	528	MB887567	17351	538	N801078-S58	16361	53	N806830-S100	17369	257
GJ21-50-049	17003	448	MB888561	19324	537	N801117-S100	18401	111	N806830-S100	19263	257
GJ21-50-H81	17551	525	MB888869	19140	569	N801310	15317	64	N806959-S	19235	321
GJ21-50-H82	17552	525	MC440901	20381	508	N801638-S43	12651	254	N807125-S100	17409	247
GJ21-51-036	16555	522	MD050317	19007	217	N801706-S	12569	436	N807154-S	19371	366
GJ21-51-047A	16550	522	MNA01-56145	16858	547	N801829-S100	12610	439	N807154-S	19372	366
GJ21-58-502A	19743	525	MR138807	18951	539	N801851-S45	14947	98	N807154-S	19373	366
GJ21-68885-B69	18206	527	MR154127	19473	535	N801925-S	12565	374	N807155-S	19352	365
G030-68-885-B-38	14709	526	MR154128	19474	535	N801994-S100	19667	363	N807155-S	19354	365
G031-58-762	18692	564	MR200300	20247	538	N802073	15319	64	N807168-S	19111	255
G043-50-742	20460	526	MR201466	19328	539	N802081-S100	16932	24	N807189-S100	20171	437
G219-51-081	19469	522	MR478262	20580	538	N802190-S53	17613	448	N807247-S	19526	438
G350-68-AB1	18824	526	MR478263	20581	537	N802190-S53B	17613	448	N807389-S	17216	416
HA01-50-609	14717	523	MS480001	14255	506	N802239-S	17643	446	N807455-S100	18879	449
HB-121467	14720	537	MS480002	13932	559	N802241-S	17642	447	N807535-S	19760	367
HB2-12V60W55W	18661	205	MS480009	13932	559	N802331-S53	16842	109	N807535-S	19761	367
HB2-12V60W55W	20601	205	MS480012	14695	507	N802376-S	14754	436	N807535-S	19762	367
HG30-50-6B9A	19648	523	MS820959	16897	204	N802538-S100	14526	105	N807577-S	18895	442
HP-2	7915	236	MU000319	19239	512	N802734-S	15480	367	N807578-S	18894	442
HP-30A	7982	236	MU435004	16254	99	N802734-S	19197	367	N807620-S100	18461	251
HP-30B	7983	236	MU435004	16254	99	N802737-S	13469	443	N807706-S	19326	436
HP-30C	7984	236	MU480034	19322	536	N802775-S36	16883	64	N807721-S	17612	366
HP-30D	7985	236	MU481027	19325	538	N802781-S	14020	444	N807875-S	19524	380
HP-30N	7981	236	MU481187	19323	537	N802900-S	12565	374	N807943-S	19810	374
H001-50-609	14719	523	MU840004	15931	175	N802900-S	13470	375	N807951-S	18820	363
H001-50-841	14695	507	MU840015	15926	175	N803043-S	13750	242	N807994-S	18816	438
H001-68-719B	17451	525	MU840016	15927	175	N803170-S	14021	362	N808048-S	16726	444
H115-67-099	15926	175	MU840021	15931	175	N803183-S32	14814	103	N808147-S	14991	411
H116-67-099	15927	175	NA01-50-101A	19228	522	N803387-S	15668	371	N808182-S309	19436	449
H117-67-099	15931	175	NA01-56-145	16858	547	N803387-S300	15668	371	N808331-S	18895	442
H260-50-6K8	19833	524	NA01-56145	16858	547	N803421-S	14019	445	N808332-S	18894	442
H3	20600	205	N-014-389-3	13173	573	N803494-S	14953	441	N808342-S307	20546	448
H3-12V55W	20600	205	N-015-422-2	13217	574	N803613-S	16863	371	N808370-S	19127	367
H4	18661	205	N10320101	16897	204	N803638-S36B	14895	449	N808426-S100	19396	256
H4-12V60W55W	18661	205	N14-4003	11404	575	N803678-S	20332	363	N808594-S100	18396	249
H4-12V60W55W	20601	205	N14-443-4	11403	575	N803685-S11	14820	423	N808689-S417	19458	250
JB66PB7	18089	372	N15-422-2	13217	574	N803709-S	17103	414	N808791	20273	443
JB66PD5	18087	372	N15-457-1	13222	498	N803716-S	14018	444	N808842-S	19338	370
J0Y1-50-619C	19452	523	N185101	11101	575	N803734-S	15480	367	N808847-S	19244	444
J3081054	18035	461	N185112	11099	575	N803763-S100	20415	423	N808908-S	19337	445
J4003084	185	229	N185151	11097	575	N803768-S	18155	435	N811006-S	18936	380
J4004175	9298	82	N185161	11098	575	N803857-S	20311	362	N811090-S100	20413	258
J4004354	9297	82	N185301	11100	575	N803862-S	13751	242	N811169-S	19783	559
J4004354	10087	82	N304-13-356-A	14697	513	N803933-S101	17408	250	N811257-S100	20421	449
J4005293	10087	82	N605771-S100	12341	51	N803946-S	14992	442	N811257-S309	20421	449
J4006956	18163	85	N605771-S2	12341	51	N803968-S100	14819	448	N811259-S	18812	234
J4007456	20419	462	N605774-S2	12338	51	N804189-S	13747	242	N811353-S100	20171	437
KA01-50-H15A	17554	525	N605800-S2	12329	54	N804193-S100	18167	249	N811460-S100	19419	251
KA01-50-H16	17553	525	N605920-S2	12327	54	N804343-S	13748	242	N811534-S61	19653	58
KA78-50-AF4	19748	524	N606676-S100	12160	51	N804349-S	15479	369	N811772-S	19472	419
KA80-51PR6	18882	522	N606676-S2	12160	51	N804379-S	15478	368	N811849-S300	19517	438
KA80-51-RF5A	18822	522	N606676-S36	15778	51	N804448	14757	364	N-900-845-01	17006	252
LA01-56-135	14750	572	N606677-S36	12335	52	N804472S	15495	242	N90100001	12595	575
LA01-50-6A8A	19831	523	N606677-S43B	15779	52	N804523-S	17431	254	N8100001	16268	64
LB82-50-669A	19755	523	N606677-S53B	15779	52	N804570-S	14753	411	N905150-S	17466	255
LB84-68-AD5	19832	524	N606690-S2	15780	54	N804583-S	15187	252	N90561601	18661	205
LR69PB7	18089	372	N606692-S2	16931	54	N804674-S	15701	444	N90561601	20601	205
LR69PD5	18087	372	N610959-S2	13019	59	N804675S	17101	242	N90561601	18661	205
LS101	9883	177	N620391-S36	17495	65	N804741-S2	19677	448	N90561601	20601	205
L0009006XS	16898	204	N620480	15316	64	N804741-S32B	19677	448	N-906-349-01	17006	252
L01255H3	20600	205	N620480-S2A	15316	64	N804759S	15491	242	N989022	11351	368
L562	20402	249	N620482	15318	64	N804765-S	19277	436	N98905101	11678	379
L891	20598	205	N621900	15325	64	N804837-S	14994	443	OA-13713	13435	209
MB020923	19385	537	N621903	15326	64	N804851-S100	19516	257	OH452KD5	17080	459
MB023930	14366	542	N621905	15328	64	N804992-S58	10654	4	PR2	16927	202
MB029111	14277	560	N621906-S36	16774	64	N805017SW	18860	444	PT181	12564	153
MB098145	14275	560	N621907	15332	6						

# O.E.M. INTERCHANGE BY NUMERICAL ORDER

O.E.M. No.	Auveco No.	Page No.	O.E.M. No.	Auveco No.	Page No.	O.E.M. No.	Auveco No.	Page No.	O.E.M. No.	Auveco No.	Page No.
PT549.....	11440.....	185	YL3Z-1521971-AA.....	20195.....	529	01553-S3500A.....	13945.....	545	10229345.....	18831.....	407
PT663.....	12751.....	199	YS4Z-13N021-AA.....	18661.....	205	01651-00481.....	14695.....	507	10229437.....	18680.....	369
P21/5W.....	20593.....	203	YS4Z-13N021-AA.....	20601.....	205	02809-19300.....	19327.....	545	10237960.....	19220.....	423
P21W.....	20592.....	203	YS4Z-16K262-AA.....	20191.....	442	03-446-243.....	12642.....	550	10241518.....	18688.....	369
QL77SC1.....	19382.....	370	YS4Z-6730-AA.....	20347.....	219	043-101-457S.....	19217.....	63	10242285.....	20521.....	405
QL77SJ.....	19384.....	370	000-987-10-15.....	13148.....	532	0483-66-061-A.....	14358.....	524	10242316.....	18680.....	369
QL77SK4.....	19383.....	370	000-987-10-81.....	13157.....	531	07-11-9-901-294.....	13215.....	534	10242602.....	20617.....	406
R5W.....	20590.....	203	000-988-15-81.....	13141.....	531	07-11-9-916-945.....	13215.....	534	10246149.....	19788.....	411
SD42BS.....	5748.....	234	000-988-16-25.....	20647.....	531	07-12-9-925-708.....	13223.....	533	10249241.....	19501.....	369
SK42BS.....	5750.....	234	000-988-23-78.....	13145.....	532	07-12-9-925-720.....	13162.....	498	10257286.....	19525.....	376
SSC42.....	5750.....	234	000-988-55-81.....	13144.....	531	07-12-9-925-730.....	13222.....	498	10261327.....	19410.....	398
SSP42.....	5748.....	234	000-988-56-71.....	13153.....	530	07-12-9-925-737.....	13218.....	534	10262036.....	18684.....	362
S084-58-S02.....	20463.....	525	000-988-86-25.....	20404.....	531	07-12-9-929-706.....	13221.....	498	10262143.....	19247.....	395
TY98TL2-AA.....	20541.....	370	000-990-03-92.....	13230.....	532	08-54-699-800.....	13207.....	550	10270517.....	20464.....	408
T001-50-M48B.....	19450.....	522	000-990-21-92.....	13142.....	530	09409-07313.....	17383.....	412	10270672.....	19390.....	405
T4W.....	20589.....	203	000-990-22-92.....	13230.....	532	09409-07325.....	19243.....	410	10271562.....	19523.....	396
UB39-45-919.....	20465.....	527	000-990-25-92.....	19434.....	532	10003294.....	12919.....	134	10274528.....	19438.....	422
UB39-50-795.....	19747.....	527	000-990-34-92.....	20187.....	532	10003617.....	12927.....	135	10274778.....	19819.....	341
UB42-67-013.....	19754.....	529	000-990-37-92.....	20314.....	532	10004121.....	12943.....	135	10277480.....	19676.....	395
W-158.....	15003.....	86	000-990-40-92.....	20640.....	532	10004329.....	13929.....	393	10278936.....	17654.....	243
W-159.....	15004.....	86	000-990-44-92.....	20639.....	532	10005510.....	14968.....	421	10280777.....	19543.....	381
W-246.....	15018.....	87	000-990-46-92.....	20641.....	532	10008002.....	8814.....	108	10281487.....	20395.....	423
W-486.....	15009.....	86	000-990-57-92.....	20642.....	532	10008002.....	10052.....	108	10281610.....	19530.....	418
W-487.....	15010.....	86	000-994-04-45.....	13224.....	534	10009690.....	13929.....	393	10283414.....	19368.....	372
W-5.....	15016.....	87	000-994-06-45.....	13218.....	534	10009923.....	12259.....	66	10285935.....	19270.....	378
W5W.....	20591.....	203	000-994-09-45.....	13220.....	534	10013153.....	13924.....	398	10287379.....	20261.....	52
W520802-S426.....	12669.....	109	000-994-13-45.....	13152.....	533	10013764.....	11352.....	421	10287547.....	20408.....	406
W520815-S436.....	19901.....	111	000-994-14-45.....	13215.....	534	10014363.....	12997.....	97	10287926.....	20232.....	401
W525170-S.....	19462.....	248	000-994-14-45.....	13216.....	498	10017487.....	12931.....	133	10287971.....	19275.....	378
W525170-S417.....	19414.....	248	000-994-25-45.....	13223.....	533	10017615.....	14677.....	219	10291232.....	19392.....	405
W525172-S.....	19110.....	248	000-994-50-45.....	13222.....	498	10018202.....	12695.....	85	10293836.....	19438.....	422
W525172-S417.....	19461.....	248	000-997-91-86.....	20643.....	532	10027015.....	17230.....	395	10297368.....	19381.....	406
W525174-S.....	19420.....	249	001-988-12-25.....	20646.....	531	10027915.....	16827.....	394	10297369.....	20521.....	405
W525174-S300.....	19420.....	249	001-988-20-81.....	16124.....	531	1003.....	13918.....	202	10297371.....	19379.....	406
W525175-S.....	19456.....	249	001-988-20-81.....	20205.....	531	10031004.....	18014.....	202	10298115.....	19486.....	392
W-6.....	15017.....	87	001-988-29-81.....	20204.....	531	10032838.....	12713.....	551	10301966.....	20365.....	415
W-7.....	15014.....	86	001-988-31-81.....	20239.....	530	10036503.....	14023.....	242	10308019.....	20521.....	405
W700501-S303.....	19181.....	58	001-988-49-81.....	20238.....	530	1004.....	16920.....	202	10308063.....	20520.....	407
W700548-S300.....	18382.....	50	001-988-51-81.....	20198.....	530	10040001.....	9282.....	227	10323057.....	20607.....	407
W700566-S300.....	18383.....	435	001-988-76-81.....	20205.....	531	10041588.....	14527.....	105	1034.....	16925.....	202
W700614-S300.....	18498.....	440	001-988-77-81.....	20200.....	531	10051034.....	15467.....	341	10341794.....	20464.....	408
W700636-S303.....	20398.....	252	001-990-00-91.....	20651.....	534	10053182.....	14997.....	411	10363811.....	20634.....	374
W700671-S300.....	20319.....	367	00234-00192.....	20286.....	203	10053388.....	15045.....	417	10403591.....	19449.....	373
W700770-S300.....	19471.....	364	00234-00194.....	16902.....	202	10056725.....	19502.....	423	10405030.....	19368.....	372
W700800-S300.....	18384.....	435	00234-01156.....	16904.....	202	10062.....	12253.....	66	10408480.....	19527.....	378
W701054-S300.....	18503.....	445	00234-01156.....	19608.....	207	10062366.....	18117.....	421	10413086.....	19438.....	422
W701133-S300.....	18386.....	446	002-994-65-45.....	20235.....	530	10063599.....	18683.....	362	10421018.....	20338.....	378
W701223-S300.....	20194.....	441	003-988-19-78.....	20644.....	532	10069112.....	15488.....	242	10423553.....	20481.....	405
W701374-S.....	20399.....	363	003-988-41-78.....	20188.....	532	10073833.....	12992.....	380	10425306.....	20365.....	415
W701380-SSW.....	18379.....	364	003-994-30-45.....	13218.....	534	10077283.....	15042.....	417	10431524.....	19757.....	406
W701430-S300.....	18377.....	439	004-988-76-78.....	20657.....	530	10078274.....	18897.....	364	10431761.....	19821.....	408
W701566-S417.....	18331.....	257	004-988-77-78.....	20657.....	530	10082288.....	18390.....	406	10437565.....	19800.....	407
W701649-S.....	19237.....	437	006-988-30-78.....	20201.....	530	10084751.....	19644.....	110	10442914.....	20353.....	405
W701855-S300.....	20366.....	365	006-988-35-78.....	20199.....	530	10089262.....	14987.....	411	10443956.....	20328.....	407
W701971.....	20169.....	445	006-988-72-78.....	20236.....	530	10098645.....	18682.....	363	10443956.....	20377.....	407
W701993-S.....	17604.....	321	01241-00551.....	17193.....	549	10102434.....	17436.....	428	10476561.....	9282.....	227
W702010-S300.....	19532.....	372	01281-00022.....	14331.....	541	10108746.....	16625.....	416	106212.....	14335.....	542
W702380S300.....	18504.....	447	01281-00023.....	14275.....	560	10109689.....	15490.....	242	106653.....	12543.....	174
W702412-S300.....	19345.....	440	01281-00151.....	14335.....	542	10119816.....	18859.....	364	10708.....	12522.....	85
W703505-S301.....	20306.....	441	01281-00231.....	14275.....	560	10119853.....	17128.....	397	10709.....	12520.....	85
W703507-S300.....	19805.....	440	01281-00231.....	14695.....	507	10120608.....	18929.....	257	1073.....	18004.....	202
W703842-S300.....	20193.....	441	01281-00441.....	17342.....	541	10121502.....	17664.....	366	1076.....	18469.....	202
W703919-S300.....	20193.....	441	01281-00481.....	19146.....	543	10125439.....	16864.....	253	10998-30880.....	14696.....	513
W704881-S300.....	19237.....	437	01281-00501.....	19292.....	543	10126901.....	15669.....	379	11005.....	20299.....	203
W704958-S300.....	19511.....	445	01281-00601.....	19293.....	542	10129981.....	15811.....	65	11006.....	20300.....	203
W705532-S300.....	16726.....	444	01281-00711.....	20604.....	542	10131511.....	18461.....	251	11054611.....	11711.....	65
W705550-S300.....	19783.....	559	01281-00741.....	20258.....	542	10134407.....	18030.....	415	111-26-AA000.....	19139.....	217
W705589-S300.....	11146.....	366	01553-00051.....	14356.....	544	10135796.....	18118.....	400	111-837-5815.....	13031.....	576
W705590-S300.....	20466.....	396	01553-00172.....	14737.....	563	10139822.....	14991.....	411	111-837-581J.....	13031.....	576
W705849-S300.....	20355.....	440	01553-00202.....	14347.....	544	10140480.....	16835.....	412	113-853-585B.....	13176.....	573
W705955-S300.....	20177.....	364	01553-00291.....	14349.....	543	10143422.....	17102.....	375	113-853-585C.....	10322.....	573
W705956-S300.....	20233.....	443	01553-00291.....	14355.....	543	0153057.....	16695.....	378	113-853-585C.....	13229.....	573
W705957-S300.....	20518.....	445	01553-00401.....	14355.....	543	10154466.....	18158.....	362	113-853-615A.....	13227.....	574
W706172-S309.....	20401.....	449	01553-0052U.....	20671.....	544	10157547.....	16939.....	256	113-857-219A.....	13206.....	574
W706182-S300.....	20516.....	443	01553-00545.....	17452.....	543	10157900.....	16622.....	415	1141.....	16923.....	202
W706494-S300.....	19849.....	442	01553-01121.....	17452.....	543	10158124.....	18175.....	375	1142.....	20681.....	203
W706519-S300.....	20518.....	445	01553-01182.....	20256.....	544	10159259.....	20379.....	416	11500081.....	12347.....	60
W706575-S300.....	20393.....	436	01553-01393.....	16843.....	548	10160960.....	18935.....	255	11500086.....	12350.....	60
W706713-S300.....	20367.....	442	01553-01781.....	17634.....	543	10167445.....	19357.....	404	11500421.....	2775.....	4
W707606-S300.....	20517.....	437	01553-02041.....	20167.....	544	10167448.....	18428.....	403	11500434.....	15373.....	58
W708035-S300.....	20531.....	364	01553-02741.....	17378.....	548	10167456.....	18425.....	403	11500654.....	18337.....	108
W708045-S300.....	20532.....	436	01553-02821.....	20670.....	545	1016937.....	12669.....	109	11500655.....	11625.....	108
W708088-S300.....	18770.....	362	01553-03101.....	17378.....	548	10169777.....	20344.....	362	11500656.....	18338.....	109
W708384-S309.....	20401.....	449	01553-06161.....	19367.....	546	10182300.....	20332.....	363	11500657.....	11626.....	109
W708530-S300.....	20632.....	416	01553-06721.....	17347.....	548	10184895.....	13751.....	242	11500658.....	11628.....	110
W708621-S300.....	20190.....	376	01553-07111.....	20669.....	545	10185866.....	2				

# O.E.M. INTERCHANGE BY NUMERICAL ORDER

O.E.M. No.	Auveco No.	Page No.	O.E.M. No.	Auveco No.	Page No.	O.E.M. No.	Auveco No.	Page No.	O.E.M. No.	Auveco No.	Page No.
11500997	12354	60	11504522	11939	55	11518201	20281	368	12040983	19851	419
11501105	11633	53	11504531	9879	105	11518357	20377	407	12040984	19440	419
11501106	11642	64	11504536	13002	99	11509030	20664	377	12043215	16694	181
11501188	13614	54	11504551	14569	55	11519031	20616	377	12045234	15927	175
11501193	11641	54	11504565	13619	54	11519444	20359	416	12045236	15926	175
11501194	13620	54	11504567	13614	54	11519952	20422	424	12045773	18653	155
11501794	12739	56	11504570	12067	51	11519960	20423	424	12046624	16693	181
11501800	15334	64	11504614	15327	64	1155	18470	202	12047581	15498	155
11501814	12254	66	11504646	14572	55	1156	16904	202	12047680	15497	155
11501835	12253	66	11504647	11943	55	1156	19608	207	12047767	15499	155
11501836	12255	66	11504654	11941	55	1156NA	17597	202	12048074	18654	155
11501849	12260	66	11504655	11944	55	1157	16899	202	12048247	18655	157
11501850	11645	65	11504656	11940	55	1157	19609	207	12048369	14918	180
11501851	12256	66	11504659	11938	55	1157NA	16901	202	12048451	18660	156
11501854	15714	66	11504661	14049	55	1157NA	19610	207	12052466	15500	155
11501883	12059	56	11504662	14046	5	11588988	20631	416	12052922	16806	155
11501884	12060	30	11504663	11945	55	1165051	19626	578	12065158	18150	154
11501889	11644	65	11504693	11626	109	1165051	19627	578	12066214	14881	156
11501896	12061	56	11504785	14047	55	1176	20585	203	12066272	20208	155
11501899	12257	66	11504978	12666	109	1178	20586	203	12066614	20231	157
11501903	12062	56	11504981	12068	60	117971	4417	322	12076946	17175	179
11502453	12318	59	11504982	12343	54	119005	16897	204	12077140	18193	164
11502479	12659	24	11505005	12596	64	1195	18471	202	12077411	18657	156
11502480	12659	24	11505022	12351	59	1196781	3682	38	12083005	16585	179
11502480	12660	24	11505023	12339	60	12001470	13549	177	12083006	16586	179
11502483	12097	57	11505044	18416	52	12003757	13546	179	12083007	17108	177
11502507	15711	66	11505048	19144	109	12003758	13545	179	12083460	18924	177
11502556	12251	66	11505104	13712	56	12003759	12600	179	12083680	17172	180
11502605	11639	53	11505182	14053	55	12003878	13544	178	12083689	17173	180
11502609	11644	65	11505209	13618	52	12004005	12550	174	12084595	15948	153
11502617	11629	110	11505326	15790	53	12004007	12552	174	12084912	20209	157
11502624	11639	53	11505329	12595	575	12004009	12554	174	12084913	20210	157
11502693	12692	53	11505329	16268	64	12004010	12555	174	12085330	17174	180
11502722	19309	65	11505475	15323	64	12004035	15368	184	12085480	15368	184
11502737	12127	66	11505596	18338	109	12004188	19199	167	12085483	18916	180
11502759	12126	66	11505835	14050	55	12004201	8775	153	12085485	19882	183
11502770	10171	1	11505865	12108	66	12004311	12237	177	12085487	18872	184
11502785	11627	110	11506101	11645	65	12004475	18450	159	12085489	18315	184
11502790	11935	53	11506117	15335	64	12004610	14882	155	12085491	16968	183
11502811	11709	64	11506174	12693	51	12004996	15958	155	12085495	18868	181
11502812	11708	64	11507036	11644	65	12010031	15369	184	12085496	17114	180
11502843	12743	57	11507036	16269	65	12010085	15948	153	12085497	18524	181
11502873	12319	59	11508023	12322	51	12010182	15937	153	12085498	16694	181
11502941	12693	51	11508241	12575	109	12010293	18326	153	12085499	17197	182
11503284	17083	29	11508269	13614	54	12010300	15955	153	12085500	18529	182
11503289	17083	29	11508275	15330	64	12010717	15953	154	12085502	16964	183
11503317	11630	110	11508561	14051	55	12010973	15951	154	12085503	16514	182
11503394	12740	57	11508654	15713	66	12010974	18146	154	12085506	18918	183
11503395	12741	57	11508797	12318	59	12010975	18152	154	12085507	16965	183
11503396	12742	58	11508879	14052	5	12010996	15949	154	12085521	16513	182
11503421	12213	4	11508900	12253	66	12012000	14884	160	12085525	17109	181
11503432	12117	66	11508905	12347	60	12013813	13543	179	12085527	17109	181
11503455	12667	110	11508927	13002	99	12014012	14462	154	12085528	17109	181
11503483	12742	58	11508930	15791	51	12014836	14153	153	12085533	17199	183
11503503	12097	57	11508987	14185	65	12014837	14154	153	12085538	18917	181
11503578	18261	57	11509189	12350	60	12015024	18148	154	12089040	14150	153
11503619	13613	53	11509371	12057	59	120151	12546	174	12089188	14151	153
11503632	12336	53	11509374	12741	57	12015193	20618	153	12089189	13659	148
11503636	12213	4	11509511	11639	53	12015323	14152	153	12089189	19258	148
11503668	13705	54	11509535	15711	66	12015387	15923	154	12089190	13669	148
11503687	15310	61	11509589	11638	53	12015631	19795	419	12089190	19259	148
11503695	15335	64	11509816	12067	51	12015791	15950	154	12089191	13678	148
11503714	11864	109	11510062	12253	66	12015792	15952	154	12089191	19262	148
11503715	12575	109	11513798	20600	205	12015793	15954	154	12089305	15948	153
11503716	11864	109	11513801	12738	57	12015797	18145	154	12089306	18325	153
11503722	12108	66	11513864	12064	51	12015798	18147	154	12089340	16806	155
11503736	14980	66	11514282	15711	66	12015799	18151	154	12089507	14882	155
11503745	19205	65	11514290	16840	105	12015857	14881	156	12089649	14883	155
11503752	12595	575	11514343	11639	53	12015858	20216	156	12092344	20226	156
11503754	12596	64	11514518	11644	65	12015861	15938	156	12092345	20227	156
11503756	12596	64	11514596	11644	65	12015862	15948	153	12094429	20583	160
11503785	18261	57	11514623	12067	51	12015870	15945	157	12100	17995	202
11503791	13715	51	11515478	12575	109	12015878	17002	153	12101855	18870	180
11503792	12345	52	11515566	18781	57	12015917	18324	153	12101856	18320	181
11503800	12324	51	11515614	19901	111	12015972	15952	154	12101857	18318	181
11503812	12064	51	11515757	13614	54	12015983	16941	419	12101859	18318	181
11503815	12322	51	11515893	12213	4	1201930	13195	576	12101869	18151	154
11503825	13618	52	11516148	18477	202	12020116	14880	156	12101880	18867	180
11503833	15788	52	11516150	11630	110	12020120	15939	156	12101885	19553	187
11503834	12065	52	11516150	12667	110	12020126	15944	157	12101895	17109	181
11503892	15373	58	11516372	20416	109	12020320	11948	155	12101897	16174	180
11503941	13617	51	11516397	20339	108	12020321	18650	155	12101898	16175	180
11503957	11864	109	11516596	13705	54	12020346	11947	155	12101903	17690	184
11503957	12669	109	11516780	15335	64	12020347	15935	155	12101906	16967	180
11503958	13715	51	11516942	13619	54	12020757	14883	155	12101909	17691	186
11503982	12066	52	11517293	12596	64	12020758	15925	155	12101914	18319	184
11504010	15721	57	11517343	12065	52	12027133	18923	179	12101917	13686	171
11504035	11627	110	11517517	12324	51	12033674	14150	153	12101927	19554	185
11504047	16842	109	11517706	13619	54	12033816	18649	155	12101933	18316	184
11504056	12738	57	11517769	20368	423	12033817	15960	155	12101937	17113	182
11504069	11937	55	11517803	16622	415	12034046	15947	156	12101939	18871	187
11504230	1943	3	11517873	20452	395	12034047	15946	156	12102568	17463	183
11504288	12667	110	11517992	20615	370	12034051	14151	153	12102620	16693	181
11504477	14950	55	11518017	20632	416	12034053	14882	155	12102621	14580	182
11504493	12323	52	11518091	20170	257	12034342	18149	154	12102747	17110	181
11504515	12352	60	11518121	12669	109	12040902	15924	155	12102748	18527	182

# O.E.M. INTERCHANGE BY NUMERICAL ORDER

O.E.M. No.	Auveco No.	Page No.	O.E.M. No.	Auveco No.	Page No.	O.E.M. No.	Auveco No.	Page No.	O.E.M. No.	Auveco No.	Page No.
12102757	19555	186	124-990-07-92-9C75	20203	533	14072598	15680	334	15613177	19375	66
12103360	20230	156	12506127	18511	403	14074081	14036	365	15614774	18244	254
12103881	15497	155	12519972	18429	402	14078435	11852	248	15622475	18507	393
12110649	20229	156	12519975	18417	402	14082956	18817	57	15622490	17615	251
12110652	20228	156	12530252	17654	243	14083173	14820	423	15632790	17508	423
12110842	20217	156	12533567	17103	414	14083901	14952	55	15638097	19222	421
12110843	20219	156	12535713	19398	380	14090382	19278	58	15638098	19221	421
12110844	20218	156	12540326	19725	426	14090908	16026	217	15638413	16938	378
12110845	20222	156	1254815	11838	393	14093088	14020	444	15641800	11110	27
12110846	20225	156	1255	20600	205	14093869	14980	66	15646148	17343	427
12110847	20224	156	1-255-551	14211	576	14097279	16739	27	15648833	14988	441
12116958	17111	181	1-255-553	14210	576	14100784	17382	423	15650655	9880	105
12117353	18526	184	1255823	11865	395	14101262	15702	417	15653790	19781	426
12117354	19556	184	1257702	14217	420	14103026	12084	246	15659161	17072	372
12117361	17109	181	1260888	19166	106	14103026	17424	247	15660361	17345	428
12117375	18526	184	1260/H4	18661	205	14103435	16953	419	15672149	19242	411
12117384	13547	186	1260/H4	20601	205	14103438	15042	417	15672183	19782	426
12117385	17107	182	1261968	19664	54	14103461	15043	416	15672328	17599	381
12117387	18145	154	1264963	12713	551	14-20-23-83	13197	498	15672330	14998	412
12124075	20214	155	1268176-3	19248	577	142451	20292	203	15672713	18167	249
12124076	20215	155	127934	16910	202	142452	16911	202	15676045	18933	412
12124304	15938	156	1295NA	19208	202	142453	18015	202	15678493	17215	371
12124515	8774	153	1304225	4249	328	142454	16926	202	15681408	17103	414
12124580	15937	153	13050	17994	202	142456	16923	202	15682898	18262	422
12124581	18324	153	131282	16914	202	14250053	18001	202	15685040	19424	427
12124582	15948	153	131-853-585C	10322	573	1445	18472	202	15685099	20415	423
12124587	18325	153	13235-A	8763	199	1449	18473	202	15686047	15792	26
12125637	11440	185	13-3008-L	15004	86	145525	14388	212	15686142	18153	422
12126032	12751	199	13-3008-R	15003	86	1476344	16131	577	15690531	18744	241
12126451	18674	182	13-3026-L	15010	86	1480627	8359	107	15690729	18977	397
12126452	15952	154	13-3026-R	15009	86	1480909	8377	107	15691493	16936	429
12126460	19553	187	1342-004	17314	576	1494015	10072	101	15691595	19424	427
12129373	20213	155	1351769	9112	127	1494252	8359	107	15694099	18391	375
12129409	20223	156	1355003	9069	394	1494253	10830	108	15704030	19515	253
12129484	20212	155	13-6002	15016	87	1494254	10054	108	15705372	11246	389
12129493	18658	156	13-6003	15017	87	1494257	10051	107	15707256	19317	423
12129497	18659	156	13-6005	15018	87	1494258	8814	108	15709521	18262	422
12160374	20665	419	1366042	16739	27	1494258	10052	108	15715058	17654	243
12160551	20211	157	1370853	12735	574	15002519	19617	66	15731424	20414	53
12160857	20514	420	1372920-7	20406	576	15002520	18262	422	15732202	18028	242
12160858	20397	419	1373789	10369	396	15006827	20345	369	15733970	19614	397
12167116	18916	180	1377030	10365	396	15015804	18889	256	15733971	19613	397
12176844	19853	420	13-8003	15014	86	15021761	20312	518	15737532	12520	85
12186456	20220	156	13-8004	15015	86	15022087	19395	257	15737533	12522	85
12186457	20221	156	1395-68-676	14369	528	15025531	19616	422	15745990	20527	397
1231490	10369	396	14001841	16742	55	15026222	20158	475	15745991	20529	397
12337852	14031	394	14001842	16741	55	15026223	20157	475	15748479	20268	422
12337868	15518	425	14002811	13002	99	15028528	20159	475	15764320	19616	422
12337873	10054	108	14003784	16986	24	15029527	20161	478	158	18014	202
12337898	17341	341	14004876	12931	133	15029828	4369	328	15953247	15970	380
12337900	16953	419	14005089	11854	412	15031239	17654	243	15953247	17649	380
12337915	15490	242	14005097	16248	99	15046306	20619	422	15954398	19429	395
12337916	15783	26	14007510	13231	98	15056810	20362	368	15955172	13752	242
12337917	12669	109	14007510	13232	98	15076791	20444	377	15955523	17654	243
12337918	18928	392	14007511	14976	98	15149708	19639	415	15956062	18169	252
12337920	12737	379	14007940	12999	97	15153415	19615	416	15956470	14998	412
12337920	14524	379	14008227	12210	133	152266	8375	107	15958694	11146	366
12337963	15455	330	14011722	11109	27	152267	8372	108	15959832	18268	417
12337966	11630	110	14013246	13960	394	152273	15677	107	15959833	18334	418
12338011	15467	341	14017701	12930	133	152863	16581	453	15960325	18353	418
12338015	17437	428	14017705	12923	134	152867	11832	453	15960621	19355	414
12338025	13009	99	14017779	12947	135	15300530	19882	183	15963179	16938	378
12338034	15453	329	14017780	12924	134	15305932	18524	181	15964971	16936	429
12338035	11417	353	14019205	12567	413	153297	16478	29	15964972	16937	429
12338074	16936	429	14019205	13996	415	154508	16531	30	15967691	19424	427
12338088	11943	55	14019205	14753	411	154534	16534	30	15969147	17216	416
12338089	12594	400	14019206	14007	413	15502538	8931	235	15975244	19834	366
12338094	17125	53	14019226	14011	413	15505451	16251	99	15986343	18371	365
12338096	12824	401	14021204	16208	388	15506827	14012	242	15986673	19356	378
12338114	9112	127	14022878	12621	400	1550971	18474	202	15989484	19388	418
12338123	2775	4	14023108	12925	134	15530810	16943	327	15989487	19387	418
12338141	12659	24	14025274	12916	134	15537954	17345	428	15990498	20451	424
12338146	10052	108	14027125	16944	327	15545178	18926	425	15993201	16622	415
12338150	16719	409	14027471	12759	369	15545202	15670	380	15994165	20542	415
12338153	12658	249	14029095	12940	135	15545202	15970	380	1600375	10759	390
123-401-01-28	13149	534	14031114	12926	134	15562609	16937	429	1605396	11146	366
12353912	15463	340	14031144	12916	134	15562610	17976	428	1605396	15414	366
12354969	15948	153	14031145	12932	135	15567924	15459	424	1606642	11657	390
12354970	15937	153	14031149	12941	134	155-809-966	12735	574	1606642	11659	391
12355104	9481	152	14031900	16880	65	15588024	13946	380	161	20285	203
12355107	14150	153	14032200	14008	409	15588078	14032	365	1610403	12917	134
123551107	14153	153	14032291	14009	396	15591860	19424	427	1614858	12931	133
123-990-00-92	20636	533	14037239	18926	425	15594416	14028	364	1617333	12919	134
123-990-01-92	17668	530	14039420	14001	410	15596279	14031	394	161-867-299-01C	19195	574
123-990-02-92	20637	533	14040999	16322	110	15596280	14037	396	1618890	11470	390
123-994-01-45	20648	533	14045480	14010	413	15596301	13946	380	1618890	11657	390
123-994-03-45	20652	533	14046480	12728	420	15597271	14215	399	1618890	11659	391
123-994-08-45	20650	534	14046514	12928	135	15598757	15792	26	1619321	12137	368
1243-50-609	12591	523	14047034	12929	133	15598845	17344	428	1619321	16263	368
1244839	9965	578	14048060	13005	99	15600382	10621	379	1621253	12935	133
12450143	20594	205	14060613	12692	53	15600382	12992	380	1622920	16247	99
12450176	20595	204	14063981	13750	242	1560058	19626	578	1623436	12998	97
1-246-926	14212	576	14066728	17437	428	1560058	19627	578	1624705	2744	578
1-246-993	14209	576	140-698-00-82	20656	531	15607139	18105	422	1624705	12959	578
1247872	15459	424	14070914	13749	242	15607165	15970	380	1631564	15478	368
124-990-05-92-905											

# O.E.M. INTERCHANGE BY NUMERICAL ORDER

O.E.M. No.	Auveco No.	Page No.	O.E.M. No.	Auveco No.	Page No.	O.E.M. No.	Auveco No.	Page No.	O.E.M. No.	Auveco No.	Page No.
1636632	16624	415	194	19611	207	20452072	14007	413	21077405	17227	412
1638	20295	203	194NA	18012	202	20453400	12064	51	21093072	17637	256
1638575	19162	106	194NA	19612	207	20455900	14006	362	21093588	17219	401
1640810	15373	58	19630330	19389	403	20461373	13856	419	21094146	16818	364
1641-B	9257	222	198	16924	202	20462090	16865	408	21094240	18515	51
1644290	18948	362	199	18466	202	20465395	14005	242	21094747	17220	242
16500308	14016	414	1H0-853-733B	19136	573	20467623	14222	399	21095560	18881	109
16502342	20301	36	1J0-853-120	20260	573	20475949	14013	575	21095741	18880	109
16503329	14002	393	1L5Z-17K826-AA	19638	461	20475950	14014	573	21095797	18896	416
16503548	14145	394	1U5Z-13466-BB	16901	202	20477732	16687	252	21097229	19854	414
16506582	17000	389	1U5Z-13466-BB	19610	207	20477850	15464	341	21097292	19902	421
16506617	19549	391	20007308	17074	408	20478294	13860	418	21098967	19397	340
16510893	15676	393	20030401	15457	370	20478295	13456	419	211-2	16913	202
16514113	14007	413	20032850	11679	363	20478733	15462	340	21110145	16816	414
16524431	18662	204	20037597	12314	430	20480475	13453	379	21170211	19909	420
1654047	11345	338	20043351	19183	427	2048248	11673	368	212-2	18011	202
1654048	11427	338	20043361	19183	427	20487630	15463	340	21513-21000	19007	217
1660123	11717	400	20046147	14559	427	20491451	13826	420	217-770	15932	175
16606936	17069	424	20046150	11816	399	20493450	17455	341	217-771	15933	175
16607593	14967	425	20057138	13437	209	20510029	13993	415	217-772	15934	175
16609280	19399	425	20058837	18398	408	20511451	13454	363	2201406	12522	85
16611887	18419	406	20059774	12333	53	20514862	15367	363	2201407	12520	85
16611888	18420	406	20064875	15456	370	20538173	18302	362	22049766	19068	344
16611889	18418	402	20067021	11802	399	20547865	14147	417	2207713	16132	577
16614134	18274	406	20085729	17073	343	20556873	13857	420	22093245	17177	252
16615006	19370	404	20095324	18399	358	20558726	17435	428	22098790	19085	347
16616138	19008	407	20097200	12569	436	20561698	15155	65	22098842	19079	346
16629990	19658	425	2011554	12084	246	20565924	18678	418	22189414	20360	367
16632192	16937	429	2011554	17427	247	2057	16907	202	222	20287	203
16632193	16936	429	20123070	15467	341	2057NA	16908	202	22-44567-000	19844	477
16633853	17069	424	20130258	13002	99	20570245	13994	417	22505958	12934	134
16659131	20369	380	20130258	13001	99	20582532	18392	425	22508049	12932	135
16662182	19519	422	20130258	13003	99	20582533	18393	425	22508050	12918	134
16674629	20189	367	20138524	12733	418	20589218	13437	209	22508051	12937	133
16675980	19658	425	20160591	15466	341	20590899	13996	415	22508052	12927	135
16715497	17468	252	20162174	17176	341	20590899	14753	411	22508803	11419	135
16723225	12084	246	20169887	12135	338	20603072	11152	337	22511449	12945	135
16723225	17427	247	20171942	12594	400	20606416	14945	399	22512114	12828	401
16-7552	9481	152	20175051	12563	400	20606417	14946	399	22512276	12766	368
16758	4248	328	20184399	12658	249	20612732	13746	242	22512276	16262	368
16758A	4155	328	201-988-03-78	16123	530	20624923	14014	573	22512857	12605	391
168	16921	202	201-988-04-78	20202	530	20626174	19394	342	22513813	12605	391
1688094	11425	400	201-988-06-78	20658	530	20632190	17666	408	22514578	14003	394
1689827	12095	29	201-988-07-78	20197	530	20635065	13994	417	22514924	14821	392
1698296	11469	336	201-988-25-78	20644	532	2064891	10621	379	22516030	20450	65
1703469	11417	353	201-990-00-50	20645	533	2064891	16260	379	22517337	11941	55
1706200	13828	401	201-990-02-92	20638	533	20652520	18679	368	22520368	16239	99
17131	20589	203	20199675	14642	400	20664092	14753	411	22524005	14004	242
17171	20590	203	201-997-22-81	20659	531	20664092	14993	411	22527147	18748	422
17177	20591	203	20200750	18510	373	2067970	19041	241	22527720	14035	365
1717924	15455	330	20237057	12602	400	20687704	16624	415	22529733	2293	104
171-853-575A	13175	573	2024778	18938	256	20699808	14921	363	22529957	15992	395
171-853-585A	13175	573	2024781	8300	235	20712176	15463	340	22531616	11631	111
1729250	11485	398	20274997	12824	401	20713843	15684	248	22533245	16719	409
1731225	11481	398	20298365	11677	380	20-72-151	13219	575	22535007	15044	417
1732326	12315	430	20315425	12613	400	20-72-175	13220	534	22535311	16719	409
174610	16146	577	20319841	12731	368	20-72-175	13222	498	22536642	18298	362
1746408	18817	57	20325696	12656	251	2072728	8746	85	22537749	14220	396
1-74-713	12642	550	20328600	15467	341	20729447	18832	440	22537990	11252	392
1-74-820	19153	550	20331307	12568	420	20730529	18427	403	22538004	14753	411
17562	4260	327	20338568	13925	397	20731447	16886	64	22538004	14993	411
1758099	2752	579	20345137	14549	429	20734005	17092	380	22538102	14990	411
1758099	12960	579	20345381	15465	341	2074089	8971	611	22539532	15465	341
175-820-435	16252	99	20346654	14217	420	20743322	19808	253	22539533	15462	340
175-853-577-01C	13748	242	20348200	12315	430	20747508	17341	341	22542705	15045	417
175-853-577A	13753	242	20351035	12065	52	20747509	17159	341	22543363	17176	341
175-853-673	14013	575	20363491	13999	414	2075380	19055	235	22543915	15715	65
175-853-674	14014	573	20374473	12737	379	2076405	14169	608	22547243	15543	366
175-867-299	13475	574	20374473	14524	379	2084421	8774	153	22550254	17545	398
17635	20592	203	20376243	4441	328	2085119	16940	255	22566142	15684	248
1-76-651	13207	550	20387349	19789	379	2085119	19057	235	22566221	17106	414
176653	16134	577	20393536	14033	401	2085823	19060	235	22569178	18927	254
176-941-117A	15666	573	2040	19209	205	2096454	17115	159	22578985	18911	397
17916	20593	203	20413107	11612	363	2096466	14892	159	22579423	18927	254
17962-SA0-0030	14321	514	20418416	13855	420	2096467	15504	159	22580569	18328	253
179-813-881	14030	573	20421672	13752	242	21006725	18023	218	22585836	18912	253
179-813-883	12735	574	20421800	12992	380	21006951	18514	41	22587036	18310	417
179-813-883	14030	573	20423550	15774	29	21011332	12254	66	22587341	12081	246
17988147	16841	108	20423647	13747	242	21021319	18749	254	22595587	14988	441
17988488	14820	423	20426301	14260	568	21030249	17216	416	22599312	20263	401
17997722	14820	423	20429451	13992	380	21035018	14031	394	22600612	18930	376
1815	18474	202	20429500	14553	429	21035345	19297	413	22603044	19733	396
1816	16919	202	20430956	13858	420	21039129	17975	371	22603384	19820	407
1839906	18953	150	20432601	14219	370	21039141	17215	371	22607698	20357	378
18649-60556	18661	205	20432975	13748	242	21042045	17218	375	22615352	19732	396
18649-60556	20601	205	20433026	13753	242	21042053	17218	375	22637865	19360	404
1889	18003	202	20444103	13458	401	21042058	17218	375	22638717	13750	242
1891	18002	202	20448469	18430	403	21042098	17214	411	22641917	18912	253
1893	16909	202	20451119	13457	410	21042104	17218	375	22642007	19264	422
1895	16906	202	20451401	13461	379	21047094	16816	414	22642199	19362	404
1900654	9361	350	20451401	15461	379	21075387	19101	51	22642756	20262	368
192	20286	203	20451401	16017	379	21075686	17222	414	22643056	18889	256
193	18013	202	20452072	12567	413	21077123	19801	415	22644361	19522	414
193065	18474	202	20452072	13751	242	21077131	17616	418	22646099	19428	377
194	16902	202	20452072	13996	415	21077323	17226	414	22649878	11691	393

# O.E.M. INTERCHANGE BY NUMERICAL ORDER

O.E.M. No.	Auveco No.	Page No.	O.E.M. No.	Auveco No.	Page No.	O.E.M. No.	Auveco No.	Page No.	O.E.M. No.	Auveco No.	Page No.
22649879	11691	393	26024-H8610	16557	540	3426388	2272	466	3710401	9325	424
22651066	18930	376	26025-N8500	16549	541	34301-692A-0000	14317	505	3711168	4265	327
22657634	19787	411	2664040	14985	461	343543	11246	389	371964	19824	111
22657634	19788	411	271022	10773	81	343555	11243	389	3722635	2619	579
22658182	19008	407	27158-20100	17634	543	343555	11245	389	3722635	12958	579
22659122	19335	410	274004	18472	202	343555	11246	389	372741-S100	9864	212
22677979	20666	412	274007	18473	202	34355-SD2-003	15997	499	372820-S36	12654	256
22677980	20666	412	2745108	10262	462	3441734	12930	133	372820-S40	12654	256
22722859	20634	374	2793385	12751	199	3441743	12930	133	373415	9865	212
22722860	20635	397	27948-M7002	14348	544	3454220	15673	462	373528-S32	5854	101
230018	19943	481	279670	12523	85	3454221	15674	462	373846-S	12918	134
23472-S8	10377	23	279670L	12521	85	3455559	11253	392	3744734	10843	336
2357	17999	202	279670R	12523	85	3457	20587	203	3744750	12237	177
2357NA	18000	202	279671	12521	85	3457NA	20588	203	3744999	2752	579
2396	17998	202	2852065	20156	475	3467-531	19153	550	3744999	12960	579
24	18017	202	2889061	17116	159	347065	16237	99	3745361	4280	327
24NA	18018	202	293	18467	202	347347	13450	393	374985C1	9905	177
2409826	8742	85	2945108R	10262	462	347893	11292	103	3751212	12923	134
24100042	18663	219	2945109	10262	462	34903-SF1-A01	20297	203	375203-S	17467	250
24100042	20372	219	2945109L	10262	462	34906-S30-003	19207	202	375372-S	5592	374
2419255	8905	235	2962447	8774	153	34906-SL0-A01	20296	203	375480-S100	5195	101
24205245	20528	362	2962448	8777	153	34906-ST5-003	19207	202	375480-S102	5195	101
24220-89986	14345	548	2962510	11440	185	3496	20296	203	375890-S102	11293	100
24274-M3000	14346	548	2962574	17001	153	3497	20297	203	375936-S	17469	250
2448770	16873	590	2962953	17115	159	3509575	9905	177	3759944	18770	362
24574578	18686	363	2962984	8775	153	3512624-2	19249	577	3762180	4280	327
2477054	8895	234	2962987	8776	153	3513686	13542	197	376337-S100	9853	22
2486468	17434	465	2964547	11129	362	35178-30010	19319	217	376337-S100	9854	22
2495701	8938	235	2965142	15957	153	35178-50010	19319	217	376337-S100	9855	22
2496279	9905	177	2965470	14892	159	3518-274	17984	576	3764554	9469	424
25015169	12237	177	2965580	15504	159	3526573	19358	402	3764556	18414	158
2501569	12237	177	2965880	15503	157	352839	4258	328	3764863	12599	197
25016383	11612	363	2971962	15956	153	353123	1256	350	3764865	12598	197
25016383	11680	362	2973215	18690	155	3531990	18833	407	3767196	18979	335
25099299	20163	418	2973216	18651	155	3533539	16940	255	376785	15351	82
25117765	18925	181	2973385	12751	199	3533539	19057	235	376785-S2	15351	82
2524525	8419	454	2973932	9905	177	35336	15003	86	376842-F100	12261	83
2524526	16583	453	2974309	8756	178	35337	15004	86	376988-S2	10654	4
2534814	14461	611	2977373	11442	186	3536964	18663	219	3775994	18770	362
25500454	18210	400	2977373	13547	186	3536964	20372	219	3783002	5278	35
25501771	12136	392	2977607	11444	185	353745-S	2598	127	3783006	5228	38
25508532	12566	396	2977615	17001	153	3538281	19340	425	3783794	5195	101
25512081	12729	421	2978302	8755	177	3538469	18664	218	378527	17470	250
25512688	19162	106	2978302X	8755	177	3540146	17640	258	378527-S100	17470	250
25514221	11675	363	2984172	17117	159	3540146	18945	257	37888	12525	85
25522466	9285	227	2984375	17116	159	3540161	16940	255	37889	12524	85
25524005	14004	242	2984626	17117	159	3540161	19057	235	37891	12523	85
25525798	14220	396	2998430	10332	367	354076	11246	389	37892	12521	85
25526447	19435	396	2F1Z-9A317-AA	20482	446	3540858	18308	416	379046-S	8427	36
25527289	14822	103	2F1Z-9A317-BA	20483	447	354341-S	5196	101	379830-S	9862	435
25530441	14527	105	30006620	19257	566	3543865	19369	422	379830-S	14755	435
25535963	19472	419	30008324	19243	410	354400	12939	135	379830-S	14756	436
25536302	14820	423	30012018	14696	513	3547221	20433	393	379831-S	8814	108
25543684	18459	404	30066200	11642	64	3547382	18832	440	379831-S	10052	108
25551202	18946	254	3057	16915	202	3548011	17640	258	3799089	14858	462
25552852	18422	404	3057NA	16916	202	3548011	18945	257	380370	8418	39
25552853	18423	404	3065575	11796	380	3548690	17640	258	380382	9829	393
25552856	17979	402	3065575	16261	380	3548690	18945	257	380575-S2	8847	27
25554845	19361	398	3072505	11839	394	3548693	19363	397	380613-S	4439	133
25556181	16929	65	3078511	11130	371	3548804	18685	367	380614-S	4440	133
25556911	19166	106	3104-426	13173	573	357020	12918	134	380615-S	12209	133
255Y3616-10	12585	540	311-821-161	13219	575	3574085	11653	453	380707-S	11368	39
25600989	18459	404	3155	17997	202	357811	4246	327	380707-S	11370	37
25601491	18174	364	3156	17996	202	357-853-586-D	20250	574	380911-S2	16735	1
25603960	18389	362	3156NA	18475	202	358107	2272	466	3816659	10649	215
25604615	17548	398	3157	16917	202	358470	9361	350	381671-S	10642	28
25605716	14527	105	3157NA	18001	202	358501	8746	85	381801-S2	15774	29
25606274	19200	421	3157NASA	18476	202	358560	19626	578	381818-S2	9880	105
25606388	18421	402	3157SA	18479	202	358560	19627	578	381863-S2	9879	105
25609048	17641	254	32000404	18267	461	3588314	13541	197	38211-SD2-000	15932	175
25618359	19433	409	321-837-581-01C	14194	576	36000148	15666	573	38212-SE0-000	15933	175
25618730	17121	254	321-867-299B	20249	573	36001966	15666	573	382163-S	19826	103
25630330	19389	403	3230375	13472	447	362069	11638	53	38235-SA5-000	15934	175
25630331	19411	403	3236813	12927	135	362379	11245	389	382413-S2	17460	30
25630332	19412	404	3237451	12949	135	363137	15461	379	382413-S9	17460	30
25632157	19542	395	3239826	12935	133	363137	16017	379	382443-S	4439	133
25633289	18422	404	330485	19806	353	3652	20298	203	3828472	18329	253
25640501	3138	102	33111-SR3-A01	18661	205	365270	11718	390	383000	12929	133
25642453	17103	414	33111-SR3-A01	20601	205	3655015	4233	328	383000-S	12929	133
25646858	19835	413	33115-S84-A11	16897	204	3664645	4237	327	383001	12930	133
25647358	20584	394	332364	10831	365	3671410	12918	134	383001-S	12930	133
25648693	20280	405	332364	16259	365	367291	14976	98	383003-S	12937	133
25649667	20466	396	33303-S30-003	19206	202	367292	12995	97	383005-S	12931	133
25663903	20265	412	33303-SL4-003	19206	202	367292	12996	97	383016	12916	134
25672428	20279	380	3357	18477	202	3673945	12918	134	383031	12927	135
25680782	14991	411	3357NA	18478	202	3688699	8963	611	383033-S100	10780	350
25691949	20522	405	34201287	16826	36	3688811	4235	327	383033-S100	11863	350
25695687	19892	413	34201358	15331	64	3689084	4236	329	383033-S101	10780	350
25696693	19759	377	34201545	12293	551	3691590	10831	365	383033-S101	11863	350
25704001	20522	405	34201621	12567	413	3691590	16259	365	383142-S	20310	443
25704141	19758	377	34201631	18108	242	3693099	14217	420	383207-S	14217	420
25707329	20244	418	34201872	19276	455	3693292	4250	328	383229-S	11104	250
25718851	20326	406	34202159	17495	65	3696693	10843	336	383229-S	11105	250
25722671	20318	405	34202672	13993	415	37	18465	202	383229-S	11106	250
25762391	19758	377	34202839	18158	362	370247-S2N	5586	106	383255-S36	16770	82
26023-H1000	13931	541	342271	16253	99	370374-S	4248	328	383356-S	14756	436



# O.E.M. INTERCHANGE BY NUMERICAL ORDER

O.E.M. No.	Auveco No.	Page No.	O.E.M. No.	Auveco No.	Page No.	O.E.M. No.	Auveco No.	Page No.	O.E.M. No.	Auveco No.	Page No.
383569	8623	22	3923948	10090	392	4417599	8447	580	4778814	2818	578
383569	8624	22	3927320	9481	152	4428987	19155	372	4778814	12962	578
383569	8625	22	3944866	9965	578	4437565	12237	177	4779348	2943	578
383693	15338	82	3944866	12971	578	444613	9278	227	480001	14255	506
383847-S	11419	135	3946988	2710	1	444619	9279	227	4801268	3620	374
384111-S	12949	135	3963228	11738	134	444620	9279	227	4805119	19785	454
3843245	12598	197	3977775	11130	371	444667	9285	227	4805336-AA	19642	456
3843345	12628	164	3977775	15456	370	444776	9283	227	480534	10832	365
3843386	14893	158	3982098	8359	107	444777	9283	227	4805405-AA	19638	461
3843386	16349	158	3984469	10653	4	444782	9284	227	4805405-AB	19638	461
3843392	12627	164	3985058	11424	393	444789	9285	227	4805570-AA	20526	463
3843432	13233	197	3986978	10727	396	445429	11292	103	4851794	9921	353
3843601	14894	158	3986997	11109	27	4457495	10220	399	4853108	8398	580
3843601	16350	158	3989067	15460	424	4457595	10220	399	4857345-AA	20457	460
384432-S	19459	253	3997391	14030	573	4459049	9342	359	4860375-AB	20667	455
3846202	15783	26	3998009	15759	425	4486948	11157	178	4872948	4446	328
384931-S36	17035	27	380-868-243	20341	574	4490167	9477	409	4876498	10744	373
385189-S100	11620	248	4000141	11697	466	4492962	10318	401	4877000	8385	580
385189-S100	16837	248	4000155	8719	608	4492962	11288	399	4877001	8386	580
38529-689A-6300	14323	510	4001916	18508	373	4495047	9367	424	4878883-AA	20164	371
385323-S100	11621	249	4001934	13467	372	4498100	14552	465	4879431	9229	28
385323-S100	16838	249	4003120	13004	99	45262	10048	107	4879481	8448	580
385330-S	11136	374	4003672R	10262	462	45262	18898	107	4883164	8399	580
385353-S	12210	133	4003673L	10262	462	45263-S101	10050	107	4886720	8447	580
385400	15345	82	4004569	10831	365	45263-S2	10050	107	490067	11770	23
385661-S	11351	368	4004569	16259	365	45264	10053	107	490067	11771	23
385677	19425	373	4005099	11349	378	45264-S2	12265	107	4956-A	15017	87
385974-S	19460	255	4005237	16246	99	45265-S2	10054	108	4958	15016	87
3861577	11347	363	4005250	11350	370	45266-S2	9429	107	4962	15014	86
3861577	11679	363	4005470	11678	379	45266-S2	10047	107	4963	15015	86
386285	13472	447	4005540	11152	337	45267	10051	107	5007	20590	203
386299-S	16954	447	4005714	15813	466	45268-S2	8814	108	5008055-AA	20309	342
3863669	8942	393	4006204	11470	390	45268-S2	10052	108	5010366-AA	19791	468
386553-S	19655	371	4006211	13570	337	45269	10055	108	5012874-AA	19628	376
3866846	15345	82	4006316	13965	101	45332	15347	82	5020040-AA	20418	330
387042-S	12939	135	4006516	11612	363	45334	15345	82	5023111-AA	19804	377
387065-S	12932	135	4006529	15040	364	4533699	8583	337	5023351-AA	19804	377
387074-S	12933	135	4006848	12943	135	454626	16919	202	5027550-AB	20312	518
387182-S	11671	375	400764	4473	330	454645	16925	202	5027550-AC	20312	518
387258-S	11679	363	400765	4474	330	454646	18004	202	5028438-AA	20428	377
387466-S	12209	133	4019472	12943	135	455136	16920	202	5049604	19078	346
387477-S	11797	378	40224-21001	14253	85	455490	16918	202	51-11-1-908-077	20234	497
387496-S	11672	379	4033711	14552	465	4563173	4240	329	51-11-8-174-185	20248	497
3876130	16240	99	4040732	18509	373	4564974	4264	328	51-13-1-802-389-B	12642	550
387843-S	11705	443	4055028	13542	197	4565415	4240	329	51-13-1-804-205	13158	496
387944-S	11706	443	4072117	11110	27	458030	12316	430	51-13-1-848-312	13171	496
387980-S	12948	135	4081765	4188	327	45998051	12119	66	51-13-1-849-724	13163	496
388034	12919	134	4095145	12929	133	4630088	18028	242	51-13-1-869-959	16117	496
388047-S100	11852	248	409988	4417	322	4630088	18031	242	51-13-1-885-399	16115	497
388047-S102	12653	248	4100727	12932	135	4630253	18029	458	51-13-5-680-113	13159	497
388047-S1021	11852	248	4103165	14216	461	4630660	18031	242	51-13-8-124-389	20254	497
388047-S1021	12653	248	4104998	12937	133	4636359	18919	197	51-14-1-902-279	20186	497
388131-S	12925	134	4114785	12134	351	4636360	18921	197	51-18-1-821-830	18156	35
388246-S	11612	363	411700	11721	362	4636361	18920	197	51-18-1-852-299	13166	497
388248-S-36B	11768	103	411847	10827	394	4636362	18920	197	51-21-6-442-159	13167	497
388442-S100	12652	258	4124721	12598	197	4637277	20175	578	51-21-8-205-295	20388	497
388442-S309	12652	258	4-131-508.M	13230	532	4638136	14993	411	51-31-1-938-494	17279	496
388442-S309	19509	258	41-33-5-480-120	13164	497	4653672	3445	352	51-31-8-177-850	17279	496
388577-S	11146	366	4137121	4242	327	4654974	18397	352	513388	4243	327
388577-S	15414	366	413851	11252	392	4657731	2628	338	51-41-1-802-258	13170	497
388664-S100	14127	254	413945	8744	85	4658444	19191	463	51-41-1-973-500	20253	497
388904-S	20316	368	414187	11715	85	4658445	19190	463	51-47-1-840-960	20403	496
388908-S	14163	371	414188	19168	85	4658673	19149	362	51-47-1-840-961	13172	496
388916-S	12908	133	4157LL	20620	203	4658676	10262	462	51-47-1-928-808	20255	496
388930-S	12909	369	4157NALL	20621	203	4658676	20675	462	51-48-1-938-725	20270	497
389129-S	12907	133	416629	12069	355	4658677	10262	462	5149	15014	86
389138	12937	133	4167810	12920	134	4658887	20165	362	516637	8744	85
389144-S	17075	378	4179397	18840	137	465994	12945	135	51-71-1-916-197	17645	496
389258	10831	365	4179981	12946	134	4676189	19807	579	51-71-1-916-199	17646	497
389268-S-100	12658	249	4179982	12944	135	4676356	19339	463	51-71-8-108-613	20333	496
389358-S	10831	365	4198993	16729	464	4689929	2744	578	5201359	11848	453
389358-S	16259	365	4201198	12934	134	4689929	2818	578	5201359	11849	453
389360-S	11865	395	4234830	15518	425	4689929	12962	578	5208743	15040	364
3893980	10330	393	4241054	12939	135	4696129	18033	373	52161-02020	18873	570
389443-S	12571	368	4241296	12930	133	4696488	14995	411	52161-16010	18873	570
3895904	12923	134	4241362	12916	134	4696963	18826	368	52-20-8-238-999	13167	497
389809	13757	374	4270581	11848	453	4699315	2619	579	52466047	19077	346
3899596	14030	573	4274166	17117	159	4717224	19855	365	52466089	19080	346
390017-S2	15774	29	4275973	13465	461	4721222	4281	329	5255110	18979	335
390018-S	17664	366	4-29-29-06	13198	498	4723818	2789	579	528846	13004	99
3900684	4369	328	4304729	16804	158	4723818	12961	579	5297428	18952	150
3901067	19932	480	4307218	12943	135	472434	11699	413	53	16914	202
390126-S	14017	363	4314873	15681	334	472450	15453	329	53130	12657	255
390126-S	14857	363	4334140	11848	453	472812	12935	133	53145-16020	18846	560
390428-S100	17410	253	4334141	11848	453	472814	12921	134	53181	12654	256
390523-S	15675	450	4334142	11848	453	472815	12922	134	534343	11831	421
3907444	11719	39	4336115	17167	465	4730773	20175	578	53452-90351	17611	571
391304	1706	321	4341060	17004	371	474821	14976	98	53455-12060	20441	570
391304-S100	1706	321	4368163	16802	158	4755299	8435	38	53455-14020	14732	570
391305-S100	17607	321	4368618	15499	155	4755299	11719	39	53455-33010	19529	571
391396-S100	17604	321	4368960	16803	158	4759145	2943	578	53455-33011	19529	571
391397-S100	17605	321	4370138	17101	242	4759514-AB	20356	456	53879-14010	14750	572
3919773	11691	393	4381395	20316	368	4761842	2943	578	53879-14010	19669	572
3920179	11352	421	4395881	16113	498	4767559	4446	328	53879-14020	14750	572
3921446	9851	391	4400588	13542	197	477418	12249	66	53879-14020	19669	572
3921988	19130	218	4-40-13-10	13196	498	4778814	2744	578	53879-2		

# O.E.M. INTERCHANGE BY NUMERICAL ORDER

O.E.M. No.	Auveco No.	Page No.	O.E.M. No.	Auveco No.	Page No.	O.E.M. No.	Auveco No.	Page No.	O.E.M. No.	Auveco No.	Page No.
53879-22030	14750	572	6003409	20276	339	6033840	17664	366	63876-95596	16000	514
53879-60010	20335	569	6003423	11673	368	6033862	11349	378	63878-01E10	20348	547
53897-22030	14750	572	6003575	13615	457	6034213	10375	82	645350	1256	350
54229-0201P	16340	549	6003587	11675	363	6034336	19310	463	6466355	12920	134
545920	10401	106	6003609	12794	456	6034376	18373	218	6500092	12617	85
547944	4439	133	6003632	11936	457	6034703	18934	33	6500284	15329	64
549790	11640	54	6003647	12913	457	6034812	19310	463	6500361	14561	465
55	20282	203	6003752	20276	339	6034848	19657	251	6500526	12715	85
55022134	15042	417	6003858	13847	457	6034944	16988	243	6500650	15860	590
55055098	18248	374	6003861	13843	456	6035094	2562	82	6500651	15861	590
55075139	17214	411	6003873	13845	457	6035122	19751	253	6500722	15862	590
55075208	14562	465	6003878	13567	339	6035188	18934	33	6500725	14800	454
55134797	13570	337	6003878	20276	339	6035201	17639	257	6500787	14016	414
55156429-AA	20523	457	6003965	13927	457	6035201	19263	257	6500859	13754	242
55176248	14020	444	6004036	17151	457	6035204	18494	32	6500898	13755	242
55256967-AC	19816	335	6004162	17064	457	6035274	14037	396	6500911	13750	242
55275388	19815	335	6004212	14005	242	6035401	20179	454	6501025	12125	66
55275388-AB	19815	335	6006264	3404	83	6035414	19406	251	6501067	15481	367
55350747-AB	19775	377	6010029	19626	578	6035417	18373	218	6501086	20316	368
554343	11831	421	6010029	19627	578	6035807	19310	463	6501220	19718	59
556196	11665	390	6010046	2752	579	6035821	20524	455	6501301	16818	364
556539	11667	391	6010046	12960	579	6036042AA	19784	463	6501415	16980	66
556992	12932	135	6010093	2744	578	6036083-AA	20419	462	6501509	18242	242
557057	11655	390	6010093	12959	578	6036148-AA	20629	252	6501559	13751	242
557057	11871	391	6013029	2619	579	6036310AA	18163	85	6501577	17106	414
557057	12605	391	6013029	12958	579	60658-SB3-000	17289	516	6501590	14019	445
55799-12010	19841	560	6013122	11677	380	6100042	11629	110	6501630	17104	458
558	20288	203	6016247	12133	446	6100047	19216	64	6501699	17354	455
55914-S2	13021	33	6022582	16773	82	6100048	15329	64	6501772	17104	458
559312	11655	390	6023120	16929	65	6100049	15331	64	6501773	12569	436
559312	11871	391	6023171	10053	107	6100050	15333	64	6501825	12259	66
559547	11836	395	6023204	15345	82	6100539	12232	50	6501852	19266	458
56001419	15666	573	6023718	18811	234	6100567	19455	52	6501863	19241	378
56017580	14894	158	6023925	8242	39	6100568	15818	52	6501878	17104	458
56017580	16350	158	6025002	15342	82	6100775	12254	66	6501916	15543	366
560625	12937	133	6025004	15345	82	6100810	12115	66	6501925	18030	415
560692	11419	135	6025005	15347	82	6100811	12253	66	6501948	19893	364
561	18010	202	6025007	15350	82	6100814	19548	66	6502078	20456	362
562	20289	203	6025329	9480	26	6100815	16829	66	6502081	16871	590
562327	11831	421	6025502	9429	107	6100839	12122	66	6502083	16872	590
568792	19626	578	6025502	10047	107	6101283	11629	110	6502085	16873	590
568792	19627	578	6026166	16237	99	6101308	18449	109	6502087	16874	590
56910-S2	13025	29	6026430	9299	82	614	12629	164	6502089	16875	590
56911-S2	13711	29	6026686	10215	463	616	12628	164	6502090	16877	590
56911-S36	13711	29	6026723	10655	22	62217-13010	20558	565	6502091	16878	590
56912-S2	13026	30	6026723	10656	22	62228-51S00	19147	549	6502104	18771	369
56929-S2	13711	29	6026723	10657	22	622A2-9E000	20354	548	6502152	16846	109
57	16910	202	6026724	10078	23	622A2-9E000A	20354	548	6502328	14921	363
570	20290	203	6026724	10079	23	62318-01W00	16860	546	6502381	18815	363
57030-S36	17034	25	6026724	10083	23	62319-0W000	20266	541	6502450	16876	590
5706	15018	87	6026815	16535	25	62350-01M00	14729	546	6502491	16870	590
5715	15017	87	6026958	10086	82	62350-M7060	14729	546	6502545	18237	461
5716	15015	86	6027221	14999	25	62380-U7400	17196	543	6502573	18032	458
57172C91	11156	178	6027924	10080	463	62581-14020	16778	564	6502625	16835	412
5735-L	15004	86	6027958	19485	536	6263345	11138	398	6502689	18501	242
5735-R	15003	86	6028993	14562	465	6264396	16246	99	6502738	17353	85
574355	19626	578	6029348	16852	82	62660-48600-1	20381	508	6502745	16868	590
574355	19627	578	6029501	12735	574	62698-V7000	14313	524	6502776	18102	448
575411	2789	579	6030441	11146	366	6270163	10832	365	6502842	17975	371
575411	12961	579	6030441	15414	366	6271989	14559	427	6502871	14992	442
577	18009	202	6030538	10832	365	6272766	12918	134	6502907	17669	376
57754GA190	16545	551	6031091	11621	249	6280765	3617	359	6502907	18915	376
57754GA191	16545	551	6031091	16838	249	62869-N4700	14723	544	6502988	19519	422
588546	15037	28	6031115	11620	248	6288704	8777	153	6502991	17685	376
591-740	12637	576	6031115	16837	248	6292995	15372	164	6503106	18269	460
5949838	3178	392	6031147	8865	82	6292996	15371	164	6503108	18034	454
5963268	11156	178	6031183	14218	455	6292997	18773	164	6503163	14997	411
5970995	16230	97	6031234	13647	454	6293702	15370	164	6503169	18532	64
5973400	12757	413	6031321	10831	365	6293923	16935	164	6503174	19794	464
5973823	19847	413	6031383	11704	459	6294493	12564	153	6503204	18862	376
5973996	12756	414	6031390	11699	413	6294493	13548	186	6503221	12766	368
5973996	15042	417	6031438	12995	97	6294511	15936	155	6503274	18035	461
5988-L	15010	86	6031438	12996	97	6294512	11947	155	6503339	18249	461
5988-R	15009	86	6031495	16538	30	62955-12010	15695	553	6503373	18825	455
5BB14LX9	19245	460	6031551	19437	351	62955-20020	15695	553	6503401	19417	60
5FR56DX9	19894	457	6031644	16537	25	6298886	9883	177	6503433	18375	219
5GC71RC3AA	20273	443	6031869	12713	551	6298886	11166	177	6503453	18394	461
5GF92RC3AA	20273	443	6031875	19152	463	6298886	13558	177	6503454	18327	459
6000258	19537	101	6032061	12566	396	6298892	9883	177	6503598	17216	416
6000558	10073	101	6032083	16851	82	6298892	13558	177	6503709	19213	375
6000605	5854	101	6032138	16687	252	6298935	9883	177	6503768	18301	364
6000705	2619	579	6032363	11351	368	6299087	11157	178	6503800	13748	242
6000705	12958	579	6032516	13466	454	63	20283	203	6503812	19779	464
6000720	2752	579	6032838	14979	448	631	18468	202	6503819	19417	60
6000720	12960	579	6032838A	14979	448	63844-01A00	16858	547	6503837	18531	81
6000943	9377	551	6032856	17615	251	63844-01A99	14726	546	6503860	17101	242
6002893	10622	339	6032926	12655	249	63844-D0100	14727	548	6503892	18827	374
6002893	11611	339	6032926	14486	249	63848-01G00	16782	513	6503938	18913	242
6003147	11354	457	6032975	14562	465	63848-35F00	19735	549	6503943	20189	367
6003219	13616	457	6033018	20332	363	63848-40Y00	20613	547	6504014	17669	376
6003220	8853	373	6033082	17664	366	63848-9E001	20327	547	6504014	18915	376
6003349	11678	379	6033376	16995	453	63848-D0100	17193	549	6504018	19141	220
6003351	11136	374	6033560	15345	82	63848-D4000	17385	549	6504043	17612	366
6003368	11701	379	6033677	14756	436	63848-D4001	17385	549	6504072	19793	455
6003409	13567	339	6033688	18810	256	63854-01A00	17472	547	6504090	12567	413

# O.E.M. INTERCHANGE BY NUMERICAL ORDER

O.E.M. No.	Auveco No.	Page No.	O.E.M. No.	Auveco No.	Page No.	O.E.M. No.	Auveco No.	Page No.	O.E.M. No.	Auveco No.	Page No.
6504098	19338	370	71592-S5D-000	20603	499	7693140	9639	337	8913369	14885	160
6504135	19541	367	71593-SM4-003	18200	499	76988-3J000	19736	543	8914822	11475	179
6504424	18375	219	71593-SM4-0030	18200	499	7698976	9633	337	8914823	11476	178
6504521	19422	460	71598-S30-013	20677	499	76996-01P02	16776	509	8915135	12629	164
6504601	19779	464	71807-SLO-000	19423	489	76997-P7100	14723	544	8915136	12628	164
6504700	13750	242	72175-SH3-003	20329	515	7703-077-066	12993	551	8917225	18451	159
6504870AA	19809	456	72311-S10-003	19673	511	7724826	4447	328	8917283	17002	153
6504980AA	19540	367	72413-SF1-003	17270	500	7730788	9749	337	8917320	14547	419
6505049AA	20317	463	72413-SF1-0030	17270	500	7731589	9850	400	8917444	11083	167
6505149AA	18531	81	72727-W1000	15470	540	78856-R4301	14690	507	8917528	15959	155
6505161AA	19640	454	72774-01F00	14331	541	796255	11349	378	8918527	9883	177
6505292AA	19386	376	72826-01P00	15468	540	79796-71E00	17349	540	8918527	11166	177
6505319AA	19792	462	73	20284	203	79896-P7100	14333	540	8919916	13543	179
6505417AA	19836	362	73156-SS0-004	17488	505	800843	12935	133	893	20599	205
6505539AA	19628	376	7368261	16801	158	801471	12922	134	8934-201-235	13464	551
6505703AA	20267	455	73856-51E00	17348	540	801-853-577	12635	573	8934-201-262	11855	551
6505759-AA	20427	377	73862-672-003	14299	511	801-867-299/041	13202	574	8934-201-263	9377	551
6505813AA	18934	33	73862-672-0030	14299	511	803716-S	14018	444	8934201287	16826	36
6505863AA	20420	462	74	18016	202	803-853-139A	13189	573	8934-201-493	16256	99
6505918-AA	20515	376	74144-SR3-000	19624	329	803-853-139C	13174	573	8934-201-602	12713	551
6506005AA	20361	364	7440	19206	202	803-853-213	13185	574	8934-201-681	13475	574
6506008AA	19639	415	7443	19207	202	80866-01A00	16822	540	8934-201-767	13966	551
6506104AA	20173	464	74798-S9000	14695	507	80871-ST7-000	18141	321	8934-201-835	17496	242
6506132AA	20458	460	74806-SB6-003	16825	505	80872-ST7-000	18140	321	8934-202-078	15495	242
6506293AA	20361	364	74807-SB0-004	17454	504	80873-ST7-000	18137	321	8934-202-293	16251	99
6506306-AA	20623	462	74842-659-003	16779	510	80874-0P000	20673	542	8934-202-428	17100	378
6506311-AA	20622	376	74842-659-0030	16779	510	80875-85E00	18166	545	8934-202-599	17102	375
6506852AA	20468	455	75039-33010	19482	519	80897-10Y00	19738	546	8936000	15666	573
6506853AA	20467	375	75039-33040	19492	518	80999-05N07	16784	570	8936001	15666	573
6507219-AA	20436	54	75039-33060	19120	519	81121-14670	16558	552	894	20684	204
65624-V0100	14337	548	75049-33010	17989	518	81121-17010	16558	552	8941340270	14739	559
65810-K2009	19724	545	75049-33020	19119	519	81124-89101	16951	552	8941455150	17076	518
65832-F5000	17237	544	7506	20592	203	81126-37010	20543	516	8-94215-211-0	19229	494
65846-30F00	17237	544	7528	20593	203	81127-01010	17352	560	8942180270	17195	499
65846-40F00	19468	517	75307-SN7-000	20570	516	81132-32121	17352	560	8942211500	14727	548
66435-648-000	14291	508	75395-14020	14264	554	812893	12600	179	8942264920	14269	567
66435-648-0000	14291	508	75395-33030	19900	519	8133-50-022	14380	526	89427-98070	16775	509
6654	15016	87	75397-33010	20661	519	8173-50-931	12589	523	8942981190	14696	513
66814-01G00	16725	548	75397-48010	19899	519	823-867-299	20252	574	8944674584	17355	517
66820-3S500-C1	20672	545	75397-48030	20605	519	82520-E6000	14336	546	8-94467-458-5	19227	490
66820-3S510	20614	540	75398-20050	19671	553	83501000	12599	197	8956001	15666	573
66820-88E00	17633	543	75498-42010	19843	553	83504040	19319	217	8-97098-397-0	19230	494
66824-01G00	16783	546	75521-611-000	14274	506	83504041	19318	221	8-97134-978-0	19227	490
66824-W1000	14725	548	75521-611-0000	14274	506	8411	15018	87	89721-48720	18661	205
66860-01W01	16859	546	75522-611-000	14255	506	84653-N7400	14337	548	89721-48720	20601	205
67	16905	202	75522-611-0000	14255	506	84915-0W000	19731	545	89728-69970	16897	204
673-988-00-25	20315	531	75545-12050	15475	554	85099-0B720	19293	542	90	18015	202
67771-01010	14144	567	75545-14081	14747	558	85284-AD005	20674	540	90001-SG0-003	14291	508
67771-02030	15709	567	75545-16020	14751	558	8545-50-786	14362	524	90009-PY3-000	20426	219
67771-02030	19898	567	75545-20060	17300	555	8717859	10243	338	9003	18661	205
67771-03030	15707	567	75545-24030	19776	519	8731909	3620	374	9003	20601	205
67771-04040	19210	568	75545-28010	14749	558	8731909	11120	362	9004	16896	204
67771-06010	18844	566	75545-32020	16833	554	8733059	10318	401	9005	16897	204
67771-12010	14269	567	75545-32030	17485	555	8733059	11288	399	9005LL	20682	204
67771-12010F	14269	567	75545-88080	14749	558	8734067	10242	337	9006	16898	204
67771-12030	15709	567	75545-880B0	14749	558	87756-38000	20567	516	9007	18662	204
67771-12040	19016	568	75545-89101	16942	558	87756-2D000	20566	516	90075-10801	19783	559
67771-12050	19257	566	75545-89102	17303	555	87758-3D000	20568	516	90075-10805	19783	559
67771-12070	20473	565	75545-89103	17302	555	8799350	10617	400	90080-46199	19015	566
67771-12080	20575	566	75546-12010	12587	556	880	20594	205	90080-46269	19797	553
67771-14040	15707	567	75546-12020	16820	558	881	20595	204	90082-35011	17483	57
67771-16080	19108	567	75546-12030	16821	558	885	20596	205	90084-26000	17420	247
67771-16120	18874	568	75546-12050	14746	556	886	20683	204	90084-26002	20383	252
67771-16160	18874	568	75546-12060	19204	554	8880417	15672	458	90084-26008	17411	247
67771-16170	18875	565	75546-20060	17301	555	88891731	19424	427	90099-14044	18136	321
67771-20110	19256	567	75546-22050	14745	557	88891791	18889	256	90099-14045	18143	321
67771-22010	14270	567	75546-22060	17334	555	889	20597	204	90106-SW3-003	19650	508
67771-22020	14728	565	75546-89103	19491	557	88909769	12547	174	90107-S10-003	19533	508
67771-28020	20174	567	75547-22010	17298	556	88969790	20576	564	90107-SX0-003	19734	508
67771-30070	19109	565	75548-16010	17330	556	88970345	20559	565	90108-SS0-003	20331	499
67771-30090	19129	568	75548-16030	16819	556	88970494	20577	569	90108-SW3-003	19470	509
67771-32090	18844	566	75548-20060	17332	556	88970495	20578	554	90109-SW3-003	19470	509
67771-89104	19203	565	75548-22150	19484	557	88986451	18868	181	90113-SLO-T01	17417	247
67772-16020	19488	570	75548-24020	14278	556	89	16911	202	90114-SE0-000	20259	58
67867-0C010	20443	564	75548-32010	14731	556	8900444	14752	185	90116-S82-A01	19439	499
67867-12150	19749	564	75548-89102	14744	557	8900524	11948	155	90157-SP0-901	19226	499
67867-28030	18692	564	75548-89103	14744	557	8901283	11166	177	90179-05060	17993	522
67867-89103	18692	564	75791-0W010	15707	567	8902487	11446	178	90183-03001	16306	572
67868-89101	18692	564	75867-21010	20576	564	8903283	11446	178	90189-04008	14277	560
67921-32010	19719	565	75867-30110	19842	563	8903488	12629	164	90189-04011	14271	559
68	20292	203	7634583	9275	337	8903488	15372	164	90189-04013	14268	507
680-097	13191	576	7637192	4441	328	8903489	12628	164	90189-04014	14256	559
68211-06020	19531	554	7642589	13467	372	8903489	15371	164	90189-04019	14263	560
68211-07010	19380	554	76848-35F00	19685	542	8904437	11156	178	90189-04022	17224	558
68211-32040	19198	554	76848-35F20	20168	542	8905087	15959	155	90189-04031	18843	560
68211-95D00	19722	554	76848-50Y00	20257	542	8905794	20471	419	90189-04057	14271	559
68425-H5000	14313	524	76876-VW5000	14352	543	8909518	11156	178	90189-04063	14740	559
69293-12030	20469	571	76881-0P000	20166	543	8909908	11446	178	90189-04066	14281	507
69293-12040	20470	571	76881-9E000	19897	541	891	20598	205	90189-04127	20442	559
69293-12050	20534	521	76882-0B000	19432	546	8911472	14546	419	90189-04150	19265	559

# O.E.M. INTERCHANGE BY NUMERICAL ORDER

O.E.M. No.	Auveco No.	Page No.	O.E.M. No.	Auveco No.	Page No.	O.E.M. No.	Auveco No.	Page No.	O.E.M. No.	Auveco No.	Page No.
90189-05082	19187	560	90467-09101	18939	521	90668-688-003	14296	506	91501-S1K-003	20609	509
90189-05105	20431	559	90467-09127	19739	569	90668-SB0-003	14698	513	91501-S5A-003	20340	500
90189-06001	14275	560	90467-09138	17990	520	90668-SP0-003	19448	496	91501-S5D-A01	20340	500
90189-06003	14266	561	90467-09139	19416	570	90669-671-000	14284	515	91501-SG0-003	17440	489
90189-06005	14273	561	90467-09143	17988	521	90669-671-0000	14284	515	91501-SL4-003	19467	493
90189-06006	14265	560	90467-09145	17206	568	90669-671-003	14284	515	91501-SM4-003	17205	510
90189-06010	14274	506	90467-09158	20439	565	90669-SB0-003	19487	536	91501-SM5-A00	19680	500
90189-06013	14267	561	90467-09206	20437	566	90669-SP0-003ZA	19744	509	91501-SP1-003	19225	489
90189-06018	14258	559	90467-10018	14347	544	90670-692-003	16781	509	91502-S84-A11	19683	511
90189-06028	19194	561	90467-10077	19797	553	90670-SG0-003	19741	507	91502-SG0-003	17445	492
90189-06029	19505	560	90467-10096	19534	562	90671-SB3-003YF	19674	509	91502-SM4-000	17143	514
90189-06042	14695	507	90467-10107	19123	564	90671-SX3-003YF	19674	509	91502-SM4-000	19407	514
90189-06065	20440	561	90467-10123	19014	562	90672-671-003	18157	508	91502-SP0-003	18119	512
90189-06104	19742	561	90467-10146	19728	568	90672-671-8110M1	14268	507	91502-SZ5-003	19232	495
90189-06111	19783	559	90467-10152	19534	562	90672-692-003	14279	515	91503-S0K-A01	20608	513
90189-06114	20412	561	90467-10161	18876	566	90672-SA0-003	14298	515	91503-SK7-013	19723	493
90189-06116	19505	560	90467-10162	18861	565	90672-SA0-0030	14298	515	91503-SP0-003	17267	496
90189-06157	19721	561	90467-10167	20559	565	90672-SA6-003	14700	504	91503-SZ3-003	19233	495
90189-06162	18747	552	90467-10168	18950	566	90672-SA6-0030	14700	504	91503-SZ3-003	19233	495
90189-06214	19756	561	90467-10173	19123	564	90673-692-003	14286	512	91503-SZ5-003	20564	513
90212-SA5-003	16470	516	90467-10188	20633	566	90673-692-0030	14286	512	91503-SZ5-003	20564	513
90269-03046	19059	235	90467-11063	17481	553	90673-SC6-003	14703	504	91504-SM4-000	17144	514
90269-04050	20628	251	90467-11100	20429	553	90673-SC6-0030	14703	504	91504-SM4-000	19408	514
90269-04053	20627	251	90467-11111	19647	553	90674-692-003	12580	502	91504-SP1-003	19507	489
90269-05054	20626	254	90467-12070	20662	519	90674-692-0030	12580	502	91504-SR3-003	20432	514
90319187	19434	532	90467-12078	16779	510	90674-SA5-003	14293	512	91505-SG0-003	17280	504
90341-10006	19318	221	90467-12078-01	16779	510	90674-SA5-0030	14293	512	91505-LO0-003	19231	495
90341-10012	19318	221	90467-12096	14277	560	90674-SC6-003	15474	504	91508-S50-003	19547	512
904	20291	203	90467-13005	17194	553	90675-692-003	14306	500	91508-SM4-003	17192	512
90418-SW3-003	19470	509	90467-13011	17195	499	90675-SA6-003	14294	506	91508-SR3-000	18165	512
90430-12019	17628	217	90467-17004	17438	553	90675-SA6-0030	14294	506	91509-SM4-000	19150	499
90430-12028	17628	217	90468-04030	16671	572	90675-SB3-003	16000	514	91509-SR3-003	18455	501
90430-12031	18849	217	90468-04038	16306	572	90676-671-003	14316	509	91510-SR3-003	17981	500
90463-10024	14279	515	90471-PX4-000	16955	217	90676-671-0030	14316	509	91511-SP0-003	17324	489
90463-10337	14284	515	90505-SL0-003	19140	569	90676-SA7-003	17058	506	91511-SR2-004	19223	502
90463-10338	14735	571	90505-SM4-003	17057	514	90676-SD2-003	17268	492	91511-SR3-003	17474	503
90467-05045-22	19686	562	90505-SX0-003	19453	512	90676-SR4-003	18115	508	91512-SE0-003	18512	514
90467-05096-22	19312	562	90520-01002	2288	336	90677-671-003	14687	515	91512-SJ6-J01	19544	511
90467-06017	14260	568	90520-01274	2288	336	90677-SEE-003	16950	515	91512-SM4-003	17379	514
90467-06017-20	14260	568	90541-15004	19625	329	90679-692-003	14308	500	91512-SP1-000	18762	492
90467-06017-41	14260	568	906	16922	202	90679-692-0030	14308	500	91512-SR3-004	20472	508
90467-06070-B1	20438	562	90601-SH3-014	17442	500	90681-693-000	14280	507	91512-SX0-003	19239	512
90467-06092	17991	520	90601-SK7-003	18759	490	90681-693-0000	14280	507	91513-SE0-003	18818	511
90467-06133-CO	20196	568	90602-S7S-003	20611	510	90682-SB0-003	17058	506	91513-SM4-000	17096	500
90467-06138	19720	568	90602-S84-A01	20330	515	90683-693-000	14690	507	91513-SP0-003	17323	489
90467-06150	19490	569	90603-S7S-003	20612	507	90683-693-0000	14690	507	91513-SP1-003	18755	490
90467-06161-01	14736	563	90605-SF1-003	17089	501	90683-SA5-003	19311	513	91514-SP0-003	18764	491
90467-06175	19643	562	90606-SF1-003	17321	505	90683-SA6-003	14685	502	91514-SP1-003	18760	492
90467-07041	17162	569	90610-SF1-003	17082	501	90683-SA6-0030	14685	502	91515-SR3-000	19483	511
90467-07041-B2	17162	569	90611-SF1-003	17473	501	90683-SC6-003	14685	502	91515-SR4-003	19737	500
90467-07043	16784	570	90611-SK7-003	18763	490	90683-SC6-0030	14685	502	9151649-2	20405	576
90467-07043-11	16784	570	90612-SF1-003	17320	501	90684-SA5-003	14695	507	91516-SK7-013	17350	512
90467-07043-C0	16784	570	90612-SK7-003	18765	491	90684-SA5-0030	14696	513	91516-SM4-013	19116	511
90467-07044	19128	569	90621-SK7-003	18756	490	90685-SA5-003	14356	544	91518-S10-003	19682	510
90467-07045-22	20430	562	90651-SL9-013	19454	508	90687-671-003	14319	510	91518-SM4-003	19114	510
90467-07050	14737	563	90651-SL9-0130	19454	508	90687-671-0030	14319	510	91519-S5A-003	20387	503
90467-07059-22	19013	570	90652-SB2-023	16949	514	90687-SA5-003	14282	508	91519-S5P-A01	20385	503
90467-07066	17383	412	90654-SA4-003	19730	515	90687-SA5-0030	14282	508	91519-SR3-003	19513	501
90467-07076-C0	17162	569	90655-SA0-003	14288	505	90687-SB0-003	17287	513	91520-S5A-003	20386	503
90467-07080-B2	20305	562	90655-SA0-0030	14288	505	90687-SB0-013	17287	513	91520-SM4-C01	18114	510
90467-07096	19124	563	90655-SB2-003	17283	508	90688-SB0-003	14698	513	91520-SM4-C010	18114	510
90467-07117	18270	521	90656-671-6310M1	14287	506	90688-SB0-013	14698	513	91520-SR3-003	17475	503
90467-07121	19908	569	90657-SA6-003	14697	513	90692-SA5-0030	14290	511	91521-S5P-003	20384	503
90467-07121-B2	19907	569	90657-SA6-0030	14697	513	90694-SB0-003	17281	504	91521-SR3-003	19512	501
90467-07126	19535	562	90657-SB0-003	19186	512	90694-SB0-0030	17281	504	91524-SE0-003	17081	513
90467-07131	18841	563	90658-SB0-003	14701	502	90700-SB2-003	15998	509	91524-SM4-003	17286	503
90467-07138	17992	521	90658-SB0-0030	14701	502	90700-SJ4-000	18746	494	91524-SM4-A11	17286	503
90467-07146	19552	568	90661-SC7-003	14695	507	90713-SB0-003	14705	504	91525-SM4-003	17285	502
90467-07166	18888	578	90661-SC7-0030	14695	507	90866-SA0-000	20350	506	91526-SM2-004	18112	505
90467-07168	20577	569	90661-ST7-003	18456	492	90901-89004	20660	520	91526-SM2-004	17203	505
90467-07168-C1	20577	569	90662-671-003	14313	524	90904-67021	19430	553	91526-SP0-003	18768	491
90467-08004	18297	563	90662-671-0030	14313	524	90904-67036	20390	553	91526-SP1-003	18767	492
90467-08008	14737	563	90662-693-003	14281	507	90904-67037	20391	553	91527-SM4-003	19415	500
90467-08011	18297	563	90662-693-0030	14281	507	90950-01248	16777	563	91527-SP1-003	18757	491
90467-08011-83	18297	563	90662-693-0031	14281	507	90950-01911	19583	562	91527-SZ3-003	19415	500
90467-08014	19121	562	90664-671-003	14328	511	90959-01136	17631	571	91528-S01-A01	19115	505
90467-08014-01	19121	562	90664-671-0030	14328	511	90981-13055	18661	205	91528-SP1-003	18758	491
90467-08081	18878	564	90664-692-0300	16861	505	90981-13055	20601	205	91528-SR4-003	19115	505
90467-08122	19122	563	90664-SB0-004	15472	504	90982-08188	15926	175	91528-SU0-003	18866	502
90467-08124	19113	520	90664-SB3-003	20303	507	90982-08189	15927	175	91529-SS0-003	18865	480
90467-08155	19140	569	90665-SA0-9700	12576	499	90982-08202	15930	175	91530-SE0-003	14328	511
90467-08179	19910	566	90665-SM4-000	19646	507	90982-08203	15931	175	91530-SP1-003	18877	511
90467-08184	19727	561	90666-SA0-003	14289	509	90982-08223	15929	175	91530-SS0-003	18864	502
90467-08186	20184	562	90666-SA0-0030	14289	509	91GBA611A08EAW	18387	447	91530-ST5-003	19116	511
90467-08186-C0	20184	562									

# O.E.M. INTERCHANGE BY NUMERICAL ORDER

O.E.M. No.	Auveco No.	Page No.	O.E.M. No.	Auveco No.	Page No.	O.E.M. No.	Auveco No.	Page No.	O.E.M. No.	Auveco No.	Page No.	
91545-SE0-003	16782	513	9414767	2734	1	9437938	11621	249	96706-89901	14366	542	
91545-SE0-003-W1	16782	513	9415465	2366	3	9437938	16838	249	96706-B0700	13930	541	
91547-SE0-003	14688	514	9416042	2712	1	9438068	18012	202	96706-B6700	13930	541	
91547-SE0-0030	14688	514	9416444	2709	1	9438068	19612	207	96706-H2500	14724	542	
91550-SH3-003	19142	513	9416927	16909	202	9438150	11246	389	96706-H9400	14335	542	
91558-SE3-003	19672	515	9417276	1937	3	9438848	16907	202	96706-K1300	14335	542	
91560-S84-A11	20411	510	9417561	20285	203	9438850	16908	202	96706-K1351	14335	542	
91560-SM4-003	20610	510	9417863	16906	202	9439559	18749	254	96706-N8000	14334	541	
91560-SF0-003	19145	510	9417866	16904	202	9439702	20290	203	96706-P0105	14274	506	
91560-SZ3-003	19466	494	9417866	19608	207	9439719	12657	255	9685057	11678	379	
91561-S84-A01	19415	500	9419322	13022	32	9440034	15511	27	9685057	15461	379	
91561-SE3-003	20304	508	9419740	5655	2	9440178	9879	105	9685057	16017	379	
91561-SW5-003	19479	492	94198687	14697	513	9440375	17409	247	97		16912	202
91562-SV4-003	18405	501	9420052	12097	57	9441592	18167	249	9711304	15759	425	
91566-SF0-003	18294	511	9420262	10669	83	9441721	18009	202	97134978	17355	517	
91568-SL4-003	17608	492	9420850	11923	3	9441724	20598	205	9716926	14549	429	
91568-SR2-003	19171	511	9421330	16902	202	9441725	12083	246	9721917	14550	429	
91570-SK7-003ZF	19546	513	9421330	19611	207	9441731	16896	204	9727078	11426	400	
91570-SKF-003ZF	19546	513	9421777	16912	202	9441732	16897	204	9727274	4244	328	
91572-SV2-003	19224	503	94218027	17195	499	9441733	16898	204	9731301	11152	337	
91572-SV4-003	18404	504	94221150	14727	548	9441770	8938	235	97606-B0700	13930	541	
91573-SV4-003	18403	503	9422202	13708	28	9441837	18017	202	9786454	9354	23	
91574-SV2-003	19478	501	9422246	13707	28	9441838	18000	202	9786454	9355	23	
91574-SV4-003	18406	501	9422339	18469	202	9441839	16915	202	9786454	9356	23	
91575-SL4-004	18235	489	9422552	11292	103	9441840	16916	202	9795883	10068	23	
91576-SV4-003	19477	501	94226492	14269	567	9441854	17998	202	9796223	10714	34	
91577-SV4-003	19476	501	9423950	15827	31	9441866	17999	202	979878-6	19376	252	
91578-SV4-003	18457	499	9424837	9880	105	9441923	18018	202	9808241	10630	338	
91589-SV4-003	20272	500	9425491	9881	105	9441941	2808	3	9815325	14967	425	
916	18006	202	9425542	16921	202	9441955	19796	258	9818648	10621	379	
916NA	18007	202	9426331	12547	174	9441956	18005	202	9822198	14548	429	
91604-SD2-013	18454	515	9426334	12545	174	9442003	17996	202	9837022	10401	106	
91619-SM4-003	19117	506	9427587	18013	202	9442081	17997	202	9838109	10318	401	
91619-SM4-0030	19117	506	9427761	10666	103	9442361	17641	254	9838109	11288	399	
91620-SR2-003	19307	507	9427882	9282	227	9442468	17431	254	9839085	13437	209	
91623-SM2-003	19143	508	9427909	8925	235	9442486	18001	202	9854717	10243	338	
91623-SM2-0030	19143	508	9427943	20289	203	9442492	18478	202	9854717	10631	338	
91626-SH3-003	19741	507	9427977	13709	32	9442876	20594	205	9883583	10621	379	
91635-SM4-003	17609	506	9428273	13027	31	9442878	20596	205	9883583	11774	379	
91637-SE3-003	20445	506	9428481	3796	103	9442880	20597	204	9883583	16260	379	
91641-SH3-013	19679	507	9428902	16899	202	9442881	20599	205	9895598	10701	338	
91651-SZ3-003	19463	493	9428902	19609	207	94467458	17355	517	9924-90-512B	14367	525	
91652-SF0-003	19465	493	9428904	16901	202	946-418	13220	534	9926-40-531B	18271	526	
91652-SZ3-003	19746	494	9428904	19610	207	947-098	13230	532	9926-40-543A	14349	543	
916581	9884	187	9431647	2293	104	94841226	14750	572	99265-0625	14260	568	
916581	9885	187	9431808	16913	202	94842841	18297	563	9926-50-635	14369	528	
916632	9916	187	9431809	18011	202	94847334	17383	412	9927-40-821	14363	527	
916638	9884	187	9432137	16687	252	94848189	18330	373	9927-40-822	16778	564	
916638	9885	187	9432552	16686	251	94848192	18330	373	9927-40-825	14269	567	
917	20293	203	94328493	17149	410	94848834	15695	553	9927-70-901	14378	528	
921	18005	202	9433040	18010	202	94849113	18297	563	9927-80-404	14365	529	
922	20294	203	9433043	11628	110	94852368	19140	569	9927-80-405	14359	528	
92470-N8200	18135	321	9433143	20286	203	94858299	18876	566	9928-90-753	14376	529	
92470-N8210	18135	321	94331546	20582	105	94858338	19312	562	9928-91-053	14298	515	
92471-N8200	18139	321	9433155	9879	105	94858343	19726	410	9956-41-400	19621	217	
92472-N8200	18134	321	9433156	20582	105	94858864	19645	410	99604-H1400	16780	571	
92473-N8200	18142	321	9433159	16840	105	95005064	14144	567	9991-00-402	14366	542	
92474-N8200	18138	321	9433184	18016	202	95008221	19129	568	9991-00-403	14364	524	
92475-W1000	18140	321	9433185	17653	255	95188	15011	86	9991-00-412	13930	541	
92475-W2100	18144	321	9433186	18168	255	95900-04036	17224	558	9991-00-501	14357	524	
93	16926	202	9433373	10171	1	95900-08025	17352	560	9991-00-503	14313	524	
93560-54016	17483	57	9433489	11614	22	9590477	12675	85	9991-00-601	14274	506	
93904-46320	16960	36	9433489	11615	22	9591699	12695	85				
94051993	16859	546	94340505	17985	375	9591855	19168	85				
94109-14000	16956	217	9434229	18732	235	96057846	17162	569				
9411017	9265	223	9436175	11620	248	96057847	17383	412				
9411019	9266	223	9436175	16837	248	96061699	14367	525				
9411022	9257	222	9436750	16922	202	96061863	17356	422				
9411031	9260	222	9436789	18465	202	96064506	19128	569				
94113207	17271	395	9436790	20284	203	9617200	11118	408				
9411943	3401	83	9437173	18008	202	9624520	11066	337				
94145515	17076	518	9437486	12655	249	9662505	13437	209				
9414716	3079	3	9437486	14486	249	9662548	17233	409				
9414722	1943	3	9437643	20402	249	9662950	11067	337				
9414723	2808	3	9437846	14486	249	9669486	11855	551				

**Specifications and application information have been researched using reliable sources to obtain the most accurate listings; however, Au-ve-co does not make or imply any warranty concerning the accuracy of the information. Au-ve-co does not accept responsibility for errors, omissions or changes or for harm resulting therefrom. Warranty is limited to the replacement of product only. All information contained in this catalog supersedes all information in previous catalogs.**



# FasTrack™ Cost Recovery System

**Auveco's FasTrack is a user-friendly program designed to assist collision repair shops in recovering the cost of the trim clips, moulding clips, and fasteners used in body repair.**

Previously, the cost of fasteners used in collision damage repair was often an expense that was not recovered by body repair shops. As the insurance companies considered these items "a cost of doing business", they were reluctant and usually refused to pay claims for these items without an itemized invoice for each vehicle repair order.

Many collision repair technicians were unwilling to take valuable time away from actual repair to prepare these detailed invoices. As a result these items were often not invoiced and ultimately cost the body shop hundreds of dollars a week in lost revenue.

**With the help of FasTrack, these once profit draining parts can now become a source of additional income for your collision shop.**

The major benefit of the FasTrack system is its **ability to create the accurate and detailed invoices** required by the insurance companies. Invoices can be customized to include the collision shop's logo for a more professional appearance. Once created, this logo will also appear on the FasTrack main menu screen.

FasTrack includes an **extensive database of every Auveco part commonly used in auto body repair.** The FasTrack database includes detailed information about every item as well as applicable OEM numbers and OEM list pricing. **FasTrack is the only software of this type offering OEM based pricing!** Auveco strives to be on the cutting edge of the body repair business. As new products are added to the already extensive Auveco product line, they are also added to the FasTrack database through **timely updates**, which are made available to active licensed users.

FasTrack is equipped with an **inventory tracking system** that allows the collision shop manager to enter initial inventories and to set up reorder points for replenishing stock in a timely manner. This system can also be used to track and invoice non-Auveco parts used in your body shop, such as adhesives, and cleaners.

Want to track your custom items? FasTrack lets you print your own bar code labels on standard label stock!

FasTrack also has a number of **built-in search utilities where** you may quickly look up any part by Auveco number, the OEM part number, your reference number or by any keyword related to the part. There are also many reports available through FasTrack. Besides the printed invoice, **there are reports to track profitability, sales by technician, inventory reports, sales by insurance company, inventory by location, etc.**

The FasTrack software includes utilities that will allow almost any Windows compatible printer to produce **custom bar code bin labels.** Once an item is entered into the FasTrack system, bar code labels can be printed onto standard size label stock by simply going to the database and indicating the part numbers that require labels. You may also print labels for your own unique numbering system or any items you have added to the FasTrack database.

Through the use of the **FT-SCAN portable data collection device, your technicians can now enter FasTrack invoicing information quicker than ever.** The FT-SCAN (available for an extra cost) is a powerful laser-scanning device built into a hand-held computer. The technician simply scans the repair order number his technician ID, the bin labels and enters the quantity. Connect the unit to the PC, transfer the data, and let FasTrack do the rest!

**Auveco's FasTrack for Windows software is offered only through qualified Auto Vehicle Parts Company distributors.** If you are interested in purchasing FasTrack for your operation, contact your local Au-ve-co distributor. For a distributor in your area call customer service @ 1-800-354-9816 extension #1.



# Apparel And Promotional Items



**30000** **Papermate Dynagrip Ball Point Pen**  
White barrel with forest green logo



**30086** **Galaxy Series Cap-Action Ball Point Pen**  
White & gold with green logo



**30087** **Rubber Grip Ball Point Pen**  
Silver with green logo



**30085** **Post-It® Yellow Note Pads**  
3" x 4", 50 sheets per pad  
**Without** Auveco phone & fax numbers  
**30089** **With** Auveco phone & fax numbers



**30088** **Collapsible Koozie Beverage Insulator**  
Folds flat to fit in your pocket, purse, etc.  
Green with white logo



**30017** **Koozie Chair Cooler**  
Black tubular steel frame chair with the convenience of a watertight Kooler compartment that holds 12 cans and more. Mesh pocket on back. Size: 13" x 15" x 11-1/2". Holds 250 lbs. Green with white Auveco logo



**30005** **High Impact Plastic 16 oz. Traveler Mug**  
Fully foam insulated with close lid. Harvest Green with white logo.



**30016** **Stainless Steel 16 oz. Mug**  
Dual wall insulation keeps drinks hot or cold. Closer lid prevents spills. Comfort-Grip handle with rubberized overcoat. Green logo



**30006** **12 oz. Coffee Mug**  
Marble ironstone. Green with white logo



**30011** **Titleist DT Golf Balls**  
1 dozen, solid core, maximum distance & feel. With green logo.



**30015** **Golf Bag Umbrella**  
Protect your golf bag & golf clubs from the rain. Multiple locking section in the shaft allows you to open the umbrella to three different lengths. Built-in spring on the shaft allows easy access to your clubs while the umbrella remains in the bag. Simply bend the umbrella from the top, and remove your club. Umbrella returns to original upright position once released.



**30013** **Wall Clock**  
Quartz movement, gold tone with imprinted dial, 11" diameter



**30065 Cool Color Sign Wave 24 Plus CD Case**  
 Hunter green and black with white logo  
 Anti-static sleeves hold 24 CDs & Disks, mesh pockets on inside front



**30060 Structured Cap With Adjustable Strap**  
 Green bill & top. Natural cap. One size  
 Embroidered logo on front. "The Complete Fastener Line" across the back.



**30059 Unstructured Cap With Adjustable Strap**  
 Green bill with khaki cap. One size  
 Embroidered logo on front "The Complete Fastener Line" across the back



**30061 Unstructured Cap With Adjustable Strap**  
 Sanded cap & bill with green trim. Low profile crown. One size  
 Embroidered logo on front. "The Complete Fastener Line" across the back.



**30076 Unstructured Cap With Adjustable Strap**  
 Green cap and bill with contrasting stone underbill. Low profile fit. One size. Embroidered logo & "Since 1916" on front.  
 "The Complete Fastener Line" across the back



**30051 100% Cotton, Pique Knit Sport Shirt**  
 Forest green with white embroidered logo  
 Left chest: Logo & "Since 1916"  
 Left sleeve: "The Complete Fastener Line"  
 S, M, L, XL, XXL, XXXL



**30052 100% Cotton, Pique Knit Sport Shirt**  
 White with forest green embroidered logo  
 Left chest: Logo & "Since 1916"  
 Left sleeve: "The Complete Fastener Line"  
 S, M, L, XL, XXL, XXXL



**30071 100% Cotton, Pique Knit Sport Shirt**  
 Chino with green embroidered logo  
 Left chest: Logo & "Since 1916"  
 Left sleeve: "The Complete Fastener Line"  
 S, M, L, XL, XXL, XXXL



**30077 100% Cotton, Pique Knit Sport Shirt**  
 Yellow with green embroidered logo  
 Left chest logo & "Since 1916"  
 Left sleeve "The Complete Fastener Line"  
 S, M, L, XL, XXL, XXXL



**30053 Port Authority Long Sleeve Denim Shirt**  
 100% Cotton, mid-weight shirt  
 Faded denim. Hunter green embroidered logo. Left chest: logo & "The Complete Fastener Line" "Since 1916"  
 S, M, L, XL, XXL, XXXL



**30078 Port & Co. Short Sleeve Denim Shirt**  
 100% Cotton Faded denim. White embroidered logo  
 Left chest: logo & "The Complete Fastener Line", "Since 1916"  
 S, M, L, XL, XXL, XXXL



**30062 Port Authority Long Sleeve Weathered Twill Shirt**  
 Forest (green) with white embroidered logo.  
 Left chest: logo & "The Complete Fastener Line" "Since 1916"  
 S, M, L, XL, XXL, XXXL



**30079 Port Authority Twill Shirt Short Sleeve**

Navy blue with white embroidered logo. Left chest: logo & "The Complete Fastener Line" "Since 1916"  
S, M, L, XL, XXL, XXXL



**30066 Port Authority Long Sleeve Oxford Shirt**

Blue with green embroidered logo. Left chest: logo & "The Complete Fastener Line" "Since 1916"  
S, M, L, XL, XXL, XXXL



**30067 Port Authority Long Sleeve Oxford Shirt**

White with green embroidered logo. Left chest: logo & "The Complete Fastener Line" "Since 1916"  
S, M, L, XL, XXL, XXXL



**30068 Port Authority Long Sleeve Signature Yarn Dyed Pattern Shirt**

Charcoal/Green yarn dyed pattern woven into this shirt is clear close-up; from a distance a unique muted appearance is achieved. Left chest: green logo & The Complete Fastener Line "Since 1916"  
S, M, L, XL, XXL, XXXL



**30069 Port Authority Long Sleeve Signature Peached Yarn Dyed Poplin Check Shirt**

Blue/White check pattern. Left Chest: green embroidered logo & The Complete Fastener Line "Since 1916"  
S, M, L, XL, XXL, XXXL



**30081 Port Authority Ladies Signature Cool Mesh Sport Shirt**

Apricot with white embroidered logo "Since 1916" on the left sleeve  
S, M, L, XL, P1, P2



**30080 Devon & Jones Bahama Camp Shirt**

Stone with white embroidered logo & "Since 1916" on the left sleeve  
S, M, L, XL, XXL, XXXL



**30063 Port Authority Interlock Knit Mock Turtleneck Shirt**

100% Cotton. Cover-seamed neck. Spandex in the collar & cuffs. White with green embroidered logo. Left chest: logo & "The Complete Fastener Line" "Since 1916"  
S, M, L, XL, XXL, XXXL



**30070 Port Authority Interlock Knit Mock Turtleneck Shirt**

100% Cotton. Cover-seamed neck. Spandex in the collar & cuffs. Green with white embroidered logo. Left chest: logo & "The Complete Fastener Line" "Since 1916"  
S, M, L, XL, XXL, XXXL



**30073 Jerzees 8 Oz. Sweatshirt**  
 50/50 poly cotton  
 Nu/blend fleece.  
 Ribbed Lycra in cuffs  
 collar & waistband  
 Green with white  
 embroidered logo.  
 Left chest: logo &  
 "The Complete Fastener Line"  
 "Since 1916"  
 S, M, L, XL, XXL, XXXL



**30074 Jerzees 8 Oz. Sweatshirt**  
 50/50 poly cotton  
 Nu/blend fleece.  
 Ribbed Lycra in cuffs  
 collar & waistband  
 Oxford (gray) with green  
 embroidered logo.  
 Left chest: logo &  
 "The Complete Fastener Line"  
 "Since 1916"  
 S, M, L, XL, XXL, XXXL



**30075 Port Authority Full Zip 9 oz. Sweatshirt**  
 60/40 cotton polyester blend.  
 Rib knit cuffs & waistband.  
 Front slash pockets and antique  
 brass finished zipper.  
 Charcoal with white  
 embroidered logo.  
 Left chest: logo &  
 "The Complete Fastener Line"  
 "Since 1916"  
 S, M, L, XL, XXL, XXXL



**30056 100% Cotton, 6.1 Oz. Hanes Beefy T-Shirt**  
 White with green logo.  
 Left chest: logo & "Since 1916"  
 Left sleeve: "The Complete  
 Fastener Line"  
 S, M, L, XL, XXL, XXXL



**30057 100% Cotton, 6.1 Oz. Hanes Beefy T-Shirt**  
 Green with white logo  
 Left chest: logo & "Since 1916"  
 Left sleeve: "The Complete  
 Fastener Line"  
 S, M, L, XL, XXL, XXXL



**30058 100% Cotton, 6.1 Oz. Hanes Beefy T-Shirt**  
 Ash with green logo  
 Left chest: logo & "Since 1916"  
 Left sleeve: "The Complete  
 Fastener Line"  
 S, M, L, XL, XXL, XXXL



**30082 100% Cotton, 6.1 Oz. Hanes Beefy T-Shirt**  
 Navy blue with white logo  
 Left chest: logo & "Since 1916"  
 Left sleeve: "The Complete  
 Fastener Line"  
 S, M, L, XL, XXL, XXXL



**30083 100% Cotton, 6.1 Oz. Hanes Beefy T-Shirt**  
 Yellow with green logo  
 Left chest: logo & "Since 1916"  
 Left sleeve: "The Complete  
 Fastener Line"  
 S, M, L, XL, XXL, XXXL



**30084 100% Cotton, 6.1 Oz. Hanes Beefy T-Shirt**  
 Red with white logo  
 Left chest: logo & "Since 1916"  
 Left sleeve: "The Complete  
 Fastener Line"  
 S, M, L, XL, XXL, XXXL



**30064 Port Authority Crew Jacket**  
 Hunter green 100% Taslan  
 nylon (water repellent) outside  
 shell. Gray poly-filled nylon  
 sleeves & fleece body lining  
 for warmth. Left chest: white  
 embroidered logo & "The Complete  
 Fastener Line" "Since 1916"  
 S, M, L, XL, XXL, XXXL